

National Aeronautics and
Space Administration



EXPLORE SCIENCE

Exploration Science Strategy and Integration Office (ESSIO)

Brad Bailey on behalf of Joel Kearns
Deputy Associate Administrator for Exploration
Science Mission Directorate

Planetary Advisory Committee
November 15, 2021

Vision

Define and lead the science strategy for Artemis and Moon to Mars

Exploration science integration between SMD Divisions, SMD/STMD/HEOMD, other government agencies, and international partners

Promote a lunar economy to produce rapid, frequent, and affordable access to the lunar surface and cislunar space

ESSIO Org. Chart

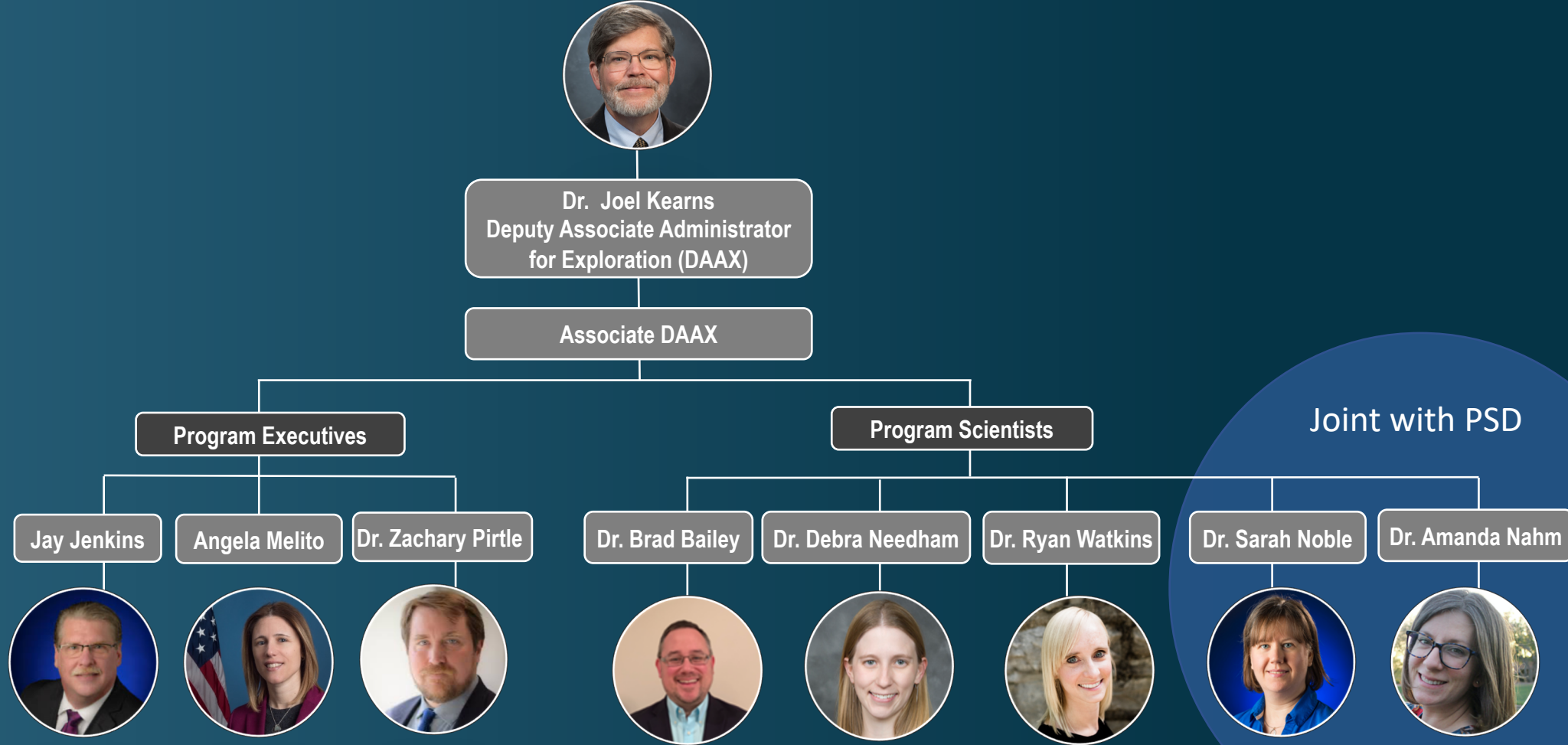

Outline

- LSSW update
- CLPS update
- Upcoming calls
- Science updates
 - LRO
 - ANGSA

Lunar Surface Science Workshop Schedule

Previous sessions:

- Overview and Background (May 2020)
- Tools and Instruments (May 2020)
- Volatiles (July 2020)
- Samples (July 2020)
- Dust and Regolith (August 2020)
- Planetary Protection (September 2020)
- The Value of Mobility (October 2020)
- Foundational Data Products (November 2020)
- Space Biology (January 2021)
- Structuring Real-Time Science Support of Artemis Crewed Operations (February 2021)
- Progress and Challenges: Updates from NASA HQ and Artemis (April 2021)
- Physical Sciences (August 2021)
- Science with Robotic Arms (September 2021)

Check out the updates to the website:

<https://lunarscience.arc.nasa.gov/lssw>

Upcoming Sessions:

- November 18th
 - Future CLPS landing sites
- January 26th-27th
 - Inclusive Lunar Exploration
 - Abstracts due tomorrow!
- February TBD
 - Heliophysics

CLPS Deliveries

2022-2025

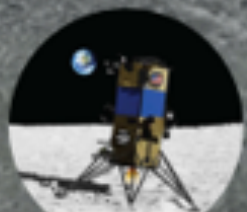

Delivery Site: Oceanus Procellarum
Provider: Intuitive Machines (IM)
Task Order (TO)2-IM | Q1 2022



Delivery Site: Lacus Mortis
Provider: Astrobotic
TO2-AB | 2022

Delivery Site: Gruithuisen Domes
Provider: TBD
PRISM 2a/CP-21 | 2025



Delivery Site: Mare Crisium
Provider: Firefly
TO19D | Q3 2023

Delivery Site: Reiner Gamma
Provider: TBD
PRISM 1a/CP-11 | 2024



Delivery Site: South Pole
Provider: IM
TO PRIME-1 | Nov 2022



Delivery Site: South Pole
Provider: Astrobotic
VIPER | Nov 2023



Delivery Site: South Pole
Provider: Masten
TO19C | Nov 2023

Delivery Site: Schrödinger Basin
Provider: TBD
PRISM 1b/CP-12 | 2025

Delivery Site: South Pole
Provider: TBD
PRISM 2b/CP21 | 2025

Innovative Science Deliveries to the Moon



SCHEDULE-DRIVEN
Get to the lunar surface quickly and conduct science

NPLP, LSITP

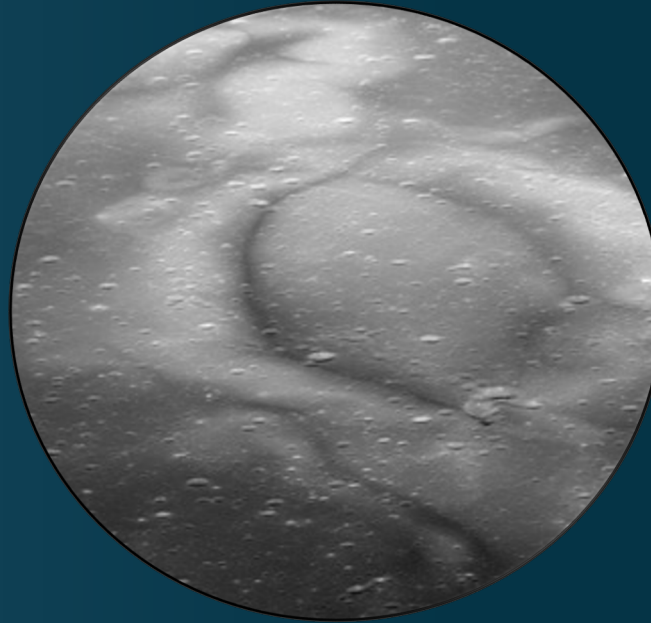

SCIENCE-DRIVEN
Achieve high-priority science objectives across the lunar surface

DALI, PRISM



INCREASED CAPABILITIES
Promote development of advanced technology that enhances science return across the lunar surface

PRISM-1 Selections

Instrument suite selections announced for *Payloads and Research Investigations on the Surface of the Moon* (PRISM-1)

- Lunar Vertex | PI: D. Blewett (APL)
- Farside Seismic Suite (FSS) | PI: M. Panning (JPL)
- Lunar Interior Temperature and Materials Suite (LITMS) | PI: R. Grimm (SwRI)

PRISM-1 delivery sites

- PRISM 1a: Lunar Vertex will land at Reiner Gamma, a lunar swirl feature on the near side
 - Planetary decadal science: understand how lunar surface has been modified by geological processes within a lunar magnetic anomaly and determine the origin of magnetized crust
- PRISM 1b: FSS and LITMS will land at Schrödinger Basin, the first CLPS lunar farside delivery
 - Planetary decadal science: characterize differentiation and evolution of the Moon's interior using geophysical techniques

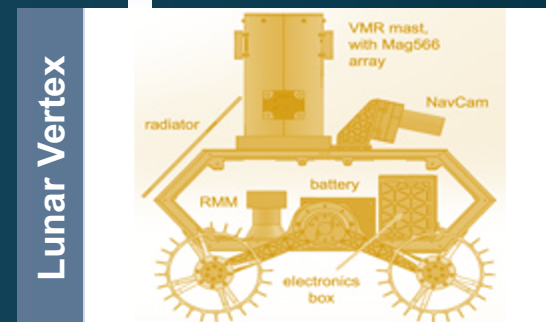
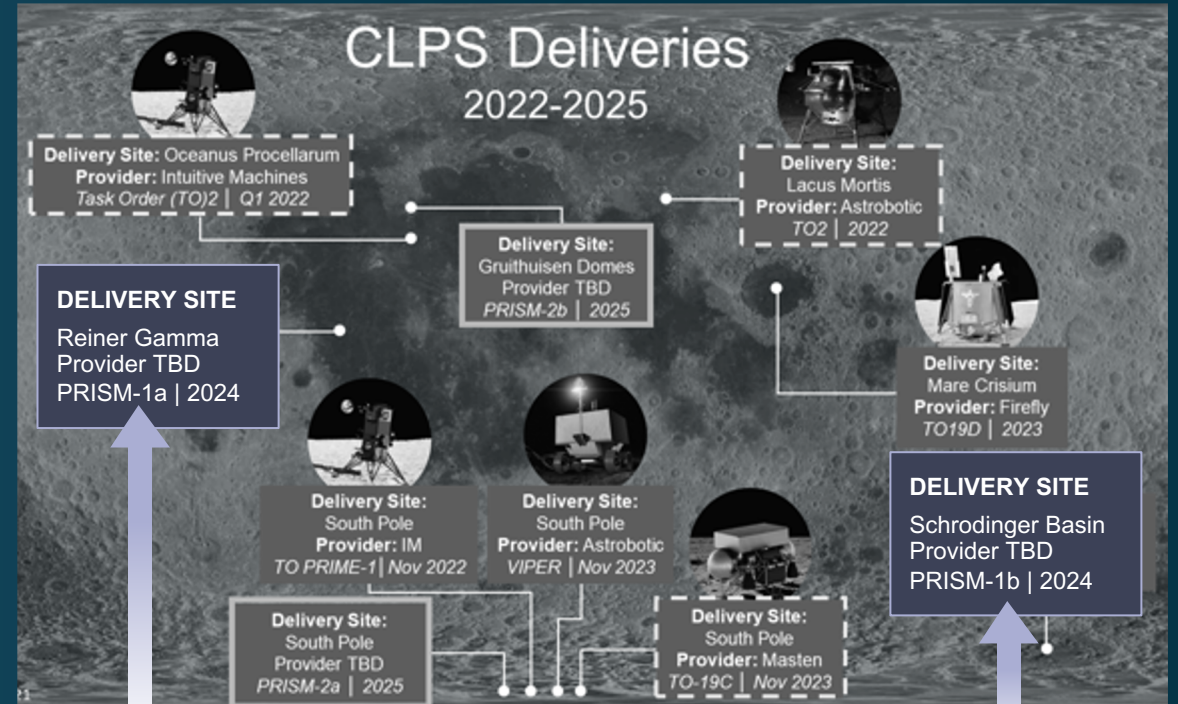

Lunar Vertex: lunar magnetic anomalies and plasma environment (Reiner Gamma)

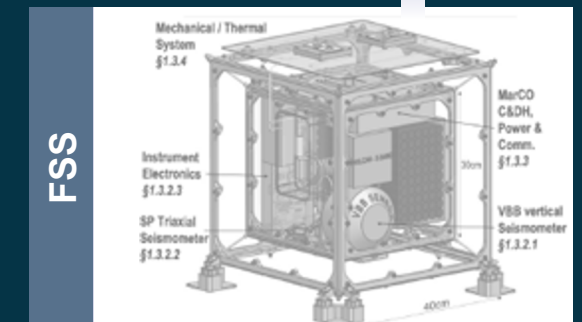

LITMS (not pictured above) & FSS: moonquakes, heat flow, interior and crustal structure (Schrödinger Basin)

PRISM-2

- PRISM-2 draft solicitation released in May
 - Step 1s received
- Deliveries planned for:
 - **Gruithuisen Volcanic Domes** (Q1 – Q2 2025)
 - Mobility provided
 - **South Pole** (Q4 2025 – Q1 2026)
 - Investigations should focus on environmental monitoring or biological sciences, as outlined in Artemis III SDT Objective 7
- At least 2 suites will be selected, one for each destination. More selections may be made based on available funding/mass.
- Early career proposers and first-time PIs welcomed and encouraged to propose!

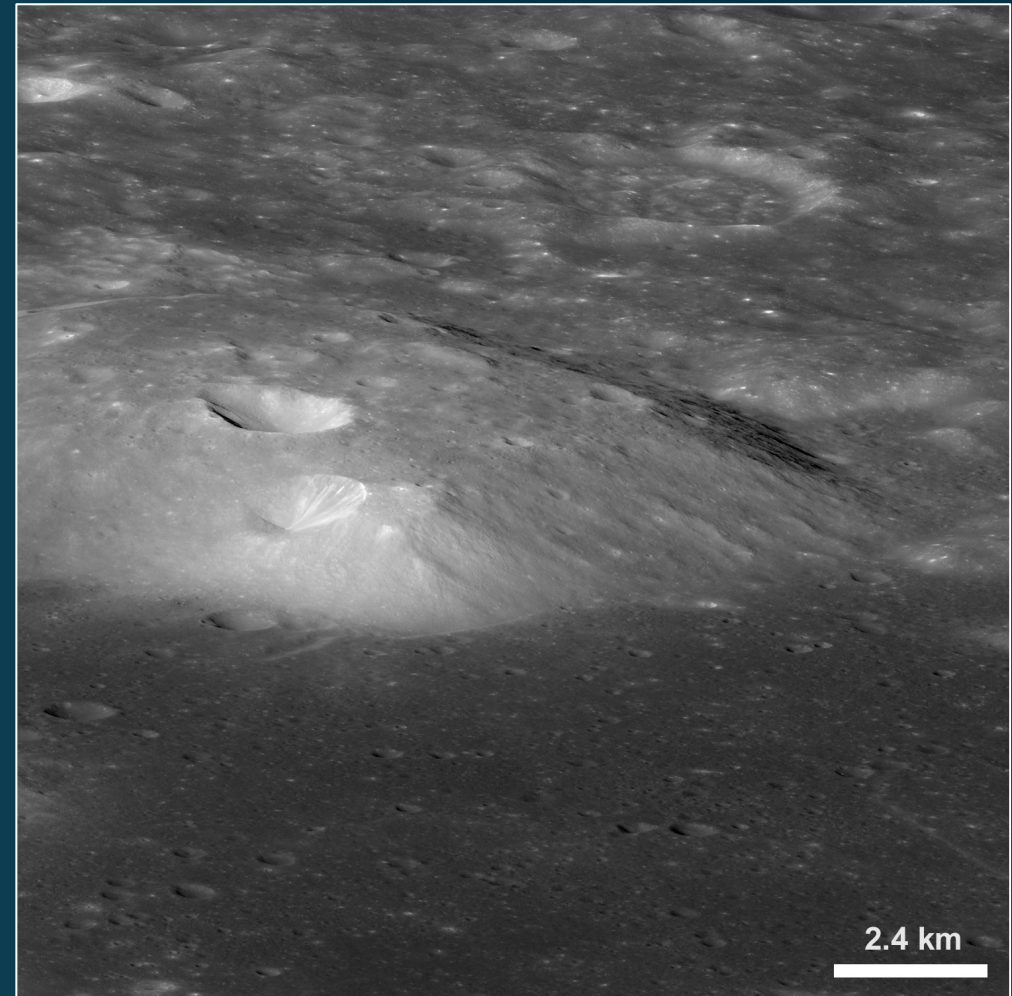

Future PRISM calls

- Annual PRISM calls
- Anticipate a PRISM-3 call next year for deliveries in the 2026 timeframe
- Considering a Stand Alone/Site Agnostic PRISM call for individual instruments that may be manifested on upcoming CLPS deliveries
- Lunar Surface Science Workshop session on landing sites will help guide selection of future CLPS landing sites and associated PRISM calls

Future Artemis Crewed Landing Mission Calls

- Deployed Instruments for Artemis III and V
 - Expect call next year
- Artemis III Geology Team
 - Expect call next year
 - Based on priorities in the SDT report
 - Expected in ROSES22
 - The geology team will have 3 components:
 - NASA internal roles
 - Expect to have a call for a small “core” team
 - Expected in ROSES22
 - Anticipate a participating scientist program, ~1 year prior to Artemis III launch
- Instruments for the Lunar Terrain Vehicle (LTV; teleoperated when no crew)

Analog Activities to Support Artemis Lunar Operations

- Looking for science team members to support D-RATS analog science operations for the 2022 deployment in Aug/Sept
- PSD call will be released soon through ROSES21
- Anticipate a similar call for the 2023 deployment



ANGSA

73002 Upper Drive tube

- Processing finishing up, remaining sample has been impregnated with epoxy for sectioning
- Samples distributed, first science results have been presented, more at AGU & LPSC

73001 Lower (sealed) Drive tube

- Piercing tool expected to be delivered by ESA to JSC this month
- Planning to extract the gas in December
- After gas extraction, XCT data will be collected
- Core extrusion expected in January

ANGSA 2.0 call expected next year



Lunar Reconnaissance Orbiter

- LRO instrument teams completed their 47th data delivery on September 15th, bringing the total data sent to the PDS to over 1.3 Petabytes. Over 60% of PDS holdings are data from the LRO mission.
- LRO is actively working on their 5th Extended Science Mission proposal, featuring investigations into volatiles, surface geology, as well as support for landing site characterization for future missions.
- On October 16 International Observe the Moon Night featured over 3900 events globally, on all seven continents (and in all 50 States). Organized by the LRO communications team, this year's event featured virtual gatherings, a NASA TV broadcast, and a viewing guide to help observers learn about the Moon.
- LRO is preparing the spacecraft for the November 19 partial lunar eclipse, where we will turn off all instruments in order to preserve our battery for the extended period of time we are in darkness.



This still is from a video published to support INOM, showing what the Earth looks like from a location near the lunar south pole.

The video is at:

https://svs.gsfc.nasa.gov/vis/a000000/a004900/a004944/shackleton_earth_1080p30.mp4

New craters named near the south pole – Henson, Marvin, and Spudis

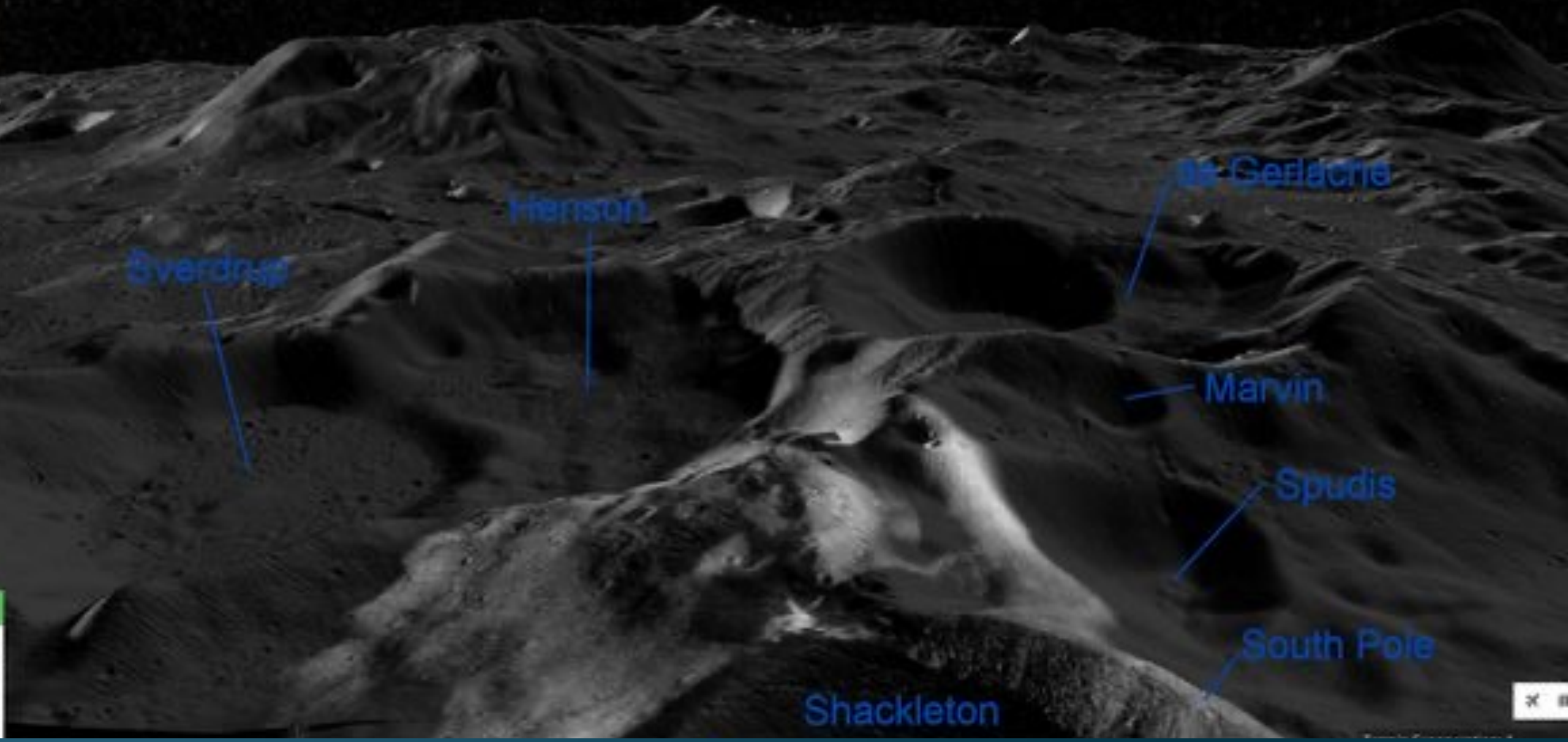



Questions

