

National Aeronautics and
Space Administration

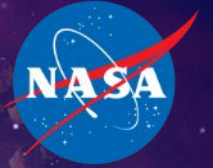

EXPLORE SOLAR SYSTEM & BEYOND

NASA Astrophysics Update

Astrophysics Advisory Committee

October 13 & 15, 2021

Paul Hertz

Director, Astrophysics Division

Science Mission Directorate

 [@NASAUniverse](https://twitter.com/NASAUniverse) [@NASAEoplanets](https://twitter.com/NASAEoplanets)

Hubble & Swift Detect a New Type of Supernova

Released: June 28, 2021



SCIENCE
HIGHLIGHT

Hubble image of Galaxy NGC 2146



Credits:
NASA/STScI/
J. DePasquale,
S. Wilkinson, and
Las Cumbres
Observatory; and
Nature Astronomy

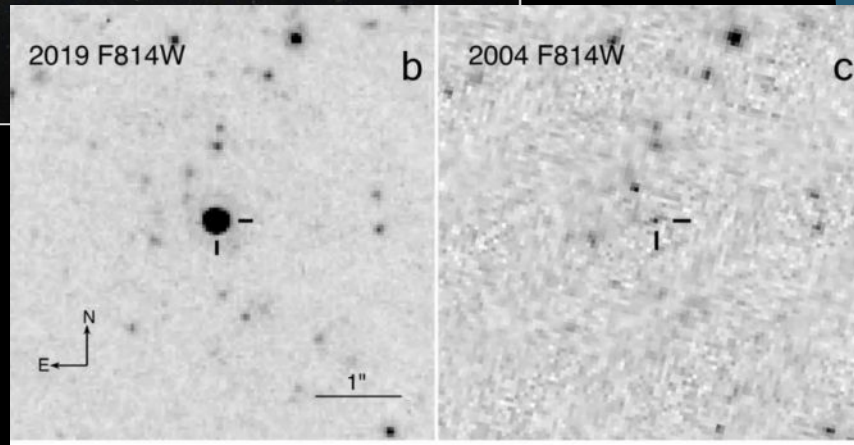

Hubble images of star after (left) and before (right) the supernova explosion.

- Using data from the Hubble Space Telescope and the Neil Gehrels Swift Explorer, among many telescopes, scientists have identified for the first time a new, third type of supernova.
- The “electron capture” supernova explosion likely spawned from an intermediate mass red giant star 8-10 times the mass of the Sun.
- Instead of dying in superbright explosions like larger stars with an iron core, or like smaller white dwarf stars that accrete material from a companion, these intermediate mass stars spawn a lower energy explosion when electrons in the stellar core are “captured” by atoms like Mg and Ne, reducing electron pressure and creating instability.

Astronomers Find a 'Break' in One of the Milky Way's Spiral Arms

Released: August 17, 2021

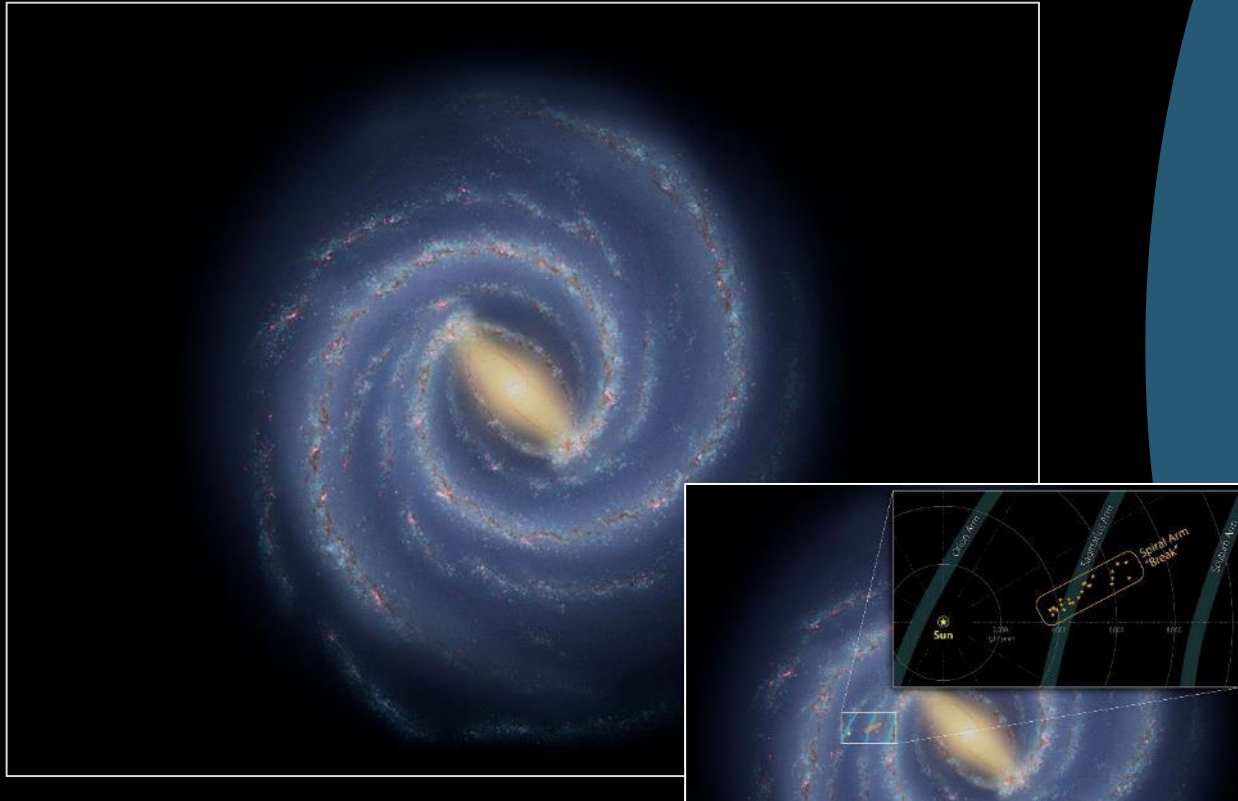

This illustration shows astronomers' current understanding of the large-scale structure of the Milky Way. Stars and star-forming regions are largely grouped into spiral arms. Measuring the shape, size, and number of spiral arms is a challenge because Earth is located inside the galaxy. Credit: NASA/JPL-Caltech



SCIENCE
HIGHLIGHT

- Scientists have spotted a previously unrecognized feature of our Milky Way galaxy: A contingent of young stars and star-forming gas clouds is sticking out of one of the Milky Way's spiral arms. Similar structures – sometimes called spurs or feathers – are commonly found jutting off the arms of other spiral galaxies. Stretching some 3,000 light-years, this is the first major structure identified with an orientation so dramatically different than the arms.
- Astronomers have a rough idea of the size and shape of the Milky Way's arms, but much remains unknown: They can't see the full structure of our home galaxy because Earth is inside it.
- To learn more, the authors of the new study focused on a nearby portion of one of the galaxy's arms, called the Sagittarius Arm. Using NASA's Spitzer Space Telescope prior to its retirement in January 2020, they sought out newborn stars, nestled in the gas and dust clouds (called nebulae) where they form. Spitzer detects infrared light that can penetrate those clouds.
- To get a 3D view of the arm segment, the scientists used the latest data release from the ESA Gaia mission to measure the precise distances to the stars. The combined data revealed that the long, thin structure associated with the Sagittarius Arm is made of young stars moving at nearly the same velocity and in the same direction through space.
- The newly discovered feature contains four nebulae known for their beauty: the Eagle Nebula, the Omega Nebula, the Trifid Nebula, and the Lagoon Nebula. In the 1950s, a team of astronomers made rough distance measurements to some of the stars in these nebulae and were able to infer the existence of the Sagittarius Arm. Their work provided some of the first evidence of our galaxy's spiral structure.

SCIENCE 2020-2024: A Vision for Scientific Excellence

VISION

Lead a globally interconnected program of scientific discovery that encourages innovation, positively impacts people's lives, and is a source of inspiration

MISSION

Discover the secrets of the universe

Search for life elsewhere

Protect and improve life on Earth and in Space

VALUES

Excellence

Inclusion

Leadership

Integrity

Teamwork

Safety

PRIORITIES

Exploration and Scientific Discovery

Innovation

Interconnectivity and Partnerships

Inspiration



Science 2020-2024: A Vision for Science Excellence
<https://science.nasa.gov/about-us/science-strategy>

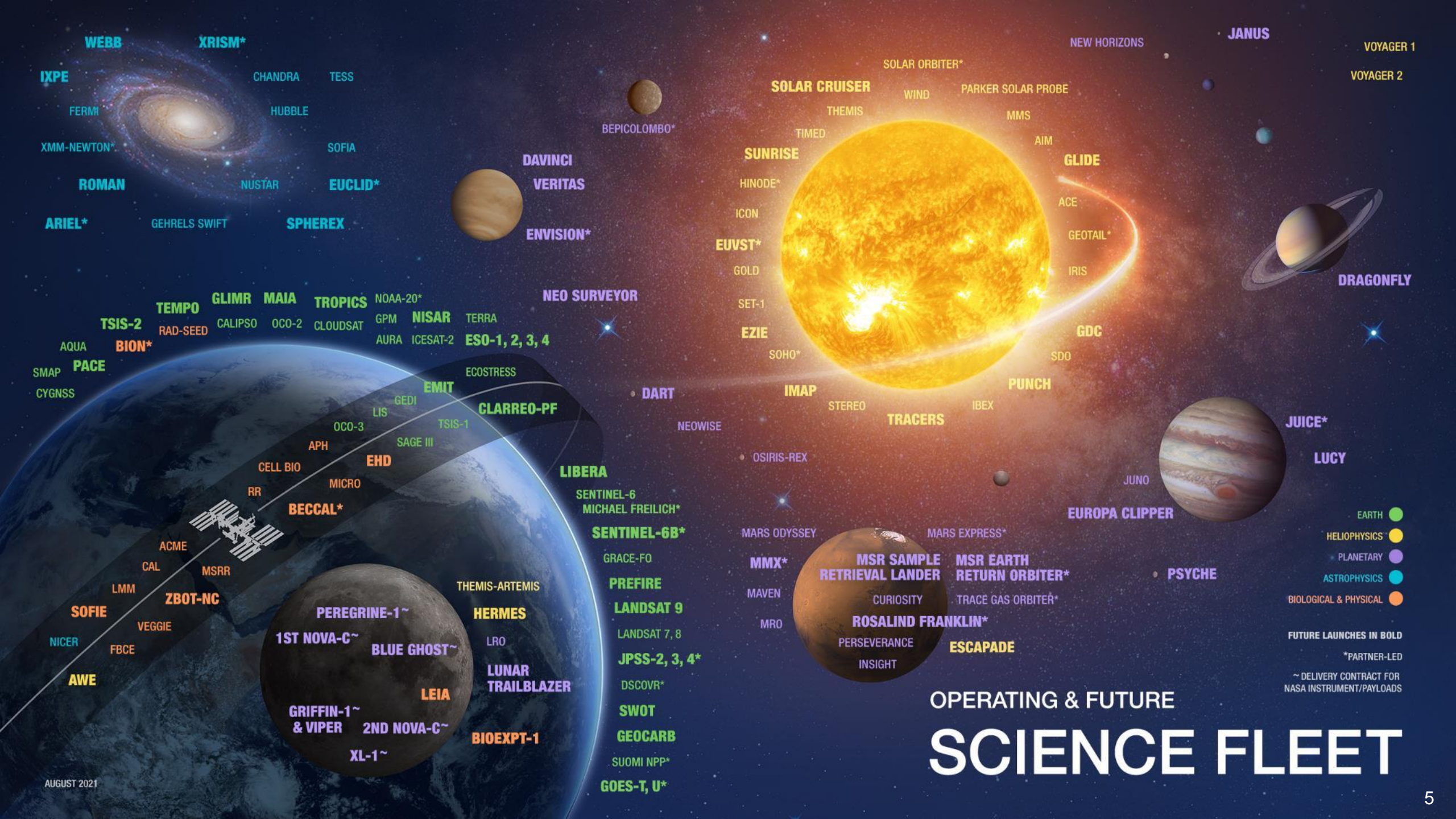

WEBB **XRISM*** **CHANDRA** **TESS** **NEW HORIZONS** **JANUS** **VOYAGER 1**
IXPE **FERMI** **HUBBLE** **BEPICOLOMBO*** **VOYAGER 2**
XMM-NEWTON* **SOFIA** **DAVINCI** **VERITAS**
ROMAN **NUSTAR** **EUCLID*** **ENVISION***
ARIEL* **GEHRELS SWIFT** **SPHEREX**

NOAA-20* **NEO SURVEYOR**
TSIS-2 **TEMPO** **GLIMR** **MAIA** **TROPICS** **GPM** **NISAR** **TERRA**
AQUA **BION*** **RAD-SEED** **CALIPSO** **OCO-2** **CLOUDSAT** **AURA** **ICESAT-2** **ESO-1, 2, 3, 4**
SMAP **PACE** **ECOSTRESS**
CYGNSS **EMIT** **CLARREO-PF**
LIS **GEDI** **OCO-3** **SAGE III** **TSIS-1**
APH **EHD**
CELL BIO **MICRO**
RR **BECCAL***
ACME **MSRR**
CAL **ZBOT-NC**
LMM **SOFIE** **VEGGIE**
NICER **FBCE**
AWE **THEMIS-ARTEMIS**
PEREGRINE-1~ **HERMES**
1ST NOVA-C~ **BLUE GHOST~** **LRO**
GRIFFIN-1~ **LEIA** **LUNAR TRAILBLAZER**
& VIPER **2ND NOVA-C~**
XL-1~ **BIOEXPT-1**

SOLAR ORBITER* **SOLAR CRUISER** **WIND** **PARKER SOLAR PROBE**
THEMIS **MMS** **GLIDE**
TIMED **AIM**
SUNRISE **HINODE*** **ACE** **GEOTAIL***
ICON **IRIS**
EUVST* **GOLD** **SDO**
SET-1 **EZIE** **GDC**
SOHO* **IMAP** **PUNCH**
STEREO **TRACERS** **IBEX**
NEOWISE **OSIRIS-REX** **JUNO** **DRAGONFLY**
JUICE* **LUCY**
MARS ODYSSEY **MARS EXPRESS*** **EUROPA CLIPPER**
MMX* **MSR SAMPLE RETRIEVAL LANDER** **MSR EARTH RETURN ORBITER*** **PSYCHE**
MAVEN **CURIOSITY** **TRACE GAS ORBITER***
MRO **ROSA LIND FRANKLIN*** **ESCAPADE**
PERSEVERANCE
INSIGHT

- EARTH
- HELIOPHYSICS
- PLANETARY
- ASTROPHYSICS
- BIOLOGICAL & PHYSICAL

FUTURE LAUNCHES IN BOLD
 *PARTNER-LED
 ~ DELIVERY CONTRACT FOR NASA INSTRUMENT/PAYLOADS

OPERATING & FUTURE SCIENCE FLEET

FBCE
NG-16



LANDSAT 9

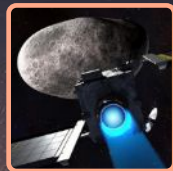

DART

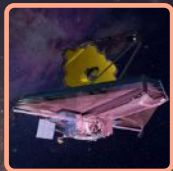

WEBB



PEREGRINE-1



1ST NOVA-C



BIO EXP-1
ARTEMIS 1

A YEAR OF SCIENCE



LUCY



IXPE



GOES-T



SOFIE
SPX-23



TROPICS

- LAUNCH
- DELIVERY
- LANDING
- DEPARTURE

Colorado Ultraviolet Transit Experiment (CUTE)



Grad Student Arika Egan (center) DeCicco (left) insert CUTE in launch canister at VAFB. Photo courtesy

Launched September 29, 2021
CUTE deployed, open

CUTECubeSat 🌞🌍🚀🇺🇸 Retweeted
 LASP @LASPatCU
 Quick update on @CUTECubeSat from the @LASPatCU SmallSat Mission Ops Center: we started the spacecraft checkouts yesterday & hope to begin the #science payload checks next week!
 #exoplanet #cubesat #hamradio #space



1:00 PM · Sep 29, 2021 · TweetDeck
 2 Retweets 21 Likes

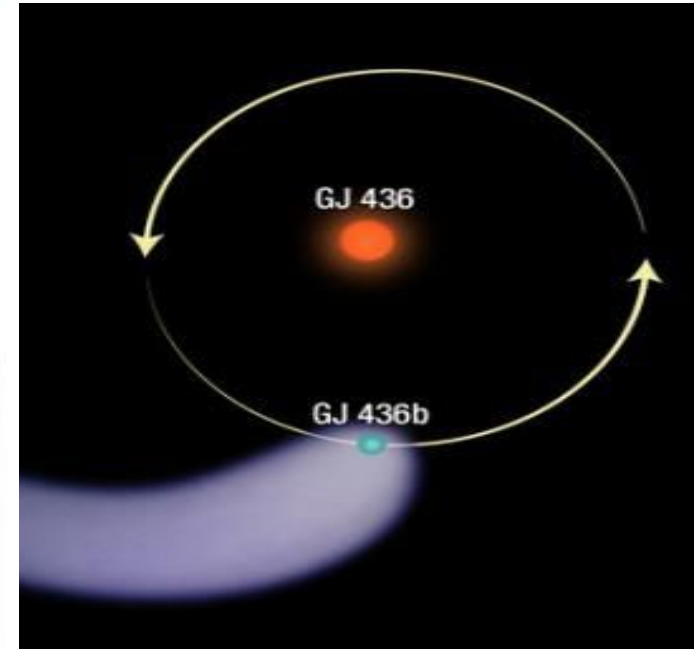

The Colorado Ultraviolet Transit Experiment will take multiple medium resolution UV observations during transit, in order to measure the atmosphere of the planet being ablated away. Magnetic fields are also being studied via the presence of tori or bow shocks.

Primary payload
 Deployed on the ground after launch

Balloon Program

Campaigns cancelled due to COVID-19: Spring 2020 (New Zealand), Summer 2020 (Palestine TX), Fall 2020 (Ft Sumner NM), Winter 2020 (Antarctica), Spring 2021 (New Zealand), and Winter 2021 (Antarctica)

Successfully demonstrated Return to Flight using COVID-safe procedures with Spring 2021 (Ft Sumner NM) campaign

Completed Fall 2021 (Ft Sumner NM) campaign:

- ✓ WHATS UP (Water Hunting Advanced Terahertz Spectrometer on an Ultra Small Platform)/ Tang/JPL/Planetary Science (H/L) ✓ Aug 20
- ✓ SLS (Submm Wave Limb Sounder)/Stachnik/JPL/Earth Sci ✓ Aug 28
- ✓ CSBF Engineering Test Flight (6 technologies)/Salter/CSBF ✓ Aug 30
- ✓ CSBF Engineering test Flight (1 technology)/Mullenax/CSBF ✓ Sep 6
- ✓ HASP (High Altitude Student Platform)/Guzik/LSU/ Education ✓ Sep 14
- ✓ REMOTE/Toon/JPL/Earth Science ✓ Sep 25
- ✓ Orion Eagle/Nowicki/LANL/LANL Technology (H/L) ✓ Sep 26
- × PICTURE C (Planetary Imaging Concept Testbed Using Recoverable Experiment)/Chakrabarti/UMASS/Astrophysics deferred to 2022

Planning for CY2022 includes:

- Spring 2022 (New Zealand)
- Spring 2022 (Sweden)
- Fall 2022 (Ft Sumner NM)
- Winter 2022 (Antarctica)

Fall 2021 Balloon Campaign is ongoing in Ft. Sumner, New Mexico



- Observatory integration and testing (I&T) completed in late September 2021
- IXPE Operational Readiness Review (ORR) scheduled for October 12-13, 2021
- Ship to Kennedy Space Center planned for mid-November 2021
- Current launch readiness date is December 9, 2021

Imaging X-ray Polarimetry Explorer (IXPE)

Credit: Ball Aerospace

Imaging X-ray Polarimetry Explorer

- IXPE Science Objectives:

- Use X-ray polarimetric imaging to examine directly the magnetic-field topology of AGN jets.
- Perform X-ray spectral polarimetry on microquasars.
- Perform X-ray polarimetric imaging and phase-resolved polarimetry to study radio pulsars and pulsar-wind nebulae.
- Use X-ray polarimetric imaging to examine the magnetic-field topology of SNR.
- Perform X-ray phase-resolved spectral polarimetry of accreting X-ray pulsars.
- Test QED by performing X-ray phase-resolved polarimetry of magnetars

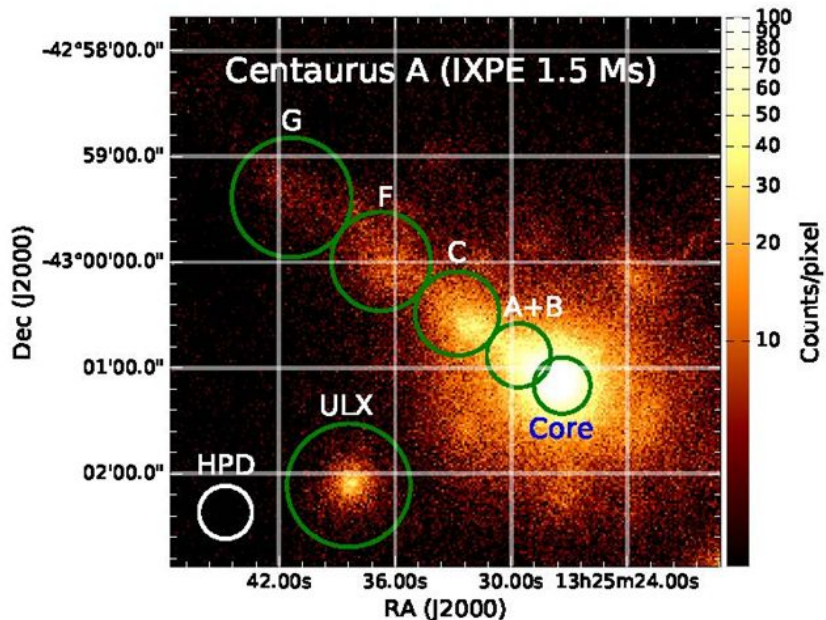

Overlay of IXPE polarimetric imaging fields (green) on the jet of Cen A.

- Data is immediately available to the public (no limited data access period).
- General Observer program will be added if there is an extended mission.

James Webb Space Telescope

Update from
Eric Smith
APAC Meeting Day 1



Shipping container, roll-over fixture and Webb at Northrop Grumman





James Webb Space Telescope

NASA's History Office conducted an exhaustive search through currently accessible archives on James Webb and his career. They also talked to experts who previously researched this topic extensively. NASA found no evidence at this point that warrants changing the name of the James Webb Space Telescope.

“We’ve found no evidence at this time that warrants changing the name of the James Webb Space Telescope.” -- Administrator Bill Nelson

NANCY GRACE ROMAN SPACE TELESCOPE

Mission passed Critical Design Reviews for Telescope, Wide Field Instrument, Coronagraph Instrument, Instrument Carrier, Ground System during past year.

Completed the Critical Design Reviews for the spacecraft and the entire mission on 27 September 2021.

Project continues to make progress in spite of COVID inefficiencies and supply chain impacts; cost and schedule commitments have been adjusted to accommodate.

NASA launch commitment date is May 2027.

Opportunities for participation in Roman Space Telescope research and support are offered in ROSES-2021.

Roman Mission Objectives

Wide Field Infrared survey

Imaging and spectroscopy to >26.5 AB mag

Expansion history of the Universe

Using supernova, weak lensing and galaxy redshift survey techniques

Growth of Structure in the Universe

Weak lensing, redshift space distortions and galaxy cluster techniques

Exoplanet Census

Statistical census of exoplanets from outer habitable zone to free floating planets

General Astrophysics Surveys

Devote substantial fraction of mission lifetime to peer reviewed program

Coronagraph technology demonstration

Demonstrate exoplanet coronagraphy with active wavefront control

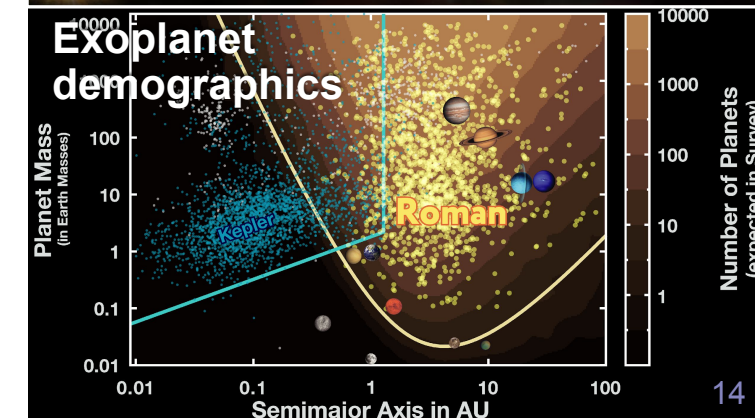
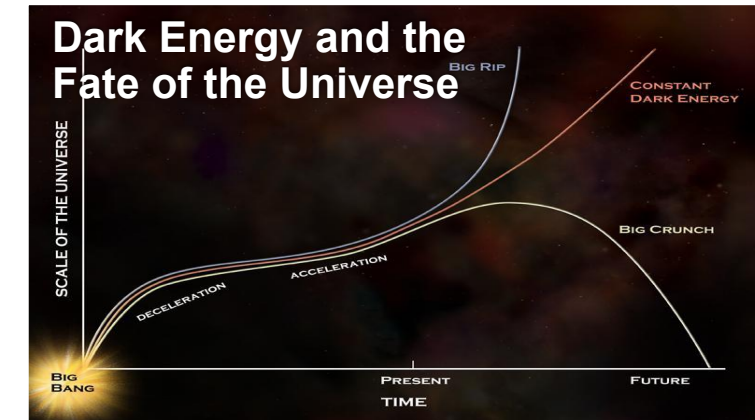
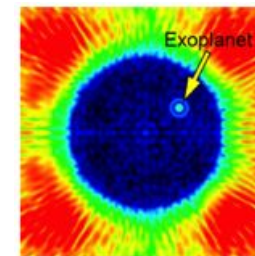

Roman Space Telescope Hardware

Status I: Telescope

Optical Telescope Assembly (L3Harris):

Successful telescope CDR in December 2020

Primary and secondary mirrors have been refigured, polished and coated; Coronagraph Instrument relay optics polished and coated; Wide Field Instrument relay optics all figured, polished and coated

Tertiary mirror structure fabricated

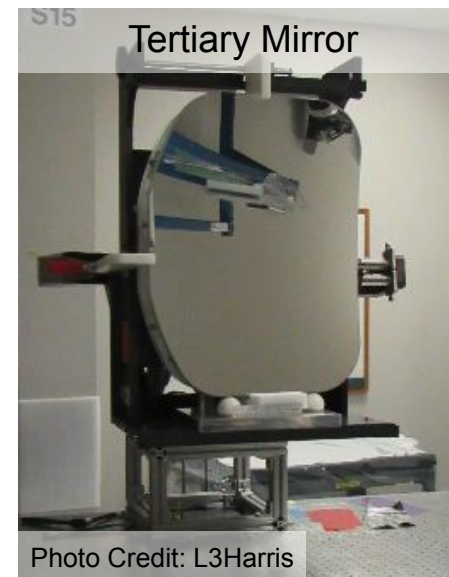
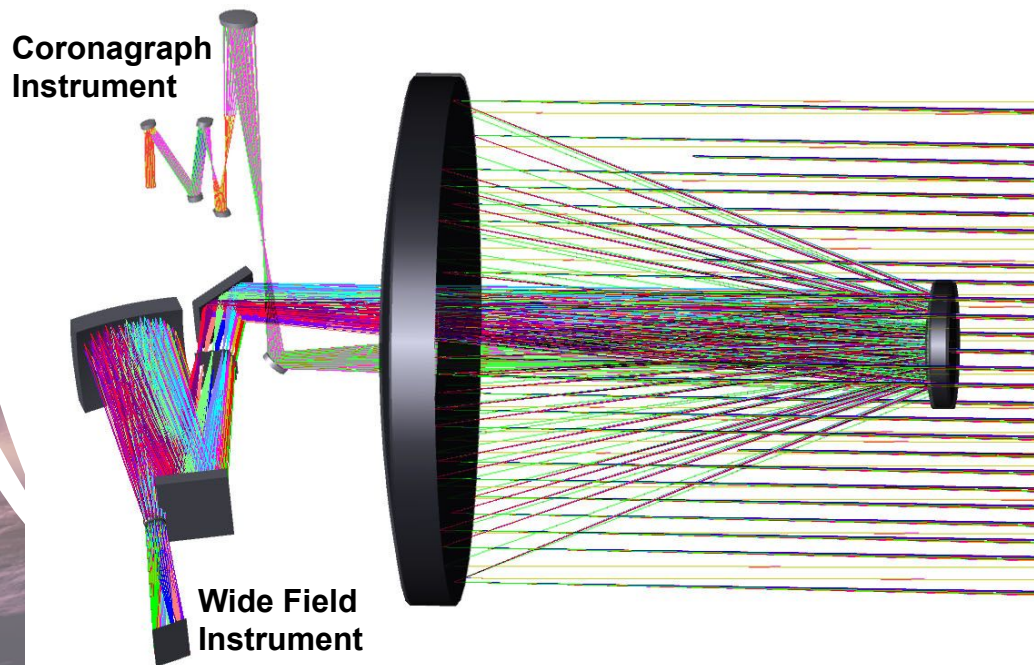

Roman Space Telescope Hardware Status II: Wide Field Instrument

Wide Field Instrument (Ball Aerospace & Goddard Space Flight Center):

Successful instrument CDR in January 2021

Focal plane array: 28 flight quality detectors (18 needed);
engineering focal plane built; tested with full readout signal chain

Relative Calibration System redesigned; engineering calibration
source in testing, flight components in hand or procured

Element wheel, filters, grism, prism have had engineering units
tested; flight units in fabrication

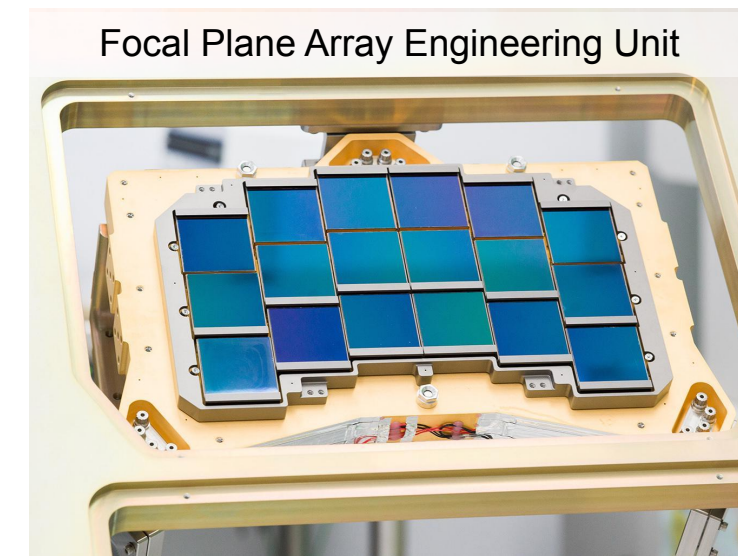
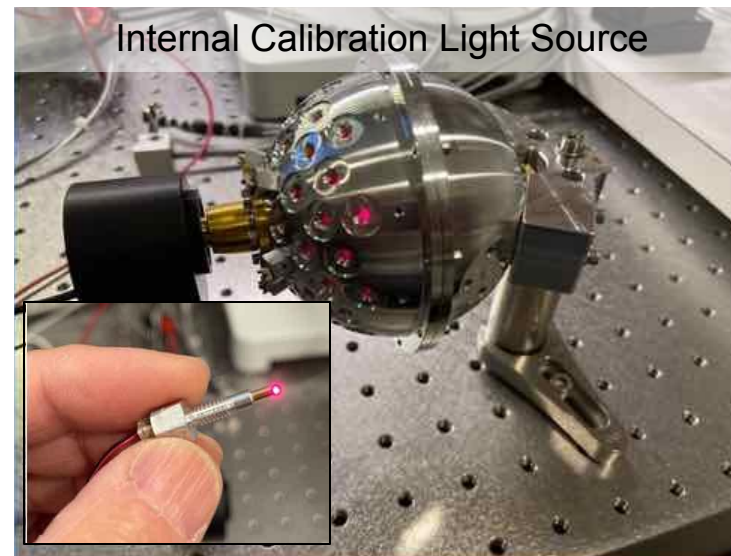
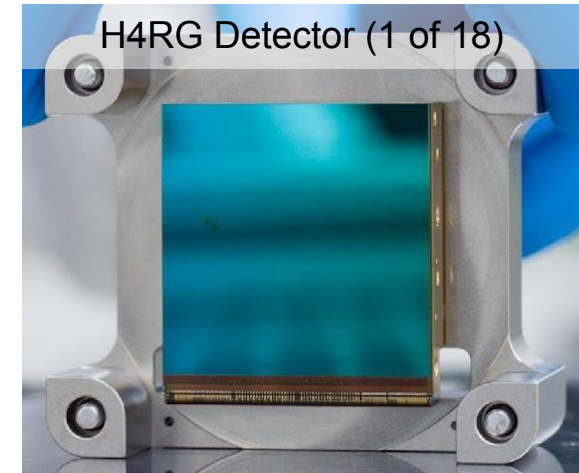

Roman Space Telescope Hardware Status III: Coronagraph

Coronagraph Instrument (Jet Propulsion Laboratory):

Successful telescope CDR in April 2021

>90% of flight hardware ordered, in work, or delivered by CDR

Flight mirror mechanisms, deformable mirror units, precision element alignment mechanisms (MPIA contribution), Hybrid Lyot masks & stops all in fabrication/testing; prisms/polarizers preparing for shipping (JAXA contribution); Photon counting CCDs in fabrication (ESA contribution); optics received (including CNES contribution)

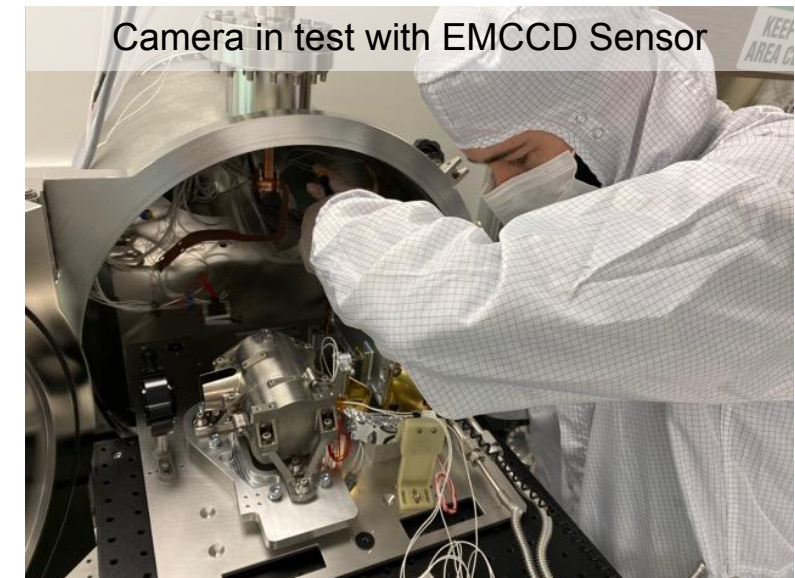
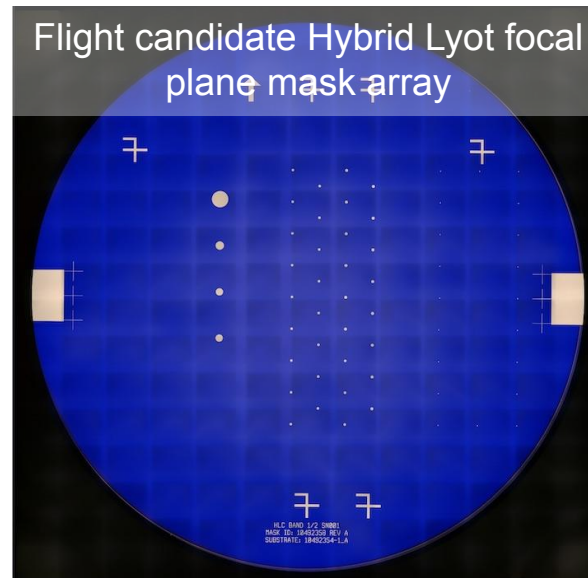
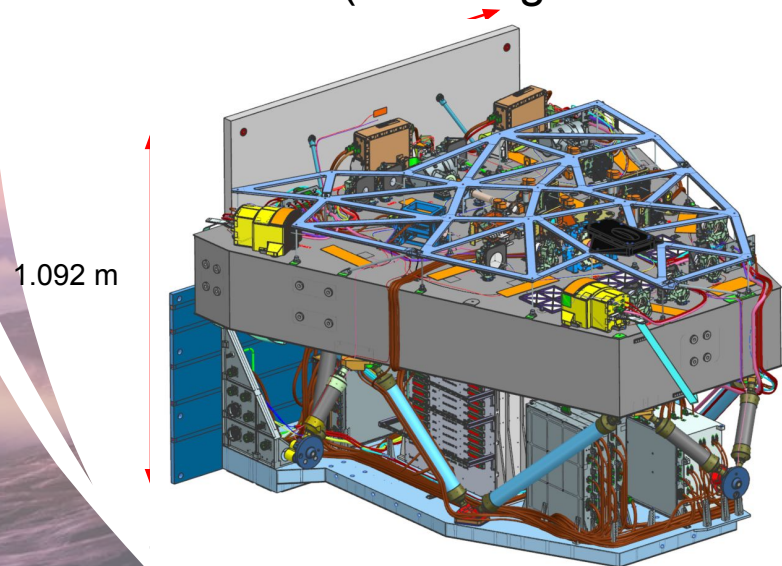
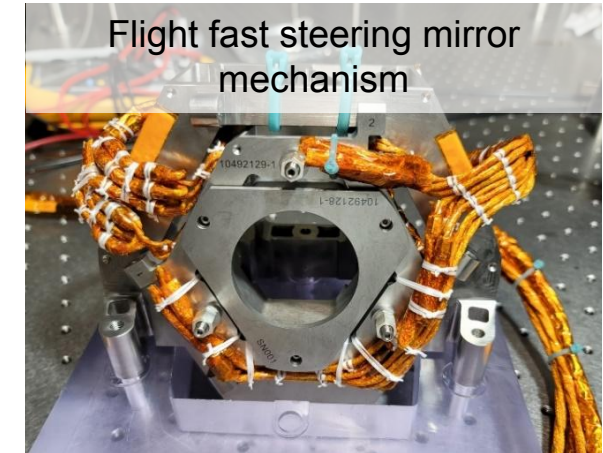

Roman Space Telescope Hardware Status IV: Instrument Carrier

Instrument Carrier (Northrop Grumman & Goddard Space Flight Center):

Successful CDR in September 2020

Most flight components in fabrication

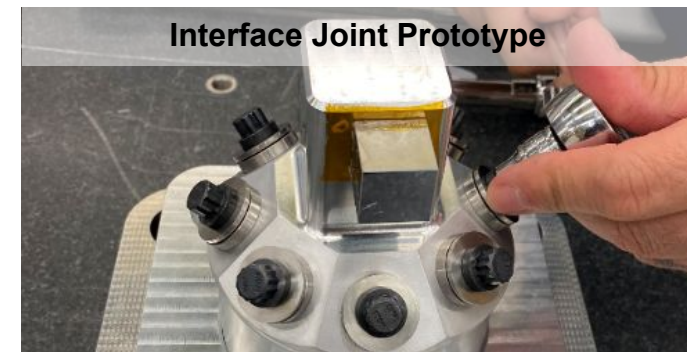
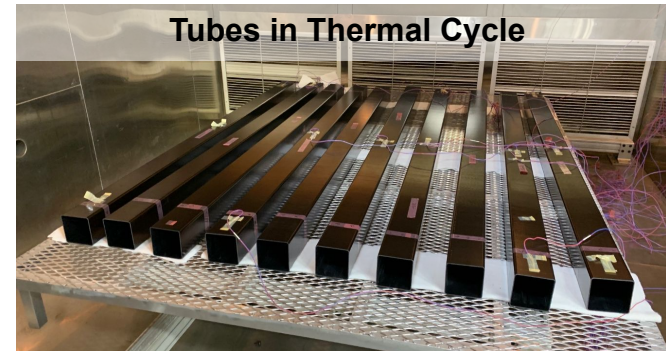
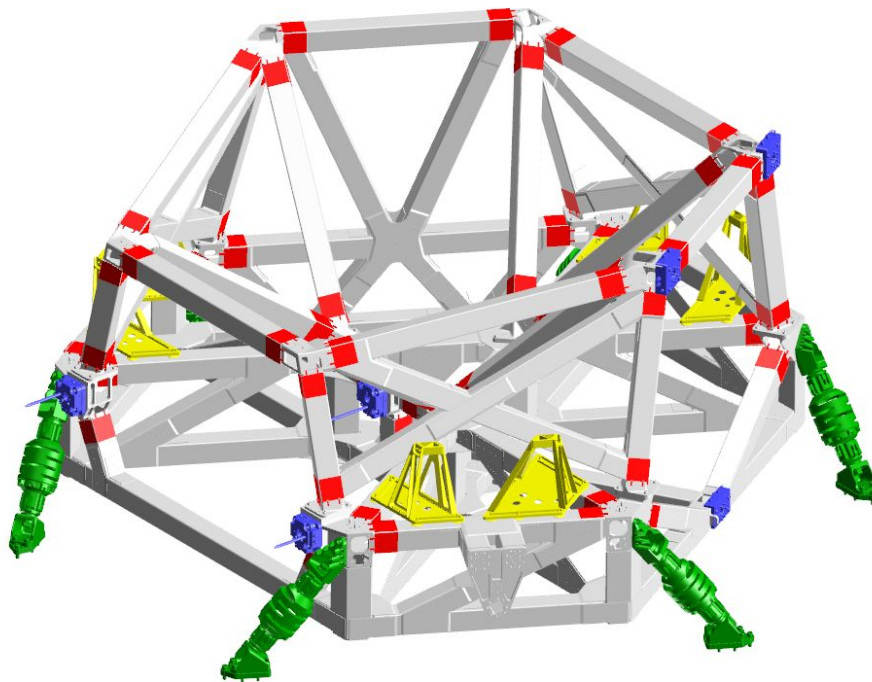

Roman Space Telescope Hardware Status V: Spacecraft

Spacecraft (Goddard Space Flight Center):

Completed CDR in September 2021

Engineering units for critical elements in testing

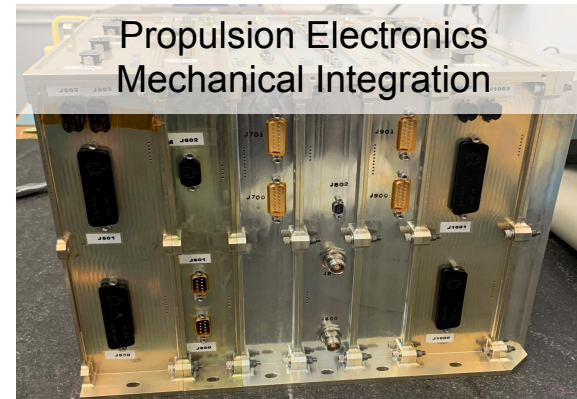
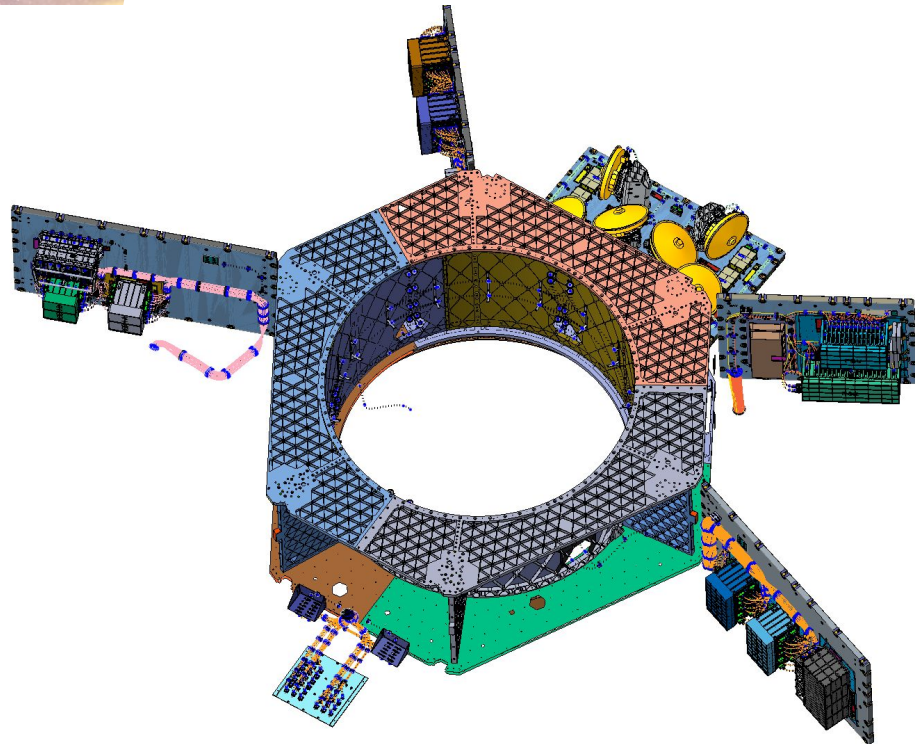

Deployable Aperture Cover Engineering Test

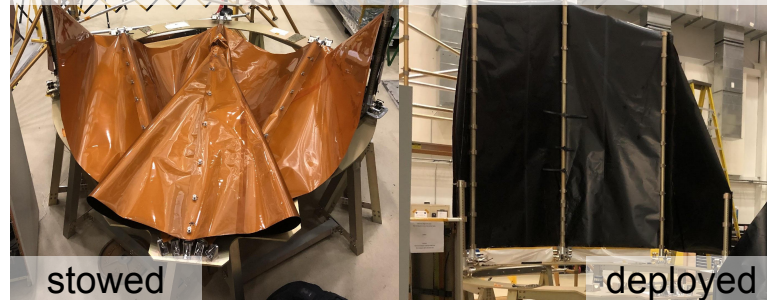

1.7m dual-band High Gain Antenna

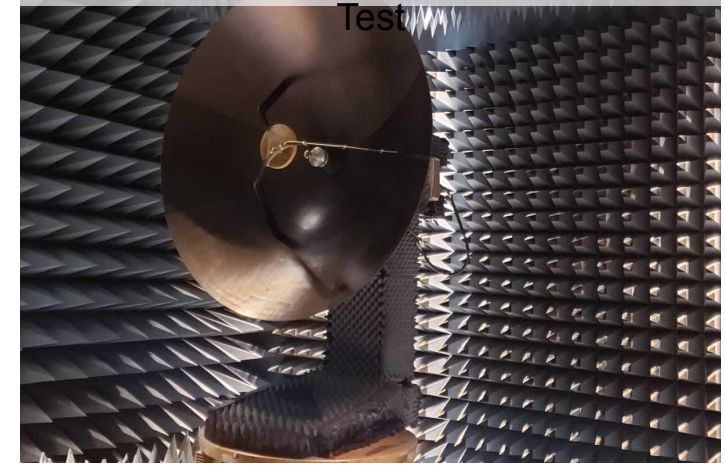

Solar Array / Sun Shield Engineering Test in Thermal/Vacuum Chamber

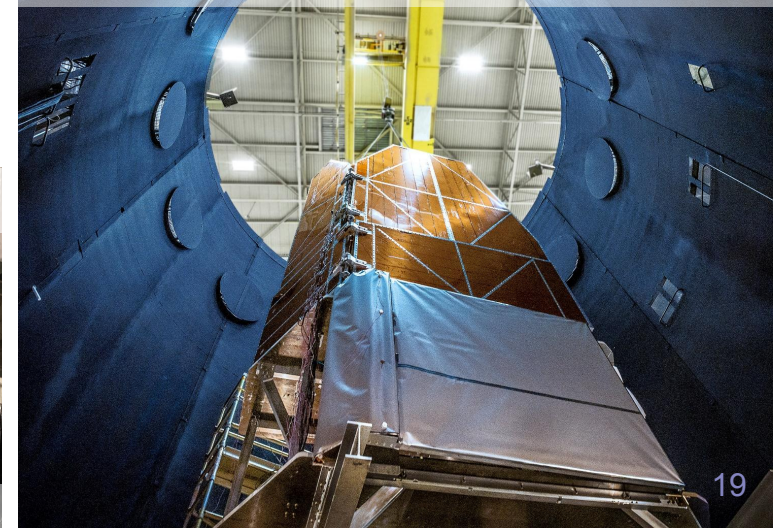

Coordination between *Roman* and *Rubin* Observatories



Roman Near IR Imaging

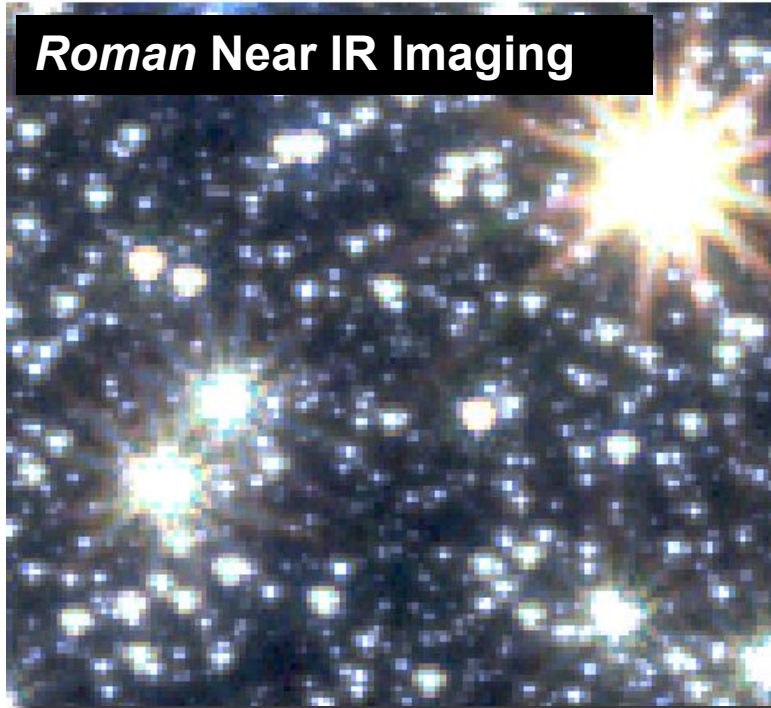

Rubin Visible Imaging

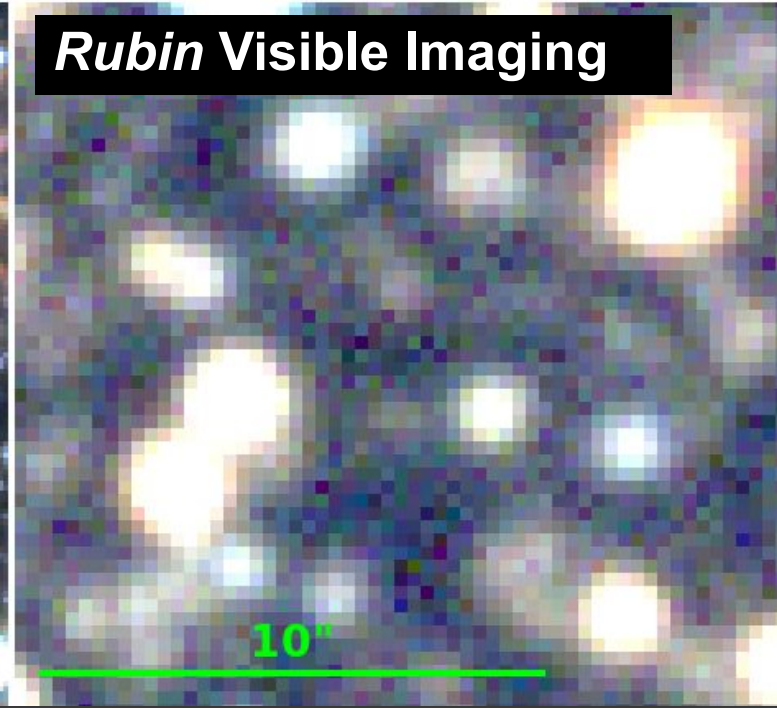

- NASA, NSF, DOE – through the Tri Agency Group - have charged Roman and Rubin project leads, plus US Euclid Lead, to investigate priorities for joint activities including data processing and simulations
- Much community input already via NASA/DOE RFI and anticipated via Astro2020 on leveraging synergies between *Roman* and *Rubin* (+*Euclid*)

Roman's Core Community Surveys

Core Community Surveys provide data needed to meet cosmology and exoplanet demographics science requirements

High-latitude Wide Area surveys

Enables weak lensing and redshift cosmology investigations of dark energy

High-latitude time-domain survey

Enables Type Ia supernova cosmology investigations of dark energy

Galactic Bulge time-domain survey

Enables exoplanet microlensing investigations

- However, the science scope and return will be *much broader*
- Core Community Surveys will be defined via an open process, with a goal of *maximizing the overall science return* while simultaneously meeting the cosmology and exoplanet science requirements
- All Core Community Surveys are owned by the community, not PIs

Other *Roman* Surveys?

- *Roman* interest groups have recommended considering early definition of additional survey(s) via broad community engagement.
- Have begun by announcing an open Request for Information to solicit science motivation for defining a *Roman* Astrophysics Survey now:
 - Consider surveys of up to 1 month scale, defined now and executed in ~first 2 years
 - Most time (≥ 14 months) still remains for allocation closer to launch, e.g. via proposals
 - Input accepted through Oct 22 at: https://roman.gsfc.nasa.gov/science/Early-definition_Astrophysics_Survey_Option.html
- If decision made for early definition of survey, it will be followed by a process to define the survey itself

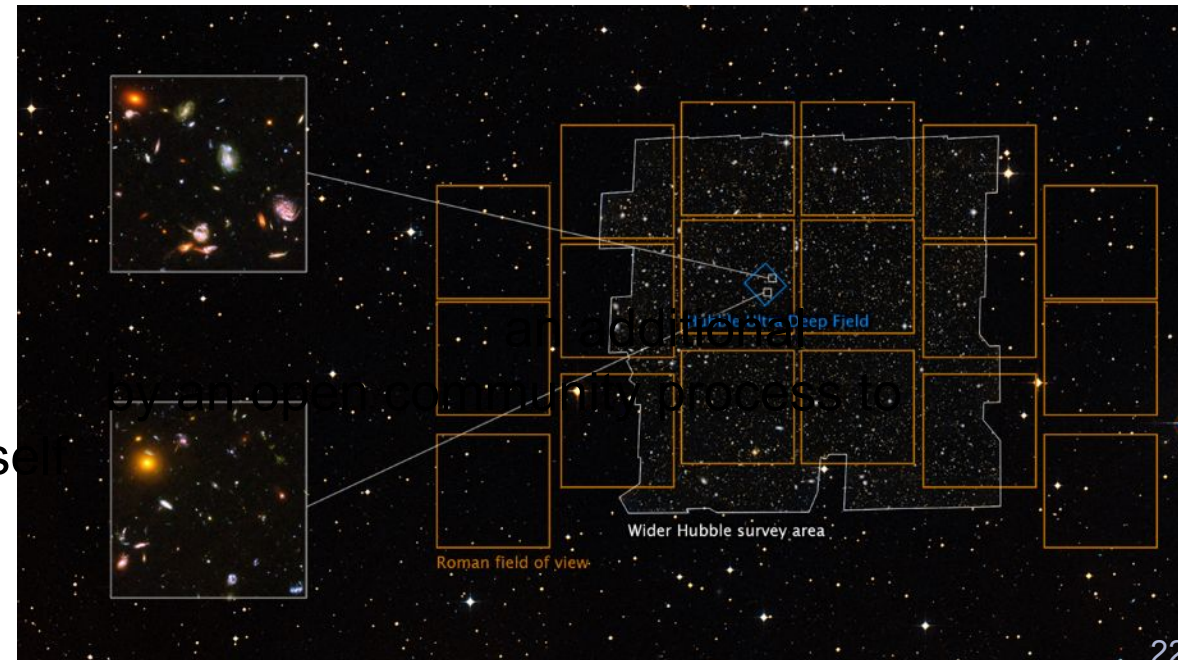

Future *Roman* Science Opportunities

- *Roman* opportunities announced in the ROSES call in February, proposal deadline targeted for early 2022
 - Includes opportunities for Coronagraph community participation, Wide Field Instrument preparatory science, and key project infrastructure teams.
 - Coronagraph Community Participation Program: Investigators to work with the coronagraph instrument team to plan and execute tech demo observations
 - Wide Field Instrument Preparatory Science: Investigators to work on science preparation activities related to mission performance verification and science operations preparation
 - Key Project Infrastructure Teams: Science teams to conduct scientific investigations using the data from the core community surveys
 - Accommodates stable long-term funding to support development of needed deliverables, creates flexible shorter-term opportunities to allow us to be more responsive to a changing science landscape, and allows a variety of different science community models – large open consortia, small PI-led teams, etc.

Coronagraph Instrument Information Sessions: Oct 26 & 28

https://roman.ipac.caltech.edu/mtgs/Roman_CGI_workshop.html

Formulation Science Investigation Teams Info Sessions: Nov 15-19

<https://roman.gsfc.nasa.gov/science/workshop112021/>



Astrophysics Budget Update





Continuing Resolution

Funds Government at FY21 levels through Dec 3, 2021 (9 weeks)

Also provides supplemental disaster relief funds including \$321.4 million for NASA to cover damage from Hurricane Zeta in 2020 and Hurricane Ida in 2021 at the Michoud Assembly Facility in New Orleans and Stennis Space Center in Mississippi

Astrophysics FY22 Budget Request

Requests \$1,575.5 M for NASA Astrophysics (including Webb) in FY 2022

What's Changed compared to one year ago (previous budget request)

- Funds continued development of the Nancy Grace Roman Space Telescope and estimated COVID impacts
- Plans for an Astrophysics Probe-class mission and other initiatives pending receipt of the Decadal Survey
- Four Astrophysics Pioneers conducting mission concept studies
- Enhanced facilities and open science initiatives within research program (e.g., laboratory equipment upgrades, extreme precision radial velocity program, formulation for integrating data archives with cloud computing)
- Science activation increases to support diversity and inclusion initiatives
- Astrophysics Strategic Mission Program management funding to support the management of Roman and upcoming probe-class missions in recognition of the enhanced management requirements of these missions

What's the Same compared to one year ago (previous budget request)

- Webb on track to launch in 2021
- Proposes termination of SOFIA due to its high cost and lower scientific productivity than other missions
- Hubble, Chandra, and other operating missions continue
- Supports development of IXPE, GUSTO, SPHEREx, and contributions to XRISM, Euclid, ARIEL
- Maintains Astrophysics Explorers cadence including both SMEX downselect and MIDEX AO in 2021
- CubeSat initiative and balloon campaigns within healthy research program

Astrophysics Budget – FY22 Request

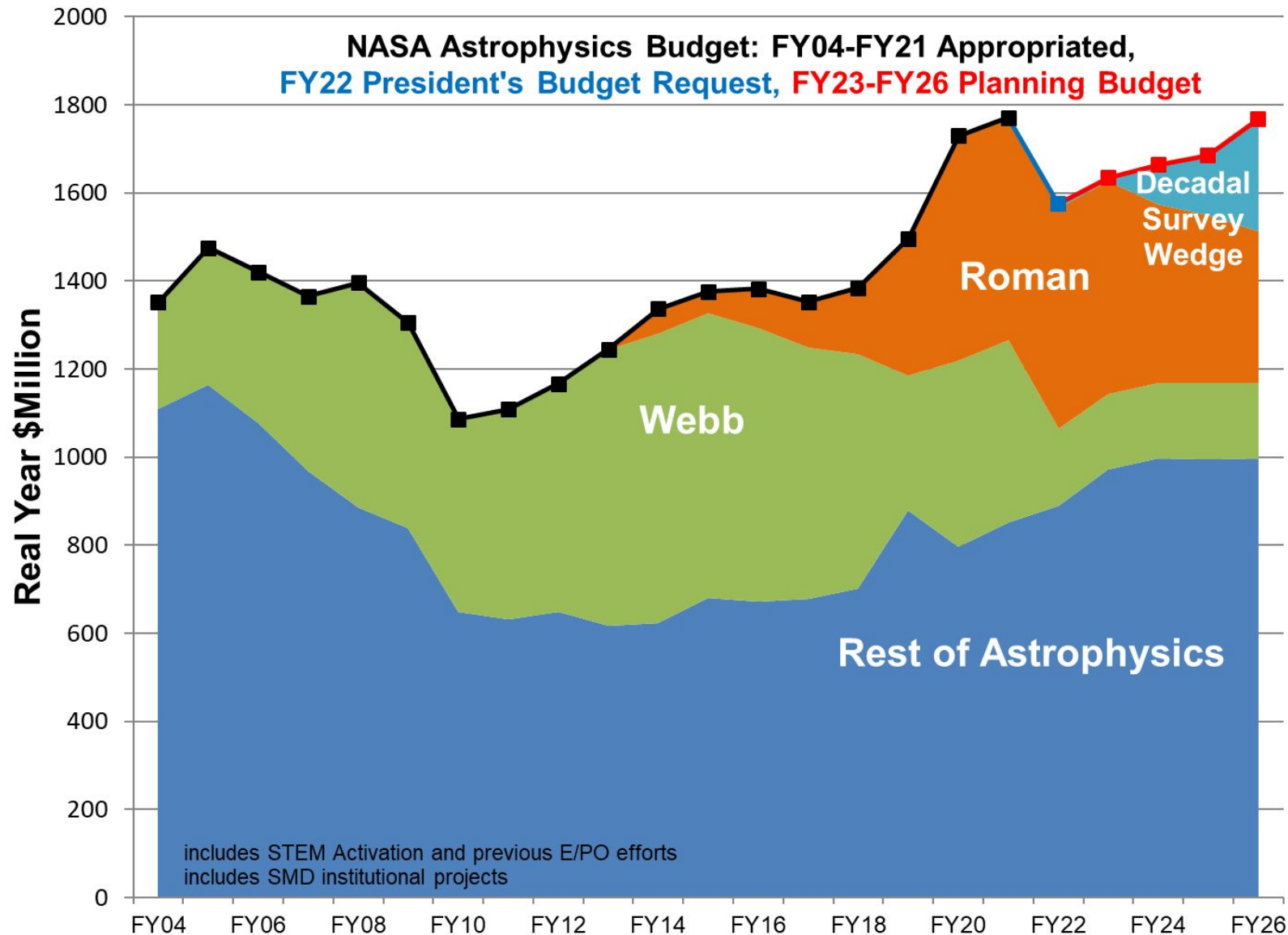

FY 2022 PRESIDENT'S BUDGET REQUEST SUMMARY

Budget Authority (\$ in millions)	Fiscal Year						
	Op Plan 2020	Enacted 2021	Request 2022	2023	2024	2025	2026
James Webb Space Telescope	423.0	414.7	175.4	172.5	172.0	172.0	172.0
Astrophysics	1,306.2	1,356.2	1,400.2	1,461.8	1,491.5	1,512.3	1,594.1
Astrophysics Research	231.2	249.3	285.5	328.0	339.0	344.1	345.3
Astrophysics Research and Analysis	86.6	91.1	107.4	94.9	95.2	95.2	95.2
Balloon Project	44.8	44.8	45.8	45.7	46.3	46.3	46.3
Science Activation	45.6	45.6	55.6	55.6	55.6	55.6	55.6
Other Missions and Data Analysis	54.3	67.8	76.7	131.8	141.9	147.0	148.2
Cosmic Origins	202.7	203.8	115.0	126.3	114.7	115.1	126.9
Hubble Space Telescope	90.8	93.3	98.3	98.3	98.3	98.3	98.3
Other Missions and Data Analysis	111.9	110.5	16.7	28.0	16.4	16.8	28.6
Physics of the Cosmos	132.8	146.4	156.0	160.0	169.1	159.8	167.6
Exoplanet Exploration	554.2	552.4	543.3	547.6	525.8	489.2	431.5
Nancy Roman Space Telescope	510.7	505.2	501.6	501.8	485.1	448.5	385.7
Other Missions and Data Analysis	43.5	47.2	41.7	45.8	40.7	40.7	45.8
Astrophysics Explorer	185.3	204.4	300.4	300.0	342.9	404.1	522.9
SPHEREx	66.6	68.5	89.9	96.7	75.0	24.0	6.0

Astrophysics FY22 Budget Mark-up

	Request \$M	House \$M	Senate \$M	Comments (all from House)
Webb	175.4	175.4		
Astrophysics	1,400.2	1,446.3		Add \$46.1M
SOFIA	0	85.2		The Committee rejects the Administration's request to terminate SOFIA
Roman	501.6	501.6		Shall include continued development of the coronagraph as a technology demonstration
Explorers	300.4	277.7		Cut \$22.7M
Research	285.5	279.1		Cut \$6.4M
Rest of Astrophysics	312.7	302.7		Cut \$10.0M (undistributed)



Selected NASA Astrophysics Updates



Personnel Update

Jeff Volosin, Deputy Director of Astrophysics, is moving to Goddard Space Flight Center at the end of October to be the Director of Earth Science Projects (Code 420)

Paul Hertz, Director of Astrophysics, will delay his transition from Astrophysics Director beyond the end of the year in order to ensure continuity for astrophysics leadership and the astrophysics program

Dan Evans is now the SMD Assistant Deputy Associate Administrator for Research

Kartik Sheth is now the Assistant Director for Research Infrastructures & Science Equity at the White House Office of Science and Technology Policy (OSTP)

New staff have joined during 2021: Program Scientists Roopesh Ojha, Sanaz Vahidinia, Heather Watson; Program Executive Rachele Cocks

Additional astrophysics program scientists (both civil servants and IPAs) will be selected / hired in the near future



Improving Inclusion at NASA



Inclusion – NASA is committed to a culture of diversity, inclusion, and equity, where all employees feel welcome, respected, and engaged. To achieve the greatest mission success, NASA embraces hiring, developing, and growing a diverse and inclusive workforce in a positive and safe work environment where individuals can be authentic. This value will enable NASA to attract the best talent, grow the capabilities of the entire workforce, and empower everyone to fully contribute.

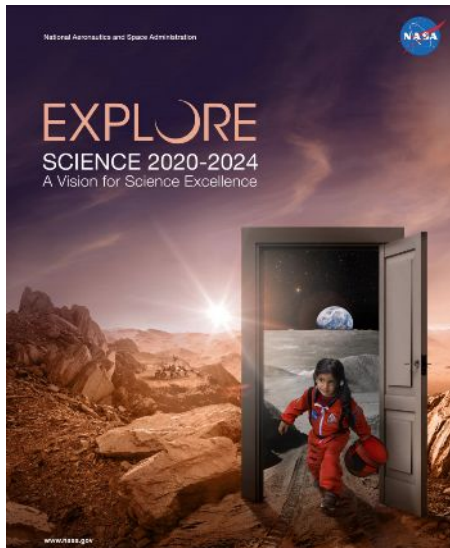

Strategy 4.1: Increase the diversity of thought and backgrounds represented across the entire SMD portfolio through a more inclusive and accessible environment.

ROSES: SMD's goals are to develop a workforce and scientific community that reflects the diversity of the country and to instill a culture of inclusion across its entire portfolio.

Building Excellent NASA Teams Requires Inclusion and Diversity



- At NASA, we recognize that excellence is only achieved with inclusive and diverse teams. We are creating a multi-pronged approach.
 - Standing up a long-term internal activity focused on sustained engagement, systemic, and lasting changes.
 - ❖ Modifying requirements for AOs to align with NASA's new core value of Inclusion; [draft modifications released for community comment](#).
 - ❖ [Piloting inclusion plans as an evaluation criterion for R&A programs](#).
 - ❖ Session at SACNAS on funding opportunities; NASA Town Hall and booth at NSBP
 - ❖ Requesting funding (starting in FY22) to establish Bridge Programs supporting MSIs and HBCUs.
 - ❖ Increasing Science Activation program to support diversity and inclusion initiatives.
 - Hosting [incubator workshops](#) and implementing actions from those workshops focused on short-term changes to how we are operating and how we grow our leaders.
 - [National Academies study of barriers to inclusion in mission leadership](#).
 - [Adopted a Code of Conduct to improve the inclusion and process of our panels and teams](#).
 - Astrophysics Division task force working to align division-level practices with the NASA core value and SMD science strategy. Examining the R&A process for better inclusion and diversity.
 - Proposal Processes: Recognizing we have influence through our calls for proposals and what we reward in our selections. [Piloting dual-anonymous peer review and seeking to expand that](#). Actively looking into how we can be a model for inclusivity.

Establishing New AO Requirements

NASA expects that inclusion, diversity, equity, and accessibility (IDEA) will be reflected in the composition of all Announcement of Opportunity (AO) proposal teams. NASA also expects that all AO mission projects will clearly define the principles by which team members can operate in an inclusive and equitable environment.

To meet NASA's expectations regarding the reflection of IDEA values in the composition of proposed mission teams, SMD plans to add language to future Announcements of Opportunity (AO) and amend the currently open Stand-Alone Mission of Opportunity Notice (SALMON-3). Proposers will be required to describe in their proposal how the processes used 1) to assemble the proposed team and 2) to execute the proposed project aligned with SMD's IDEA values, including the NASA Policy Statement on Diversity and Inclusion at <https://www.nasa.gov/offices/odeo/policy-and-publications>.

The full text of SMD's IDEA RFI, including the proposed new AO language and response instructions can be found at short URL: <https://go.nasa.gov/3xSsOP1>. RFI responses must be submitted via NSPIRES and are due on November 3, 2021.

Establishing New AO Requirements

Proposed new AO language can be found at short URL: <https://go.nasa.gov/3xSsOP1>.

NASA is committed to a culture of inclusion, diversity, equity, and accessibility (IDEA) where all employees feel welcome, valued, respected, and engaged. Inclusion is a NASA core value. To achieve mission success, NASA supports hiring, developing, and growing an inclusive and diverse workforce in a positive, safe, and equitable work environment where individuals can be authentic, have their voices heard, and be included as integral members of the team.

Building on this commitment, NASA also recognizes and supports the benefits of having inclusive and diverse scientific, engineering, and technology communities and fully expects that IDEA values will be reflected in the composition of all proposal teams, as well as peer review panels (science, engineering, and technology), science definition teams, and mission and instrument teams.

Requirement TBD1. Proposals shall include a description of the processes used to assemble the proposed team and how those processes align with NASA's IDEA values.

NASA expects that all mission projects will clearly define the principles by which team members can operate in an inclusive and equitable environment. These principles, as well as the processes in place for maintaining and improving the environment over the course of the mission, should be captured in a mission "Code of Conduct."

Requirement TBD2: Proposals shall describe the processes that will be employed to enable and monitor (i) the creation and maintenance of an inclusive and equitable environment throughout the project lifecycle, (ii) the maintenance of a diverse team, and (iii) the continued access to equitable opportunities for contributions from team members towards mission success.

Evaluation factor B-TBD will be evaluated by IDEA Subject Matter Experts (SMEs). The findings of the IDEA SMEs will be incorporated into the evaluation of the Scientific Implementation Merit and Feasibility of the Proposed Investigation (Form B). No separate score or grade will be provided for Factor B-TBD.

Factor B-TBD. Inclusion, diversity, equity, and accessibility (IDEA). The team's IDEA plans for forming a diverse team, plans for creating and maintaining an inclusive and equitable environment will be assessed. This factor includes the alignment of the proposal with NASA's core value of inclusion and the likelihood of successfully achieving the objectives of the "Code of Conduct" in service of mission success.

ATP Inclusion Criterion Pilot Program

All Astrophysics Theory Program (ATP) proposals should have included an inclusion plan. This section addresses:

- Plans for creating and sustaining a positive and inclusive working environment for those carrying out the proposed investigation, and
- Contributions the proposed investigation will make to the training and development of a diverse and inclusive scientific workforce

The inclusion plans are being evaluated for adequacy and completeness. In addition to the 20 science panels (which will evaluate all 182 proposals), there are 4 inclusion panels.

- Inclusion panels made up of astronomers active in DEI and DEI experts over a range of related fields

Feedback will be provided to the proposers as part of the panel review summaries.

- The feedback will not be folded into the adjectival ratings or selection recommendations in the current ROSES cycle, but may in future cycles
- Inclusion panels will not just be providing feedback on the plans, but will be helping us produce a lessons learned document that will record their findings on how to refine the solicitation and evaluation to best incorporate our inclusion goals as a selection criterion in future reviews
- NASA plans to invite comments from proposers regarding this pilot process after they receive their review comments

COVID Impacts: Status of SMD Programs

[UNCHANGED] NASA has been in a mandatory telework posture due to COVID-19 for over 18 months; NASA work has continued though there have been impacts

COVID Impacts on Missions:

- Projects continue to respond and replan due to changes due to COVID-caused issues; replans (including changes in cost and schedule estimates) continue to be reviewed and approved through the SMD Program Management Council process
- NASA Centers are ramping up onsite activities, including laboratory research and technology development, as 25% occupancy limit is lifted
- SMD COVID assumptions have been updated (but do not account for delta variant), which allows our missions to more effectively plan for operating over the next 12 months

COVID Impacts on R&A:

- No R&A solicitations or selections have been cancelled due to COVID; notifications and funding have continued at the pre-pandemic pace
- Virtual peer review panels will continue through December 2021, and likely beyond

How this affects the community:

- As vaccinations increase within the community, we will be able to interact more with our project teams, partners, and vendors by increasing on-site work and travel
- SMD is working toward multiple launches scheduled for the fall and winter of this year, including Webb, Lucy, Landsat-9, DART, IXPE, and GOES-T

COVID-19 Impacts – Missions

Many missions are expected to stay within their cost commitments (known as the ABC or Agency Baseline Commitment, which includes HQ held reserves above project budget)

- ABC is set at Confirmation Review

Some missions have experienced challenges that affect cost and schedule commitments

- In astrophysics, this includes Webb, Roman, and IXPE
- Missions that have been Confirmed since COVID began (e.g., SPHEREx), or will be Confirmed in the future (e.g., future Explorers) have assumed impacts from COVID included within their cost and schedule commitments

To date, challenges to Flagships (Webb, Roman) have been accommodated with no impact to Explorers or R&A

- Challenges to Explorers are accommodated within the Explorers Program

Mission impacts to commitments due to COVID (only missions with commitments)			
Webb	Exceeds schedule	XRISM	Does not exceed
IXPE	Exceeds cost and schedule*	SPHEREx	Included in commitment
GUSTO	Does not exceed	Roman	Exceeds cost and schedule*
Euclid	Does not exceed	* Replan has been completed and approved	

Supporting Work-Life Balance

- SMD recognizes the importance of balancing one's work with the requirements of one's family, friends and personal physical and mental health
- We have created a web page to inform SMD-funded researchers about NASA-provided wellness resources and leave options that may be available

<https://science.nasa.gov/researchers/work-life-balance>

- The web page discusses resources and flexibilities for
 - Recipients of NASA grants and cooperative agreements
 - NASA Civil Servant Scientists
 - NASA on-site contractors
 - NASA Postdoctoral Program Fellows
- The resources that one may access depend on one's relationship with NASA (above) and one's institution's policies
- One's first step, regardless of your relationship to NASA, should be to contact your institution's Office of Sponsored Programs, Human Resources or Human Capital Office to determine your employer's policies
 - NPP Fellows should contact their NPP Center Representative
- Please help us improve this webpage by sending suggestions, questions and feedback to sara@nasa.gov

R&A Research Funding

Update from
Stefan Immler
APAC Meeting Day 2

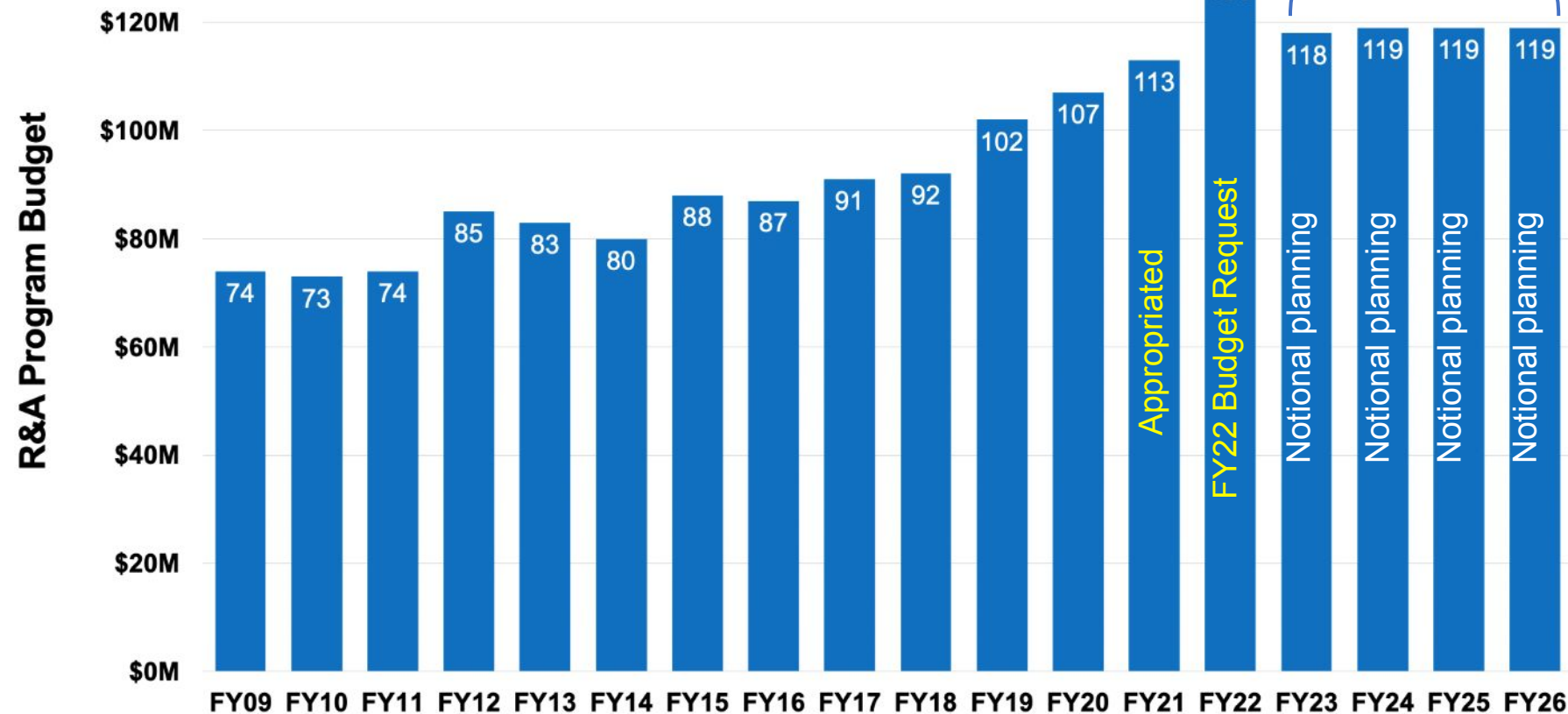

Since the last Decadal Survey:
+38% R&A funding growth

Notional Planning:
+60% over 17 years.

For the last 12 months (August 2020 – August 2021), the selection rates were 23% for R&A programs and 46% for smaller mission’s general observer (GO)/guest investigator (GI) programs*, with a total average selection rate of 35% for all our ROSES programs

Sustained growth in R&A research funding since the 2010 Decadal Survey

* Does not include Hubble, Chandra, SOFIA

Update from
Stefan Immler
APAC Meeting Day 2

Astrophysics Community Funding

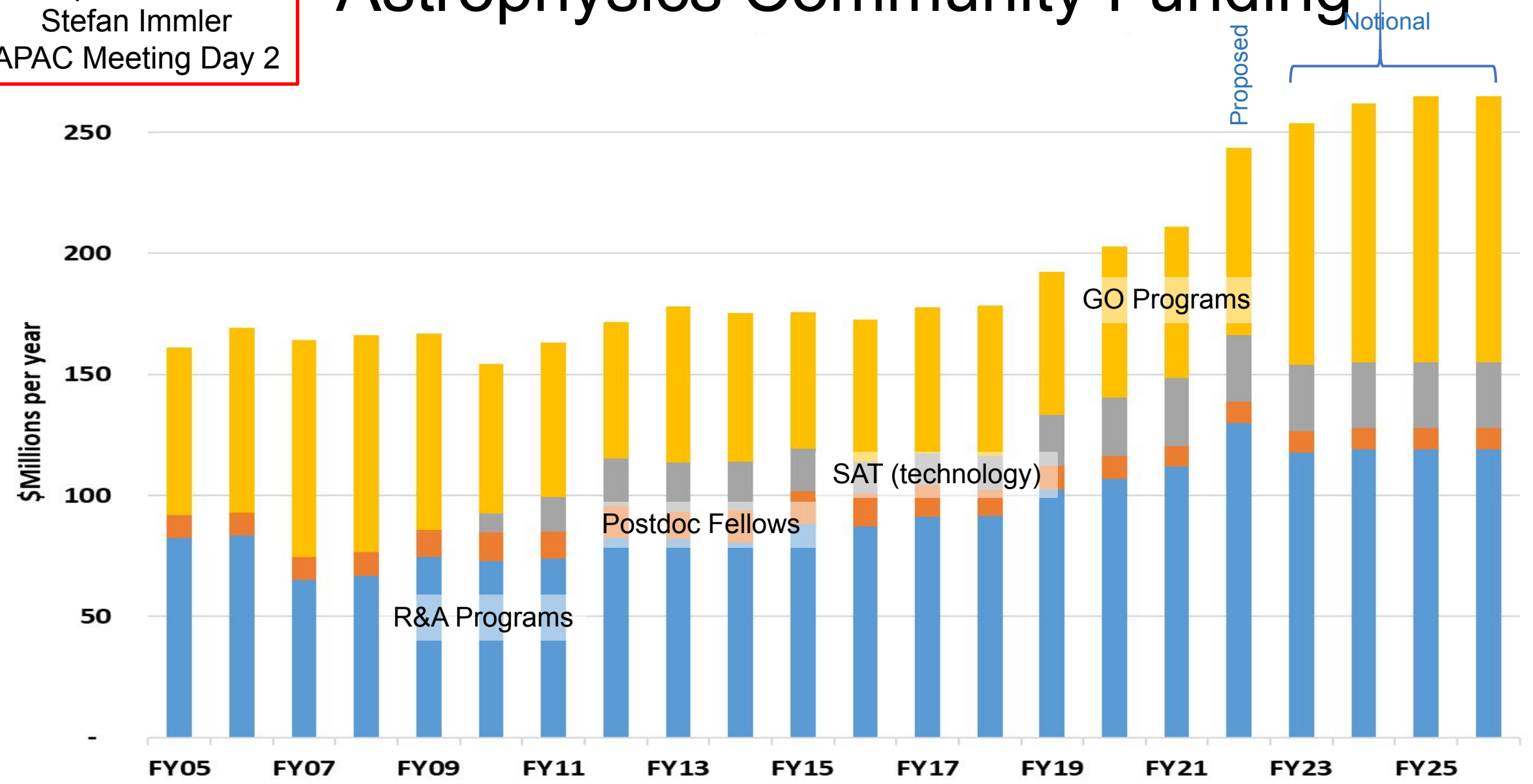

From Open Data to Open Science

Throughout NASA, we are looking to adopting open science principles to help advance *transparency, accessibility, reproducibility, and inclusion* in our scientific endeavors.

SMD has released [SPD-41: Scientific Information Policy](#) that consolidates existing guidance on how the results of its Federally funded scientific research and technology development are shared openly. An RFI will be released soon for public comment on implementation and enhancements. This policy covers:

- Information produced by NASA Science Missions
- Information produced by NASA research awards
- Open access to NASA-funded publications, data, and software

The **Open Source Science Initiative** looks to implement this strategy through cross-divisional activities that support open science. These include:

- Targeted investments in cloud computing, HPC, and Artificial Intelligence/Machine Learning
- ROSES calls supporting open-source tool development and the opening of legacy software
- Increasing access by making NASA data and publications more discoverable

Transform to Open Science is focused on capacity building to help accelerate scientific discovery through open science. This includes workshops and summer schools in 2023; the Year of Open Science.

Open Source Science for Data Processing and Archives Workshop

Thursday, Oct 14 @ 12:00-3:00 pm ET

<https://science.nasa.gov/researchers/science-data/open-source-science-workshop>

NASA Hubble Fellowship Program (NHFP) Review

The (NHFP) supports outstanding postdoctoral scientists pursuing independent research that contributes to NASA Astrophysics, using theory, observation, experimentation, or instrument development.

Merged the previously separate Einstein, Hubble, and Sagan Fellows programs in 2017

In the summer of 2021, we conducted the first programmatic review of its Fellowship Program since the original Hubble Fellowship Program was created over 30 years ago.

Review is intended to assist NASA increase the effectiveness of the program and bolster its excellence. It focused on two main areas:

1. Success of the NHFP under its current structure
2. Diversity, equity, and inclusion of the program

Panel convened comprised of a diverse group of astrophysicists and experts in diversity, equity, inclusion, and accessibility

- Co-chaired by Rita Sambruna, Deputy Director of the Astrophysics Division at GSFC, and Nicolle Zellner, Program Scientist in NASA HQ's Planetary Science Division
- The panel prepared a report of its findings, and the co-chairs developed a set of recommendations based on those findings.

Next Steps

- Co-chairs are debriefing Paul Hertz on Sep 29, 2021
- Co-chairs will report out at October APAC meeting
- Report and NASA's response will be publicly released
- A splinter session for January AAS has been proposed
 - panel co-chairs of the review process and key findings and recommendations
 - presentation by Astrophysics Division on plans to implement the recommendations and address the findings

Update from
Rita Sambruna &
Nicole Zellner
APAC Meeting Day 1



Astrophysics and the Moon

NASA Astrophysics has no strategic missions or strategic activities planned for the lunar surface, Gateway, or cis-lunar space

The Astrophysics Decadal Survey was charged to “Consider ongoing and planned activities and capabilities in other organizational units of NASA, including ... planned research platforms in Earth orbit and cis-lunar space.”

- NASA has sponsored a concept study of a radio observatory on the radio-quiet far side of the Moon, plus other related radio astronomy concepts

All science opportunities for lunar surface, Gateway, and cis-lunar space are open for proposed, competitive, PI-led, peer reviewed astrophysics activities

- This includes Payloads and Research Investigations on the Surface of the Moon (PRISM) (open to astrophysics on the lunar surface), Explorers including Missions of Opportunity (open to missions in cis-lunar space), and Pioneers (open to lunar surface and cis-lunar space missions)
- To date, three lunar landed experiments with relevance to astrophysics have been selected: a next generation laser retroreflector for general relativity tests and two technology demonstrations for measuring cosmic radio waves

Upcoming opportunities for discussing and proposing astrophysics on the Moon

- [PRISM](#) Step 1 deadline (Oct 22)
- [Lunar Surface Science Workshop](#): Landing Sites and CLPS Capabilities (Nov 18)
- [PRISM](#) Step 2 deadline (Dec 20)

Astrophysics Missions in Operations

<p>Hubble ^{4/90} NASA Strategic Mission</p>  <p>Hubble Space Telescope</p>	<p>Chandra ^{7/99} NASA Strategic Mission</p>  <p>Chandra X-ray Observatory</p>	<p>XMM-Newton ^{12/99} ESA-led Mission</p>  <p>X-ray Multi Mirror - Newton</p>	<p>Gehrels Swift ^{11/04} NASA MIDEX Mission</p>  <p>Neil Gehrels Swift Gamma-ray Burst Explorer</p>	<p>Fermi ^{6/08} NASA Strategic Mission</p>  <p>Fermi Gamma-ray Space Telescope</p>	<p>NuSTAR ^{6/12} NASA SMEX Mission</p>  <p>Nuclear Spectroscopic Telescope Array</p>
<p>SOFIA ^{5/14} NASA Strategic Mission</p>  <p>Stratospheric Observatory for Infrared Astronomy</p>	<p>ISS-NICER ^{6/17} NASA Explorers Miss. of Oppty</p>  <p>Neutron Star Interior Composition Explorer</p>	<p>TESS ^{4/18} NASA MIDEX Mission</p>  <p>Transiting Exoplanet Survey Satellite</p>	<p>Balloon Program Four Campaigns per Year</p>  <p>Managed by the Astrophysics Division</p>	<p>Sounding Rockets Worldwide Campaigns</p>  <p>Managed by the Heliophysics Division</p>	<p>Data Archives HEASARC, IPAC, MAST, etc.</p>  <p>Managed by the Astrophysics Division</p>

Next Senior Review is in 2022

SOFIA Deploys to French Polynesia



SOFIA lands at Fa'a'a International Airport in French Polynesia during deployment. Credit: Robert Simon



Credit: NASA/J. Spooner

- SOFIA arrived in French Polynesia for its Southern Deployment on July 19, 2021.
- During the four week campaign the SOFIA team completed 13 successful flights where they observed:
 - the concentration of hydride molecules in our Milky Way galaxy and their relation to cosmic rays
 - star formation, looking at how stellar winds might be triggering or quenching star formation in their surroundings.
 - observations of atomic oxygen in the Earth's atmosphere.
- The team returned approximately one month ahead of schedule due to updated COVID-19 precautions.
 - The decision to return SOFIA early to its base of operations aligned with the Centers for Disease Control and Prevention travel guidelines and SOFIA mission partner health and safety protocols.

Initial Anomaly

Hubble Anomaly Timeline



Tiger Team Formation

Troubleshooting

Operations Acceptance Test

Most Probable Root Cause Identified

Return to Science

Root Cause Analysis

Side Switch Planning

Side Switch

6.13.2021

07.08.2021

07.14.2021

07.20.2021

Anomaly Timeline Details

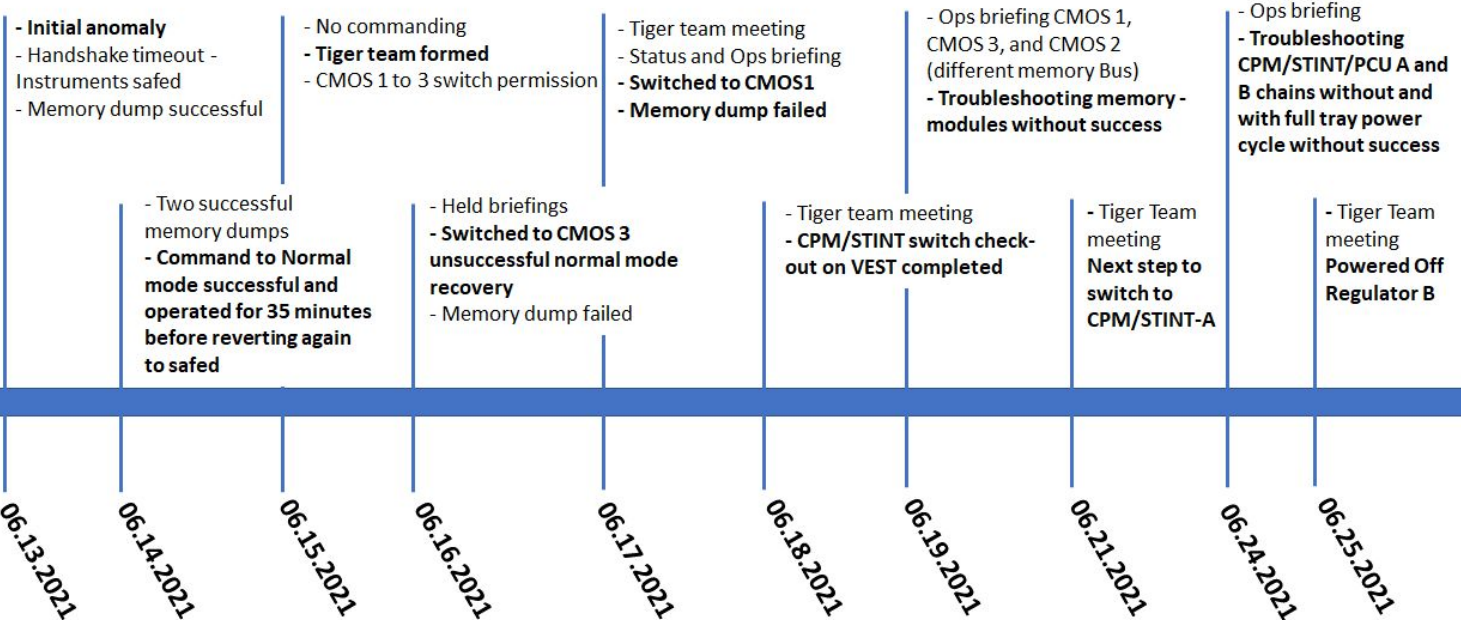

“Hubble Returns to Full Science Observations and Releases New Images”

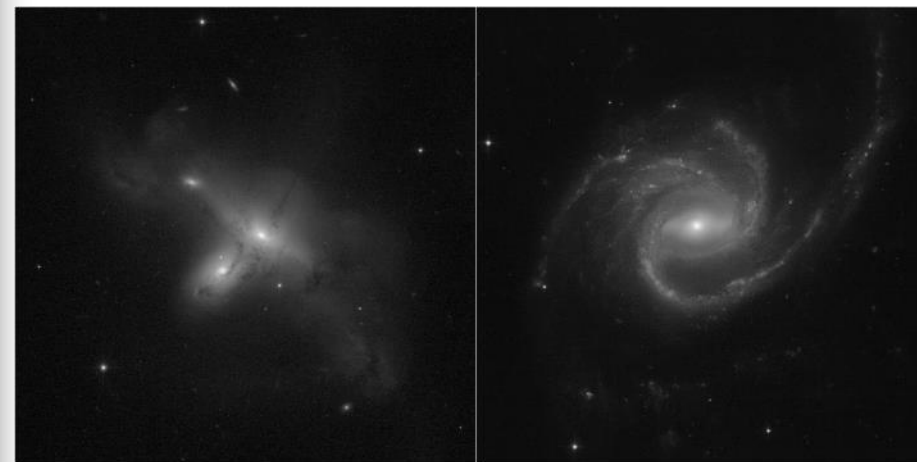

Astrophysics 2022 Senior Review

Triennial peer-review mandated by Congress of operating missions (last one was 2019) to assist NASA in planning its strategy for extended missions

SMD Missions to be reviewed by Astrophysics Division

Hubble, Chandra, SOFIA (separate panels)

Fermi, New Horizons, NICER, NuSTAR, Swift, TESS, XMM-Newton (one panel)

NASA will use the review information to:

Prioritize the operating missions and projects;

Define an implementation approach to achieve astrophysics strategic objectives;

Provide programmatic direction to the missions and projects concerned for FY23, FY24 and FY25; and issue initial funding guidelines for FY26 and FY27 (to be revisited in the 2025 Senior Review)

Notional Schedule

Call for proposals: 1-Oct-2021

Proposal due date: 1-Feb-2022

Site visits for large missions: March 2022

Panel reviews merged and delivered to APAC: April 2022

Special meeting of the APAC for recommendations to NASA: May 2022

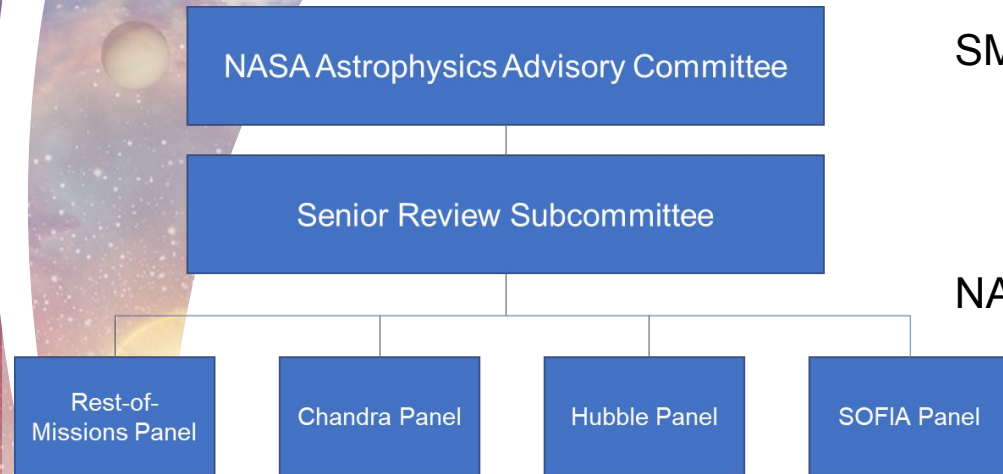

Astrophysics Missions in Development

Webb 2021
NASA Mission



James Webb
Space Telescope

IXPE 2021
NASA Mission



Imaging X-ray
Polarimetry Explorer

GUSTO 2022
NASA Mission

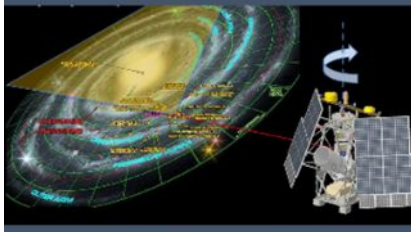

Galactic/ Extragalactic ULDB
Spectroscopic Terahertz Observatory

Euclid 2022
ESA-led Mission



NASA is supplying the NISP
Sensor Chip System (SCS)

XRISM 2023
JAXA-led Mission



NASA is supplying the SXS
Detectors, ADRs, and SXTs

SPHEREx 2025
NASA Mission



Spectro-Photometer for the History of
the Universe, Epoch of Reionization,
and Ices Explorer

SMEX ~2025
NASA Mission



COSI or ESCAPE

Mission of Opportunity ~2025
NASA Mission



Dorado or LEAP

Roman 2027
NASA Mission



Nancy Grace Roman
Space Telescope

ARIEL 2029
ESA-led Mission



NASA is supplying the CASE
fine guidance instrument

Launch dates are current project working dates; Agency Baseline Commitment launch date could be later; all impacts of COVID-19 not yet known

Astrophysics Mission Classes

DECADAL SURVEY	EXPLORER AO	SALMON AO	ROSES	
>\$1B	\$450M	\$80M	\$20M	\$0
<p>>\$1B</p> <p>LARGE CLASS</p> <p>Great Observatory or Flagship</p>	<p>~450M</p> <p>SMALL CLASS</p> <p>Medium Explorer (MIDEX) PICC \$290M*</p>	<p>\$80M</p> <p>SMALL CLASS</p> <p>Standard Mission of Opportunity **</p>	<p>\$20M</p> <p>SMALL CLASS</p> <p>Pioneers SmallSat</p>	<p>\$20M</p> <p>SUBORBITAL</p> <p>Pioneers Balloon</p>
<p>~\$1B</p> <p>MEDIUM CLASS</p> <p>Probe</p>	<p>~225M</p> <p>SMALL CLASS</p> <p>Small Explorer (SMEX) PICC \$145M*</p>	<p>\$40M</p> <p>SMALL CLASS</p> <p>SmallSat Mission of Opportunity **</p>	<p>\$5M</p> <p>SMALL CLASS</p> <p>APRA CubeSat</p>	<p>\$10M</p> <p>SUBORBITAL</p> <p>APRA Balloon</p>
				<p>\$5M</p> <p>SUBORBITAL</p> <p>APRA Sounding Rocket</p>

Astrophysics Pioneers

- A new class of small missions solicited annually in ROSES. Includes SmallSats, CubeSats >6U, major balloon payloads, modest ISS attached payloads, and lunar surface CLPS payloads; \$20M maximum PI cost cap
- Fills in the gap between existing ROSES investigations (<\$10M for APRA) and existing Explorers MO investigations (~\$35M for SmallSats)
- Light touch NASA management; relieves burden of writing full Explorers MO proposal (ROSES 2021 Amendment D.15)

PUEO: A Long-duration Balloon-borne Instrument for Particle Astrophysics at the Highest Energies, PI Abigail Vieregg, U Ch

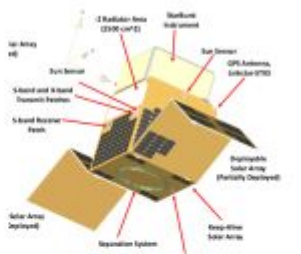
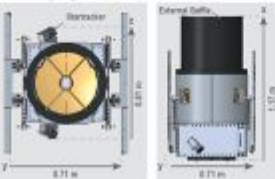

Figure 10: A rendering of the PUEO payload, including a design for the low-frequency drop-down instrument.

StarBurst: Gamma-ray ASM, Simultaneous detection of NS/NS mergers with LIGO, PI Daniel Kocevski, MSFC



Pandora: Multiwavelength Characterization of Exoplanets and their Host Stars, PI Elisa Quintana, GSFC



Aspera: IGM Inflow/outflow from galaxies via OVI 10²K emission line imaging. PI Carlos Vargas, U of A

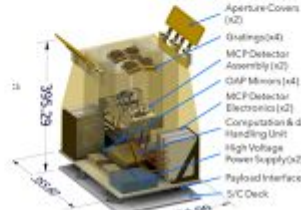

- ROSES-2021 due date NET March 2022

- First four selections made January 2020
- Teams working on Concept Study Reports; must pass NASA cost assessment of <\$20M, rolling decisions complete by ~Jan 2022

Astrophysics Explorers Program



MIDEX 2021
 Comm Ann release Sep 29, 2020
 Draft AO release Jan 6, 2021
 Comments due Feb 25, 2021
 Final AO released Aug 24, 2021
 NOIs due Oct 14, 2021
 Proposals due Dec 9, 2021

SMEX 2019 Downselect
 Phase A Studies due Mar 4, 2021
 Downselect decision Fall 2021

4 AOs per decade



MIDEX 2011



SMEX 2014



MIDEX 2016



SMEX 2019

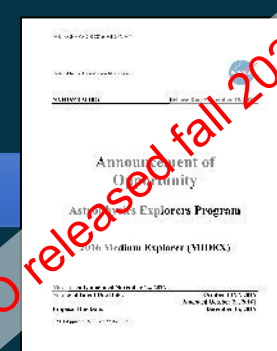

MIDEX 2021

Small and Mid-Size Missions



TESS



IXPE



SPHEREx



ESCAPE COSI



Directed 2013
Euclid

Missions of Opportunity



NICER



GUSTO



ARIEL



Dorado LEAP



Directed 2017
KRISM

Euclid

ESA and NASA partnership

- Euclid will study the nature of Dark Energy, Dark Matter and General Theory of Relativity

NASA delivered Sensor Chip System includes 16 Flight and 4 Spare Sensor Chip Systems for the Near Infrared Spectrometer Photometer instrument

Euclid NASA Science Center at IPAC and over 70 US Science Team members

STATUS:

- Payload thermal vac is completed
- Near Infrared Spectrometer and Photometer instrument data communication issue resolved
- Payload will be shipped to Italy around October/November for spacecraft integration
- IPAC science ground segment software deliveries on track
- Launch in late 2022

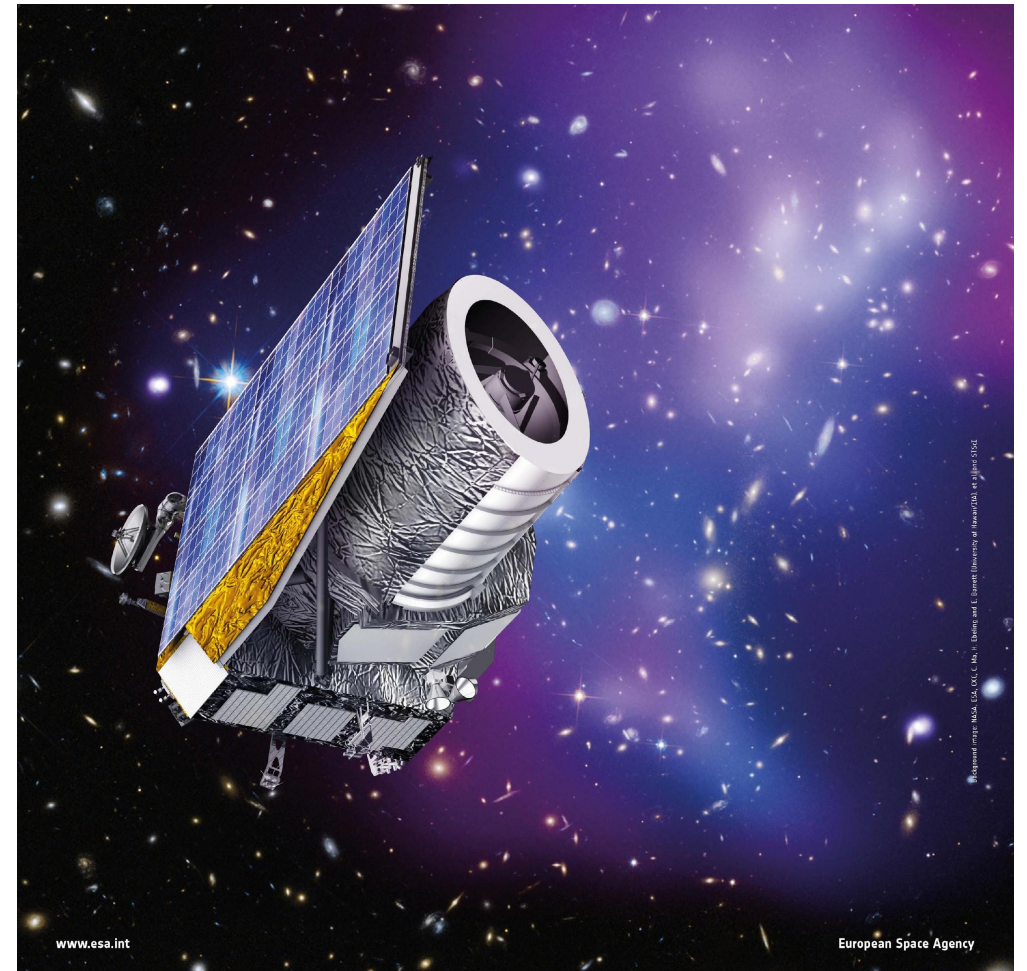

XRISM

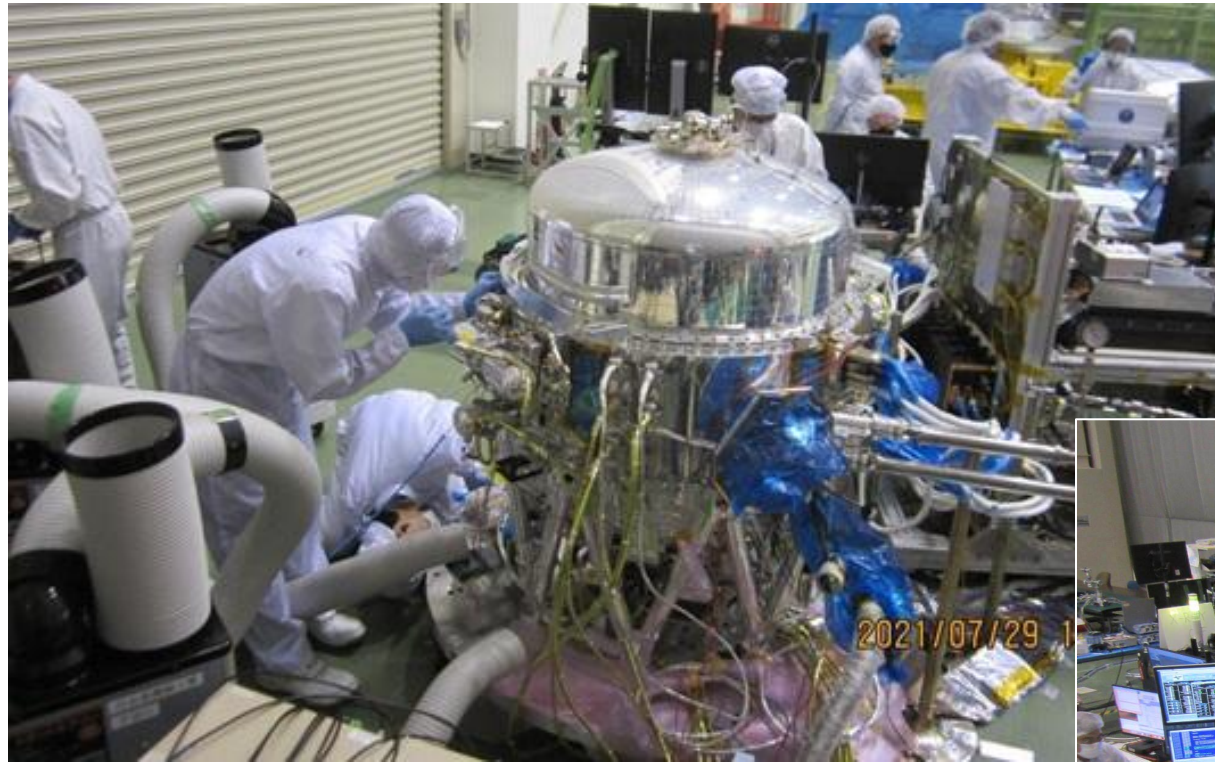

After 1.5 years of tough travel to Japan during pandemic, the NASA and JAXA teams have verified that a helium leak in the JAXA dewar has been fixed.

After completion of the dewar cool-down and checkout of the flight hardware the dewar was reconfigured for the start of thermal balance tests at the end of July.

NASA and JAXA teams working while in quarantine at the Tsukuba Space Facility (TKSC)



Xray Imaging and Spectroscopy Mission



- After 1.5 years of tough travel to Japan during pandemic, the NASA and JAXA teams have verified that a helium leak in the JAXA dewar has been fixed.
- Integration and Test continues with in-person and remote NASA support, launch early 2023
- X-ray Mirror Assemblies complete and under calibration at GSFC – delivery to Japan in Jan 2022
- XRISM Guest Scientist program for broader US participation in Performance Verification phase solicited through ROSES 21 – amendment to come early 2022
- PV phase targets:
<https://heasarc.gsfc.nasa.gov/docs/xrism/timelines/pytargets.html>
- Special XRISM session at winter AAS 2022 if in person, otherwise HEAD 2022.

ULTRASAT

- ULTRASAT: a wide-field (>200 sq deg) UV survey & transient detection mission by the Israel Space Agency & Weizmann Institute of Science
 - NASA providing commercial launch ~late 2024/early 2025 for a 3-yr prime mission in geosynchronous orbit
 - Data public at IPAC following 12-mo exclusive data use period
- Science: Main focus on gravitational wave sources, supernovae, variable and flare stars, and time domain astronomy. Public alerts within 20-min of trigger.
- Status
 - Israel Space Agency CDR in early 2022
 - NASA-ISA MOU awaiting signature
 - US Participating Scientist program to be amended to ROSES-21 in early 2022
 - 2nd Science meeting Oct 4 – 5, 2021
<http://www.weizmann.ac.il/ultrasat/science-workshops/2nd-ultra-...-science-workshop-and-collaboration-day-october-4-6-2021>

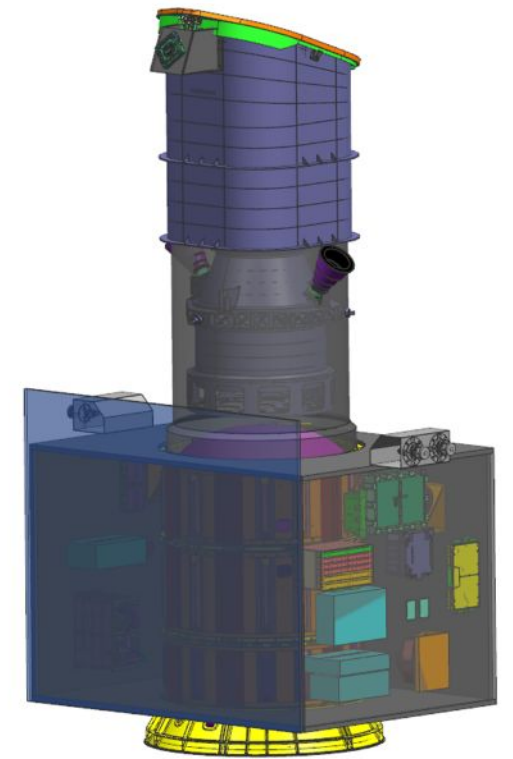

ULTRASAT Concept
Source: Israel Aerospace Industries (IAI)

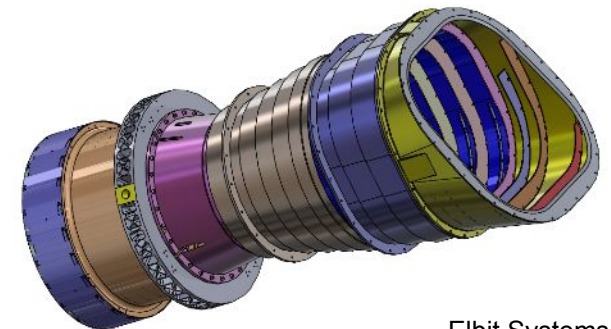

Elbit Systems

SPHEREx

Spectro-Photometer for the History of the Universe, Epoch of Re-ionization, and Ices Explorer Mission

NASA's first all-sky near-infrared (0.75 microns – 5 microns) spectral survey. Science goals include:

- Probe the origin of the Universe by improving constraints on inflationary non-Gaussianity through a large-volume galaxy redshift survey.
- Investigate the origin of water and biogenic molecules from interstellar ices in the early phases of planetary system formation.
- Chart the origin and history of galaxy formation, from light produced by the first galaxies that ended the cosmic dark ages to the present day.
- Provide a rich public spectral archive for diverse investigations ranging from X-ray astronomy to exoplanet characterization.

Critical Design Review (CDR) planned for January 18-21, 2022

Systems Integration Review (SIR) planned for June 2023

Current Agency launch readiness date is April 2025

Status

- Prototype telescope mirror in cryogenic testing. Fabrication of flight telescope mirror to start late this CY.
- Development of flight detectors is ongoing at Teledyne.
- V-Grooves payload thermal subsystem is in detailed design at JPL.
- Photon shield payload thermal subsystem is in vendor procurement process.

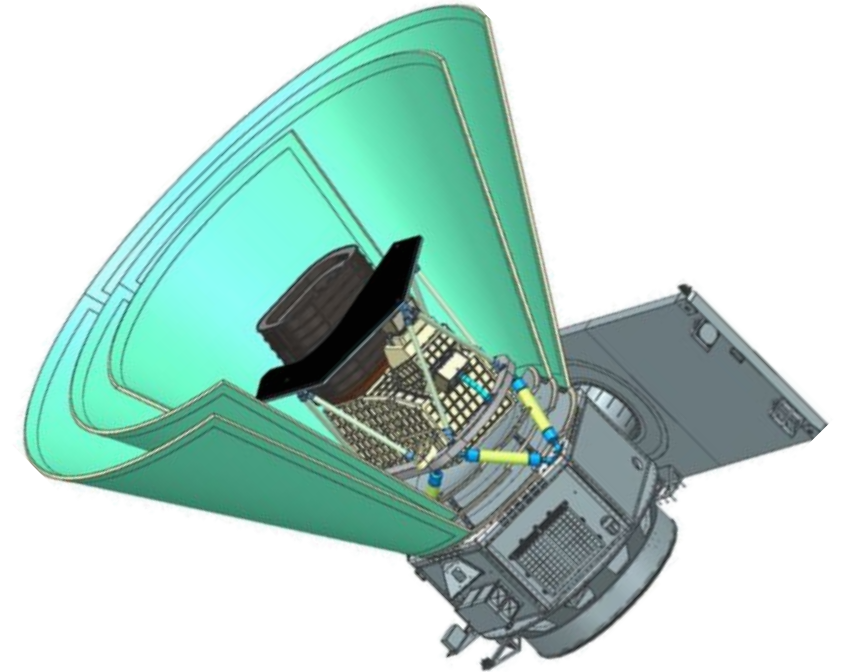

ARIEL

Atmospheric Remote-sensing Infrared Exoplanet Large survey

ESA and NASA partnership

- Observe ~1000 planets
- Survey and characterize exoplanet atmospheres

NASA contribution (CASE) includes detectors and cold front-end electronics, packaging, thermal management, and cryoflex cables for ARIEL Fine Guidance System

Provides US participation in science team, mission survey design, and scientific discoveries

STATUS:

- MOU draft is complete and under review
- Spring 2022 – NASA CASE PDR
- Summer 2022 – NASA CASE KDP-C
- Fall 2023 – NASA CASE CDR
- Hardware deliveries late 2024 to 2025
- Launch ~2029

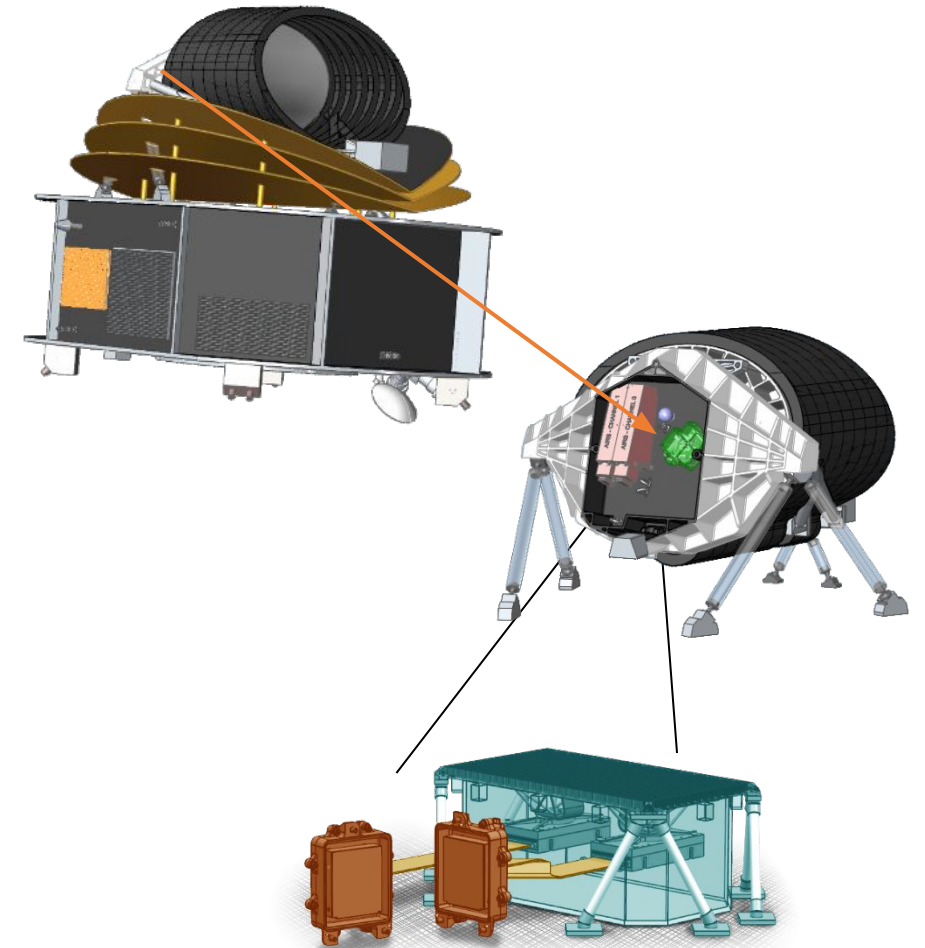

CASE

Contribution to ARIEL Spectroscopy of Exoplanets

ATHENA

Advanced Telescope for High ENergy Astrophysics

ESA and NASA partnership

ATHENA will map hot gas structures and determining their physical properties, search for supermassive black holes in the Hot and Energetic Universe

NASA contributions:

- X-IFU Focal Plane Array (GSFC, NIST-Boulder, LLNL, Stanford, UMBC, UC-Boulder)
- Use of NASA Testing Facilities MSFC XRCF facility for mirror calibration
- Vibration Isolation System
- WFI VERITAS ASIC Design for detector readout and WFI Background Analysis Model
- Science Grant Program for US Co-Is and Guest Observers

STATUS:

- NASA transitioned from ATHENA study phase to ATHENA project on September 30, 2021. GSFC is the implementing Center
- August 2022 – KDP-A/B
- February 2023 - ESA Mission Adoption
- September 2023 ~ KDP-C
- Launch ~ 2034

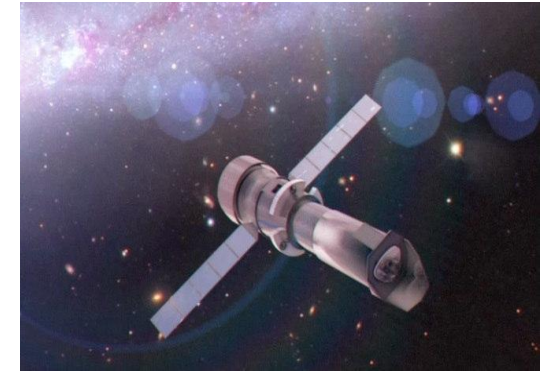

x 120

Vibration Isolation System

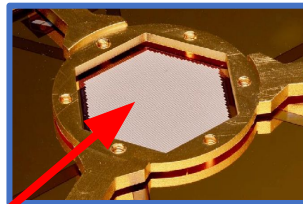

Focal Plane Array

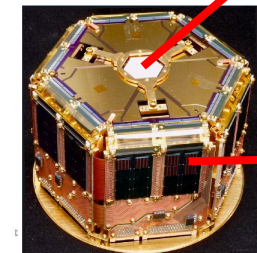

Sensor Assembly

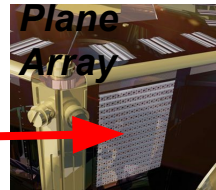

Readout

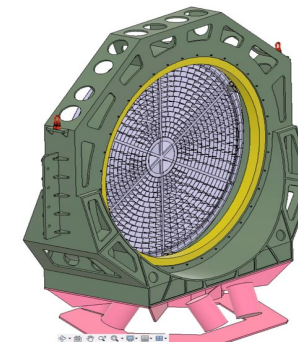

XRCF Mirror Assembly

X-IFU Focal Plane Array

Astrophysics

Decadal Survey Missions



1972
Decadal Survey
Hubble

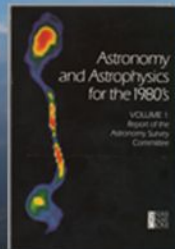
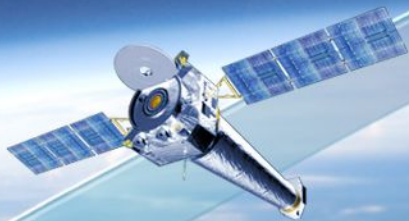

1982
Decadal Survey
Chandra

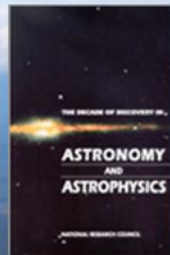

1991
Decadal Survey
Spitzer



2001
Decadal Survey
Webb

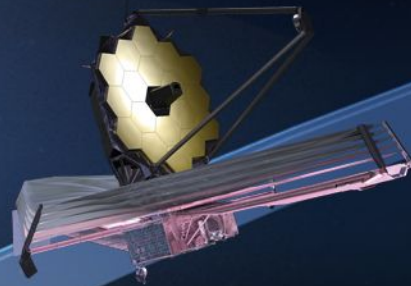

2010
Decadal Survey
Roman

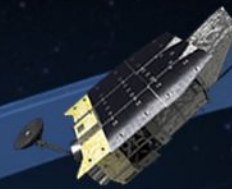

2021
Decadal Survey



Astrophysics

Decadal Survey Missions



1972
Decadal Survey
Hubble

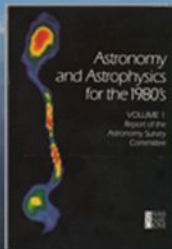

1982
Decadal Survey
Chandra

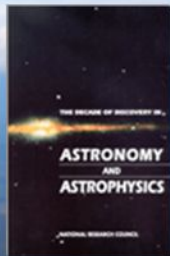

1991
Decadal Survey
Spitzer



2001
Decadal Survey
Webb



2010
Decadal Survey
Roman



2021
Decadal Survey

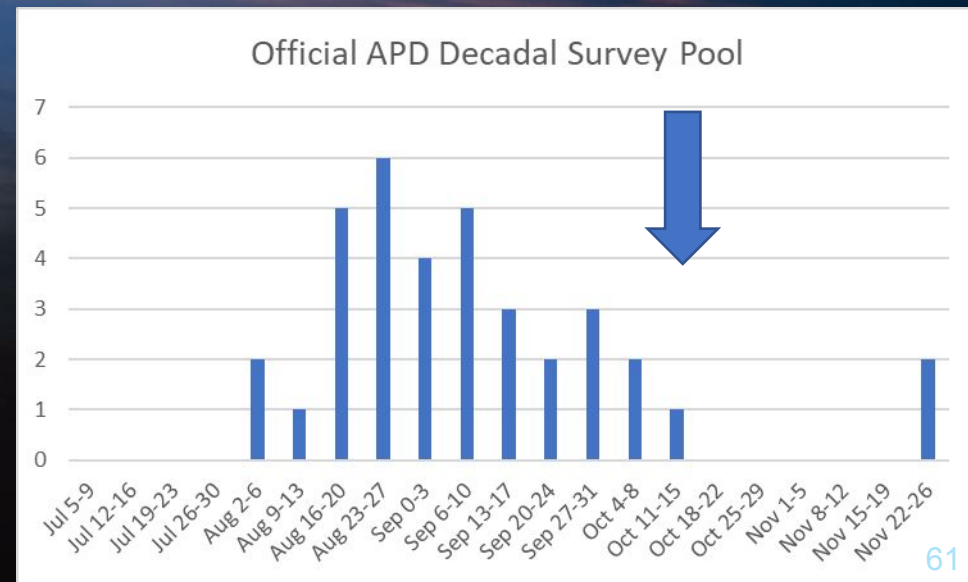

Preparing for the Decadal Survey: Technology Development and Risk Reduction Activities

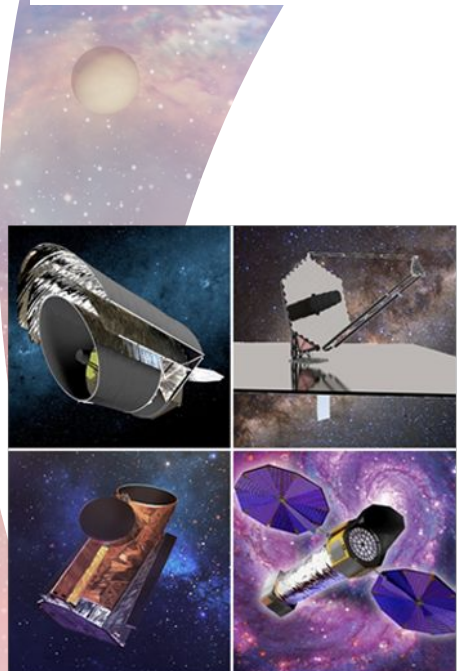

Large Mission Concepts

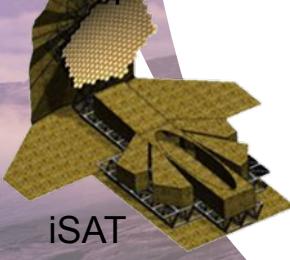

iSAT Concept

Probe Concepts



Completed
Large Mission Concept Studies / Probe Mission Concept Studies / In-Space Assembly of Telescopes (iSAT) Study / Large Mission Management Study / STMD Technology Collaborations
Ongoing
Segmented Mirror Technology Program / Binary Star Coronagraph Technology / Deformable Mirrors / Starshade Technology / Extreme Precision Radial Velocity Research and Technology / Detectors (at all wavelengths) / X-ray Mirrors / Cryocoolers
Testbeds (Coronagraph, Ultrastable, X-ray & Cryogenic)
PI-led Strategic Astrophysics Technology (SAT) Advancements

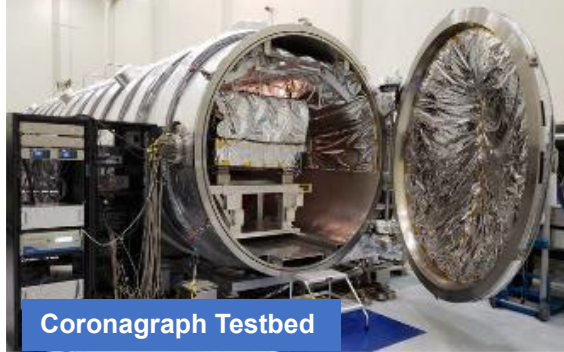

Coronagraph Testbed

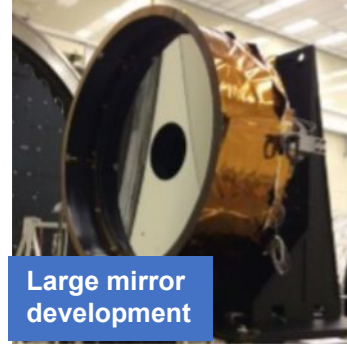

Large mirror development

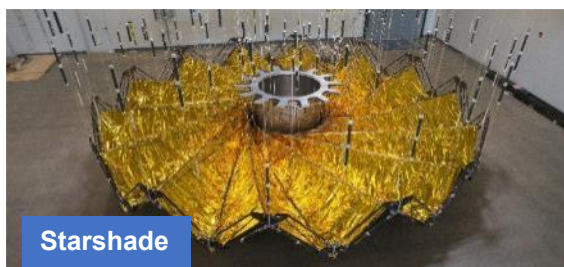

Starshade



X-ray mirror development

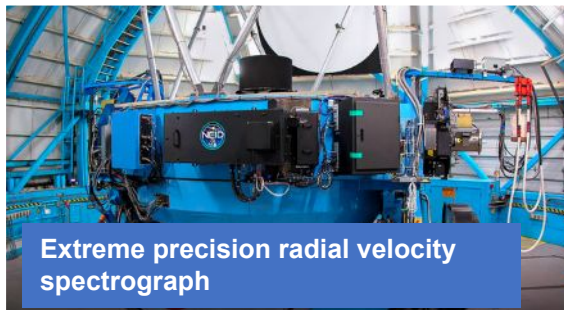

Extreme precision radial velocity spectrograph

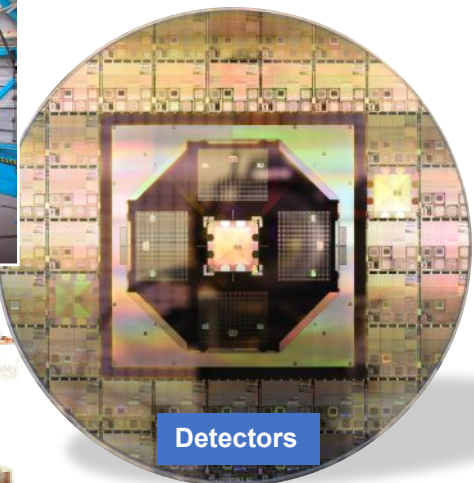

Detectors



Deformable Mirror

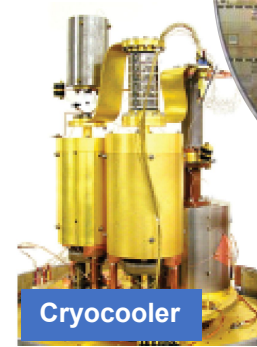

Cryocooler

For more information on technology development activities, see the Astrophysics Technology Development Database (<http://www.astrostrategictech.us/>)

NASA Planning for Astro2020



- NASA is planning for implementing the Decadal Survey
 - Reducing risks of large missions via technology development and through studying lessons learned from prior large missions
 - Developing options for recommendations in R&A, archives, suborbital, Explorers, Probes
 - Developing options for flagship risk reduction activities; stay focused on Webb and Roman
 - Holding a wedge in out year planning budget for new initiatives
- NASA plans to provide an initial response to the community within a few months of receiving the Astro2020 Decadal Survey Report
 - Announce implementation of recommendations that can be implemented immediately (within budget, within authority)
 - Announce plans for developing responses to long-term recommendations
 - Communicate and engage with the community throughout

Astrophysics is Looking Up

Webb is launching, Roman completed CDR

Explorers are being competed and selected regularly

Smaller missions (e.g., CubeSats, Pioneers) are being competed and selected annually

International partnerships are strong

R&A budgets are up, suborbital capabilities are expanding

Technology investments are being made for future missions

NASA is prioritizing an inclusive and diverse astrophysics community, and is initiating changes to address systemic failures that limit accessibility

The FY22 budget request supports all this PLUS contains a funding wedge for a Probe mission and other Decadal Survey priorities





BACKUP



Astrophysics Budget – FY21 Op Plan

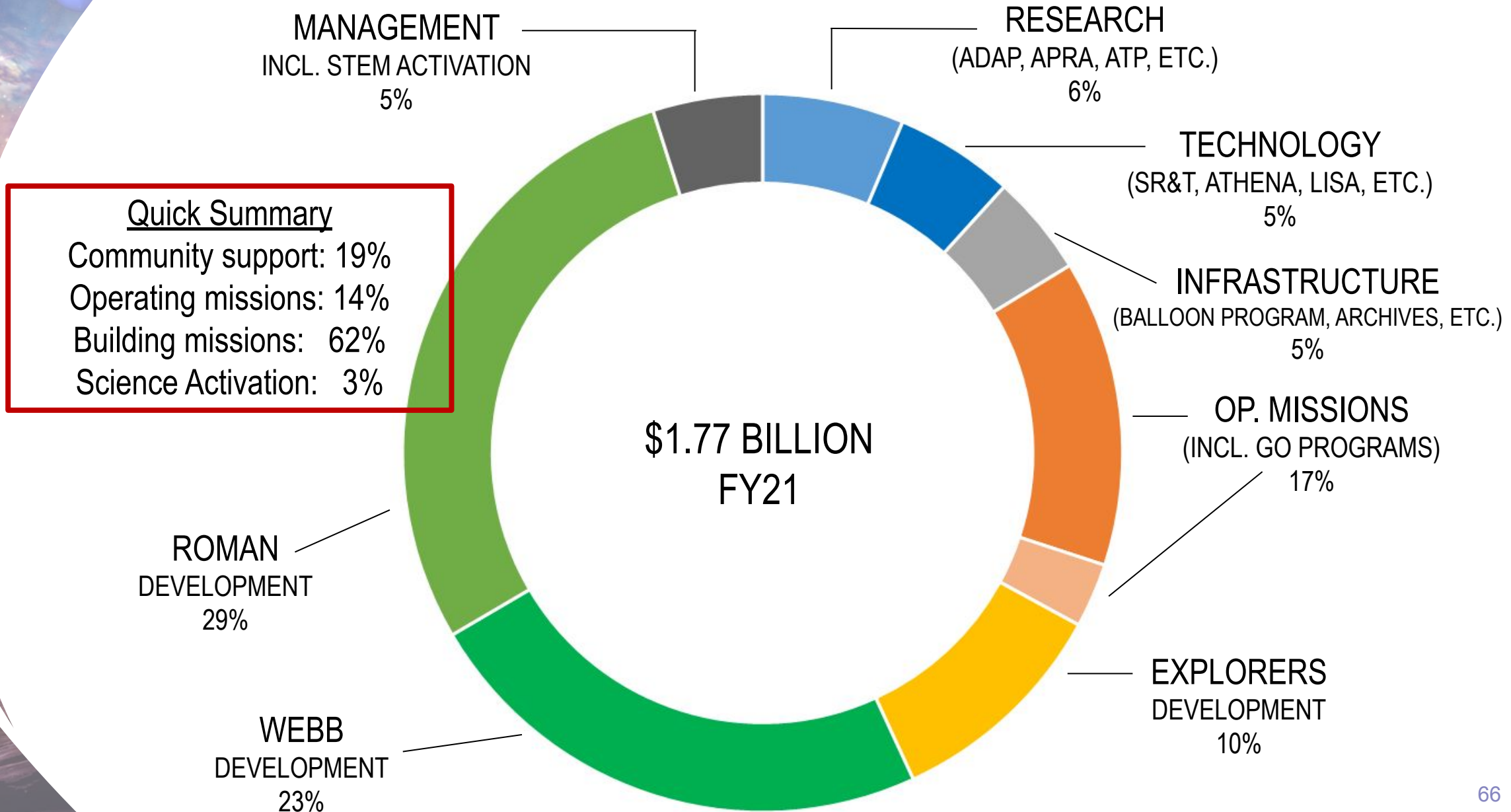

Planned Milestones FY21-22

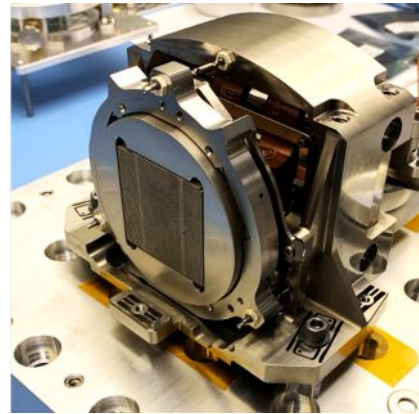
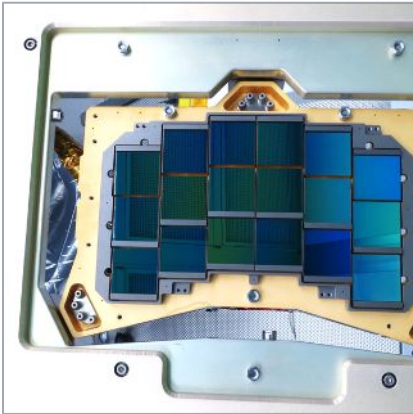
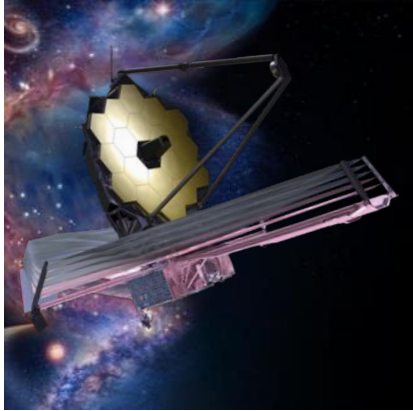

- Complete integration and launch Webb in 2021
- Complete integration and test for IXPE and launch by early 2022
- Achieve Roman Space Telescope critical design review in 2021
- Maintain decadal cadence of four AOs per decade for Astrophysics Explorers and Missions of Opportunity with a SMEX downselect and a MIDEX AO in 2021
- Receive Astrophysics Decadal Survey in 2021
- Achieve SPHEREx critical design review in 2022
- Conduct Senior Review of Operating Missions in 2022
- Generate world-class science from operating missions including Hubble Space Telescope and Chandra X-ray Observatory
- Maintain healthy research program including suborbital-class missions, technology development, data analysis, theoretical and computational investigations, and laboratory astrophysics
- Plan formulation or solicitation for a Probe mission
- Support mission concept studies and technology investments to implement Astrophysics Decadal Survey priorities starting in 2022

NASA's Small Satellite Missions at a Glance

SmallSat/CubeSat Missions & Investment by SMD Division

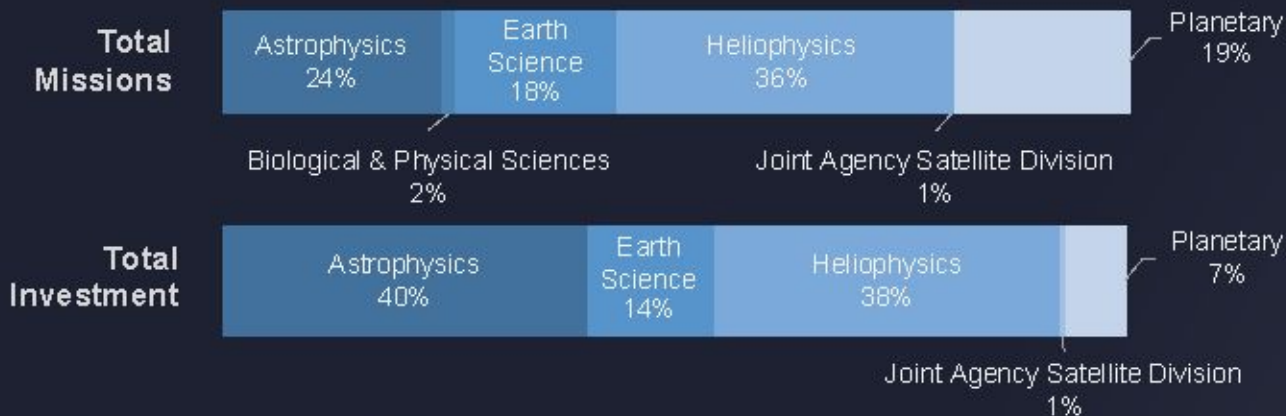

Mission Phase and Satellite Size

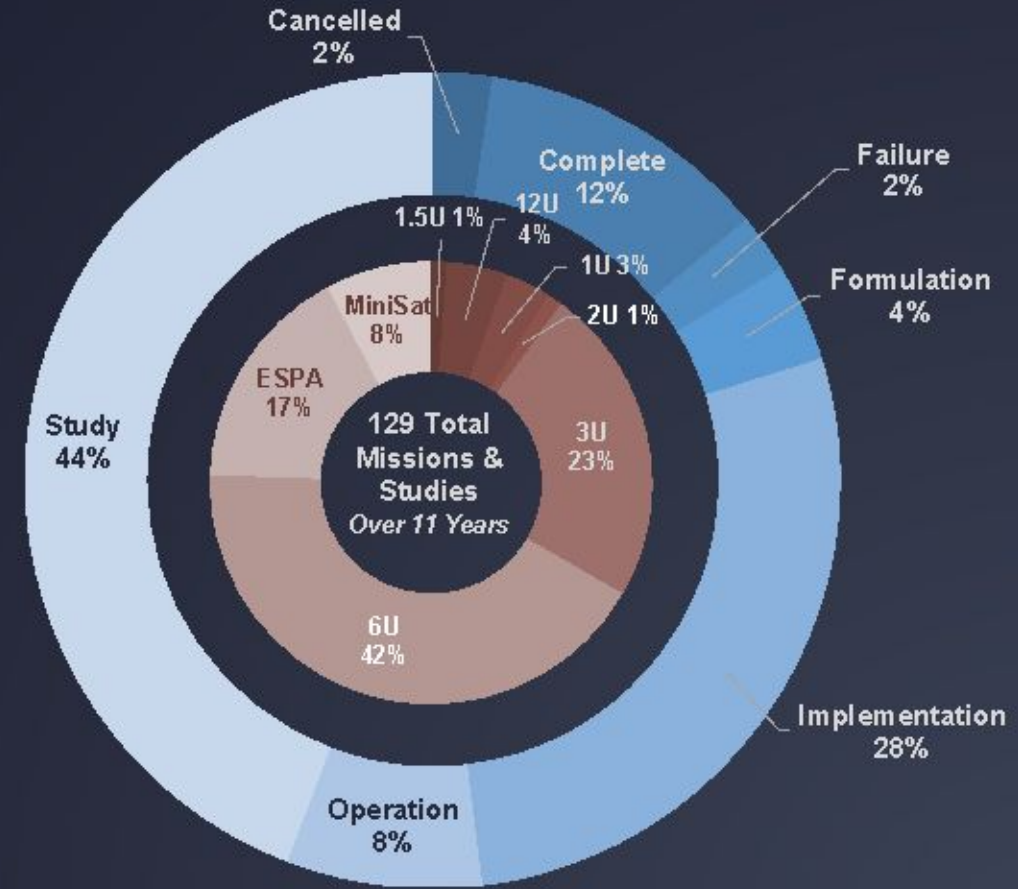

Mission Launch Timelines



\$2.27 B
Total Investment over 11 Years

41 SMD SmallSat Missions
(64 Spacecraft)
in Implementation
2021 and beyond