

NOT YET IMAGINED

A STUDY OF HUBBLE SPACE TELESCOPE OPERATIONS

CHRISTOPHER GAINOR

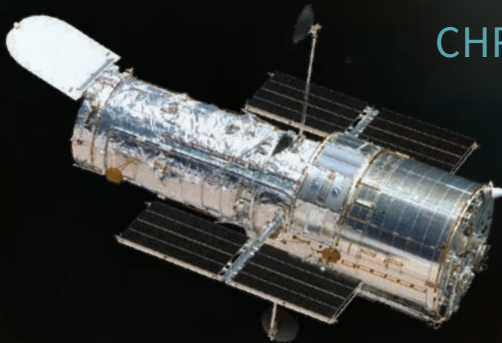

NOT YET
IMAGINED

NOT YET IMAGINED

A STUDY OF
HUBBLE SPACE TELESCOPE
OPERATIONS

CHRISTOPHER GAINOR



National Aeronautics and Space Administration

Office of Communications
NASA History Division
Washington, DC 20546

NASA SP-2020-4237

Library of Congress Cataloging-in-Publication Data

Names: Gainor, Christopher, author. | United States. NASA History Program Office, publisher.

Title: Not Yet Imagined : A study of Hubble Space Telescope Operations / Christopher Gainor.

Description: Washington, DC: National Aeronautics and Space Administration, Office of Communications, NASA History Division, [2020] | Series: NASA history series ; sp-2020-4237 | Includes bibliographical references and index. | Summary: "Dr. Christopher Gainor's Not Yet Imagined documents the history of NASA's Hubble Space Telescope (HST) from launch in 1990 through 2020. This is considered a follow-on book to Robert W. Smith's The Space Telescope: A Study of NASA, Science, Technology, and Politics, which recorded the development history of HST. Dr. Gainor's book will be suitable for a general audience, while also being scholarly. Highly visible interactions among the general public, astronomers, engineers, government officials, and members of Congress about HST's servicing missions by Space Shuttle crews is a central theme of this history book. Beyond the glare of public attention, the evolution of HST becoming a model of supranational cooperation amongst scientists is a second central theme. Third, the decision-making behind the changes in Hubble's instrument packages on servicing missions is chronicled, along with HST's contributions to our knowledge about our solar system, our galaxy, and our universe. A fifth theme of the book covers the impact of HST and the images it produces on the public's appreciation for the universe." Provided by publisher.

Identifiers: LCCN 2020014193 (print) | LCCN 2020014194 (e-book) | ISBN 9781626830615 (hardcover) | ISBN 9781626830622 (e-book)

Subjects: LCSH: Space Telescope History Project (U.S.) | Space telescopes—History.

Classification: LCC QB500.268 .G35 2020 (print) | LCC QB500.268 (e-book) | DDC 522/.2919—dc23

LC record available at <https://lcn.loc.gov/2020014193>

LC e-book record available at <https://lcn.loc.gov/2020014194>



This publication is available as a free download at <http://www.nasa.gov/ebooks>.



A vibrant, multi-colored nebula, likely the Orion Nebula, filling the upper half of the page. The colors range from deep reds and oranges to bright yellows and blues, with wispy, ethereal structures.

CONTENTS

▲ The Advanced Camera for Surveys (ACS) instrument aboard the Hubble Space Telescope captured this view of the Orion Nebula in 2006. (NASA/ESA/M. Robberto [STScI/ESI]/HST Orion Treasury Project Team: heic0601a)

	Foreword by Charles F. Bolden, Jr.	vii
	Preface	xi
PROLOGUE	Launching the Hubble Space Telescope	1
CHAPTER ONE	A Troubled History	9
CHAPTER TWO	Spherical Aberration	53
CHAPTER THREE	The Road to Recovery	77
CHAPTER FOUR	The Power of the Image	117
CHAPTER FIVE	New Instruments and New Directions	143
CHAPTER SIX	The Universe Turned Inside Out	175
CHAPTER SEVEN	The Fall and Rise of Hubble's Last Servicing Mission	209
CHAPTER EIGHT	Operating the Hubble Space Telescope	249
CHAPTER NINE	Astronomy: A Science Transformed	287
CONCLUSION	The World's Most Famous Telescope	329
	Appendices	343
	Acronyms	359
	Bibliography	361
	Acknowledgments	381
	The NASA History Series	389
	Index	403

FOREWORD

▲ Image of NGC 2174, the Monkey Head Nebula, taken by Hubble's Wide Field Camera 3 in 2014.
(NASA/ESA/Hubble Heritage Team [STScI/AURA]: heic1406a)



▲ Major General Charles F. Bolden, Jr., NASA Administrator 2009–2017. (NASA: 200907290001HQ)

by Charles F. Bolden, Jr.
NASA Administrator, 2009–2017

One of the highlights of my career at NASA was helping deploy the Hubble Space Telescope (HST) from the payload bay of the Space Shuttle Discovery on 25 April 1990, and watching Hubble begin its amazing decades exploring the universe from Earth orbit.

As pilot of the STS-31 mission, I spent much of that day at the aft station on Discovery's flight deck. There, I helped mission commander Loren Shriver fly the Shuttle and helped remote manipulator system (RMS) operator Steve Hawley lift HST out of the payload bay. As I read out position numbers to Steve and monitored Hubble's movements, Steve discovered that the robotic arm in space did not behave in the same way as the arm in the simulator on Earth. Steve had almost no room for error—there was barely enough room to fit my fist into the space between HST and the side of the payload bay—and so he had to spend nearly an hour more than expected slowly and gently moving the gigantic Hubble out of the payload bay by moving one joint of the RMS at a time.

Once HST was safely above the payload bay but still in the grasp of the robotic arm, we deployed Hubble's two antennas and the first of its two large solar arrays. The second solar array failed to fully deploy, and we worried about the limited battery time on HST running out before the solar array could deploy.

The decision was made that our other two crewmembers, Kathy Sullivan and (the late) Bruce McCandless, should get into their spacesuits and get ready to go outside and help deploy the solar array. I immediately went down to the middeck to assist Bruce and Kathy donning their extravehicular mobility unit (EMU) spacesuits and move into the airlock.

As we depressurized the airlock, we got word from Mission Control of a possible solution to the solar array problem. The HST control team at Goddard Space Flight Center transmitted a command that bypassed a software module in the telescope designed to protect the arrays from excessive tension that could damage an array. When a new deploy command was sent, the array opened properly. Loren maneuvered Discovery into the proper deploy attitude, Steve released HST from the robotic arm, and Loren moved the Shuttle away from Hubble, completing the deployment as I photographed the scene.

The moment was bittersweet because Bruce and Kathy, who may have had more time with Hubble than any other people on the planet, were still inside the airlock and missed the historic moment of deployment. At that time, no one in the astronaut office had done more work to prepare for this moment than Bruce and Kathy. My two crewmates had also helped devise tools and procedures to deploy and service HST. They had seen to it that Hubble was fitted with handholds and grapple fixtures, and their work paid off years later when it came time to service and repair HST on future missions.

Most of our crew had been named to the HST deployment mission nearly five years before we actually flew, so we had plenty of time to prepare, think, and talk about Hubble. We all agreed that Hubble would revolutionize astronomy and astrophysics, but looking back, I now realize that none of us had any idea of what a game changer it would be.

Our crew had even flown to England to visit the British Aerospace plant where HST's solar arrays were being built, but we did not realize how useful that trip would be for our deployment mission. Although we had thought about contingencies we might face, we didn't yet know how important Shuttle servicing missions would be to carrying on the work of the Hubble Space Telescope.

After we returned home from STS-31, I hoped to get another flight to HST. That didn't happen, but more than two decades later, after I had flown twice more to space and then wrapped up my career in the U.S. Marine Corps, Hubble returned to my life.

That came in 2004, after the tragic loss of the Space Shuttle Columbia and the crew of STS-107 caused NASA Administrator Sean O'Keefe to cancel the fifth and final HST servicing mission. I was asked to join a high-level committee of the National Academies reviewing options for extending the life of HST. Our

committee concluded that proposals to service HST using robotic spacecraft were not yet viable, and so we recommended that NASA permit another crewed servicing mission with additional safety measures.

That servicing mission (STS-125) ultimately flew in 2009, just weeks before I became Administrator of NASA. The mission's outstanding success meant that I never had to make a difficult decision about Hubble, but I had the pleasure of taking part in celebrations of its 20th and 25th anniversaries on orbit.

As HST reaches its 30th year in space with an amazing record of accomplishment, I thank all the people from all parts of NASA that have made these scientific achievements possible. That includes the people of Marshall Space Flight Center in Huntsville, Alabama, who supervised the building of HST; the people of Goddard Space Flight Center in Greenbelt, Maryland, who control Hubble and created the tools and techniques to repair it; the people of Johnson Space Center in Houston, Texas, where astronauts like me prepared for Shuttle servicing missions and where those missions were controlled; and the people of Kennedy Space Center in Florida, where Shuttles and their cargos, including HST and its replacement instruments, were prepared for flight and launched.

Our partners in the European Space Agency (ESA) have played a major role in HST in the form of solar panels, the Faint Object Camera, and scientists who made outsized contributions to Hubble's research findings.

Many contractors helped make HST a reality, including the Space Telescope Science Institute, which organizes HST's scientific work, and Lockheed Martin, which built Hubble and continues supporting the maintenance and control of HST.

Hubble's reach extends around the world because observing time on the telescope and its archives are open to anyone on Earth. Scientists from every part of the world and even a few amateur astronomers have been granted observing time on the Hubble Space Telescope. Larger numbers of people have used data from HST for their research projects.

As I write these words, Hubble and its instruments continue to provide world-leading science to the astronomers and astrophysicists around the world. With its five instruments and its Fine Guidance Sensors (FGS) also providing observations, Hubble is far more than a telescope—it's a fully equipped observatory.

Hubble has looked back most of the way to the early days of the universe, and we anticipate deeper views into the past with the James Webb Space Telescope.

This book, which examines HST's first three decades of operation, fulfills another NASA commitment, this one to disseminate our findings as widely as possible. We have learned many lessons from Hubble that are best explained

through histories such as this book. I hope it will help more people appreciate the phenomenal work done by the people of NASA, our partners at ESA, and our contractors, to make Hubble the gigantic success it has become.



PREFACE

▲ The Bubble Nebula, or NGC 7635, was crafted from Wide Field Camera 3 images in 2016.
(NASA/ESA/Hubble Heritage Team [STScI/AURA]: STScI-2016-13)

... the chief contribution of such a radically new and more powerful instrument would be, not to supplement our present ideas of the universe we live in, but rather to uncover new phenomena not yet imagined...

—Lyman Spitzer, Jr., 1946

The most important discoveries will provide answers to questions that we do not yet know how to ask and will concern objects we have not yet imagined.

—John N. Bahcall, 1990¹

The launch of the Hubble Space Telescope in 1990 began a lengthy period of scientific work in space that has reached 30 years and is continuing as this study is being completed. First and foremost, this book tells the story of HST operations during that time. That story is much bigger than HST itself. Hubble is a project of the National Aeronautics and Space Administration and the European Space Agency, and it also involves many private contractors, universities, and individuals. In addition to the space telescope itself, HST operations depended on NASA control centers on the ground, facilities where astronauts and others prepared deployment and servicing missions for HST using the Space Shuttle, a scientific institute that was created to serve scientists from many nations who have made observations with HST, and European Space Agency facilities. All of these facilities and institutions have evolved during HST's time on orbit.

The Hubble Space Telescope is almost unique amongst NASA programs and spacecraft in terms of its longevity. Spacecraft such as the two Voyagers have operated longer than HST, but their primary missions were completed

roughly 12 years after they were launched. The Chandra Space Telescope was launched nine years after HST and is still operating. The International Space Station has been on orbit for more than 20 years. HST has been carrying out its primary mission for 30 years and counting, thanks to five maintenance, repair, and replacement missions involving the Shuttle and its astronauts that have increased Hubble's capabilities over its lifespan. The last Shuttle servicing mission to Hubble took place in 2009, less than 20 years after HST was launched. Hubble has continued to operate without benefit of on-orbit servicing for more than a decade.

HST is still transmitting images and data to the ground for the use of scientists and, in some cases, the appreciation of the public, and there is a good prospect that it will continue to do so for years to come. Even after Hubble completes its final observation, it will still be far too early to properly assess the impact and importance of HST's scientific bounty, since many of its observations are going straight to archives where they may remain for years before they are used and their importance realized. Because Hubble is still actively exploring the universe, this book should be considered an early draft of history that discusses some events that took place decades ago and some that occurred as research and writing was going on.

NASA has statutory responsibility to "provide for the widest practicable and appropriate dissemination of information concerning its activities and the results thereof."² From its beginnings, NASA has included the study of history and historians within the meaning of this responsibility, centered in the NASA History Division at Headquarters. NASA has supported the creation of many quality books, monographs, and chronologies on its programs, and it maintains archives that relate to its work. NASA has assisted in historical work on HST that began long before it was launched in 1990, and the best-known product of this support was Robert W. Smith's 1989 book on how HST was transformed from an idea to a fully built space telescope ready for launch into space, *The Space Telescope: A Study of NASA, Science, Technology, and Politics*. That book remains the outstanding study of how HST was created and is noteworthy for its exploration of the interplay between scientists, engineers, politicians, and industrialists that shaped the Hubble Space Telescope and brought it to the launch pad in 1990 as a prime example of what has become known as Big Science.³

In 2014, nearly a quarter century after HST was launched, Goddard Space Flight Center issued a request for proposals to create a history of HST operations, along with an archive of documents and interviews with program participants to support this and future historical studies. I began research work on

this book later that year. The idea behind starting this study while Hubble was still operating was the reality that many participants in the early phases of the program were leaving the scene and some source documents were becoming more difficult to find. My work on this book has benefitted from strong support from NASA personnel at Goddard and the NASA History Division, which has agreed to publish this study. The work that led to this book has also been assisted by personnel from other NASA Centers, the Space Telescope Science Institute, and other NASA contractors, along with scientists who have used observing time and data from HST.

To understand HST operations, chapter one examines the events that brought HST to the launch pad in 1990. It is important to look back to how the ideas of space exploration and space astronomy led both to the Hubble Space Telescope and to the Space Shuttle that carried HST into space and then was used to mount servicing missions to it. Not all astronomers embraced the idea of HST, and its promoters had to work hard to win approval for the space telescope in the straitened economic circumstances of the 1970s. The HST program was often under managerial and financial stress that underlaid the error that was introduced into HST's main mirror while it was being ground and polished. The defect in the mirror forms the heart of the story of HST's first four years on orbit, which is outlined in chapters two and three, as scientists and engineers learned and absorbed what had happened to the mirror and then created and implemented solutions to the defect, known as spherical aberration, that resulted from the mirror's incorrect shape.

Once the mirror problem was overcome during the first Shuttle servicing mission in December 1993, HST quickly became one of NASA's signature programs, thanks to the images it has obtained of objects as close as the Moon and as far away as galaxies billions of light-years distant. As HST began operations, millions of people equipped with newly created personal computers tied together on a newly expanded computer network known as the internet acquired new ways of collecting images and other data from HST. Scientists have also gained undreamed-of online access to Hubble data thanks to these new means of communications. Chapter four examines HST's place in the advent of cyberspace and the power of its images in publicizing and promoting astronomy.

HST is unique among robotic spacecraft because it was serviced, repaired, and upgraded five times by Shuttle astronauts during its first 20 years on orbit. All of those servicing missions involved NASA's Space Shuttle training and launch facilities, along with the contractors who built the instruments, tools, and other equipment needed for these flights. Scientists who use HST played a major role in selecting and creating the instruments that were installed on

Hubble during those servicing missions. Each of these servicing missions had its own goals and its own history, which are related in this book. The stories of the second, third, and fourth servicing missions are recounted in chapter five.

As an observatory using the most powerful telescope launched into space at that time and a variety of instruments to image, measure, and analyze distant objects, Hubble has made a major impact on our understanding of the universe. Chapter six takes a preliminary look at HST's scientific output, starting with an examination of how teams of astronomers are using HST and other telescopes to determine the size and age of the universe with greater precision than ever before. These measurements led to the surprising discovery that the universe is expanding at an accelerating rate, which opened new questions about what the universe is made of. A series of "Hubble Deep Field" images has looked back to the early days of the universe. Other HST scientific advances include supermassive black holes in the centers of galaxies, views of the birth and death of stars, views of planets orbiting other stars, and tracking of weather on planets in our own solar system.

After the fourth Shuttle servicing mission visited HST in 2002, astronomers hoped to see Hubble's life extended well beyond its originally planned 15 years with one more servicing mission and hopes for another. But less than a year later, the loss of the Space Shuttle Columbia and its crew put the future of the Shuttle Program into question. By early 2004, NASA Administrator Sean O'Keefe had decided to cancel the fifth HST servicing mission, setting off an unexpectedly large controversy amongst astronomers and the public about the future of HST. Chapter seven outlines these events and the subsequent decision made by O'Keefe's successor Michael Griffin to proceed with the mission, which turned out to be a great success that has added more than a decade of life to HST.

Chapter eight focuses on the infrastructure back on Earth that supports HST and how it has evolved over the three decades of HST operations. The control facilities at Goddard and the scientific work of the Space Telescope Science Institute (STScI) began with preparations for Hubble's observing work prior to its launch. As HST changed over its time on orbit, so did these crucial facilities. This chapter also examines the European Space Agency's role in HST and the financial cost of the program.

As a unique and prominent astronomical facility with high demand for observing time and data, HST has driven change within astronomy as recounted in chapter nine. To obtain time on Hubble, astronomers have formed bigger research teams. The creation of STScI gave scientists a powerful voice in the running of HST, and the model has been adopted for similar facilities. NASA,

for its part, has become the major force in funding astronomy in the United States. Both NASA and STScI have been involved in opening astronomy to female astronomers and also to scientists from visible minorities, but that effort has not always been easy. Where once observatories were private and data were the property of individual observers, HST as a public facility has opened data availability to the public.

While HST has long been known as an example of Big Science, this book will argue that it has also helped create what I call mass science by encouraging the creation of larger teams in astronomical studies and by making astronomical data available to the public. Hubble's high profile has raised the prominence of astronomy at a time when the numbers of professional astronomers have been growing. NASA has fostered this growth by providing financial support to astronomers using HST and other space telescopes and by creating the infrastructure that supports these instruments. Thanks in part to its prominent status in the early years of the internet, HST has allowed large numbers of people who had never looked through a telescope to explore the heavens in the comfort of their own homes. The fact that the internet came into wide use in the early years of Hubble operations made HST an early star of the online world and had a major impact on HST's relationship with astronomers and, more importantly, the public at large.

Hubble also was a key part of the Space Shuttle Program because of the six Shuttle missions that deployed and serviced it. Many of the techniques developed to help astronauts keep HST flying were applied to build the International Space Station (ISS). This book will discuss the evolution of HST servicing that started well before the first servicing mission. It will also explore the little-known processes involved in choosing the instruments that were placed on board HST during those servicing missions. While those changes to Hubble have been well publicized, the infrastructure that supported it on the ground is not as well known, and so a major theme of this study is the evolution of that infrastructure, especially the control center at Goddard and the science center for Hubble at STScI.

HST is one of the most famous projects undertaken by any space agency. Although it is a robotic spacecraft, it was regularly visited and serviced by astronauts. It was not the first telescope to fly in space, but it was the first designed to meet public expectations of images of various objects populating our universe. Its main mission was to observe the universe in ways previously not possible, and the data it has returned have sharpened and expanded humanity's view of the universe while raising new questions about its nature. Space telescopes that are following Hubble are taking different forms and have different purposes.

We have already learned that the creation of HST held many lessons about large scientific programs, and its lengthy period of operations in space contains many more lessons about high-profile science that are recounted in the pages that follow.

ENDNOTES

- 1 Spitzer quotation from “Astronomical Advantages of an Extra-Terrestrial Observatory,” Project RAND, 30 July 1946. Bahcall was quoted in Timothy Ferris, “The Space Telescope: A Sign of Intelligent Life,” *New York Times* (29 April 1990): A1.
- 2 Section 203 (a)(3), National Aeronautics and Space Act of 1958, Public Law No. 85-568, 72 Stat., p. 426. Signed by the President on 29 July 1958, Record Group 255, National Archives and Records Administration, Washington, DC; available in NASA Historical Reference Collection, History Office, NASA Headquarters, Washington, DC (hereafter “HRC”).
- 3 Robert W. Smith, *The Space Telescope: A Study of NASA, Science, Technology, and Politics* (Cambridge: Cambridge University Press, 1989). Cambridge published a paperback edition of this book with additional material in 1993. This work uses the 1993 edition for reference.



PROLOGUE

Launching the Hubble Space Telescope

▲ In December 2010, WFC3 recorded this view of the UGC 1810 galaxy within the constellation Andromeda. (NASA/ESA/Hubble Heritage Team [STScI/AURA]; heic1107a)

One of the most anticipated launches of the Space Shuttle era took place on Tuesday, 24 April 1990. After many delays, including one scrubbed launch attempt two weeks before, the Space Shuttle orbiter Discovery and its crew of five astronauts left Launch Complex 39B at John F. Kennedy Space Center in Florida at 51 seconds past 8:33 a.m. eastern daylight time atop a thundering pillar of brilliant flame, piercing a cloud as it rose through a generally clear sky.¹ Soon the Shuttle tilted nearly due east en route to an orbit at a standard inclination of 28.45 degrees from the equator. Nearly 9 minutes after launch, the Shuttle engines stopped firing and Discovery cast off its fuel tank as it coasted up to what was then a record altitude for a Shuttle of 618 kilometers (384 statute miles), an orbit that was circularized at that altitude with a thruster firing three quarters of an hour after launch.²

The focus of excitement around the launch was Discovery's payload, a huge satellite known as the Edwin P. Hubble Space Telescope (HST) that nearly filled the Shuttle's payload bay. While a number of space telescopes had flown starting in the 1960s, many people inside and outside the astronomical community looked forward to the deployment of the HST, which would be much more powerful and versatile than any previous astronomy satellite. The National Aeronautics and Space Administration (NASA) began working in earnest on the space telescope in 1977, and it became an international project when the European Space Agency (ESA) signed on that year as a partner on the space telescope.³

As launch day approached, the news media provided lavish coverage of the Hubble Space Telescope, explaining that it weighed nearly 11,000 kilograms



▲ The Space Shuttle Discovery carrying the Hubble Space Telescope into space on the STS-31 mission shortly after launch from Kennedy Space Center on 24 April 1990. (NASA: KSC-90PC-0633)

(24,000 pounds) and was 13.2 meters (43 feet) long and 4.2 meters (14 feet) in diameter, comparable in size to a school bus or a railroad tank car. Hubble's 2.4-meter (94-inch) main mirror was designed to direct light to a 0.3-meter (12-inch)-diameter secondary mirror that in turn reflected light to the telescope's five science instruments and its three Fine Guidance Sensors (FGS). The space telescope was reported to cost \$2.1 billion and was expected to operate for 15 years or more. Many media reports highlighted the accuracy and smoothness of the main mirror—quoting the statement of its maker that if the mirror were enlarged to the size of Earth, it was so smooth that its highest peak would only be five inches (127 millimeters) tall.⁴

Some of the media accounts also tried to predict what the space telescope would discover as it looked at everything from nearby planets to objects at the fringes of the universe. The *Washington Times* said HST would tackle questions includ-

ing: “How did the universe start? How will it end? Are there other worlds?”⁵ *USA Today* also speculated on Hubble's ability to find planets orbiting other stars. Both the *New York Times* and *Washington Post* compared HST's effect on astronomy to Galileo's first glimpses of the heavens with the newly invented telescope back in 1609.⁶

Astronomers involved with the program also weighed in. “If we are disappointed, it's not the telescope's fault or our fault,” astrophysicist John N. Bahcall of the Institute for Advanced Studies in Princeton, New Jersey, told the *New York Times* magazine. “It will be because of a lack of imagination on the part of God.”⁷ Lennard A. Fisk, NASA Associate Administrator for Space Science,

said, “Hubble will be a turning point in humankind’s perception of itself and its place in the universe. Hubble represents the single biggest leap in astronomy since Galileo.”⁸

Amidst the superlatives, other accounts took a more critical stance, notably the *Wall Street Journal*, whose reporter Bob Davis called Hubble “an example of Big Science gone bad,” and a “case study of how science projects get out of hand.” The article detailed the telescope’s tangled history along with its politically motivated design compromises and shortcomings, comparing it to two other large and controversial science-related projects, NASA’s space station and the Energy Department’s superconducting supercollider.⁹ The *Washington Post* noted that some “Hubble hype” had become overblown and quoted historian Robert W. Smith’s statement that HST “has become the single most expensive scientific instrument ever built.”¹⁰



▲ An IMAX camera in the rear of Discovery’s payload bay obtained this image of the Hubble Space Telescope moments after its release into space by the Space Shuttle Remote Manipulator System on 25 April 1990 during the STS-31 mission. (NASA: 9015550)



▶ A “fish-eye” lens captured this view of the aft flight deck of Space Shuttle Discovery while crew members were looking out overhead windows at the Hubble Space Telescope during the telescope’s deployment. From front (foreground) to back are Loren J. Shriver, commander, along with Steven A. Hawley and Bruce McCandless II, both mission specialists. (NASA: S31-10-027)

▶ The mission insignia for NASA’s STS-31 mission features the Hubble Space Telescope against a background of the universe. (NASA: 8915493)



▲ The STS-31 crew posed in Discovery’s middeck for an in-flight portrait. Loren J. Shriver, mission commander, is at the lower left. Astronaut Charles F. Bolden, pilot, floats above. Others, left to right, are Kathryn D. Sullivan, Bruce McCandless II, and Steven A. Hawley (holding a model of the Hubble Space Telescope), all mission specialists. (NASA: S31-12-031)

Although the mission was known officially as STS-31 under the Shuttle's convoluted flight designation scheme, its importance to NASA was shown by the fact that the crew on board Discovery was made up entirely of veteran astronauts. Piloting the Shuttle were commander Loren J. Shriver and pilot Charles F. Bolden, who nearly 20 years later would become Administrator of NASA. Steven A. Hawley, who was educated as an astrophysicist, had responsibility for deploying HST using the Shuttle's remote manipulator system, and two veteran spacewalkers, Bruce McCandless II and Kathryn D. Sullivan, had trained for an emergency spacewalk should the deployment of the space telescope run into problems.¹¹

Discovery's payload bay doors opened shortly after it entered orbit, and soon Hawley activated the Shuttle's 15-meter (50-foot)-long Canadian-built robotic arm. When the crew powered up HST's systems from the Shuttle four and a half hours into the mission, Hubble radioed its condition to the Space Telescope Operations Control Center at Goddard Space Flight Center in Greenbelt, Maryland. The next morning, Hawley grasped HST with the arm. Once the four latches holding HST inside the payload bay were released, the umbilical cord that fed electricity to Hubble from the Shuttle was unplugged and the telescope began operating under its own power. Veteran astronaut F. Story Musgrave in the mission control room in Houston gave Hawley the go-ahead to lift the space telescope out of the payload bay. Using the robotic arm, Hawley carefully lifted HST away from its tight fit inside the payload bay and turned the telescope around to its deployment position, although the operation took about 25 minutes longer than expected because the robotic arm's movements of HST were slightly different from what was expected based on simulations. Because Hubble's batteries could only power the spacecraft for six and a half hours without a charge from its two solar panels, the deployment of the solar panels had long been a matter of great concern, and this concern grew with the delay in moving HST out of the payload bay. The booms holding the panels unfolded from the body of the telescope, as did two high-gain antennas. The solar panels on the port side unfurled smoothly, but the starboard solar panels stalled and refused efforts by the crew and ground controllers to resume unfurling. McCandless and Sullivan donned their spacesuits, began to depressurize their airlock, and prepared to exit the Shuttle and manually unfurl the starboard solar panels. At the same time, engineers on the ground devised a procedure to bypass a sensor that had erroneously detected excessive tension on the panel and stopped the deployment. The fix worked, and the starboard panels unfurled without need of help from the astronauts.¹²

After Musgrave gave the "go for Hubble release" permission to the Shuttle crew, Hawley released the snares at the end of the robotic arm that held

Hubble and backed the arm away. HST's first moment of free flight took place at 3:37:51 p.m. eastern daylight time (EDT) on 25 April over the Pacific Ocean, on Discovery's 20th orbit, one orbit later than planned. Soon the Shuttle began to move 80 kilometers (50 miles) behind Hubble, where it remained for two days. A little more than five days after it was launched, Discovery landed on 29 April as planned at Edwards Air Force Base in California, leaving behind the space telescope.¹³

Acclaim for Hubble started to pour in as soon as it was launched, from the floor of Congress to the editorial page of the *New York Times*, which called Hubble's deployment "among NASA's finest achievements," adding that the telescope "may also constitute a triumph for Big Science."¹⁴ That weekend, science writer Timothy Ferris noted that astronomy is rife with incidents where telescopes and their equipment fail, which meant that "nobody really knows" how well Hubble would work. The big question in the minds of optimistic scientists at the time concerned the surprising discoveries Hubble could make, Ferris wrote: "The launching of the Hubble Space Telescope lofts human thought into the realm of the unexplored."¹⁵ HST was embarking on a journey where it would make good on its promise to challenge the imaginations of scientists. As hinted by Ferris, HST would also challenge the imaginations of the engineers, scientists, administrators, and politicians responsible for its operations, along with those of millions of people who would follow HST by new technological means not even created when the space telescope departed Earth.

ENDNOTES

- 1 Discovery lifted off 2 minutes 52 seconds after the scheduled time when a liquid-oxygen valve problem cropped up with just 31 seconds left in the countdown. STS-31's first launch attempt two weeks earlier on 10 April had ended with 4 minutes left in the countdown when an auxiliary power unit on the Shuttle failed. STS-31 was the 35th launch of the Space Shuttle Program and the tenth since the loss of Challenger.
- 2 Joel W. Powell and Lee Robert Brandon-Cremer, *Space Shuttle Almanac: A Comprehensive Overview of 40 Years of Space Shuttle Development and Operations* (Calgary: Microgravity Productions, and Sydney: Launch Pad Publishing, 2011), p. 256; Robert A. Adamcik, *Voyages of Discovery: The Missions of the Space Shuttle Discovery* (Burlington, Ontario: Apogee Books, 2012), pp. 51–54.
- 3 Joseph J. McRoberts, *Space Telescope* (Washington, DC: NASA, 1982).
- 4 NASA, "Space Shuttle Mission STS-31 Press Kit," April 1990, pp. 14, 15. Both the *New York Times* and the *Washington Post* estimated HST's cost at \$2.1 billion, close to the \$2 billion cost mentioned by Robert W. Smith, *The Space Telescope: A Study of NASA, Science,*

- Technology and Politics*, p. 371. See Kathy Sawyer, “Hunting the ‘Blueprint of Eternity,’ Long-Delayed \$2.1 Billion Hubble Space Telescope Set for Launch,” *Washington Post* (8 April 1990): A1; John Noble Wilford, “Telescope Is Set to Peer at Space and Time,” *New York Times* (9 April 1990): A1.
- 5 Jay Mallin, “Space Telescope Will Peek into Uncharted Frontiers,” *Washington Times* (10 April 1990): A4.
 - 6 Paul Hoversten, “Telescope Will Seek Planets of Other Suns,” *USA Today* (6 April 1990): 3A; Sawyer, “Hunting the Blueprint.”
 - 7 John Noble Wilford, “The Search for the Beginning of Time,” *New York Times Magazine* (11 February 1990): 59.
 - 8 Douglas Isbell, “Hubble Launch Starts Era of Great Space Observatories,” *Space News* (April 1990): 2–8.
 - 9 Bob Davis, “Hubble Space Telescope, Plagued by Problems, May Open the Heavens but Has Cost the Earth,” *Wall Street Journal* (5 April 1990): A20.
 - 10 Sawyer, “Hunting the Blueprint.”
 - 11 For most of the Shuttle Program, mission numbers were assigned early in the mission preparation process and did not change when the launch order of missions changed. “STS-31 Press Kit,” pp. 61–62. Sullivan became the first American woman to walk in space in 1984, the same year McCandless became the first human to walk in space without being tethered to a spacecraft.
 - 12 Kathy Sawyer, “Hubble Telescope Spreads Its Wings,” *Washington Post* (26 April 1990): A1; John Noble Wilford, “Telescope Is Orbited After a Tense Delay,” *New York Times* (26 April 1990): B12; *STS-31 Mission Highlights Resource Tape* (Washington, DC: NASA, 1990), author’s collection; Steven A. Hawley, “How Launching Hubble Space Telescope Influenced Space Shuttle Mission Operations,” *Journal of Spacecraft and Rockets* 51, no. 2 (March–April 2014): 385–396; Kathryn D. Sullivan, *Handprints on Hubble: An Astronaut’s Story of Invention* (Cambridge, MA: The MIT Press, 2019), pp. 209–216; Kathryn D. Sullivan oral history interviews, Columbus, OH, by Jennifer Ross-Nazzal, 12 March 2008 and 28 May 2009, Johnson Space Center Oral History Project; Charles Bolden, Oral History Interview by author, 31 October 2017, pp. 1–3; Rockwell International Office of Media Relations, “STS-31 Press Information” (pub 35–46, April 1990), pp. 15–20; Douglas Isbell, “Hubble Scheduled for Two-Day Checkout by Shuttle Crew,” *Space News* (April 1990): 2–8; Roelof Schulling and Steven Young, “STS-31 Mission Report: A New Window on the Universe,” *Spaceflight* 32, no. 6 (June 1990): 196–206.
 - 13 Sawyer, “Hubble Spreads Its Wings”; Wilford, “Telescope Is Orbited”; *STS-31 Mission Highlights Resource Tape*; Hawley, “How Launching HST Influenced Shuttle Operations,” p. 394; Sullivan, *Handprints on Hubble*, pp. 216–219; Story Musgrave, oral history interview by author, 25 October 2016, pp. 12–13.
 - 14 “Harvesting the Universe,” *New York Times* (26 April 1990); John G. Rowland, “The Mirrors of the Hubble Space Telescope,” *Congressional Record*, (24 April 1990), available in NASA HRC, file 5982.
 - 15 Timothy Ferris, “The Space Telescope: A Sign of Intelligent Life,” *New York Times* (29 April 1990): A1.



CHAPTER ONE

A Troubled History

▲ Composite image of the Small Magellanic Cloud prepared from data from the Hubble, Spitzer, and Chandra Space Telescopes in 2013. (NASA/CXC/JPL-Caltech/STScI: PIA16884)

When Discovery carried the Hubble Space Telescope into space on 24 April 1990, there were many reminders of the history that had led to that event. One of the many spectators at the launch site was Lyman S. Spitzer, Jr., the physicist who was often credited with drawing up the first serious proposal in 1946 for a large space telescope and for advocating for it in the 44 years that followed. The crew of Discovery carried with them an eyepiece from the Mount Wilson Observatory in California that had been used by the telescope's namesake, Edwin P. Hubble, to guide his observations in the 1920s.

The name most often mentioned that day other than Hubble was that of Galileo Galilei, the Italian astronomer, mathematician, and philosopher who is widely credited as the first person to point a telescope to the skies.¹ Galileo used a small refracting telescope for his observations starting in 1609 that relied on lenses to gather more light than the human eye is capable of gathering. The telescopic observations he recorded of the Moon, the satellites of Jupiter, and the phases of Venus revolutionized humanity's view of the universe and inspired many others to create telescopes of their own. In the 1660s, Isaac Newton in England and Laurent Cassegrain in France designed and built the first reflecting telescopes—telescopes that used concave curved mirrors instead of lenses to gather light. While both types of telescopes have remained in wide use to the present day, the reflecting telescope became the instrument of choice for professional astronomers in the 20th century due to the technical limitations presented by refractors beyond a certain size. The Hubble Space Telescope is an advanced version of Cassegrain's design for a reflecting telescope.²

Newton's many contributions to the theory and practice of physics and astronomy also included the experimental observation that white light is made up of many colors that can be observed when the white light passes through a prism, and that the colors could be reassembled into white light when passed through another prism. Newton's simple observation, which overturned the conventional wisdom of the time, led to further discoveries in the 19th century that the spectrum of light created by a prism could reveal the composition of the light source. Astronomers started to take photographs in 1840, and for much of the time since then, their medium of choice was black-and-white images on glass photographic plates. For astronomy, photography meant not only the ability to image objects in the sky, but also to preserve the spectra of the Sun, stars, and other celestial objects in the form of spectrograms. Spectra of stars and nebulae revealed their motion and, in time, also permitted astronomers to determine their temperature and composition.³

Physicists and astronomers picked up these new tools to learn more about the nature of the Sun, the planets in our solar system, and the stars and other bodies that lay beyond. As the 20th century began, most scientists believed that the Milky Way constituted the entire universe, but some began to wonder whether the universe extended far beyond our home galaxy. Funded mainly by philanthropists, larger telescopes were built in the 19th and early 20th centuries in the United States to gather more light from dim and distant objects. By the beginning of the 1920s, the largest telescope on Earth was the 100-inch (2.54-meter) Hooker reflector at Mount Wilson in California.⁴

It was at Mount Wilson in the early 1920s that Edwin Hubble, who was establishing himself as an astrophysicist, created the images that he used to confirm that our universe is populated with large numbers of other galaxies beyond our own. These findings vastly enlarged the size of the universe in the eyes of astronomers. He also found evidence that those galaxies are flying apart from one another, which convinced many astronomers that the universe is expanding. NASA named the Space Telescope after Hubble in 1983 because it had as one of its primary scientific goals refining Hubble's findings on the size and expansion of the universe.⁵

Edwin Hubble was born in Marshfield, Missouri, in 1889 and studied mathematics and astronomy at the University of Chicago. After winning a Rhodes scholarship, Hubble bowed to his father's wishes and studied law at Oxford University. After a year teaching high school, he returned to the study of astronomy at Yerkes Observatory and the University of Chicago, where he earned a Ph.D. in astronomy. After serving in the U.S. Army in World War I, Hubble joined the staff at Mount Wilson, where he did his groundbreaking work that will be discussed in detail in chapter six.⁶

Mount Wilson's successor as the world's largest telescope was the 200-inch (5.08-meter) Hale Telescope on Mount Palomar in California, which provided precedents for both the excitement and the problems that surrounded HST. After General Electric tried and failed to create a test mirror using a new type of glass that would avoid the shape changes caused by temperature fluctuations that afflicted the Mount Wilson telescope, Corning Glass succeeded in creating a full-sized mirror on its second try in 1934. Grinding and polishing the gigantic mirror took several years, including a long interruption while resources were diverted during World War II. Twenty years after work began on the project, the telescope was dedicated in a great public ceremony on 3 June 1948, in front of 1,000 guests. Members of the press were shown Saturn through the 200-inch telescope that night, the quality of the image limited by "conditions of poor visibility." By the end of the summer, the telescope and its dome had appeared on a United States postage stamp. But even before the dedication ceremony, observatory technicians knew that the instrument had a set of "bugs" that required it to be taken offline until October 1949. During that time, technicians made changes to the mount and the mirror supports and did final polishing to fine-tune the shape of the mirror. Edwin Hubble's career at Mount Wilson had also been interrupted by service in World War II, and declining health permitted him to make only a handful of observations using the 200-inch telescope at Mount Palomar prior to his death in 1953. The Hale Telescope remained the world's largest and best-known telescope for more than a quarter century after it went into operation.⁷

SURMOUNTING THE ATMOSPHERE

By the time the Hale telescope was dedicated, scientists were beginning to talk about sending telescopes into outer space. Astronomers already knew that turbulence in Earth's atmosphere blurs celestial objects to observers on the ground, and more importantly, the atmosphere absorbs light in most spectral bands outside those visible to human eyes. Inspired by fictional accounts of space travel and the beginnings of powered flight by aircraft in 1903, enthusiasts in Russia, the United States, and several European countries began to think and write about humans flying into space. In 1919, a physics professor from Clark University in Massachusetts, Robert H. Goddard, published a paper containing theories and experimental results from his studies of rockets. In January 1920, portions of that paper appeared in newspapers, including Goddard's speculation that a rocket could fly to the Moon. The resulting publicity inspired a wave of enthusiasm for rocketry and space travel that extended to Europe and even the Soviet Union. In 1923, Hermann Oberth, a German-Romanian



▲ Hermann J. Oberth (1894–1989) contributed many ideas to the development of rocketry and space exploration, including placing telescopes in space. (NASA)

teacher, wrote that placing a telescope in Earth orbit would have many benefits for astronomers. Rocket enthusiasts in several countries, including Goddard himself, developed liquid-fueled rockets that proved much more powerful than the gunpowder rockets of the time. Just as Adolf Hitler came to power in Germany in 1933, the German Army began supporting the development of rocket weapons, culminating in the V-2, which showed the potential of long-range rockets for military and peaceful purposes.⁸ From 1946 to 1952, scientists used captured and reconstructed German V-2 rockets brought to the United States to launch scientific instruments to high altitudes, where they could study the Sun and the upper atmosphere, and to advance their own expertise with long-range ballistic missiles. While some results from these instruments tantalized scientists, problems

with both rockets and instruments proved that rocket-borne scientific research was very difficult. As the supply of V-2s ran out, researchers turned to more reliable sounding rockets developed in the United States and stratospheric balloons to carry instruments to high altitudes.⁹

Wartime advances in rocketry caused some experts to consider the possibilities of using rockets to carry artificial satellites into orbit around Earth. Project RAND, a think tank set up in 1946 to carry out research for the U.S. Army Air Forces, issued its very first report that year on the topic of such a satellite with contributions from many experts.¹⁰ Lyman Spitzer, an astronomer at Yale University who soon moved on to become director of the Princeton University Observatory, contributed a paper titled “Astronomical Advantages of an Extraterrestrial Observatory.” There, Spitzer proposed placing a small spectroscope in orbit to look at the Sun and Earth’s upper atmosphere in the ultraviolet part of the spectrum that is blocked by Earth’s atmosphere, along with a 10-inch (.254-meter) Reflecting Telescope to look at the Sun and other stars in ultraviolet wavelengths. He suggested that in the future, a large reflecting telescope as big as the 200-inch telescope then being built at Mount Palomar—or even larger, up to 600 inches (15.24 meters) in aperture—be put in space. While

building all these space telescopes would involve major technical hurdles, the advantages would be great—getting above the turbulence of Earth’s atmosphere that disrupts the view of what lies above it and opening up the full electromagnetic spectrum. “It should be emphasized,” Spitzer presciently wrote, “that the chief contribution of such a radically new and more powerful instrument

would be, not to supplement our present ideas of the universe we live in, but rather to uncover new phenomena not yet imagined, and perhaps to modify profoundly our basic concepts of space and time.” Such a gigantic space telescope, he wrote, would help astronomers determine the extent of the universe, study the structures of galaxies and globular clusters, and learn about other planets in the solar system.¹¹

Spitzer’s paper was classified for several years, and many of his colleagues questioned the need for telescopes in space—questions that persisted well into the 1960s. Robert W. Smith, who chronicled the creation of HST in his masterful book *The Space Telescope: A Study of NASA, Science, Technology and Politics*, wrote that American astronomers were divided geographically. Those on the West Coast, who had access to large observatories in favorable locations

such as Mount Wilson and Mount Palomar that they were using to make exciting discoveries such as quasars, were not enthusiastic about space telescopes. Astronomers from the East Coast, who had to get by with smaller telescopes and poor observing conditions, were more interested in the concept. Many astronomers opposed the space telescope because of the great cost and limited success of early rocket-borne and satellite science packages at a time when observations from ground-based observatories were advancing astronomical knowledge.¹²

While the wider 1946 RAND report on satellites initially collected dust, the deepening Cold War between the United States and the Soviet Union drove interest in large rockets and artificial satellites. Both sides began military missile programs after World War II, and by the late 1950s, the superpowers began



▲ Astrophysicist Lyman S. Spitzer, Jr. (1914–1997) wrote the first detailed proposal to place a large telescope in space and championed what became the Hubble Space Telescope through the rest of his life. (Robert Matthews, Princeton University)

to build rockets that could deliver nuclear weapons anywhere on Earth. The same rockets, used as launch vehicles, could also carry payloads into Earth orbit and beyond.

In the early 1950s, scientists began to discuss launching artificial satellites to provide data on the upper reaches of Earth's atmosphere as part of a worldwide research effort to take place in 1957 and 1958 known as the International Geophysical Year (IGY). When the U.S. government announced in 1955 that it would orbit a satellite during IGY, the Soviet Union replied with a similar announcement. The Soviets used their intercontinental ballistic missile to launch the first artificial satellite of Earth, Sputnik, in 1957, and a surprised U.S. military scrambled to match the feat. Soon both superpowers began launching satellites, probes to the Moon and beyond, and the first humans into space in a Cold War competition, culminating in 1969 when the United States landed the first humans on the Moon.¹³

THE SPACE AGENCY

America's first satellites, Explorer and Vanguard, quickly proved the scientific value of robotic spacecraft when they made important discoveries about Earth's atmosphere and magnetic field. In the wake of Sputnik, the U.S. government established the National Aeronautics and Space Administration in 1958 to run America's civilian space program, including its scientific components. NASA was formed from the former National Advisory Committee for Aeronautics, which itself was made up of four different research and test facilities. The new agency also absorbed the U.S. Navy team that led the Vanguard satellite program and other scientists from the Naval Research Laboratory, which together formed the core of NASA's Robert H. Goddard Space Flight Center (GSFC), which began operations in 1959 in Greenbelt, Maryland. The Jet Propulsion Laboratory (JPL) in Pasadena, California, which had been run by the California Institute of Technology for the U.S. Army, also came under NASA's wing in 1959. In 1960, NASA absorbed much of the U.S. Army rocket team in Huntsville, Alabama, that had grown from the group of about 100 German rocket experts headed by Wernher von Braun, whom the Army had brought to the United States after World War II. This team formed the core of NASA's George C. Marshall Space Flight Center (MSFC), named after the great soldier and diplomat. The Marshall team initially was charged with building the Saturn rockets that boosted Apollo spacecraft toward the Moon. As the space race geared up in the 1960s, NASA established the John F. Kennedy Space Center (KSC) in Florida next to U.S. Air Force launch facilities at Cape Canaveral. NASA's human space programs were based in Houston, Texas, at what has been known

since 1973 as the Lyndon B. Johnson Space Center (JSC). NASA also worked closely with large and small aerospace contractors to build its spacecraft. With its various Centers located around the United States, the new Agency was not a single entity but a “coalition of quite disparate groups,” a reality that would strongly impact the development of HST.¹⁴

Despite the fact that astronomy and other space sciences had to compete inside the Agency with the high-profile and well-funded human space program, NASA quickly began an astronomy program that supported many astronomical research efforts using sounding rockets, balloons, and satellites. The Agency moved quickly to build satellites such as the Orbiting Solar Observatories, which first flew in 1962; the Orbiting Geophysical Observatories; and the Orbiting Astronomical Observatories (OAO). The first OAO failed shortly after launch in April 1966, but OAO-2 and its set of instruments in ultraviolet wavelengths operated for more than four years after being launched in December 1968. The third OAO failed to reach orbit, but the fourth of the series, which was named Copernicus, operated successfully from its launch in August 1972 until 1981, and the instruments attached to its 32-inch (80-centimeter) telescope included an ultraviolet spectrometer that sent back a great deal of data. Spitzer, whose dream of telescopes in space first became reality with OAO, was a Principal Investigator on Copernicus.¹⁵

THE LARGE SPACE TELESCOPE

As America’s human space program expanded to meet President John F. Kennedy’s 1961 goal of landing astronauts on the Moon by the end of the 1960s, space scientists from various organizations gathered in Iowa City in the summer of 1962 with space scientist James Van Allen of the University of Iowa in the chair. The scientists formed a working group to discuss the future of scientific research in space, and its recommendations included what became known as the Large Space Telescope (LST) to be placed into Earth orbit, with an aperture of about 2.5 meters (100 inches). Not all astronomers supported the idea, and a proposal for a formal study by the National Academy of Sciences failed to win sufficient support. The academy changed its position and approved a study after a similar meeting of astronomers who supported the space telescope took place under NASA sponsorship in 1965 in Woods Hole, Massachusetts.¹⁶ Homer E. Newell, Jr., who directed space science at NASA Headquarters, told the American Astronomical Society (AAS) that the LST would require widespread support from astronomers to succeed. The academy formed an “Ad Hoc Committee on the Large Space Telescope” headed by Spitzer, and its membership included the head of astronomy at NASA Headquarters, Nancy Grace



▲ Nancy Grace Roman (1925–2018), NASA's first Chief of Astronomy, photographed at Goddard Space Flight Center in 1972. (NASA)

Roman, who in the years to come became an important promoter of the space telescope. In 1969, the National Academy of Sciences approved the ad hoc committee's proposal for a 120-inch (3-meter) space telescope.¹⁷

OA and other science satellite programs in the 1960s and 1970s operated in the shadow of NASA's human space programs. While astronomy did not figure prominently in the human flights of the time, astronauts did operate a small telescope on the lunar surface during Apollo 16 and a solar observatory aboard the Skylab space station in 1973 and 1974. During the 1960s, NASA and its contractors carried out several studies into large space telescopes, usually assuming that astronauts would operate the telescope. After NASA spending for Apollo peaked in 1966, NASA's budget faced several years of reductions. This reflected U.S. government priorities that were shifting away from Cold War competition with the Soviet Union in space toward fighting the war in Vietnam and dealing with social problems at home. The administration of President Richard M. Nixon declined to approve NASA proposals for a space station in Earth orbit or more ambitious ideas for a return to the Moon or a human flight to Mars. Anxious to have a human space program to follow Apollo, NASA proposed a reusable winged vehicle called the Space Shuttle that could carry

astronauts and payloads to Earth orbit and back. By the time Nixon gave the go-ahead for the Shuttle Program in January 1972, NASA was studying space telescopes that could fly on board or be launched by the Shuttle.¹⁸

NASA began to gear up its work on the LST in 1970, establishing a committee to work on engineering the telescope and another to steer its scientific direction. During this time, NASA divided the spacecraft design into a Support Systems Module, an Optical Telescope Assembly (OTA), and the scientific instruments. In 1972, the Agency decided that Marshall Space Flight Center, whose work of creating and building the launch vehicles for Apollo was effectively done, would have responsibility for building the space telescope. Goddard, which had been home for most of NASA's space astronomy programs but was busy at the time with numerous space science programs, would also be involved in the program. The result was a troubled relationship between the two Centers. After protracted disputes over Goddard's role in the program, the Centers agreed in 1977 that Goddard would get responsibility for scientific instruments on the LST, and it would also be the place from which the telescope was controlled once it was placed in orbit. Some of the differences between the two Centers continued to affect the space telescope program until Marshall transferred program responsibility to Goddard as planned after Hubble was launched and commissioned.¹⁹

The LST could not begin in earnest until it won approval by the U.S. Congress. As NASA proceeded to design the telescope and its scientific research program, it did so in the knowledge that Congress would be very sensitive to its cost. As a result, cuts were made to the program, including the cancellation of a prototype version of the space telescope. A major lobbying effort by astronomers and others who were interested in the telescope was needed to stave off a congressional decision to eliminate funding for the LST program. Memorably, the promotional work led to the Large Space Telescope making an appearance in a Superman comic book in 1972.²⁰ Leading the lobbying effort in Congress were Spitzer; C. Robert O'Dell, the Space Telescope's Project Scientist at NASA from 1972 to 1982; and astrophysicist John N. Bahcall of the Institute for Advanced Study at Princeton, who went on to exercise a major influence on the space telescope science through its first 15 years of operation. LST supporters faced complications in 1972 when the high-level astronomy survey committee of the National Academy of Sciences issued its report setting out priority projects for astronomers. The report, *Astronomy and Astrophysics for the 1970s*, the second in a series of decadal surveys that continue to the present day, placed the LST among the second-tier priorities. Bahcall and Spitzer had to persuade Congress that the LST had a higher priority among astronomers than the decadal survey

report suggested, and in 1974 the lobbyists obtained a statement from the survey committee supporting the space telescope that bolstered their effort to win congressional support. Such a clear break from the recommendation of a decadal survey in astronomy has not occurred since that time.²¹

Smith wrote that “negotiation and compromise on the telescope’s design and the planned program to build it” were an integral part of assembling the coalitions that made HST politically feasible.²² As the U.S. Congress faced growing budget deficits and soaring inflation fueled in part by the energy crisis of the 1970s, it kept pressure on NASA to cut its own budgets. In 1974, NASA Administrator James C. Fletcher and even Spitzer, who had been spending a lot of time lobbying members of Congress, realized that the LST simply cost too much to gain approval from a majority in Congress.

That fall, NASA and a working group of scientists looked at a number of ways to reduce costs while minimizing the amount of harm to the LST’s science program, including reducing the size of the main mirror from 3 meters to 2.4 meters or even 1.8 meters. While there was pressure from Congress and within NASA to reduce the telescope to the smallest possible size, the working group concluded that support from astronomers for the LST would collapse if the LST’s aperture were reduced to 1.8 meters because many astronomers believed that such a telescope would be too small to meet its objectives. In the spring of 1975, NASA reduced the LST to a 2.4-meter aperture, but pressure to cut costs continued, especially when President Gerald R. Ford ordered government-wide budget cuts that fall in an attempt to fight the budget deficit. In October, NASA Deputy Administrator George M. Low decided that the program would be known simply as the Space Telescope in an effort to make it more politically palatable to Congress. But Fletcher, Low, and other leaders of NASA decided that the program would face serious problems getting through Congress if NASA included it in the fiscal year (FY) 1977 budget, which would be debated in 1976, an election year. Astronomers and contractors aggressively lobbied Congress to include the Space Telescope in the FY 1977 budget but fell short.

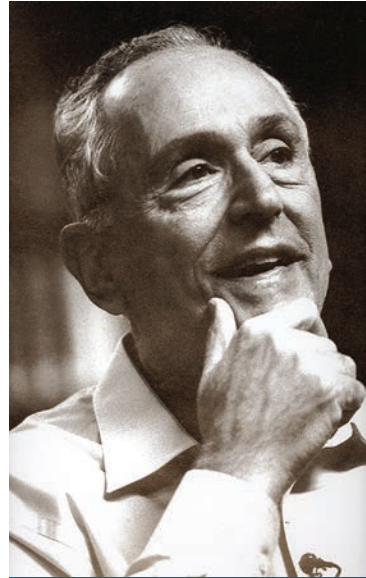

▲ Astrophysicist John N. Bahcall (1934–2005) championed the Hubble Space Telescope from its infancy to its ultimate scientific success. (STScI)

Continued lobbying and support from both the outgoing Ford administration and the incoming administration of President Jimmy Carter caused Congress to approve the Space Telescope for the FY 1978 budget year, which began on 1 October 1977.²³

BUILDING THE TELESCOPE

As NASA closed in on winning Congress's backing for the Space Telescope in 1977, it issued requests for proposals to build its Optical Telescope Assembly and Support Systems Module. In July, the Lockheed Missiles and Space Company won the competition for the Support Systems Module over Boeing and Martin Marietta, while the Perkin-Elmer Corporation was chosen for the OTA over a consortium of Eastman Kodak and Itek. Perkin-Elmer won because of the strength of its proposal for the telescope's Fine Guidance System, a major technical challenge and vital to correctly pointing the telescope at its targets. While Grumman had built the OAOs, both Lockheed and Perkin-Elmer had a

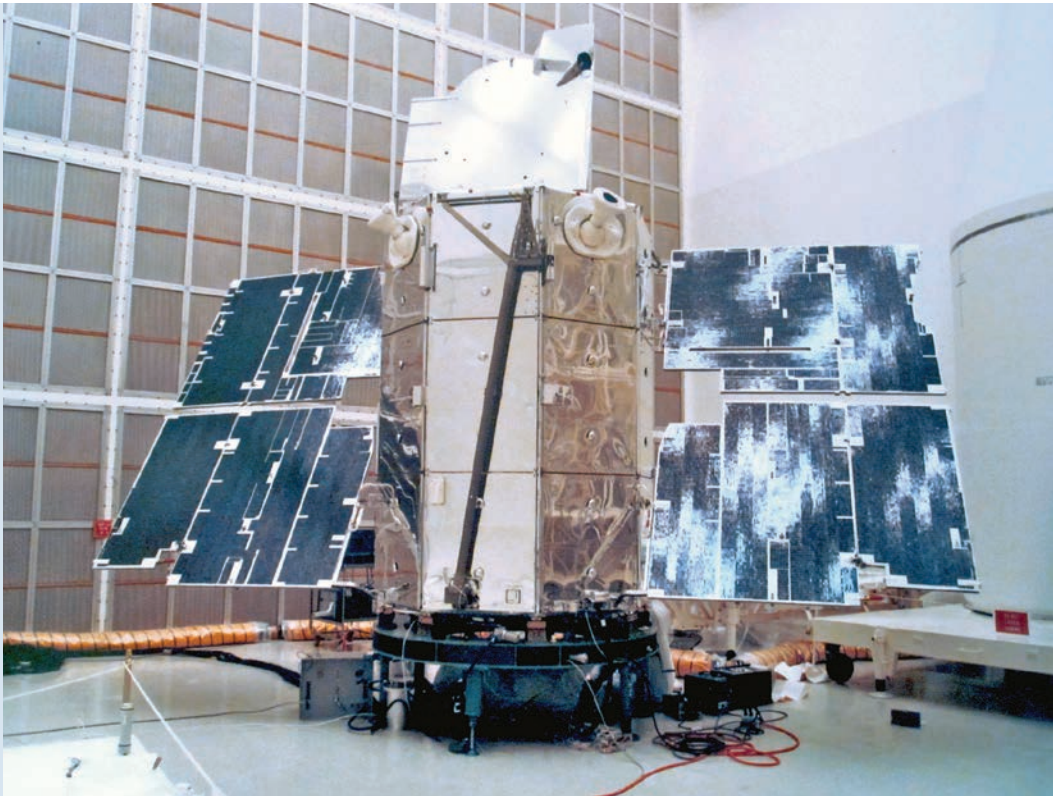

▲ Technicians in a clean room at NASA's Kennedy Space Center inspect the Orbiting Astronomical Observatory 2 before the mission's 7 December 1968 launch. (NASA)

long heritage of working together on highly classified reconnaissance satellites for U.S. military and intelligence agencies. In the case of Lockheed, Smith wrote, its “methods, resources, institutional memory, and expertise had been shaped almost entirely by its work on satellites for various national security purposes.”²⁴ Perkin-Elmer could be described in a similar way, although its background also included building astronomical telescopes. Because Perkin-Elmer and Lockheed were so heavily involved in national security programs, Marshall Space Flight Center was not permitted to exercise the same degree of oversight as it had traditionally done with contractors, an issue that was raised later when problems were found with HST’s main mirror.

Throughout HST’s lifetime, there has been speculation about its relationship to photoreconnaissance satellites, given the fact that both involved large optical systems and lead contractors that worked on national security programs. U.S. military and intelligence agencies began launching reconnaissance satellites in 1959 to provide information on America’s Cold War adversaries. Soon, these satellites were possessed by both sides in the Cold War and, in time, became the most important means of verifying treaties aimed at controlling the spread of nuclear weapons. NASA has routinely cooperated with the Department of Defense to protect classified intelligence programs and to benefit NASA programs by sharing technology. In the case of HST, this cooperation went beyond NASA contracting with firms building classified spacecraft to encompass DOD agencies assisting NASA with HST work, such as helping fabricate the spacecraft’s high-gain antenna booms and testing its gyros. HST was quite different from reconnaissance satellites whose designs have been declassified, notably the Hexagon KH-9 satellites that flew as recently as 1984. Hexagon and its predecessors were different sizes from HST, and they used photographic film returned to Earth, while HST relied on digital imaging. Information about Hexagon’s successors, which are widely believed to rely on digital imaging like HST, remains classified.²⁵ Speculation on HST’s links to reconnaissance satellites revived in 2012, when the National Reconnaissance Office donated two space telescope assemblies to NASA, which intends to use them for the upcoming Nancy Roman Space Telescope, formerly known as the Wide Field Infrared Survey Telescope (WFIRST). But the assemblies came from a canceled development program unrelated to the satellites that followed Hexagon.²⁶

Hubble’s relationship with classified military programs is only one part of the wider relationship between the Cold War and space astronomy in general and HST in particular. The Cold War had begun in the months following World War II, when the wartime alliance between the United States and the Soviet Union broke down over ideological differences and Soviet imposition

of communist regimes in Eastern Europe and support for communists elsewhere over the objections of the United States and its allies. The two sides in this conflict avoided direct war, but science and space exploration became two of the many arenas where the United States and the Soviet Union endeavored to outdo each other. Early Soviet successes in space inspired the United States to send astronauts to the Moon. After the Shuttle's design, including the dimensions of the payload bay, were changed to gain political support from the U.S. Air Force, NASA created the Space Shuttle in the 1970s, and some of its missions supported military space efforts. Historians such as Smith have argued that the U.S. government supported space astronomy in part to establish American leadership in space. As part of President Ronald Reagan's Strategic Defense Initiative in the 1980s, the U.S. military supported the development of technologies aimed at detecting Soviet missiles and warheads early in their flights, including the development of sensors that operated in certain wavelengths of ultraviolet radiation. This military research increased the availability of imagers for HST that operated in those ultraviolet wavelengths.²⁷

NASA and astronomers involved with the program had agreed that the Space Telescope would carry five scientific instruments mounted in the

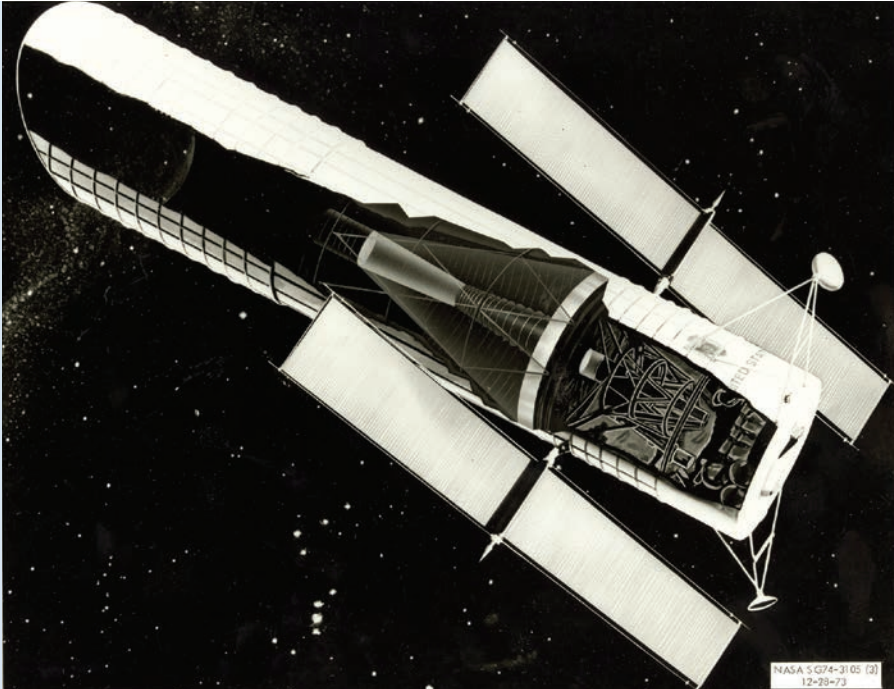

▲ Artist's conception of early Large Space Telescope design in 1973. (NASA: S G74-3105 [3])

Support Systems Module behind the main mirror. Early in the design process, NASA decided that with a 15-year planned lifetime for the telescope, all the scientific instruments should be designed so that they could be changed out on the ground in case of failure or to permit their replacement by later-generation instruments, but by the mid-1970s NASA became more interested in designing the instruments so they could be changed out in orbit.²⁸

When NASA issued a request for proposals (RFP) for scientific instruments and associated teams in March 1977, it identified a wide field camera and a faint object spectrograph as “particularly important.” That left at least two open spots for other instruments. The RFP reflected long discussions that had taken place among scientists preparing for the Space Telescope, including preliminary studies of ultraviolet spectrographs, high-resolution cameras, and photometers. Scientists formed teams headed by a Principal Investigator charged with designing an effective instrument and developing a scientific program for that instrument. Once selected, teams had to be prepared to work with contractors of their choice to build their instrument and work with NASA on related budgetary and technical issues.²⁹ Thirteen teams submitted proposals for the four open instruments, and after they were assessed by engineers, scientists, and a “synthesis panel,” NASA chose a team led by James A. Westphal of Caltech for the Wide Field Camera; a group led by Richard Harms of the University of California, San Diego, for the Faint Object Spectrograph; a team headed by John C. Brandt of Goddard for the High Resolution Spectrograph; and Robert C. Bless’s group from the University of Wisconsin-Madison for the High-Speed Photometer.³⁰

During the time when astronomers sought to win congressional support for the space telescope, politicians had demanded foreign involvement in the program to lower costs to U.S. taxpayers. European astronomers had suggested European participation in the LST program in 1973, and NASA began negotiations with the European Space Research Organization, which in 1975 became the European Space Agency (ESA). These talks resulted in an agreement in 1977 in which the ESA agreed to provide one of the Space Telescope’s scientific instruments and the solar arrays to power the space telescope, along with 15 full-time scientific staff involved in telescope operations, in return for a minimum 15 percent of observing time for European astronomers.³¹

The Europeans’ talks with NASA over their role in the Space Telescope program were lengthy, in part because of questions over what instrument the Europeans should build. As part of that process, NASA sent experts to Europe to verify that European industry was up to the job of building an instrument for the Space Telescope, which caused some resentment amongst some of the

Europeans. U.S. scientists and engineers had concerns about sharing technology new to the Space Telescope outside the United States and over ever-present security worries. Some American scientists also expressed concerns about putting the European instrument on board the Space Telescope without a competition. After NASA ruled out the idea of Europe contributing the high-priority Faint Object Spectrograph (FOS), the ESA and European scientists agreed with NASA on the Faint Object Camera (FOC) for the Space Telescope to image distant objects, but not before NASA demanded that the original design for the instrument be simplified. The FOC would be built by an industry team headed by Dornier in Germany and with ESA astronomer F. Duccio Macchetto as the Principal Investigator.³²

In addition to the FOC and the four instruments chosen through the RFP process for the Space Telescope, its three Fine Guidance Sensors could also act as its sixth scientific instrument. In this role, the sensors, which were built by Perkin-Elmer, would be used for astrometry, following the apparent motion of closer stars caused by Earth's motion around the Sun, as well as the motion of other stars and the changes in the brightness of variable stars. These measurements can in theory detect wobble in star movement that might suggest the presence of a planetary or stellar companion, measure stellar masses and the diameter of celestial objects, refine the positions and absolute magnitude of stars, and help refine measurements of the size of the universe.³³

With the contracts set, the program in late 1977 moved into building the telescope, with launch scheduled for 1983. At the time NASA negotiated the contracts with Lockheed and Perkin-Elmer and set budgets for the scientific instruments, there was still a substantial reserve left in the program's budget. Perkin-Elmer's costs began to rise beyond that within months. After Lockheed and Perkin-Elmer further increased their cost estimates as they ran into technical problems in 1979, NASA Headquarters asked for a cost review of the Space Telescope program. Program officials also began considering various economy measures, including delaying the launch, removing the aperture door from the telescope, and not putting all instruments on board at launch. Congress, always concerned about costs, began asking questions about the status of the program.³⁴

That year, NASA was also facing high-profile problems with the Space Shuttle that caused major cost overruns and delayed the first Shuttle flight until 1981. By late 1980, NASA had decided to move the Space Telescope launch back to late 1984. But given positive reports on the changes made to the program and strong support from scientists and NASA engineers, outgoing NASA Administrator Robert A. Frosch agreed in late 1980 to make more money

available for the Space Telescope. Within months of these decisions, program managers were faced with the first of another series of cost increases and schedule problems that came to a head in 1983. The program was still afflicted with technical challenges, funding problems, and management issues resulting from having two NASA Centers, Marshall and Goddard, and two main contractors, Lockheed and Perkin-Elmer, with leading roles in the program. These issues brought attention from the Space Telescope's critics in Congress and elsewhere. As a result, NASA ordered changes in the management of the program early in

Faint Object Camera (FOC)

Time on HST:

24 April 1990–7 March 2002

Contractor:

European Space Agency—
Dornier (Germany), Matra (France)

Principal Investigator:

Duccio Macchetto (STScI/ESA)

Weight: 320 kilograms
(700 pounds)

Axial Instrument

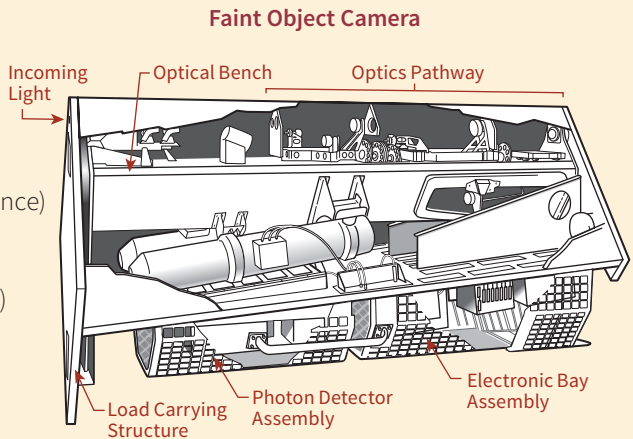

The FOC was one of the European Space Agency's main contributions to the HST program. It used the full spatial-resolution capabilities of HST.

It operated in far ultraviolet and visible wavelengths, about 1,200 to 7,000 Angstroms. It contained two cameras—one operating at a focal length of $f/48$ and another at $f/96$. The $f/48$ camera was equipped with two filter wheels and the $f/96$ with four filter wheels, which permitted many filter combinations.

Unlike other cameras on HST that use CCDs to collect data, the FOC used two photon-counting detectors, which were similar to a television camera. The FOC produced highly magnified but narrow field images; it could also be used for photometry; and it could also produce spectrograms.

1984, including a stronger role for NASA Headquarters in directing the completion of what became known in 1983 as the Edwin P. Hubble Space Telescope, a name that won unanimous support from a NASA selection committee. Despite the financial, technical and schedule problems, most of the telescope's components had been manufactured by 1984, but many issues lay ahead before HST could be launched.³⁵

In flight, the f/48 camera developed problems that limited its usefulness. When the COSTAR (Corrective Optics Space Telescope Axial Replacement) instrument was installed on Servicing Mission 1, correcting the spherical aberration to the FOC and other axial instruments in HST, it changed the focal ratio in the FOC's two cameras to f/75.5 and f/151.^a

During its lifetime, FOC was used to obtain close-ups of all classes of astronomical objects, from Pluto and its moons to stellar atmospheres and the cores of distant galaxies. FOC data resulted in several cosmological breakthroughs, including the first direct image of the surface of the red giant Betelgeuse, the first high-resolution image of the circumstellar ring from Supernova 1987A, the first detection of white dwarfs and stellar mass segregation in a globular cluster, and the first image of an “exposed” black hole. The FOC was retired from general use in late 1998, decommissioned in 1999, and returned to Earth by Servicing Mission 3B after nearly 12 years on orbit—the longest-serving of HST's original instruments.^b

At the time FOC was removed from HST, ESA project scientist for FOC Peter Jakobsen said: “Although the images obtained with the FOC have only rarely been as photogenic as the famous images from the Wide Field and Planetary Camera 2, FOC has in my opinion served the astronomical community well and brought home its share of scientific ‘firsts.’”^c

The FOC is now on display at the Dornier Museum in Friedrichshafen, Germany.

a European Space Agency, *A Long Look Back: ESA's Faint Object Camera* (Paris: ESA BR-67, 1990); Space Telescope Science Institute, *Faint Object Camera Instrument Handbook, Version 7.0* (Baltimore: STScI, June 1996).

b Andrew Wilson, *ESA Achievements: More Than 30 Years of Pioneering Space Activity*, 3rd Edition (Noordwijk, the Netherlands: European Space Agency, 2005), pp. 128–133.

c ESA, “European Faint Object Camera on Hubble Sets World Record—Celebrating the Successes of ESA's Sharp-Sighted Camera,” news release HEIC0204, 7 March 2002.

THE MAIN MIRROR

Shortly after work began on the telescope in October 1977, NASA commissioned the Corning glassworks in upstate New York to build two 2.4-meter mirror blanks for its main mirror, both made of low-expansion glass similar to space mirrors they had built for reconnaissance satellites. The two blanks were not made of solid glass; to save weight, they were made from many parts that were fused together somewhat like a sandwich: a facesheet at the top of the mirror that would be ground to a precision shape, a lightweight honeycomb core, a rear facesheet, an inner edgeband lining the hole in the center of the mirror where light would pass from the secondary mirror to the instruments below the main mirror, and the outer edgeband. As arranged by NASA, one of the blanks was sent to Perkin-Elmer to be precision-ground to the correct shape using an advanced computer-controlled grinding and polishing system and to have a special mount designed to simulate the microgravity environment of space. Corning sent the second mirror blank to Eastman Kodak for grinding and polishing using more traditional methods as a backup in case Perkin-Elmer ran into trouble with this essential task.³⁶

The 2,000-pound mirror blank destined to fly on HST arrived at the Perkin-Elmer plant in Wilton, Connecticut, in December 1978 for rough grinding. The blank already had a minor flaw, caused when components of the mirror had fused incorrectly, that could have led to uneven stresses on the mirror. Corning workers removed the fused glass, delaying the mirror's move to Perkin-Elmer. The defect further delayed grinding the mirror because Perkin-Elmer had further work to do to repair this problem. In the spring of 1979, an inspector found a cluster of fissures in the mirror shaped like a tiny teacup about a quarter of an inch (6 millimeters) across. Amid fears that the fissures could grow like a crack in a windshield, Perkin-Elmer halted grinding until its experts decided how to remove the affected area and then successfully completed the delicate task. The grinding of the mirror was supposed to take nine months; instead, it took twice as long, and the mirror wasn't moved over to Perkin-Elmer's plant in Danbury, Connecticut, for precision polishing until May 1980.³⁷

As discussed above, the Space Telescope program was under severe budgetary pressure at this time. Congress was intent on keeping costs down, and both Perkin-Elmer and Lockheed saw their costs skyrocket as the optimistic projections of their contracts became the reality of bent metal and ground glass. As two reporters from the *Hartford Courant* wrote later in a Pulitzer Prize-winning series on the mirror problems, "From the start, Perkin-Elmer was operating without any flexibility because the company had underbid the telescope contract," having bid \$70 million to do the job, \$35.5 million less than Kodak.³⁸ In

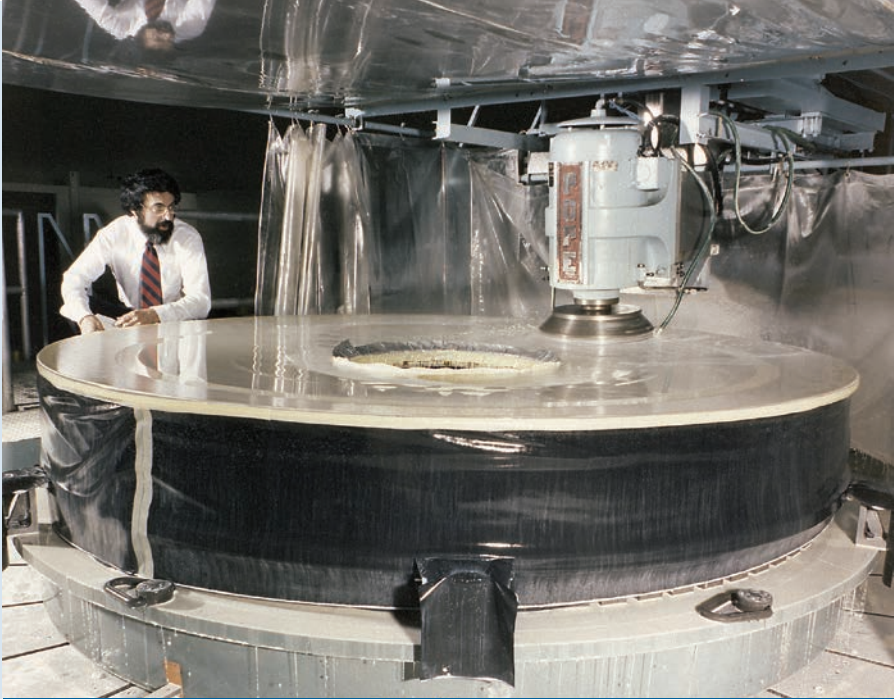

▲ The Hubble Space Telescope's primary mirror being ground at the Perkin-Elmer Corporation's large optics fabrication facility in Danbury, Connecticut, in 1979. (NASA: NIX MSFC-7995584)

the past, NASA had been able to make up funding shortfalls, but knowing the hostile reception that would greet cost increases in Congress, the Agency now turned down Perkin-Elmer's requests for more money. As the mirror polishing began in the summer of 1980, the space telescope program was undergoing a major financial crisis. The result was that corners were cut at Perkin-Elmer, including on testing the mirrors and building prototypes, and managers and workers were rushed to complete their work. As well, the company had recently expanded into the highly competitive field of microchips, and after initial success in that area, new managers were brought in with a focus on immediate pay-offs. These managers took a much bigger role in managing projects such as the HST mirror, while scientists, engineers, and other experts found themselves with diminished power.³⁹

Perkin-Elmer's work on the space telescope also included building the secondary mirror and three sophisticated Fine Guidance Sensors to point the telescope, and the latter task proved to be highly complex and expensive. NASA was also cutting spending on quality control at the time, and because Perkin-Elmer also built equipment for highly classified reconnaissance satellites, Department

of Defense officials persuaded NASA to limit the number of outsiders working within the Perkin-Elmer plants in the interests of maintaining security. In the case of Perkin-Elmer's work on the main mirror, only three NASA employees provided oversight of this critical component. Perkin-Elmer managers responsible for testing the mirror restricted quality assurance inspectors from other parts of the company and NASA from optical testing areas, and the managers refused to discuss their work on the mirror outside their group in the interests of preserving commercial secrets. Moreover, NASA and Perkin-Elmer quality assurance officials were not trained in optics.⁴⁰

In spite of these problems, Perkin-Elmer took many measures to ensure that the mirror was ground and polished to the precise shape required. A computer system directed the grinding and polishing of the mirror, which was placed on a bed of 138 titanium rods to simulate the microgravity environment of space. After each polishing run, the mirror was moved on rails to an adjacent room, where it would be placed in a test stand similar in size to the telescope itself. High above the mirror was an optical testing device about the size of a barrel called a reflective null corrector made of two mirrors and a lens. This null corrector

was specially designed and built for the Space Telescope's main mirror. Light from a laser was passed through the null corrector, reflected off the space telescope mirror back into the null corrector. The resulting pattern of black and white lines on the mirror, known as an interference pattern, was photographed through the null corrector and analyzed until the correct pattern was verified at the time the mirror was precisely ground and polished to its final shape. This system was so sensitive that the tests were run only

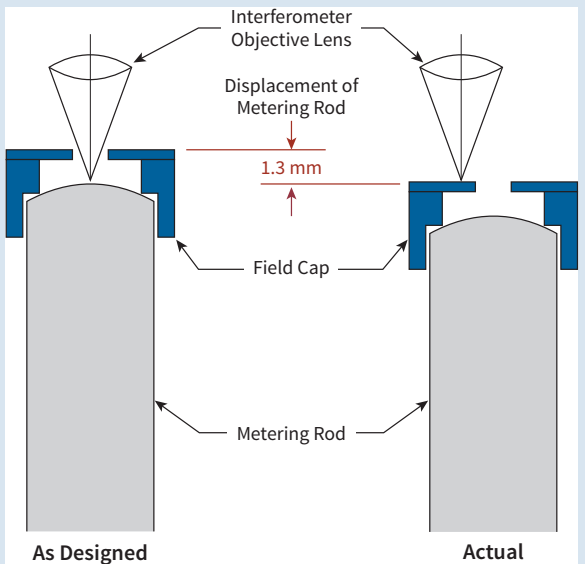

▲ This chart from the Allen Report depicts the defect in the null corrector used to test the main mirror for the Hubble Space Telescope. The chart shows how a lens inside the device was displaced, causing incorrect measurements that led to the mirror being ground precisely to the wrong shape. (Allen, Lew, et al., *The Hubble Space Telescope Optical Systems Failure Report* [Washington, DC: NASA TM-103443, 1990])

Report [Washington, DC: NASA TM-103443, 1990]

in the middle of the night when large trucks were not rumbling by on a nearby highway. The air conditioning in the building was turned off, and speed bumps on the road just outside were removed to reduce vibrations. Parts of the null corrector were made of invar, a material that does not expand or contract with temperature changes.⁴¹

But under the pressures of time and money, an error was introduced into the null corrector. This meant that a tiny but critical error was also introduced into the grinding and polishing of the Space Telescope's main mirror. The null corrector had been set up for a 60-inch (1.5-meter)-diameter test mirror and then readjusted for Space Telescope's real main mirror. An invar measuring rod whose length had been thoroughly and precisely tested to match the exact distance between the lens and the mirrors inside the null corrector was placed inside the apparatus for a measurement test that was done with a laser. When technicians tested the measurement rod, they found it was 1.3 millimeters or $\frac{1}{20}$ of an inch lower than it should be. They did not know that the laser was bouncing off a cap that protected the top of the rod. While the top of the rod had been polished to reflect the light from the laser, the cap had been painted so that it would not reflect light. But because some of the paint had worn off the cap before the crucial tests on the main mirror, the laser reflected off the cap rather than the rod. Technicians could not move the lens in the null corrector to equal what they thought was the correct distance from the mirrors. So instead of calling the machine shop or even the designer of the null corrector for help, they got three ordinary household washers, flattened them, placed them inside the \$1 million null corrector, and then moved the lens 1.3 millimeters lower than it should have been. The null corrector, with this error built into it, was then used to measure the shape of the Space Telescope's main mirror. Relying on the erroneous measurements from the null corrector, the 2.4-meter main mirror of the Space Telescope was precisely ground to the wrong shape, a fraction of a millimeter too flat at its edges. The one NASA inspector who was aware of the change made to the null corrector accepted assurances from Perkin-Elmer staff that the change would not be a problem.⁴²

In May 1981, the mirror was tested with another null corrector to determine its center of curvature. The interference patterns photographed with this instrument, known as a refractive null corrector, were quite different from the apparently perfect patterns seen using the main null corrector. Since the second null corrector was not as precise as the main null corrector, Perkin-Elmer personnel dismissed the findings, and the NASA personnel at the plant were not informed of these results. Higher-level Perkin-Elmer managers had passed up other opportunities to verify the shape of the mirror, including a proposal to

use a null corrector that its competitor Eastman Kodak had developed to test the backup mirror it had ground and polished. They also turned down a call by Perkin-Elmer's polishing team for a final review of the data at the time the mirror was coated with reflective aluminum in December 1981. The polishing team and a Perkin-Elmer technical audit called for a recertification of the main null corrector on several occasions, but no recertification took place. Indeed, a NASA Inspector General report found that a Perkin-Elmer document claimed that the null corrector had been recertified "when in fact the [null corrector] was never recertified." The report also noted that Perkin-Elmer testing team members had concerns about the mirror, but "reports and briefings to NASA failed to report any of these concerns."⁴³

Perkin-Elmer decided to block a final review, officially because there was no need, but unhappy Perkin-Elmer employees believed that the real reason was to

Fine Guidance Sensors (FGS)

Time on HST:

24 April 1990–Present

Contractors:

Perkin-Elmer and successors

Astrometry Principal Investigator:

Bill Jeffreys (University of Texas)

Weight: 218 kilograms (480 pounds)

Radial Instruments

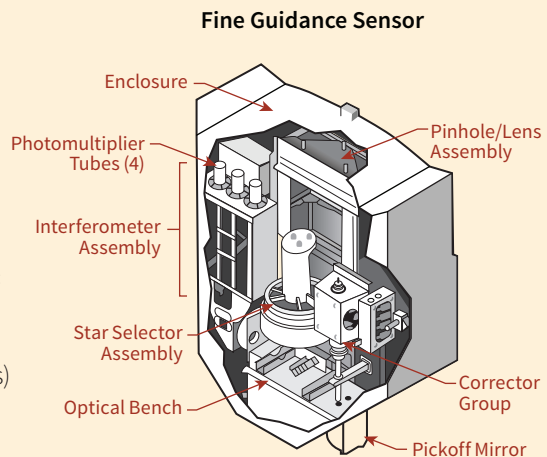

Three HST Fine Guidance Sensors (FGS) were launched aboard the telescope in 1990, and while their main function was to help guide HST and keep it locked on target, one was designated to act as a sixth science instrument for high-precision measurement of celestial object position, a science known as astrometry. These measurements detect wobble in star movement that would suggest the presence of a planetary or stellar companion, measure stellar masses and the diameter of celestial objects, refine the positions and absolute magnitude of stars, and help refine measurements of the size of the universe.^a

save money. Despite the nagging doubts about the mirror among the small group of Perkin-Elmer employees directly involved with testing it, everyone else at the contractor, NASA, and the ranks of scientists who had reviewed the preparation of the telescope thought the mirror was the correct shape. Perkin-Elmer's decision came as the launch of HST was delayed due to problems with the Shuttle. The defective mirror was integrated into the Optical Telescope Assembly in 1982 and was not tested or reviewed again in the eight years that ultimately remained before launch. Perkin-Elmer had a great deal of difficult work to do to complete the assembly and the Fine Guidance Sensors after the main mirror was installed, and ironically it received much more money to complete its work on HST after the main mirror was finished. Perkin-Elmer's continuing financial and business problems culminated in the December 1989 sale of its optical

Three FGS units and one imaging instrument occupy the four radial instrument bays just behind HST's main mirror and above the axial bays containing other HST instruments.

Four FGS units had been built, including an engineering test article. After two of the FGS units began to show mechanical wear problems prior to the second servicing mission in 1997, NASA decided to replace FGS1 on that mission with the refurbished engineering test unit, which became known as FGS1r. The Fine Guidance Sensors also suffered some slight degradation in performance from the spherical aberration in HST's main mirror, and while this could not be corrected for the original FGS units, the problem could be reduced with an articulating mirror assembly on the replacement unit in place of the original fixed mirror. In 1999, NASA designated FGS1r as the only FGS to be used for astrometric work on HST.

The original FGS1 was repaired and reinstalled on HST during Servicing Mission 3A in 1999 in place of FGS2. The newly installed FGS, which was called FGS2r, began showing problems in 2006, and it was replaced with the original FGS2, which had been refurbished, and once installed during Servicing Mission 4 in 2009, it has been known as FGS2r2.^b

a NASA, "Space Shuttle Mission STS-82 Press Kit," February 1997.

b STScI, *Fine Guidance Sensor Instrument Handbook for Cycle 24, Version 23* (Baltimore, MD: Space Telescope Science Institute, January 2016), p. 9.

division, which was responsible for the HST work, to the Hughes Aircraft Company. At that time, it was renamed Hughes Danbury Optical Systems.⁴⁴

PREPARING FOR LAUNCH

The series of schedule and budget problems in the early 1980s led to a shakeup of HST management early in 1984. The changes in the program encouraged Congress and NASA to free up more money for the program as telescope components came together. Its launch date by then was projected for the second half of 1986.⁴⁵ The Space Shuttle Program had finally entered its flight phase in April 1981 with the first launch of the Shuttle Columbia, and the pace of flights began to pick up as Challenger entered the fleet in 1983, followed by Discovery in 1984 and Atlantis in 1985.

The Space Shuttle, officially known as the Space Transportation System, was designed to provide routine, timely, and low-cost access to low-Earth orbit for both astronauts and payloads. Astronauts on board the orbiters carried out experiments in space, delivered robotic spacecraft into orbit, and maintained and repaired spacecraft for NASA and a variety of clients, including commercial firms and the Department of Defense. NASA also wanted the Shuttle to act as a delivery vehicle to a space station in orbit around Earth, but a space station program was not even announced until 1984. The Space Shuttle that emerged from its development process in the 1970s included a reusable orbiter that was boosted into orbit with the assistance of two reusable solid rocket boosters and a disposable external tank that fed the orbiters' engines as they carried the craft into orbit. After several days of operations in low-Earth orbit, the orbiter would reenter the atmosphere and, with the help of delta wings, glide to a landing much like an aircraft. Early in the Shuttle Program, it became clear that the Shuttle would not fly as frequently as had been hoped, and the cost of carrying astronauts and payloads into space remained stubbornly high.⁴⁶

In 1984, NASA made important decisions about the relationship of HST to the Shuttle. When the Agency had issued its Request for Proposals for the Space Telescope in 1977, it stated that astronauts from the Shuttle would service the telescope on orbit and that the telescope would be periodically returned to Earth and then re-orbited after refurbishment. A large number of components were being designed for on-orbit servicing, but as costs mounted, program management decided in 1980 to remove the capability for on-orbit servicing from a number of components, including power control units and the solar arrays. In 1984, NASA decided that returning HST to Earth would be unnecessarily risky due to the great expenses involved, which would be similar to the cost of building a new space telescope, along with concerns about

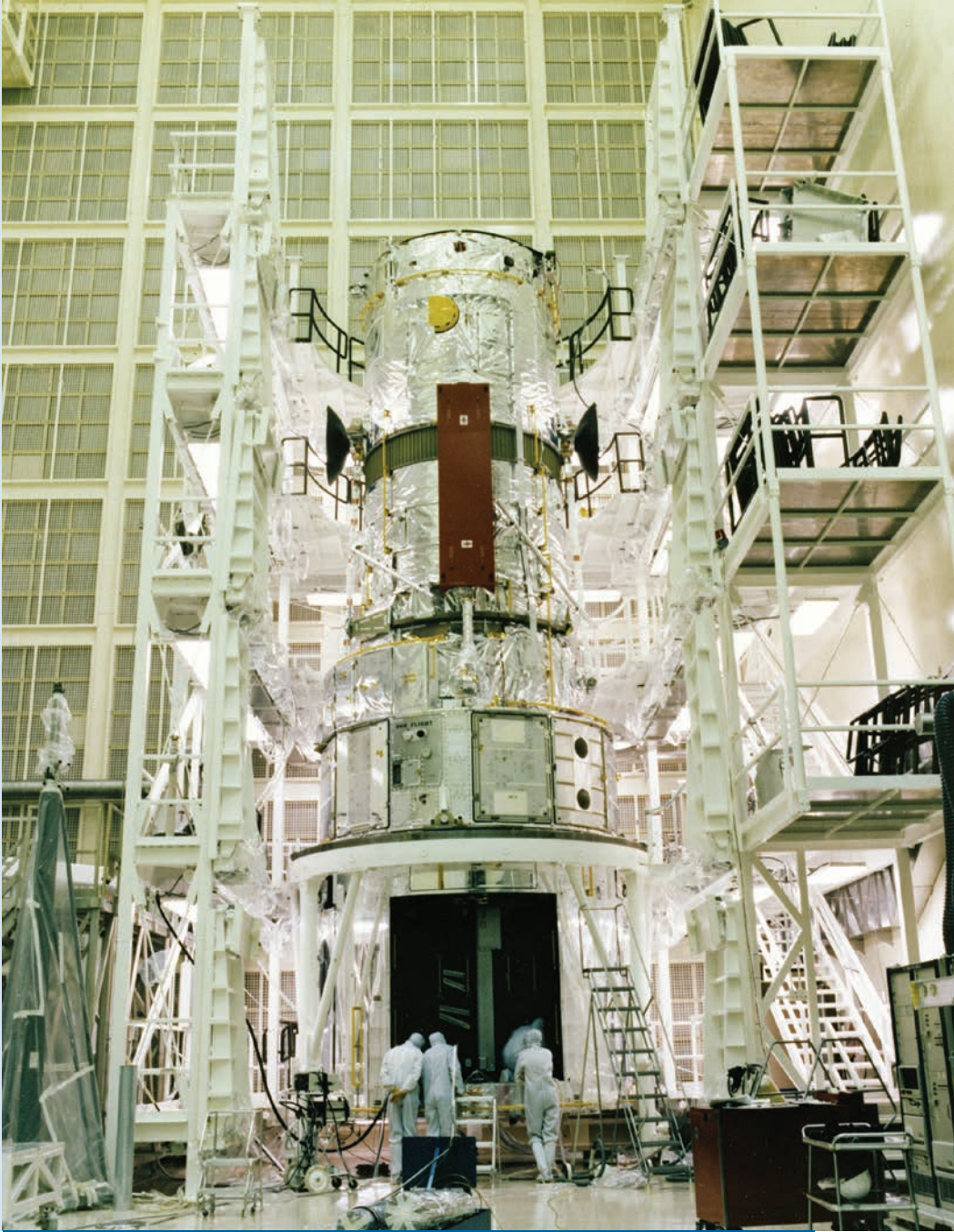

▲ This Hubble Space Telescope with multilayer insulation, high-gain antenna, and solar arrays in a clean room at the Lockheed Missiles and Space Company facility in Sunnyvale, California. (NASA: 8663388)

contamination of instruments back on Earth and mechanical stresses during reentry and launch. Moreover, if HST were returned to Earth for refurbishment, there was always the danger that it might be kept there to save money. By then, NASA knew that the cost of each Shuttle mission was much higher than had been originally hoped. Telescope scientist Robert Bless said refurbishment on Earth would also require extensive maintenance facilities and would take much longer than the originally projected six months. “When it became apparent that the cost of ground-return refurbishment would approach the cost of building a second telescope...the idea was abandoned.”⁴⁷ Instead, NASA

Wide Field/Planetary Camera (WF/PC)

Time on HST:

24 April 1990–6 December 1993

Contractor:

Jet Propulsion Laboratory

Principal Investigator:

James A. Westphal
(California Institute of Technology)

Weight: 268 kilograms
(590 pounds)

Radial Instrument

Wide Field and Planetary Camera

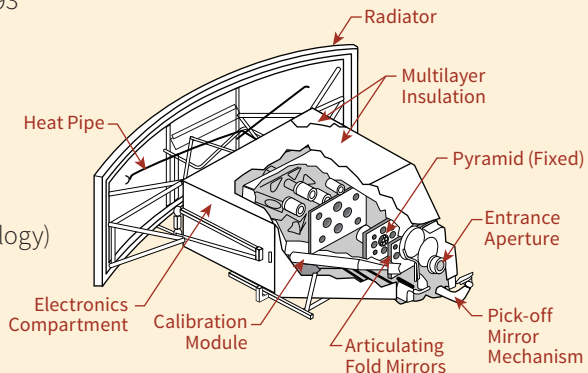

WF/PC was a pioneering instrument even before it got off the ground, since it involved an early use of charge-coupled devices in an astronomical instrument. When it was found that existing CCDs were not sensitive in ultraviolet wavelengths, Principal Investigator James Westphal tested CCDs coated with a substance called coronene in the Hale Telescope at Mount Palomar successfully to deal with the problem. Later on during the development of WF/PC, a puzzling problem called quantum efficiency hysteresis was found, in which the response of pixels in CCDs was affected by the previous image they had taken. Eventually, a light pipe was installed in HST's aperture door to flood and “decontaminate” the CCDs with ultraviolet light between images.^a

determined that the telescope would operate for up to 15 years in space with periodic visits by Shuttle astronauts. Edward J. Weiler, then project scientist for HST, argued that the ground repair option for the telescope and even for individual instruments “must be avoided as much as possible” because of its higher cost than space-based refurbishment, to ensure that the telescope operated “in the most cost effective manner possible.”⁴⁸ As a result of this decision, the program’s managers increased the number of what became known as Orbital Replacement Units to 50 and introduced other features to HST designed to facilitate EVA servicing.

WF/PC was in effect two cameras, the f/12.9 Wide Field Camera and the f/30 Planetary Camera, and each used four different CCDs for a total of eight CCDs. When light from HST’s mirrors entered WF/PC, it was directed to a pyramid that pointed the light at the four CCDs in each mode. The pyramid would rotate 45 degrees to move from wide field mode to planetary mode. Images were assembled or mosaicked from the four CCDs in each image mode. The camera operated from wavelengths of 1,150 angstroms in the ultraviolet to 11,000 angstroms in the near infrared. The CCDs were made by Texas Instruments and produced images with dimensions of 800 by 800 pixels. The instrument contained 12 filter wheels, each with four filters and a clear position.^b

The quality of WF/PC’s images was strongly affected by spherical aberration in HST’s main mirror. After HST’s scientific operations were updated to factor in the effects of spherical aberration, normal scientific operations began for WF/PC in 1991. Many of its best-known images were of brighter objects such as Mars, Jupiter, and Saturn inside the solar system. Some images of these and other objects were repaired using image deconvolution during computer processing. WF/PC was replaced by WFPC2 during Servicing Mission 1.

Much of WF/PC was recycled for use in WFC3, which was installed on HST in 2009. WF/PC’s optical channels have been put on display at the National Air and Space Museum in Washington, DC.

^a Smith, *The Space Telescope*, 250–251, 333–336.

^b Space Telescope Science Institute, *Wide Field—Planetary Camera Instrument Handbook, Version 3.0* (Baltimore, MD: STScl, April 1992).

By then, the first set of scientific instruments was being built for HST, all of them replaceable. The Wide Field/Planetary Camera (WF/PC), which was being built at the Jet Propulsion Laboratory in California, was considered particularly important because it would produce a major share of HST's scientific output and have a high profile with the public because of the images it would produce. It was also the most expensive and complex instrument. The charge-coupled devices (CCDs) inside WF/PC that would record the light from HST's distant targets were still a new technology that had only been created in 1969, and program managers and astronomers worked to deal with the shortcomings of early CCDs, including their limited size and wavelength sensitivity. Once WF/PC neared completion in 1983, NASA decided it would be wise to begin work on building a replacement wide field camera that could incorporate technological improvements as insurance against an early failure of the first instrument. The decision to get an early start on a replacement for HST's main camera turned out to be unexpectedly prescient.⁴⁹

HST reached a major manufacturing milestone in October 1984 when a Super Guppy aircraft moved the Optical Telescope Assembly from the Perkin-Elmer plant in Danbury, Connecticut, to Lockheed in Sunnyvale, California, where it was mated to the Support Systems Module the following February. Lockheed's assembly and test program began to fall behind because of Hubble's complex nature and Lockheed's expectations that testing would proceed in a similar manner to that of the military reconnaissance satellites that Lockheed usually built. When Defense Department spacecraft were being tested, Lockheed only had to deal with a small group of people, whereas HST involved many stakeholders, including Goddard, Marshall, and various scientific teams. As a one-of-a-kind spacecraft, HST had many unique features that required more thorough verification. Testing was further delayed because the tightly funded program had not allowed for prototype systems that were available in Lockheed's more generously financed national security satellite programs.⁵⁰ Charles J. Pellerin, Director of Astrophysics at NASA Headquarters during much of this time, came to believe that having two major contractors and two NASA Centers with major responsibility for the HST program, all of them with different cultures, added greatly to the cost and time needed to complete the telescope.⁵¹

ESTABLISHING AN INSTITUTE

When the Space Telescope program was established in 1977, NASA and outside astronomers had to come to an agreement on how the scientific work of the program would be managed. The two sides did not enjoy an easy relationship at the time. The strains between scientists and the space agency over the place

of science in NASA's flagship Apollo program were well known to the public even in 1970 as the Agency struggled with declining budgets and with scientists questioning NASA's long-range planning decisions.⁵² Astronomers were amongst those scientists who were suspicious of NASA, and as early as 1966, many of them urged that an outside body of experts direct science on the Space Telescope. Astronomers who worked for NASA at Goddard Space Flight Center expected to control the science program, but their hopes went against growing precedents in science in the United States. Starting in the 1950s, agencies of the U.S. government such as the National Science Foundation had begun to take a leading role in supporting new scientific facilities, including telescopes. A consortium of universities, the Association of Universities for Research in Astronomy (AURA), was created in 1957 to run the national observatory on Kitt Peak in Arizona.

With NASA's support, the National Academy of Sciences set up a committee in 1976 to examine how large space observatories should interact with their scientific users. The committee, which was headed by Donald F. Hornig, who had served as science advisor to President Lyndon B. Johnson in the 1960s, called for the creation of an independent science institute for the Space Telescope. During this time, Goddard opposed the institute, seeing it as limiting its own control over HST operations, while Marshall supported the concept. In 1978, NASA Administrator Frosch decided that NASA should authorize such an institute, and Noel W. Hinners, NASA's Associate Administrator for Space Science and a supporter of the institute concept, announced that NASA would work with a science institute but retain operational control of the telescope in orbit. The Hornig Committee was called back to review NASA's plans, and based on its recommendations, NASA put out a request for proposals for the Space Telescope Science Institute (STScI) in December 1979, with proposals due by the following March. Five university consortia sent proposals to a NASA Source Evaluation Board, and by September, only two proposals remained. AURA, which by then operated a number of other ground-based facilities in addition to Kitt Peak, proposed to set up the Institute on the Homewood Campus of Johns Hopkins University in Baltimore, Maryland. The other finalist was Associated Universities, Inc., which operated research facilities in several disciplines, including the National Radio Astronomy Observatory. It proposed to establish the Institute at Princeton University in New Jersey, the home of Lyman Spitzer. On 16 January 1981, shortly before leaving office, Frosch announced that the AURA proposal had won. The Institute would go to Baltimore, which was less than an hour's drive from Goddard. This meant that the Institute would be clearly

separate from Goddard, yet close enough to allow close working relationships with the HST Mission Operations Team in Greenbelt.⁵³ NASA Goddard and AURA signed a contract on 17 June 1981, establishing STScI at a ceremony attended by Center Director A. Thomas Young, acting STScI director Arthur D. Code, and Baltimore Mayor William Donald Schaefer, who predicted that Baltimore would become the “world capital of astronomy” over the two upcoming decades.⁵⁴ The original cost-plus-negotiated-management-fee contract took effect 1 April 1981 and continued through the first two years after the launch of HST, with provisions for renewals.⁵⁵

Not long after that, AURA made a controversial decision to select Riccardo Giacconi as STScI’s first director from a list of 60 candidates. Giacconi had moved to the United States from his native Italy in 1956 at age 25, and he began a groundbreaking career in x-ray astronomy that was later recognized with the 2002 Nobel Prize in Physics. He was also known for his organizational abilities. As an x-ray astronomer, Giacconi had once opposed the Large Space Telescope but years later changed his mind before applying to head the Institute. The new director was already known within NASA as a tenacious and often difficult negotiator, and his toughness was quickly put to the test, since many at NASA had a narrower concept of the Institute’s role in the Space Telescope program than did most scientists, including those at AURA. Despite its history of contracting out work, NASA was concerned about losing control of the already troubled and highly expensive program to this new entity that was not directly responsible—as NASA was—to higher government authorities and taxpayers. At that time, NASA saw the Institute’s role as simply serving astronomers who would use HST for their work, while Giacconi and other astronomers had a more expansive view, envisioning astronomers on staff at the Institute using the space telescope to do top-level science alongside astronomers from other institutions. Giacconi believed experience showed that “the best scientists gave the best service” to other scientists because they are more aware of the current state of knowledge in their field and because they were tied in better with the community of scientists with whom they would work with on HST observations.⁵⁶

STScI’s work in the 1980s was strongly affected by the fact that HST had been designed—and many components, notably the telescope’s main mirror, had been built—before the Institute opened its doors. During the 1980s, STScI built up its staff and supported the engineering work for HST ground systems, particularly those related to the scientific instruments. Institute staff members also created and tested much of the software and systems needed to meet the mission requirements for HST science operations.⁵⁷ During its first two years,

STScI operated out of temporary buildings at Johns Hopkins in Baltimore before moving to its permanent home on JHU's Homewood Campus, which was named the Steven P. Muller Building in 1990 after the outgoing president of JHU. Almost from the beginning and despite expansion work, space was at a premium in the building, and some Institute staff were located in neighboring buildings. In the 1980s, these tight confines were seen as a physical expression of the differences between NASA Headquarters and the Institute over the scope of STScI's role.⁵⁸

Early in the 1980s, scientists working on the first set of HST instruments reported difficult relations with the Space Telescope team at Goddard, which the new Center Director, Noel Hinners, and Goddard's new HST project manager, Frank Carr, worked to repair. Giacconi had tried and failed to get around NASA by taking the dispute between Goddard and STScI to President Reagan's Science Advisor, George A. Keyworth. In 1984, a committee of the Space Science Board of the National Academy of Sciences was formed to review the Institute's goals and objectives. While the committee's carefully worded report in 1985 noted that STScI spending was close to the upper limit of comparable institutions, it also said that neither the Hornig Committee that formally proposed the creation of STScI, nor NASA, nor AURA had "correctly anticipated the magnitude of the effort that would be required to carry out" STScI's functions. The report found "recent improvement" in the relationship between NASA and the Institute and urged the two sides to keep pursuing a better relationship.⁵⁹ James C. Welch, head of the Space Telescope Development Division at NASA Headquarters from 1983 to 1987, cast a critical eye on many aspects of the space telescope program, and, in 1986, prepared a report on STScI for the Subcommittee on Space Science and Applications of the U.S. House of Representatives. Welch's report suggested: "[g]iven STScI performance and management problems, alternative approaches should be explored. A Science Institute with a more restricted project role would cut costs, while assuring a visible, formalized science presence."⁶⁰ The report praised STScI's work in linking astronomers to the HST program but criticized its production of software systems for HST, particularly the Guide Star Selection System, which was running behind schedule and growing in scope, budget, and staff complement.⁶¹ While the report caused STScI to produce a 38-page refutation that noted that many systems changes had been requested by NASA,⁶² Robert Smith wrote that because "much of the passion in the debate on the Institute's size had subsided" at the time of the National Academy report the year before, NASA "quickly disowned" the Welch report.⁶³

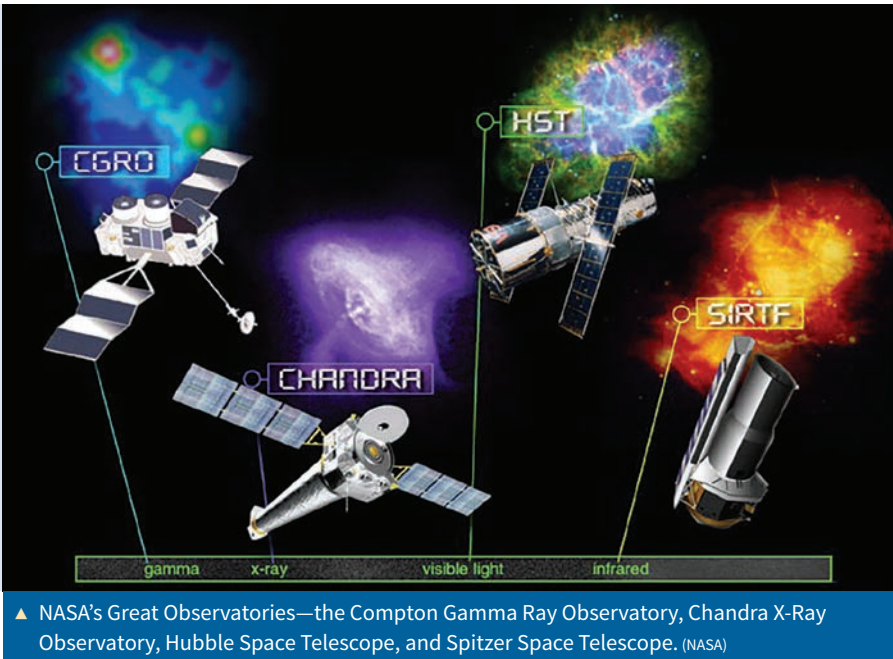

▲ NASA's Great Observatories—the Compton Gamma Ray Observatory, Chandra X-Ray Observatory, Hubble Space Telescope, and Spitzer Space Telescope. (NASA)

GREAT OBSERVATORIES

The early space observatories that came before HST had provided a taste to scientists of what could be found across the electromagnetic spectrum. Examining an object in just one narrow band of light told only part of the story. For example, collapsed stars near the end of their lives tend to emit most of their energy as x rays, while stars similar to the Sun emit more of their energy in visible light. As the first of a new generation of space observatories, HST covered visible wavelengths and, to a limited extent, ultraviolet and infrared light. As HST was awaiting launch in the 1980s, astronomers who concentrated on gamma rays were developing the Gamma Ray Observatory (GRO) for launch, following on earlier satellites such as NASA's High Energy Astrophysical Observatories (HEAO). Gamma rays are associated with energetic and often mysterious processes in the universe, but most gamma rays are absorbed by Earth's atmosphere. X-ray astronomers, whose number most famously included Giacconi, proposed their own larger-scale spacecraft, the Advanced X-ray Astrophysics Observatory (AXAF), to build on earlier observations of astronomical x-ray sources from satellites such as HEAO. Because of the wealth of objects that are visible in the infrared, astronomers were lobbying to create an infrared telescope mounted in the Shuttle payload bay that evolved into a free-flying space

observatory known as the Space Infrared Telescope Facility (SIRTF). These ideas and others were promoted in a National Research Council study setting out priorities for astrophysics in the 1980s.⁶⁴

Pellerin worked to promote these programs in 1984 to a Congress that was concentrating on tightening budgets to fight deficits. At the time, HST was well along in its development, the Gamma Ray Observatory was under way, and AXAF required approval from Congress to proceed. Pellerin thought it would make sense to sell AXAF in a package with SIRTF so that he could argue that they, along with HST and GRO, could allow astronomers to explore the whole spectrum from space. As Pellerin was directing the creation of a colorful brochure that explained the work of these space observatories in easy-to-understand terms, he discussed it with George B. Field, founding director of the Harvard-Smithsonian Center for Astrophysics. Field, who chaired the 1980s decadal survey of astronomers and astrophysicists that recommended these space observatories, suggested they be called the Great Observatories, and Pellerin ran with the idea as he worked with contractors and astronomers who would be lobbying Congress and the Reagan administration. Their lengthy lobbying campaign for AXAF led to program approval, and SIRTF later was endorsed as well.⁶⁵

The Great Observatories name stuck with the four spacecraft. GRO was launched in 1991 by the Shuttle Atlantis and was named after pioneering American physicist Arthur Holly Compton. It continued in low-Earth orbit until it was deliberately de-orbited on 4 June 2000, following the failure of one of its three gyroscopes. While it could have been refueled by the Space Shuttle, that option was never exercised. The Compton Gamma Ray Observatory has since been followed by other gamma-ray and high-energy observatory spacecraft. AXAF was renamed the Chandra X-ray Observatory after Indian American astrophysicist Subrahmanyan Chandrasekhar, who won the Nobel Prize for Physics in 1983. Chandra was launched into a highly elliptical orbit from the Shuttle Columbia on 23 July 1999. At this writing, it continues to operate after more than two decades of highly successful research. SIRTF was renamed the Spitzer Space Telescope in honor of astrophysicist Lyman Spitzer—who made the first formal proposal for what became HST—and was launched aboard a Delta II rocket from Cape Canaveral on 25 August 2003 into a heliocentric orbit trailing Earth. Spitzer ran out of helium coolant in 2009 and provided much data in what was known as the “Spitzer Warm Mission,” which ended in January 2020 when the spacecraft was turned off. Pellerin and Field’s idea of packaging the four spacecraft together as the Great Observatories has proven apt, as data from the four spacecraft have often been combined to provide a full scientific description of particular target objects and groups of objects.⁶⁶

CHALLENGER

As the Great Observatory Concept was winning approval in the mid-1980s, HST was nearing its planned Shuttle launch that would make it the first of this new class of space telescope. The full Shuttle fleet of four orbiters was operational by 1985, and some 14 flights were scheduled for 1986, including the deployment of HST from the Shuttle Atlantis on a flight in October. In 1985, NASA named an all-veteran crew of five astronauts headed by Chief Astronaut John W. Young to fly the HST deployment mission, then designated as STS-61J.⁶⁷ The crew included Bruce McCandless and Kathryn J. Sullivan, who both had spacewalking experience and would be ready to don their spacesuits and go into the Shuttle's payload bay to help deploy HST if necessary. In addition to preparing for their mission, they were mindful of the recent decision NASA had made to have Shuttle astronauts perform all servicing and repair work on HST. Sullivan wrote that "we had to do everything we could while Hubble was still on Earth to ensure that no future Hubble maintenance crew ever found themselves on a spacewalk with equipment that did not fit or work as needed." Working with experts from JSC, MSFC, and Lockheed, McCandless and Sullivan went over HST in its clean room looking for changes



▲ The crew of the Space Shuttle Challenger that perished during the launch of mission STS-51L on 28 January 1986. Crew members are (left to right, front row) Michael J. Smith, Francis R. (Dick) Scobee, and Ronald E. McNair; (back row) Ellison S. Onizuka, Sharon Christa McAuliffe, Gregory Jarvis, and Judith A. Resnik. (NASA: S85-44253)

that could make the telescope easier for astronauts to service and repair, and they also worked to improve the tools astronauts would need for their work with HST.⁶⁸

The Space Shuttle had proven to be much more complex and difficult to maintain than had been anticipated, and Shuttle launch delays became frequent events due to weather problems and mechanical issues. The 10th flight planned for 1985 was held up a month and instead flew in mid-January 1986. The first scheduled flight of the new year, a satellite deployment mission using the Shuttle Challenger, suffered postponements for a variety of reasons. Finally, on 28 January the 25th mission of the Shuttle program lifted off from Pad 39B at Kennedy Space Center, but 73 seconds later, the Shuttle stack broke apart, costing the lives of seven crew members, including the first schoolteacher to fly aboard the Shuttle, Christa McAuliffe. Investigators found that the disaster was caused by the failure of a rubber O-ring in one of the Shuttle's solid rocket boosters. NASA managers had ignored previous problems with O-rings, which were sensitive to the temperature at the launch site, and opted to launch Challenger on an unusually cold day. The disaster forced NASA to reconsider many aspects of the Shuttle program, and as a result, military, commercial, and other payloads were removed from the Shuttle launch manifest.⁶⁹

While NASA made changes to the Space Shuttle craft and procedures, there were no flights until 29 September 1988, when Discovery was launched on another satellite deployment mission. As its work of improving Shuttle safety and shuffling launch schedules continued, NASA postponed the launch of HST in a number of increments that continued until the launch date. On 17 March 1988, NASA named the crew for the HST deployment mission, STS-31, with Loren Shriver replacing Young as commander, for a launch on Discovery. Crew training formally began in July 1989.⁷⁰

While the public focused on the astronauts who lost their lives, the Challenger disaster also meant professional frustration for the astronomers who waited for their chance to use HST. The resulting delay increased costs for NASA because the team that maintained the telescope on the ground had to be kept together until the ultimate launch date. In early 1986, HST still faced important prelaunch work, notably a round of tests inside a vacuum chamber where it experienced the alternating heat and cold it would face in low-Earth orbit. The tests took place in May and June, and they showed that the telescope's power system needed more preparation before flight. HST managers also found that the system designed to protect HST against unexpected equipment problems and even the system that would be used to schedule observations were in need of improvement.

Although it was not immediately apparent, HST benefited greatly from the delay caused by the Challenger disaster, and the work done during that lengthy period of postponement may well have saved Hubble from a set of problems that could have curtailed its operations early in flight. Further development work was done on HST's computer software and scientific instruments. STScI completed the star catalog during this time. In addition, many of the smaller component parts were replaced and improved. People involved in controlling the telescope had more time to prepare for flight. Astronauts Sullivan and McCandless, NASA, and contractor experts took advantage of the time to propose more changes to HST and further improve tools to increase the possibilities for maintenance and repairs of HST on orbit.⁷¹

Perhaps most importantly, Hubble's two European-built solar arrays were redesigned and rebuilt. Starting with the first Shuttle flight in 1981, experts found surprising amounts of damage to Shuttle thermal blankets from atomic oxygen in low-Earth orbit. During the STS-41D Shuttle mission in 1984, material samples exposed to the environment of space showed that atomic oxygen damaged some materials, including silver and kapton, a plastic film widely used in spacecraft, that had been incorporated into the original solar arrays built for HST. New arrays were built to avoid what would have been a serious failure. The new solar arrays were also designed to provide more power to the telescope, and the output of the batteries was increased.⁷²

The loss of Challenger and its crew, followed by the revelations of poor management that were a primary cause of the disaster, put NASA under a shadow of suspicion. After sustaining the loss of many of its high-profile missions, including commercial payloads and national defense missions, the Space Shuttle Program returned to flight with the launch of Discovery in September 1988. In the fall of 1989, the Berlin Wall was brought down, along with many Eastern European communist regimes, marking the end of the Cold War that had helped give birth to both the Space Shuttle and HST. The Shuttle and its astronauts performed well in the nine missions that followed Challenger and preceded the launch of HST. Nonetheless, the importance of the Hubble Space Telescope to the reputation of the space agency had grown during its extended stay on Earth in the late 1980s as other payloads and missions were taken away from the Shuttle. As a result, the expectations that surrounded HST were larger than ever in April 1990, when the crew of Discovery launched with HST and placed it in space to finally begin its mission of discovery.

ENDNOTES

- 1 *NASASpaceflight.com* forums include Spitzer's comments on launch day at <https://forum.nasaspaceflight.com/index.php?topic=31995.300> (accessed 16 September 2017). The *STS-31 Mission Highlights Resource Tape* includes a television broadcast from Flight Day 5 of STS-31 where Kathryn Sullivan shows the eyepiece that the crew was able to borrow thanks to the Smithsonian Institution and the American Astronomical Society.
- 2 Galileo Galilei (1564–1642) was neither the first to build a telescope nor the only person to point a telescope at the skies at the time. The telescope emerged in Holland, and Thomas Harriot (1560–1621) recorded observations of the Moon and sunspots before Galileo but never published his observations. Galileo was the first to publish his telescopic observations of the Moon and Jupiter and its moons in his book *Starry Messenger* in 1610 just weeks after those observations, and of sunspots in a subsequent publication. For more on Galileo, see Michael Hoskin, ed., *The Cambridge Concise History of Astronomy* (Cambridge: Cambridge University Press, 1999), pp. 111–119, 125; and J. L. Heilbron, *Galileo* (Oxford: Oxford University Press, 2010), pp. 147–164. Albert Van Helden, *The Galileo Project*, <http://galileo.rice.edu>, 1995, accessed 23 March 2016, also contains information on Galileo and Harriot.
- 3 Michael Hoskin, *The Cambridge Concise History of Astronomy* (Cambridge: Cambridge University Press, 1999), pp. 224–227, 235–295; Klaus Brasch, “A Short History of Astrophotography: Part 1,” *Journal of the Royal Astronomical Society of Canada* 111, no. 2 (April 2017): 52–59.
- 4 Hoskin, *The Cambridge Concise History of Astronomy*, pp. 235–295; Smith, *The Space Telescope*, pp. 5–10. The size of reflecting telescopes is commonly recorded according to the aperture or diameter of the main mirror in the telescope.
- 5 NASA News, “Space Telescope Renamed as Edwin P. Hubble Space Telescope,” Release No. 83–155, NASA Headquarters, 21 October 1983.
- 6 Gale E. Christianson, *Edwin Hubble: Mariner of the Nebulae* (Bristol: Institute of Physics Publishing, 1995).
- 7 William L. Laurence, “Largest Telescope Dedicated to Man's Service at Palomar,” *New York Times* (4 June 1948): A1; William L. Laurence, “Palomar Observers Dazzled in First Use of 200-Inch Lens,” *New York Times* (5 June 1948): A1; W. K., “Time Out for the Giant Telescope,” *New York Times* (16 January 1949): E11; “‘Big Eye’ Is Ready,” *New York Times* (18 December 1949): E9; Ronald Florence, *The Perfect Machine: Building the Palomar Telescope* (New York: HarperCollins, 1994), pp. 386–398; Christianson, *Edwin Hubble*, pp. 273–359. Florence wrote on p. 416 that the problem afflicting HST's mirror was of a far more serious order than the final touches made to the Hale Telescope mirror.
- 8 There are numerous sources about the early history of space exploration, including Walter A. McDougall, *...the Heavens and The Earth: A Political History of the Space Age* (New York: Basic Books, Inc., 1985). For more on Goddard, see David A. Clary, *Rocket Man: Robert H. Goddard and the Birth of the Space Age* (New York: Hyperion, 2003). For more on the V-2, see Michael J. Neufeld, *The Rocket and the Reich: Peenemünde and the Coming of the Ballistic Missile Era* (Cambridge: Harvard University Press, 1995). Hermann

- Oberth, *The Rocket into Planetary Space* (English edition, Berlin: De Gruyter Oldenbourg, 2014), p. 71.
- 9 See David H. DeVorkin, *Science with A Vengeance: How the Military Created the US Space Sciences After World War II* (New York: Springer-Verlag, 1992).
 - 10 In 1948, Project RAND became the RAND Corporation. See Martin Collins, *Cold War Laboratory: RAND, the Air Force, and the American State, 1945–1950* (Washington, DC: Smithsonian Institution Press, 2002). Project RAND, *Preliminary Design of an Experimental World-Circling Spaceship* (Santa Monica, CA: Douglas Aircraft Company, Inc., 2 May 1946. Republished in 1996 by the RAND Corporation).
 - 11 Lyman Spitzer, Jr., “Astronomical Advantages of an Extra-Terrestrial Observatory,” Project RAND, 30 July 1946, in John M. Logsdon, general editor, with Amy Paige Snyder, Roger D. Launius, Stephen J. Garber, and Regan Anne Newport, *Exploring the Unknown: Selected Documents in the History of the U.S. Civil Space Program, Volume V, Exploring the Cosmos* (Washington, DC: NASA SP-2001-4407, 2001), pp. 546–552 (quotation on p. 551). See also Nancy Grace Roman, “Exploring the Universe: Space-Based Astronomy and Astrophysics,” *Exploring the Unknown, Volume V, Exploring the Cosmos*, pp. 501–543. The brilliant but curmudgeonly Swiss astronomer Fritz Zwicky wrote a journal article in 1947 that discussed the uses that rocket-borne telescopes could be put to in space. Fritz Zwicky, “Research with Rockets,” *Publications of the Astronomical Society of the Pacific* 59, no. 347 (April 1947): 64–73.
 - 12 Smith, *The Space Telescope*, pp. 46–48. For a biography of Spitzer, see George B. Field, “Lyman Spitzer, Jr. (1914–1997),” *Publications of the Astronomical Society of the Pacific* 110, no. 745 (March 1998): 215–222.
 - 13 McDougall’s . . . *the Heavens and The Earth* remains the best political history of the space race, although new information and new perspectives on this history have emerged since the end of the Cold War. See also Smith, *The Space Telescope*, pp. 27–39.
 - 14 Smith, *The Space Telescope*, pp. 58–64. Coalition quote from Robert W. Smith, p. 59.
 - 15 Smith, *The Space Telescope*, pp. 39–44; Mikulski Archive for Space Telescopes, “About Copernicus,” <http://archive.stsci.edu/copernicus/about.html> (accessed 15 December 2016).
 - 16 “Space Research: Directions for the Future—Report of a Study by the Space Science Board,” in *Exploring the Unknown, Volume V*, ed. Logsdon et al., pp. 579–585; Smith, *The Space Telescope*, 1965, pp. 48–53; John E. Naugle, *First Among Equals: The Selection of NASA Space Science Experiments* (Washington, DC: NASA SP-4215), p. 111; Lyman Spitzer, Jr., “History of the Space Telescope,” *Quarterly Journal of the Royal Astronomical Society* 20 (1979): 29–36.
 - 17 Smith, *The Space Telescope*, pp. 44–64. For more on Nancy Roman, see Nancy Grace Roman, “Nancy Roman: An Astronomer’s Life,” *Astronomy Beat* (Astronomical Society of the Pacific), no. 112, 11 June 2013).
 - 18 For more on the background of the Space Shuttle, see T. A. Heppenheimer, *The Space Shuttle Decision: NASA’s Search for a Reusable Space Vehicle* (Washington, DC: NASA SP-4221, 1999). See also Smith, *The Space Telescope*, pp. 58–82. Skylab was a short-term project built from Apollo hardware, and NASA hoped to win approval for a long-term

- space station for the Shuttle to visit. The space station did not win presidential or congressional approval until 1984. After being transformed into the International Space Station, its assembly in orbit finally began in 1998.
- 19 Roman, “Exploring the Universe,” p. 533; Smith, *The Space Telescope*, pp. 67–85, 228–232. See also Andrew J. Dunar and Stephen P. Waring, *Power to Explore: A History of Marshall Space Flight Center 1960–1990* (Washington, DC: National Aeronautics and Space Administration, 1999). Chapter twelve deals with the HST Program.
 - 20 Smith, *The Space Telescope*, pp. 120–123.
 - 21 Smith, *The Space Telescope*, pp. 131–134; Astronomy Survey Committee, *Astronomy and Astrophysics for the 1970s*, Vol. 1 (Washington, DC: National Academy of Sciences, 1972), pp. 98–101; Joseph K. Alexander, *Science Advice to NASA: Conflict, Consensus, Partnership, Leadership* (Washington, DC: NASA Monographs in Aerospace History, no. 57, 2017), pp. 109–112. See also Scott D. Tremaine, *John Norris Bahcall 1934–2005, A Biographical Memoir* (Washington, DC: National Academy of Sciences, 2011).
 - 22 Smith, *The Space Telescope*, p. 388.
 - 23 Ibid., pp. 116–186; see also Roman, “Exploring the Universe,” pp. 534–535; “James C. Fletcher, NASA Administrator, to James L. Mitchell, Office of Management and Budget,” and associated correspondence, in Logsdon et al., *Exploring the Unknown, Volume V*, pp. 644–652; and Mark Damohn, *Back Down to Earth: The Development of Space Policy for NASA During the Jimmy Carter Administration* (San Jose, CA: Authors Choice Press, 2001), pp. 115, 261.
 - 24 Smith, *The Space Telescope*, pp. 221–225; quote on 224.
 - 25 James E. David, *Spies and Shuttles: NASA’s Secret Relationships with the DoD and CIA* (Gainesville, FL: University Press of Florida, 2015), pp. 178–186; J. Kelly Beatty, “HST and the Military Edge,” *Sky & Telescope* (April 1985): p. 302; Robert W. Smith, “The Making of Space Astronomy: A Gift of the Cold War,” in *Earth-Bound to Satellite: Telescopes, Skills and Networks*, ed. A. D. Morrison-Low, Sven Dupre, Stephen Johnston, and Georgio Strano (Leiden, Netherlands: Brill, 2011), pp. 235–249; Smith, *The Space Telescope*, pp. 146–149.
 - 26 Warren Ferster, “Donated Space Telescopes Are Remnants of Failed NRO Program,” *Space News* (8 June 2012). While the two donated space telescopes have mirrors with the same aperture as HST’s main mirror, contractors different from the HST contractors built them starting in the late 1990s for a cancelled technology development program, so they are unrelated to HST.
 - 27 Smith, “Making of Space Astronomy.”
 - 28 Smith, *The Space Telescope*, pp. 104, 152–153.
 - 29 “Announcement of Opportunity for Space Telescope,” 18 March 1977 (Washington, DC: National Aeronautics and Space Administration); Smith, *The Space Telescope*, pp. 240–254.
 - 30 Smith, *The Space Telescope*, pp. 245–258; Peter J. Westwick, *Into the Black: JPL and the American Space Program 1976–2004* (New Haven, CT: Yale University Press, 2007), pp. 87–88. The High Resolution Spectrograph became known in 1987 as the Goddard High Resolution Spectrograph (GHRS).

- 31 Roman, "Exploring the Universe," pp. 533–534. See Smith, *The Space Telescope*, pp. 135–141; R. J. Laurance, "The History of the Hubble Space Telescope and ESA's Involvement," *ESA Bulletin* no. 61 (February 1990): 9–11. See "Memorandum of Understanding Between the European Space Agency and the United States National Aeronautics and Space Administration," *Exploring the Unknown, Volume V*, ed. Logsdon et al., pp. 670–681, 7 October 1977; and Dr. Rudolf Albrecht, oral history interview (OHI) by author, 9 November 2015.
- 32 See "MOU Between the ESA and NASA," *Exploring the Unknown, Volume V*, ed. Logsdon et al., pp. 670–681; and Smith, *The Space Telescope*, pp. 135–141, 245–246; Roger M. Bonnet and Vittorio Manno, *International Cooperation in Space: The Example of the European Space Agency* (Cambridge, MA: Harvard University Press, 1995), p. 76.
- 33 "Announcement of Opportunity for Space Telescope," *Exploring the Unknown, Volume V*, ed. Logsdon et al., pp. 664–670.
- 34 Smith, *The Space Telescope*, pp. 221–240.
- 35 Smith, *The Space Telescope*, pp. 259–313, 326; Dunar and Waring, *Power to Explore*, pp. 500–508; NASA News, "Space Telescope Renamed." In *Back Down to Earth*, Damohn discusses the budget problems afflicting the telescope up through 1980, and T. A. Heppenheimer, *The Development of the Space Shuttle 1972–1981* (Washington, DC: Smithsonian Institution Press, 2002) provides an overview of the Shuttle Program leading up to the first launch in 1981, including a discussion of HST's development, pp. 357–362. Charles J. Pellerin, oral history interview by author, 17 September 2015, pp. 5–7.
- 36 Smith, *The Space Telescope*, pp. 236–239; Lew Allen, et al., *The Hubble Space Telescope Optical Systems Failure Report*, chapter 3 (Washington, DC: NASA TM-103443, 1990).
- 37 Robert S. Capers and Eric Lipton, "Hubble Error: Time, Money and Millionths of an Inch," *Hartford Courant*, (31 March 1991): A1; Perkin-Elmer News Release, "Space Telescope Primary Mirror Delivered to Perkin-Elmer, Advance Copy," 10 November 1978, and other Perkin-Elmer Press Releases, Series 8, 38, "Perkin-Elmer Brochures, Press Releases, Articles, 1973–1984," Space Telescope Institute Working Files, Hubble Space Telescope Collection, 1962–1991, The Sheridan Libraries, Johns Hopkins University.
- 38 Capers and Lipton, "Hubble Error."
- 39 Eric Lipton and Robert S. Capers, "Corporate Changes, NASA Cutbacks Hit Project," *Hartford Courant* (1 April 1991); Allen et al., *HST Optical Systems Failure Report*, chap. 3.
- 40 Lipton and Capers, "Corporate Changes"; George A. Rodney, *Hubble Space Telescope: SRM&QA Observations and Lessons Learned* (Washington DC: NASA Office of Safety and Mission Quality, 1990); NASA Office of the Inspector General, "NASA OIG Report of Investigation: Hubble Space Telescope, Hughes Danbury Optical Systems Inc." (I-GO-90-259), 8 January 1991; Document released to <https://governmentattic.org> on 24 March 2009 in response to requests made under the Freedom of Information Act and posted on 21 August 2009 on <https://governmentattic.org>.
- 41 Robert S. Capers and Eric Lipton, "The Looking Glass: How a Flaw Reflects Cracks in Space Science," *Hartford Courant* (31 March and 1–3 April 1981); Smith, *The Space Telescope*, pp. 236–240; Allen et al., *HST Optical Systems Failure Report*, chap. 4.

- 42 Capers and Lipton, “The Looking Glass”; Allen et al., *HST Optical Systems Failure Report*; NASA Inspector General, “Report of Investigation, Hubble Space Telescope,” p. 5.
- 43 NASA Inspector General, “Report of Investigation, Hubble Space Telescope,” p. 12; Robert S. Capers and Eric Lipton, “Clues to a Flaw, and Missed Opportunities to Fix It,” *Hartford Courant* (2 April 1991). The top NASA engineer at Perkin-Elmer testified that while he was made aware of the changes made to the null corrector, he was not informed about some tests performed with other devices. He said Perkin-Elmer gave him explanations that suggested that the change to the null corrector and some other “discordant” test results were normal (see Inspector General Report, p. 6).
- 44 Capers and Lipton, “The Looking Glass”; Allen et al., *HST Optical Systems Failure Report*; NASA Inspector General, “Report of Investigation, Hubble Space Telescope,” Pellerin OHI, pp. 5, 11–12; Nolan Walborn, “Personal Recollections of Institute and Hubble Pre-History,” *Space Telescope Science Institute Newsletter*, 20, no. 1 (winter 2003): pp. 21–22; Christopher Burrows and Holland Ford, “Spherical Aberration: From Disaster to Glory,” comments at an HST 25th Anniversary panel, Johns Hopkins University, 23 April 2015. Ford said, “There were two telescope scientists, Bill Fastie in this (Johns Hopkins astronomy) department, and Dan Schroeder, they were very good people, but they could not get into Perkin-Elmer and see how the testing was being done. It was classified. It was behind the veil of national security.”
- 45 Smith, *The Space Telescope*, pp. 314–329.
- 46 A large number of books deal with the history of the Space Shuttle Program. The most comprehensive history of the entire program is Dennis R. Jenkins, *Space Shuttle: Developing an Icon*, 3 vols. (Forest Lake, MN: Specialty Press, 2016). David Hitt and Heather R. Smith, *Bold They Rise: The Space Shuttle Early Years, 1972–1986* (Lincoln: University of Nebraska Press, 2014) and Rick Houston, *Wheels Stop: The Tragedies and Triumphs of the Space Shuttle Program, 1986–2011* (Lincoln: University of Nebraska Press, 2013) cover Space Shuttle operations. A book that attempts to place the Shuttle Program in context is Valerie Neal, *Spaceflight in the Shuttle Era and Beyond: Redefining Humanity’s Purpose in Space* (New Haven, CT: Yale University Press, 2017).
- 47 Joe Rothenberg, oral history interview by author, 27 September 2016, pp. 6–7; Robert Bless, “Space Science: What’s Wrong at NASA,” in *Issues in NASA Program and Project Management*, ed. Francis T. Hoban (Washington, DC: NASA Scientific and Technical Information Program, 1991), pp. 35–42 (quote, p. 36); Joseph F. Shea, chair, *Report of the Task Force on the Hubble Space Telescope Servicing Mission* (Washington, DC: NASA, 21 May 1993), p. 3.
- 48 Edward J. Weiler, “Space Telescope Scientific Instruments Maintenance and Refurbishment,” memo, NASA Headquarters, 18 December 1983.
- 49 Weiler, “Space Telescope Instruments” memo; John Trauger, “Wide Field and Planetary Camera 2: ‘The Camera that Saved Hubble,’” unpublished manuscript, 1997; Smith, *The Space Telescope*, pp. 314–336; Shea, *Task Force Report*, 3.
- 50 Smith, *The Space Telescope*, pp. 360–367.
- 51 Pellerin OHI, pp. 5–7, 11. After Pellerin left NASA, his reflections about the causes of HST’s mirror problem and the work that led to its solution caused him to write a book

- and begin a new career as a management educator and consultant. See Charles J. Pellerin, *How NASA Builds Teams: Mission Critical Soft Skills for Scientists, Engineers and Project Teams* (Hoboken, NJ: John Wiley & Sons, 2009).
- 52 For an account of science in Apollo, see Donald A. Beattie, *Taking Science to the Moon: Lunar Experiments and the Apollo Program* (Baltimore, MD: The Johns Hopkins University Press, 2001).
 - 53 Smith, *The Space Telescope*, pp. 187–220; Roman, “Exploring the Universe,” p. 536; “NASA Ad Hoc Science Advisory Committee, ‘Report to the Administrator,’ 15 August 1966,” *Exploring the Unknown, Volume V*, pp. 586–592; “Institutional Arrangements for the Space Telescope: Report of a Study at Woods Hole, Massachusetts, July 19–30, 1976” (Washington, DC: National Academies of Science, 1976); Dunar & Waring, *Power to Explore*, pp. 485–488. For more on AURA, see Frank K. Edmondson, *AURA and Its US National Observatories* (Cambridge, U.K.: Cambridge University Press, 1997), and W. Patrick McCray, *Giant Telescopes: Astronomical Ambition and the Promise of Technology* (Cambridge, MA: Harvard University Press, 2004), pp. 38–42. In 1959, AURA had received funds to study the concept of an orbiting space telescope. See Smith, *The Space Telescope*, pp. 44–45.
 - 54 “Goddard, AURA Sign \$40 Million Contract for Space Telescope Institute,” *Goddard News* 28, no. 3, (6 July 1981). Operations contracts covering the HST Mission Operations Team at Goddard are discussed in chapter eight.
 - 55 NASA Office of Inspector General, “Space Telescope Science Institute, Goddard Space Flight Center, 19 June 1989.” Document released on 25 March 2010 in response to requests made under the Freedom of Information Act and posted on 21 August 2009 on <https://governmentattic.org>, p. 1.
 - 56 Smith, *The Space Telescope*, pp. 340–348; Riccardo Giacconi, *Secrets of the Hoary Deep: A Personal History of Modern Astronomy* (Baltimore, MD: Johns Hopkins University Press, 2008), pp. 220–221.
 - 57 NASA, *The Role of the STScI in the HST Project: Prepared for the Subcommittee on Space Science and Applications of the Committee on Science and Technology of the U.S. House of Representatives*, undated but issued in 1986, STScI Archive, Box 1.4, file, “Director’s Office re Welch Report,” JHU Library Special Collections, pp. 8, 12. HST’s main mirror had completed its manufacturing process early in 1981, before STScI began operations.
 - 58 Smith, *The Space Telescope*, pp. 337–348.
 - 59 Space Telescope Science Institute Task Group, Space Science Board, National Research Council, *Institutional Arrangements for the Space Telescope: A Mid-Term Review* (Washington, DC: National Academy Press, 1985), pp. 8, 9; Smith, *The Space Telescope*, pp. 350–358.
 - 60 NASA, *The Role of STScI*, p. 4. For more on the Welch report, see Smith, *The Space Telescope*, pp. 325–326, 389–390.
 - 61 NASA, *The Role of STScI*, pp. 17–23.
 - 62 Space Telescope Science Institute, *A Response to Report “The Role of the Space Telescope Science Institute in the Hubble Space Telescope Project,” prepared for the Space Telescope Institute Council*, 21 March 1986, p. 1.

- 63 STScl, *A Response*, p. 4; Smith, *The Space Telescope*, p. 352.
- 64 Roman, “Exploring the Universe,” pp. 532–542; Wallace Tucker and Karen Tucker, *Revealing the Universe: The Making of the Chandra X-Ray Observatory*, (Cambridge, MA: Harvard University Press, 2001), pp. 39–45; Astronomy Survey Committee, National Research Council, *Astronomy and Astrophysics for the 1980’s, Volume 1: Report of the Astronomy Survey Committee* (Washington, DC: National Academy of Sciences, 1982); Renee M. Rottner, *Making the Invisible Visible: A History of the Spitzer Infrared Telescope Facility (1971–2003)*, Monographs in Aerospace History, no. 47 (Washington, DC: NASA SP-2017-4547, 2017).
- 65 Pellerin OHI, pp. 19–20; Tucker and Tucker, *Revealing the Universe*, pp. 75–95; Astronomy Survey Committee, *Astronomy and Astrophysics for the 1980’s*. The entire text of the brochure Pellerin produced with the help of Martin Harwit, then of Cornell University, and contractor Valerie Neal to help sell the Great Observatories is reproduced in *Exploring the Unknown, Volume V, Exploring the Cosmos*, pp. 703–730. See also Martin Harwit, *In Search of the True Universe: The Tools, Shaping, and Cost of Cosmological Thought* (Cambridge: Cambridge University Press, 2013), pp. 230–255.
- 66 Roman, “Exploring the Universe,” pp. 532–542; Tucker and Tucker, *Revealing the Universe*. For Compton, see NASA, “Space Shuttle Mission STS-37 Press Kit,” April 1991, pp. 13–16. Rottner, *Making the Invisible Visible*, tells the story of Spitzer. NASA, “Mission News: NASA’s Spitzer Telescope Warms Up to New Career,” 6 May 2009, http://www.nasa.gov/mission_pages/spitzer/news/spitzer-20090506.html (accessed 4 April 2016); Paul Hertz, memorandum to Director, NASA Astrophysics Division, “NASA Response to the 2016 Senior Review for Astrophysics Operating Missions,” 9 June 2016.
- 67 On 19 September 1985, NASA announced the crew of STS-61J for the HST deployment mission using the Shuttle Atlantis, then scheduled for August 1986. Crew commander Young was a veteran of Gemini, Apollo, and Shuttle flights. The other members of the crew were those who eventually flew on STS-31. After the loss of Challenger, the STS-61J crew was formally stood down, although the former STS-61J crewmembers continued to prepare for HST deployment and servicing. Hawley, “How HST Influenced Shuttle Operations,” p. 386; Bolden OHI, pp. 1–3.
- 68 Sullivan, *Handprints on Hubble*, pp. 95–131, quote on p. 118; Ron Sheffield, oral history interview by author, 30 September 2016, part 1, pp. 2–4. Their work is discussed in more depth in chapter three.
- 69 See *Report of the Presidential Commission on the Space Shuttle Challenger Accident* (Washington, DC: June 1986). A number of books have been written about the Challenger disaster, including Allan J. McDonald and James R. Hansen, *Truth, Lies and O-Rings: Inside the Space Shuttle Challenger Disaster* (Gainesville, FL: University Press of Florida, 2009) and Diane Vaughn, *The Challenger Launch Decision: Risky Technology, Culture, and Deviance at NASA* (Chicago, IL: University of Chicago Press, 1996).
- 70 Bolden said that NASA considered flying the HST deployment mission as the Shuttle Return to Flight mission in 1988 before deciding to fly other missions first. “NASA’s 1986 Launch Schedule,” *Orlando Sentinel* (29 January 1986); Hawley, “How HST Influenced Shuttle Operations,” p. 386; Bolden OHI, pp. 1–3. See Riccardo Giacconi, *Annual Report to AURA Board of Directors: Space Telescope Science Institute* (STScl, Baltimore, MD,

March 1988), p. 1, for a discussion of STScI's concerns about repeated postponements of the HST deployment flight.

- 71 Smith, *The Space Telescope*, pp. 369–371; Sullivan, *Handprints on Hubble*, pp. 139–159.
- 72 European Space Agency, “How Hubble Got Its Wings,” http://www.esa.int/Our_Activities/Space_Engineering_Technology/How_Hubble_got_its_wings (accessed 25 January 2015); Steven A. Hawley, “Hubble Space Telescope Solar Array Concerns and Consequences for Servicing Mission 2,” *Journal of Spacecraft and Rockets* vol. 53, no. 1 (January–February 2016): 16; S. B. Mende and G. R. Swenson, “Space Vehicle Glow Measurements on STS 41-D,” *Journal of Spacecraft and Rockets* vol. 23, no. 3 (March–April 1986): 189–193; Theodore Gull, oral history interview by author, 12 May 2015; Pellerin OHI, pp. 12–16; Rothenberg OHI, pp. 11–13. See also B. W. Henson, “ESA’s First In-Orbit-Replaceable Solar Array,” *ESA Bulletin*, no. 61 (February 1990): 13–19.



CHAPTER TWO

Spherical Aberration

▲ This image of the Herbig-Haro Jet located in the Orion B molecular cloud complex is a composite of separate exposures acquired by the WFPC2 and WFC3/IR instruments in 2009 and 2014. (NASA/ESA/Hubble Heritage [STScI/AURA]/Hubble-Europe [ESA] Collaboration/D. Padgett [GSFC]/T. Megeath [University of Toledo]/B. Reipurth [University of Hawaii])

As the Hubble Space Telescope flew free for the first time after its release from the Shuttle Discovery's robotic arm on 25 April 1990, its first act was to seek out the Sun using its solar sensors. HST was already in radio contact with the ground, and it needed to know at all times where it was in relation to Earth's closest star. The telescope's optics could never be pointed at the Sun because direct exposure to the Sun's overpowering light and radiation could ruin them. The newly unfurled solar arrays, on the other hand, were positioned for maximum exposure to the Sun to power Hubble's systems. Once Discovery had moved away, Hubble began operations with an orbital verification program that NASA estimated would take 90 days to check out, calibrate, and prepare its systems for scientific work. Once these engineering verification checks were completed, scientists planned to carry out further tests of their own on the telescope and its five instruments before regular science operations would begin in the fall. In the words of a 1990 NASA press kit, "As an extremely complex, precise and sensitive spacecraft, the HST will require an extensive period of activation, adjustment, and checkout before it is turned over to the scientific community for their investigations." All new spacecraft require a commissioning process as the systems work at their full capacity for the first time in the environment of space, and as one of the largest and most complicated robotic spacecraft ever built, HST's commissioning period promised to be challenging.¹

Hubble's release into space also meant changes for many people on the ground. It marked the formal beginning of HST on-orbit mission operations for the HST mission operations team at NASA Goddard Space Flight Center

in Greenbelt, Maryland, and the beginning of the end of work for those at Marshall Space Flight Center in Huntsville, Alabama, who built the telescope. The Goddard team, which included engineers, software developers, schedulers, and controllers, had prepared for years to take control of HST. Marshall experts worked in Greenbelt and Huntsville to oversee Hubble's Orbital Verification Program during HST's first days on orbit. Scientists and engineers based at the Space Telescope Science Institute in Baltimore, Maryland, worked in coordination with the Goddard science and engineering teams to observe and assess the first tests of the telescope's systems and instruments. Once HST's systems were verified, Marshall's HST program responsibilities would end, and Goddard and STScI engineering and scientific teams were due to begin Hubble's science verification program.²

HST BASICS

The heart of the giant spacecraft that is HST is a 2.4-meter (94-inch) f/24 Ritchey-Chrétien Cassegrain reflecting telescope with a focal length of 57.6 meters (189 feet).³ Light entering the telescope passes to the concave main mirror and is reflected back to the convex secondary mirror near the top of the telescope. The 0.3-meter (12-inch) secondary mirror in turn reflects the light a second time through a hole in the center of the main mirror and down into the five instruments located below. The telescope structure between the main and secondary mirrors is lined with baffles to reduce stray light entering off its main axis. Arrayed around the main mirror and lower part of the telescope tube are equipment bays containing electronic systems related to communications, power, data management, and pointing control of the spacecraft. Many HST systems and instruments were designed for astronauts from visiting Space Shuttles to service or replace them. Located on the exterior of the spacecraft are an aperture door at the top end of the telescope, attachment points for the two solar arrays and two high-gain antennas, and two grapple fixtures for the Shuttle arm to engage on in the forward shell of the telescope. The aft shroud surrounding the equipment below the main mirror carries access doors and handholds to support spacewalking astronauts, and on the aft bulkhead there are pins to attach HST to a flight-support structure in the Shuttle payload bay, plus attachments for electrical connectors to the Shuttle. Since Servicing Mission 4 in 2009, HST has been equipped with the Soft Capture and Rendezvous System on its aft bulkhead to enable a future spacecraft to rendezvous and dock with Hubble for disposal into a controlled reentry or a higher orbit.⁴

Six gyroscopes on board HST precisely measure rates of motion when the telescope changes direction. Normally, three of the six gyroscopes are used for

HUBBLE SPACE TELESCOPE CONFIGURATION

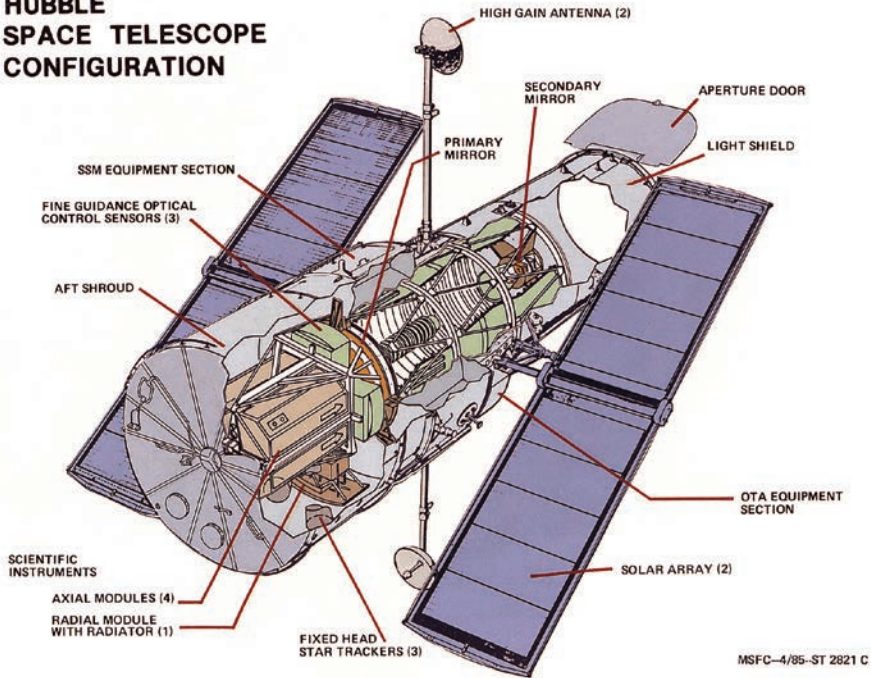

▲ Cutaway drawing from 1985 of the Hubble Space Telescope with instruments. At the time of launch, HST's instruments included the Wide Field/Planetary Camera (WF/PC) as a radial instrument and four axial instruments: the Faint Object Camera (FOC), Goddard High Resolution Spectrograph (GHRS), Faint Object Spectrograph (FOS), and High Speed Photometer (HSP). (NASA: MSFC-4/85-ST 2821 C)

pointing control, and the other working gyroscopes are spare units. In response to input from the gyroscopes, HST's computer commands four reaction or momentum wheels to transfer their momentum to the spacecraft and turn it to any direction. HST is equipped with three Fine Guidance Sensors that lock onto two guide stars located in the periphery of HST's field of view. Using its specially created catalog of stars, Hubble is able to point at and hold its targets steady with a degree of accuracy greater than any previous spacecraft or any telescope on the ground.⁵

HST carries five dedicated scientific instruments on board at any given time, and the original five launched as part of the spacecraft on board Discovery in April 1990 included two imaging instruments, the Wide Field and Planetary Camera and the Faint Object Camera; two spectrographs, the Goddard High Resolution Spectrograph and the Faint Object Spectrograph; and the High

Speed Photometer (HSP). Three Fine Guidance Sensors on board also act as a sixth instrument. Because only two of the three sensors are needed to lock onto a target, the third sensor can make very fine measurements of the location of stars in its field of view. The astrometric measurements the sensors make are so accurate that the effect of Hubble's movement around the Sun as it orbits Earth, known as parallax, can refine measurements of the distances to closer stars. Improving the accuracy of estimated distances to nearby stars is a crucial step to making better measurements of the size of the universe.⁶

The Wide Field and Planetary Camera, also known as WF/PC, operated in two modes—wide field mode and planetary. The wide field mode covered a wide field by HST standards, but not those of observatories on Earth—it would take 100 shots in this mode to photograph the full Moon. In its planetary mode, the camera could photograph objects about the apparent size of the planets in our solar system. WF/PC could image those near objects as well as distant galaxies in wavelengths from the far ultraviolet to the near infrared. This instrument was developed at the Jet Propulsion Laboratory in Pasadena,

Faint Object Spectrograph (FOS)

Time on HST:

24 April 1990–13 February 1997

Contractor:

Martin Marietta Corporation

Principal Investigators:

Richard Harms (University of California, San Diego)

Weight: 306 kilograms

(675 pounds)

Axial Instrument

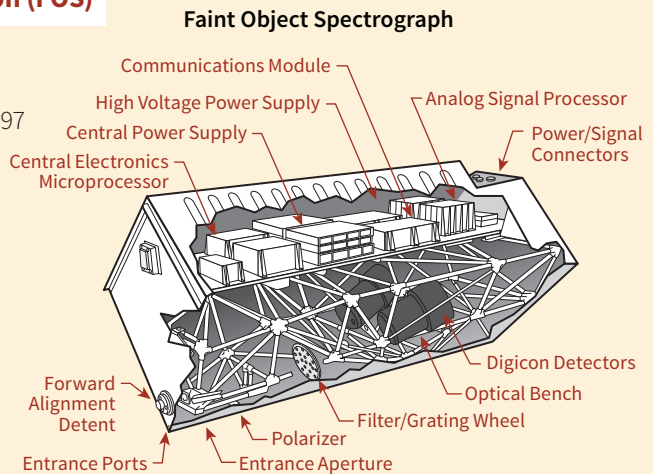

FOS was designed to measure the distribution of energy versus wavelength coming from faint objects, many of which are distant objects, to determine their makeup, physical characteristics, and dynamics. It operated in ultraviolet, visible, and

California, which had experience building similar instruments for spacecraft that have explored the solar system.⁷

The European Space Agency built the Faint Object Camera (FOC), along with the solar arrays, as one of its contributions to the HST program. FOC's images covered even smaller areas than the planetary mode of WF/PC, but it could image very faint objects and operate at very high resolution. This powerful camera was designed to help determine the size of the universe and see objects that were impossible to view from the ground.

In a similar vein, the Faint Object Spectrograph (FOS) was designed to use spectroscopy to learn about the properties of extremely faint objects in the visible and ultraviolet parts of the spectrum. Built by the aerospace giant Martin Marietta, FOS was able to isolate individual objects from others that were nearby. The Goddard High Resolution Spectrograph (GHRS) worked in a similar fashion to FOS, but it enabled higher spectral resolution and better separation of data of different colors, and it worked exclusively in ultraviolet wavelengths. This instrument, built by Ball Aerospace of Boulder, Colorado,

near-infrared wavelengths and could study fainter objects than the GHRS, which flew on HST at the same time.

It had two digicon detectors with independent optical paths, a blue detector that was sensitive to light from 1,150 to 5,400 angstroms and a red detector that operated on wavelengths from 1,620 to 8,500 angstroms. It operated in low-resolution and high-resolution modes. The installation of COSTAR (Corrective Optics Space Telescope Axial Replacement) in late 1993 corrected the effects of spherical aberration on FOS, and it continued operation until it was removed from HST during Servicing Mission 2.^a

FOS was used for many observations, some together with GHRS, of various objects. Among other things, spectrograms from FOS could measure the chemical composition and motion of interstellar clouds and of individual parts of nebulae and galaxies.^b

FOS is now on display at the National Air and Space Museum in Washington, DC.

^a STScI, *Faint Object Spectrograph Instrument Handbook, Version 6.0* (Baltimore: STScI, June 1995).

^b ESA, "Greater Accuracy Deepens Understanding—Hubble's Faint Object Spectrograph Re-calibrated," news release, 11 September 2001.

was designed to produce highly detailed spectrograms containing information about the chemical composition, motions, and physical structures of objects from distant quasars to nearby solar system planets.

Hubble's fifth instrument, the High Speed Photometer, was a highly precise light meter that measured the brightness of the objects in space, along with the slightest variations in that brightness. Built by the University of Wisconsin Space Astronomy Laboratory, the HSP looked for light variations resulting from objects revolving around each other, or an object losing light and matter to a nearby black hole.⁸

The infrastructure required for HST consists of more than its instruments and systems and goes beyond the control center at Goddard. Data from Hubble's instruments and systems pass through several steps between the telescope in space and the scientists on the ground. HST transmits its data first to one of three Tracking and Data Relay Satellites (TDRS) located in geosynchronous

Goddard High Resolution Spectrograph (GHRS)

Time on HST:

24 April 1990–13 February 1997

Contractor:

Ball Aerospace

Principal Investigators:

John C. Brandt and
Sara Heap
(NASA Goddard)

Weight: 315 kilograms

(695 pounds)

Axial Instrument

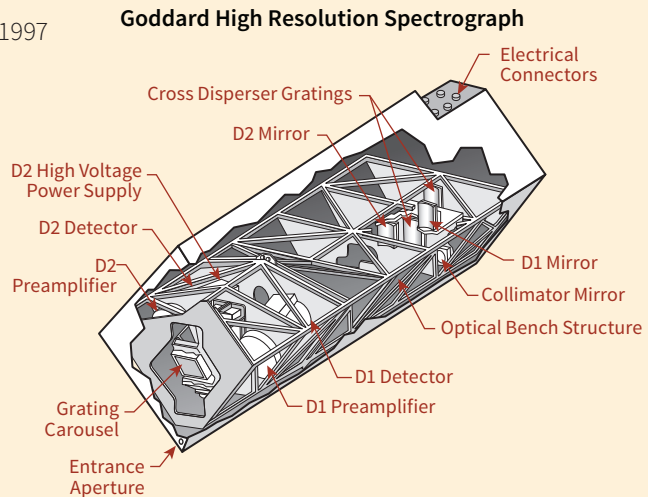

The Goddard High Resolution Spectrograph was equipped with a large and a small science aperture and two digicon detectors. It operated between 1,150 and 3,200 angstroms, providing access to ultraviolet wavelengths not available from Earth, and its location above the atmosphere permitted the use of high-resolution spectra

orbits, one over the Pacific Ocean, a second over the Atlantic, and the third acting as a spare. The TDRS satellites then beam the data down to a ground terminal at White Sands, New Mexico, where the data enter NASA's communications network headquartered at Goddard. Other NASA spacecraft, including Space Shuttles, use the TDRS system, along with military satellites and weather satellites. Since the first components of the International Space Station were launched in 1998, it also has communicated through TDRS satellites. Once received on Earth, the HST data are then transferred to Goddard, home of the Space Telescope Operations Control Center (STOCC), which monitors the health of HST and controls its systems. After initial receipt at Goddard, scientific data are transferred to the STScI, which also organizes, processes, and archives the telescope's observations. Data were also archived at ESA's HST European Coordinating Facility at Garching, Germany, until 2012, when the ESA moved the European HST archive to the European Space Astronomy

that are useful to study faint targets close to brighter stars and distinguish individual stars in crowded fields.^a

While GHRS was not as strongly affected by HST's spherical aberration as imaging instruments, the power supply for one side of the instrument suffered from problems that were repaired during Servicing Mission 1 in 1993. GHRS failed and shut down a week before Servicing Mission 2, when it was due to be replaced by another instrument.

During its lifetime, GHRS performed studies of the interstellar medium, stellar winds, the abundance of various elements and the evolution of stars, quasars and galaxies, and studies of the atmospheres of bodies in our solar system.^b

Much of GHRS was recycled for use in the Cosmic Origins Spectrograph, which was installed on HST in 2009.

a STScI, *Instrument Handbook for the Goddard High Resolution Spectrograph (GHRS, Version 5.0* (Baltimore, MD: STScI, May 1994).

b J. C. Brandt et al., "The Goddard High Resolution Spectrograph: Instrument, Goals, and Science Results," *Publications of the Astronomical Society of the Pacific* 106, no. 702 (August 1994): 890–908. See also John C. Brandt, Thomas B. Ake III, and Carolyn Collins Peterson, eds., *The Scientific Impact of the Goddard High Resolution Spectrograph* (San Francisco, Astronomical Society of the Pacific Conference Series, Volume 143, 1998).

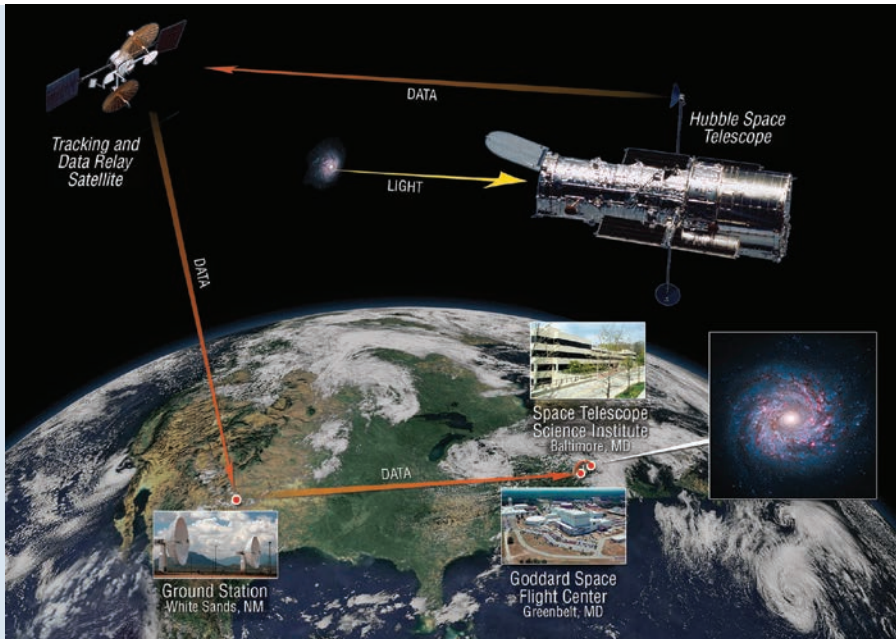

▲ This image illustrates the path that science and engineering information from the Hubble Space Telescope takes from space to Earth. After Hubble observes a target, it transmits the information to Tracking and Data Relay Satellites and the White Sands Complex, which relay the signals to NASA's Goddard Space Flight Center. Once checked for quality, the data are sent on to the Space Telescope Science Institute for processing, storage, and distribution. (NASA/STScI)

Centre (ESAC) in Villanueva de la Cañada, Spain. HST data are also archived at the Canadian Astronomy Data Centre in Victoria, BC, Canada. Scientists can obtain Hubble data from any of the three locations.⁹

SAFE MODES

After it deployed Hubble, Discovery remained within 80 kilometers (50 miles) of HST for two days while HST completed early systems tests and, most importantly, opened its aperture door and exposed the telescope's optics to space for the first time. Even before the aperture door opened, controllers got a taste of problems that were in store. In order to prevent the spacecraft from harming itself or going out of control in emergency situations, HST was designed to go into varying degrees of what were called safe modes, from simply stopping motion to closing the aperture door and restricting operations and communications with the ground. Hubble went into safe mode for the first time on the second day after deployment when the topside high-gain antenna required too much force

to rotate and track a TDRS satellite. Using both photos of the antenna and a Tinkertoy model that replicated the antenna movements, Goddard engineers found that the problem was caused by a counterweight striking a cable. They solved the problem by imposing a small limit on where the antenna could move to avoid the cable. Controllers opened HST's aperture door for the first time while they were still dealing with this safing event, and unexpected shaking caused by the aperture door opening caused Hubble to move into a deeper safe mode. Despite this latest safe mode, which was quickly explained, the successful aperture door opening allowed NASA to permit the Shuttle to move away from HST and prepare for its return home.¹⁰

In the early days of HST orbital verification, controllers noticed that the Fine Guidance Sensors on the telescope would lose their lock whenever HST passed between sunlight and darkness—something that happens twice in every 95-minute orbit that Hubble makes around Earth. These oscillations, or jitters, were especially strong when Hubble passed from night to day, and they could last as long as 10 minutes, eating into limited observing time. The reason for these jitters was not immediately clear, other than the fact that it was related to the major temperature changes that accompanied moving in and out of Earth's shadow. Soon expansion and contraction of the telescope body was eliminated as a possible cause, and the problem was traced to the two sets of solar panels attached to HST. The panels, built by British Aerospace with support from other European contractors, each covered 2.4 meters (8 feet) by 12.2 meters (40 feet) and together contained 48,800 individual solar cells that generated 4,100 watts of electricity to run the telescope and charge its batteries. The jitters were related to the design of the bi-stems—stainless steel rods that pulled the panels out when the Shuttle deployed HST in orbit and then held the panels rigid during flight. The bi-stems would bend in sunlight because one side was in light and was therefore hot, and the other in darkness and cold. Although the solar arrays shook much more than the telescope did, the telescope's extremely fine tolerances meant that the oscillations were enough to create problems for HST's guidance sensors and instruments. Tension also built up inside the bi-stems that held the arrays, and it caused the arrays to move at unexpected times, further disrupting operations. While engineers and controllers were able to develop control measures to reduce jitter, ESA and British Aerospace began to design and build a new set of solar arrays to be deployed on the first Shuttle servicing mission. The new arrays included mechanical changes and bellows to cover the booms and reduce the temperature changes in each orbit.¹¹

Once the aperture door was open and Discovery and its crew safely returned to Earth two days later on 29 April, the next event the media and the public

awaited from HST was its first image. When HST was launched, NASA had promised a photograph of an open star cluster named NGC 3532 in the constellation of Carina a week after launch.¹² But the safing events and the jitter problem set back the acquisition of the first image. By 15 May, the delays had attracted the attention of the popular *Late Night with David Letterman* show on the NBC television network, which included a “Top 10 Hubble Telescope Excuses” list. The excuses included “The guy at Sears promised it would work fine,” and “Ran out of quarters,” concluding with the top excuse: A “race of super-evolved galactic beings are screwing with us.”¹³

FIRST LIGHT

As late as Hubble’s originally scheduled launch date in 1990, NASA had no plan to release HST images to the public during the telescope’s commissioning process. This followed a disagreement between officials at the Space Telescope Science Institute who wanted to release images early to the public, and astronomers with observing time on HST who were concerned about possible problems with images being released before they were analyzed, a dispute that will be outlined in chapter four. HST managers had decided to have Hubble take its first image of the colorful NGC 3532 star cluster. Since all HST images are monochrome, which means that color images must be assembled from monochrome images shot using different filters, STScI Senior Scientist Eric Chaisson requested before the launch that HST shoot a series of images of the cluster that would allow a first image to be released in color. His request was turned down, which meant that the “First Light” image would be an unspectacular monochrome picture—which NASA was not planning to release. Astronomers’ expectations for the first images were not high because the optics of new telescopes need to be adjusted before use, particularly in a telescope subject to the forces of a launch into orbit. Al Boggess, the HST Project Scientist at Goddard, later recalled his response when a NASA official asked him what astronomers usually do with a first image from a ground-based telescope: “Well, it gets thrown in the wastebasket. It isn’t worth looking at.” Hubble was also the first space telescope that generated images in optical wavelengths, departing from previous space telescopes that produced spectroscopic observations or operated in different wavelengths. The relations between astronomers who worked with images and those who used spectra were not always friendly, Boggess explained.¹⁴

But NASA’s plans for the first image changed at a press briefing at Kennedy Space Center the day before HST’s scheduled launch on 10 April, when journalists repeatedly asked NASA Associate Administrator Lennard Fisk about the

Agency's plans to release the first photos from Hubble. Fisk was unprepared for the questions from reporters who brought up the easy availability of images from the two Voyager spacecraft during their planetary encounters between 1979 and 1989, just months earlier. After a long and awkward exchange with the media, he reluctantly agreed in an offhand fashion to having reporters present when HST transmitted its first image to ground controllers.¹⁵

Finally, on Sunday, 20 May, at 11:12 a.m. EDT, WF/PC imaged a small portion of NGC 3532 as planned for 1 second, and then 2 minutes later for 30 seconds. When the images were beamed to Earth that afternoon, journalists were permitted to witness and record their transmission to the Goddard control center while many scientists examined the images at STScI without the media present. Based on the released portion of the 30-second exposure centered on the 8.2-magnitude star HD96755, the *New York Times* reported that the telescope had “gazed with unexpected clarity” at its target. Newspaper accounts of the event contained exultant quotes from Hubble scientists, who were not expecting spectacular photos from the cluster, especially so early in HST's commissioning process. “The images were at least twice, if not three times, better than expected,” Jim Westphal, Principal Investigator for WF/PC, told the *New York Times*. NASA released a portion of the first image alongside a similar image taken from a 2.54-meter (100-inch) telescope at the Las Campanas Observatory in Chile, and the stars in the HST image were clearly sharper, a fact that was noted in the accompanying press release from STScI and NASA.¹⁶

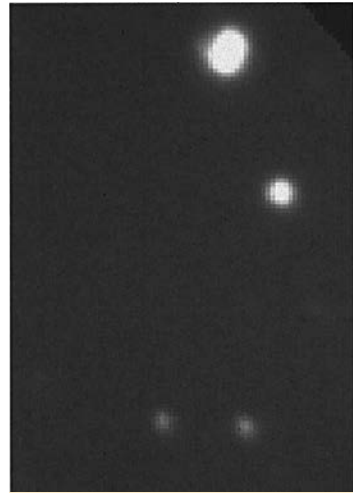

Ground-based image, Las Campanas Observatory, Carnegie Institute of Washington



Hubble Space Telescope Wide Field/Planetary Camera

▲ On 20 May 1990, the “First Light” image from HST's Wide Field/Planetary Camera was released, showing stars inside the open cluster NGC 3532 in the constellation Carina (bottom). The same stars are shown in an image obtained with a 100-inch telescope in Las Campanas, Chile (top).

(NASA/STScI: STScI Release 90-4)

GROWING CONCERNS

Despite the jubilation about the first images, a few scientists suspected immediately that something was not right with Hubble. When Charles Pellerin, NASA's Director of Astrophysics, expressed concern about the image, a colleague reminded him that the secondary mirror was not in its proper place in anticipation of the telescope structure changing shape in reaction to the vacuum and temperatures of space. Roger Lynds, a member of the WF/PC team, said in a meeting the next day that something was wrong, and the problem could be spherical aberration. That meant that the light coming off HST's main or secondary mirror was not meeting at the focus point as designed but was coming to a focus at different points. But with many possible and more benign explanations for the problems with the images—such as the solar panel jitter issue or the need to make final adjustments to the mirrors inside the telescope—this explanation was not widely believed at the time, and Lynds did not assert his belief. The existence of such a major flaw, especially in the highly touted main mirror of the telescope, was hard to believe, and many of the scientists and engineers working on HST had more trouble believing it than others. Christopher Burrows, a British physicist who was a member of the ESA staff at STScI with responsibility for optics on HST, worked with various computer models to try to determine what was wrong with the images. Burrows at first thought the problem was coma, which could be cured by adjusting the main mirror using actuators located behind it, and this idea became popular among the people trying to solve the problem.¹⁷

Lynds and other members of the WF/PC team would play key roles in bringing HST engineers and scientists to understanding the true nature of the problem with Hubble's images. The WF/PC team members were not burdened like other people involved in the work of verifying HST's systems by strong institutional bonds with Goddard, Marshall, or contractors such as Lockheed and Hughes Danbury, formerly Perkin-Elmer, or by their chains of command, according to Tod Lauer, an astronomer on the WF/PC team. "We were just a bunch of scientists from different places, and we had no institutional loyalties, so we could just sort of wander around and pick at whatever we wanted to pick at." In the early days of HST operations, the WF/PC team based itself in offices at Bowie State University, a few minutes away from NASA Goddard, but they were often at Goddard working with other scientists.¹⁸

A leading member of the WF/PC team and one of America's top astronomers, Sandra M. Faber of Lick Observatory in California, was away doing other work when the first images came in. When Faber returned late in the month to join the WF/PC team at Bowie State, she began a journal of the days that followed.

She heard many rumors and questions about the images. WF/PC images taken on 31 May of the NGC 188 star cluster in the constellation Cepheus exhibited what she later called a “kidney-shaped asymmetry” in the individual stars. By 4 June, Faber saw vignetting in an image, where light falls off gradually rather than sharply, and the next day another image showed the odd asymmetry Faber had noticed in the NGC 188 images. She began working with Burrows to develop a means of explaining the image problems, which some ascribed to roughness on the main mirror. Their analysis of the new images continued slowly, but by 8 June, Faber had recorded that the gravity of the problems with the telescope was finally sinking in amongst the engineers and astronomers working at Goddard and STScI. As Faber left that day for 10 days of work elsewhere in the country, she wrote Westphal with details about the situation. She had found “large amounts of spherical aberration and some defocus” in the images, and she added that while she had not shared her concerns on this point with anyone other than Lynds and her graduate student, Jon Holtzman, “it keeps me awake at night.”¹⁹ Before Faber left, STScI Hubble Operations Scientist Rodger Doxsey had ordered crucial imagery designed to diagnose the telescope’s problems. When Faber returned, many of her colleagues still hoped that adjustments to the telescope optics would solve the problem. Actuators on the main mirror could adjust its shape slightly, and the secondary mirror could also be moved, but moving the secondary mirror did not solve the problem.²⁰

On 17 June, HST was aimed again at NGC 188, and this time the ESA’s Faint Object Camera obtained its first images. The disquieting light patterns noted in the WF/PC images were also seen in the FOC images, which ruled out a defect in WF/PC as the cause of the image problems. The growing concerns about HST remained unknown to the public as ESA released an FOC image five days later alongside a much poorer image of the same stars shot from Earth with a release

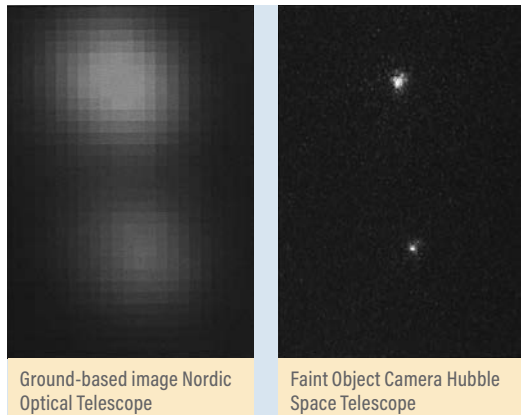

Ground-based image Nordic Optical Telescope

Faint Object Camera Hubble Space Telescope

▲ This “First Light” image from the European Space Agency’s Faint Object Camera on HST was released on 22 June 1990, showing stars inside the open cluster NGC 188 in the constellation Cepheus (left). It was released alongside an image of the same stars taken with a 101-inch Nordic Optical Telescope in the Canary Islands (right). (NASA/ESA/STScI: STScI Release 90-6)

suggesting that HST's problems were being solved. Some astronomers criticized the released FOC image as being manipulated.²¹ On 19 June, Bob Basedow of the mirror's contractor, Hughes Danbury, said at a meeting that if an analysis presented to the meeting by Burrows was correct, which he did not accept, the actuators on the main mirror would not be able to correct the problem. To both Burrows and Faber, Basedow's statement meant that HST's image problem was beyond the easy solution that everyone was hoping for. "This is the moment we find out that we are doomed to failure!" Faber recorded in her notebook.²²

Later that day, a long-duration HST exposure showed Faber and her colleagues the effects of diffraction. Late that week, WF/PC produced a series of long-exposure images with the secondary mirror moved to various positions well out of focus that were useful for understanding the characteristics of the optics. By Saturday, 23 June, Faber found that one of the new images had a hollow center with a ring—it was called the smoke ring image, and as Faber recalled, "anybody with half a brain is getting to the fact that we have spherical aberration." Her conclusion was reinforced when Holtzman produced computer simulations of HST's spherical aberration. That day at Goddard, Faber showed experts from NASA, STScI, and Hughes Danbury how the smoke ring image suffered from the effects of spherical aberration. "You could hear a pin drop," she recalled of the reaction from the Hughes Danbury engineers, who



▲ Sandra Faber and Tod Lauer of the WF/PC team photographed in 1988 during a test of the Wide Field/Planetary Camera at the Jet Propulsion Laboratory in Pasadena, California.

(Tod Lauer)

had strongly rejected the idea of spherical aberration before that time. John Mangus, a NASA Goddard optical engineer, who was present at the meeting with the Hughes Danbury group, pulled out his own computer diagram of the same effects. He had not previously shown it to others, and when Faber asked why, he said, “Well, I was waiting for you to show up and explain it.”²³

Holtzman presented his findings on spherical aberration on behalf of the WF/PC team to a weekly HST science team meeting on Monday, 25 June, the meeting Faber said was the event “when all doubt was erased.” Holtzman proved his point by showing a computer simulation of aberration based on his group’s estimate of the HST mirror defects alongside images from the real mirror. The matching images left the others at the meeting “pretty stunned,” as Faber recorded in her notes.²⁴ David S. Leckrone, then the deputy senior project scientist at Goddard, remembered the anger in Burrows’s voice as he discussed the spherical aberration at the meeting, and later he heard Marshall scientists joking about drinking hemlock. Leckrone suggested that scotch might be a better drink, because “we’re going to need you to puzzle out this problem.”²⁵ News of the spherical aberration spread to scientists assembling at Goddard for an HST science working group meeting. That day, Fisk returned to his office at NASA Headquarters following a successful negotiating trip to Europe and was confronted by Marshall experts with long faces and the news of Hubble’s spherical aberration. “Space science has just had its Challenger accident,” he recalled saying. “But I also remember saying that we were going to be judged not by what happened, but by how we recover from it.”²⁶

THE BAD NEWS

Wednesday, 27 June 1990, was the day most people found out that the Hubble Space Telescope was seriously flawed. For many involved with HST, the day started out with a painful meeting of scientists, followed by a press conference where the news of Hubble’s defective main mirror went out to the world. One reporter’s question summed up the prospects for HST as they were seen that day by asking, “[H]ave we ended up with a situation where you’ve degraded science or cancelled science?”²⁷

That morning, Marshall Deputy Project Manager Jean Olivier, Faber, and Burrows had laid out the grim facts of spherical aberration at a quarterly meeting of HST’s science working group at Goddard. In a discussion led by John Bahcall, glum instrument scientists who had spent years preparing to use the space telescope considered the impact of the defective mirror on their scientific plans. They also discussed ideas to repair the problem, including a proposal to

have astronauts replace HST's main camera, WF/PC, with a new instrument that would compensate for the mirror's defect.²⁸

The meeting later paused to watch the televised news conference broadcast from another building at Goddard featuring Fisk, HST Chief Scientist Ed Weiler, Olivier, Program Manager Doug Broome, and other officials explaining as best they could what the problem was with HST. The mirror was designed to put at least 70 percent of the energy from a star's image in a circle with a radius of $\frac{1}{10}$ of an arc second, but Weiler explained that the defective mirror could only put about 15 percent of the energy there. "I guess the important question in light of all this is can we do important and unique science?" he said. "That's the most important question and the answer is an emphatic yes." He noted that much of the work planned for the two spectrographs on board HST could still be done as planned. Shocked reporters asked questions about the possible causes and costs of the defective mirror, and they did not appreciate Weiler's

High Speed Photometer (HSP)

Time on HST:

24 April 1990–7 December 1993

Contractor:

University of Wisconsin Space
Astronomy Laboratory

Principal Investigator:

Robert C. Bless
(University of Wisconsin)

Weight: 270 kilograms
(595 pounds)

Axial Instrument

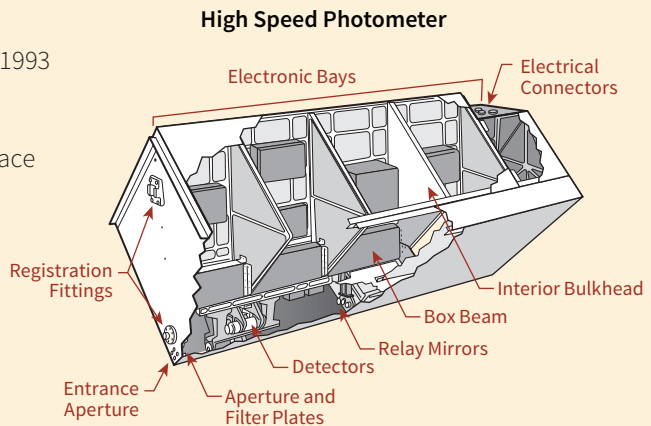

The High Speed Photometer made photometric measurements over visual and ultraviolet wavelengths. It stood out from other instruments on HST because it had no moving parts. HSP contained five detectors, including four image dissector

attempt to put a positive light on the situation. Weiler responded that the science was only deferred, and he reminded the media that HST had 15 years to accomplish its mission. Backed up by Fisk, Weiler pointed out that WF/PC could be replaced and the focus problem corrected as early as the first Shuttle servicing mission scheduled for 1993.²⁹

The measured words of the program officials at the 27 June press conference could not conceal the gigantic disappointment felt by astronomers. In newspaper interviews the following day, Sidney C. Wolff, director of the National Optical Astronomy Observatories, called the news “incredibly disappointing” and a “tragedy.” Astronomer Maarten Schmidt of Caltech said, “It’s a grim day for astronomy.” Two days after the press conference, NASA engineers at Cape Canaveral discovered a hydrogen leak in two Shuttle orbiters, forcing the Agency to ground the Shuttle fleet until October, raising more questions about NASA’s competence.³⁰

tubes and one photomultiplier tube. Because this instrument was in space, it was able to measure stars at ultraviolet wavelengths, and its measurements were more accurate because there was no variable atmospheric absorption of light.^a

As a highly precise light meter, HSP measured the brightness of objects it studied and found variations in the brightness of those objects, which could be caused by internal processes or by one object orbiting another. HSP was not strongly affected by HST’s mirror problems, and it was used to create highly accurate light curves for objects such as the pulsar in the Crab Nebula, investigate the structure of Saturn’s rings by measuring the light from stars passing behind the rings, and test theories of gravitational lensing.^b

When a place was needed inside Hubble’s axial bay for the COSTAR instrument in 1993, HSP was selected for removal.

HSP is now on display at the University of Wisconsin’s Space Place in Madison, WI.

a Robert C. Bless et al., *High Speed Photometer Instrument Handbook, Version 3.0* (Baltimore, MD: STScI, April 1992).

b James M. Lattis, *A Hubble Instrument Comes Home: UW Madison’s High Speed Photometer*, 2012, <https://spacegrant.carthage.edu/ojs/index.php/wsc/article/download/27/27/1/PB.pdf> (accessed 18 February 2017).

The *New York Times* called the mirror problem a calamity for NASA and questioned the need for “big science projects” when smaller and less expensive projects could do the job better, and *New Scientist* also raised questions about large-scale scientific programs in general. In a subsequent editorial about NASA’s problems, the *New York Times* suggested that NASA cancel its Space Station and other human space programs and redirect the money to high-technology development. A *Washington Post* front-page headline asked bluntly, “Can U.S. Get Things Right Anymore?” The 9 July issue of *Newsweek* carried an image of HST on its cover, calling it “NASA’s \$1.5 Billion Blunder.” *Space News* noted that the mirror problem hit NASA just as Congress was considering killing President George H. W. Bush’s Space Exploration Initiative, an ambitious plan that included human exploration of the Moon and Mars. The initiative ultimately didn’t last the year. Comedians and cartoonists also weighed in, depicting NASA as an incompetent institution wasting taxpayers’ money. In the words of Chaisson, “the summer of 1990 amounted to a public-relations cruise through hell.”³¹ Hubble’s problems were immortalized in a scene in the 1991 comedy film, *The Naked Gun 2-1/2: The Smell of Fear*, where a depressing bar full of unhappy people is lined with illustrations of major disasters, including the Titanic, the Hindenburg, the Ford Edsel, and HST.³²

As the days went on, journalists and politicians raised more critical questions about Hubble. U.S. Senator Al Gore (D-TN), who had run for President in 1988, called a special congressional hearing on HST starting two days after NASA’s announcement. Gore said he was “extremely dismayed” at NASA’s decision 10 years earlier to “almost destroy” its quality control capabilities, which he also linked to the loss of Challenger. “This is the second time in five years that a major project has encountered serious disruption by an inherent flaw that was apparently built into the project as much as 10 years before launch and went undetected by NASA’s quality control procedures,” Gore told the hearing.³³ After newspaper stories charged that NASA had decided to forgo a complete test of the assembled space telescope—a test unnamed military officials claimed was regularly performed on highly classified reconnaissance satellites—Gore also raised the matter in further Senate hearings in July, including one where former NASA Administrator James M. Beggs spoke about the same issue. At a House of Representatives hearing on Hubble’s woes, Representative Robert A. Roe of New Jersey, who had praised the program on the floor of the House when Hubble was launched, asked, “Is this thing a dud?”³⁴ Senator Barbara Mikulski, the Maryland Democrat who had up to then been known as a strong supporter of HST, called it a “technoturkey,” and later said, “The discovery of a serious flaw in Hubble’s primary mirror has dealt a devastating blow to NASA’s credibility.”³⁵

The continued unhappiness over the defective mirror extended to the astronomical community, starting with those who had not been convinced of the need to spend a massive amount of money on Hubble instead of on other astronomical facilities. Infuriated by the news of spherical aberration, others joined their ranks. James E. Gunn, the Deputy Principal Investigator for WF/PC, wrote a widely circulated letter castigating NASA and its “criminally infantile” quality control. “We have lost all control over our destiny,” Gunn wrote. “It was two billion of astronomy’s dollars that flushed down the drain.” He soon left the WF/PC team and moved on to spearhead the Sloan Digital Sky Survey. The continuing costs of operating the troubled space telescope added to the questions about its future.³⁶

Those who continued to work on HST could not escape the negativity that summer, and a few HST managers faced personal problems as a result. Charles Pellerin sought relief that summer from the tense congressional hearings on the Hubble problems by attending a concert. When a microphone failed to work, a performer joked about HST. “We were the laughingstock of the country,” said Weiler, recalling how neighbors would speak of HST as a “national disaster.” He had told reporters, members of Congress, and anyone who would listen that Hubble’s problems could be at least partially solved. But “nobody believed us.”³⁷

ENDNOTES

- 1 “STS-31 Press Kit,” pp. 22–29, quotation 22; Kathy Sawyer, “Hubble Telescope Spreads Its Wings,” *Washington Post* (26 April 1990): A1; John Noble Wilford, “Telescope Is Orbiting After a Tense Delay,” *New York Times* (26 April 1990): B12.
- 2 “STS-31 Press Kit,” pp. 22–29.
- 3 Both the main and secondary mirrors in Ritchey-Chrétien telescopes have hyperbolic shapes, and they are modern types of Cassegrain reflecting telescopes, where the secondary mirror is curved instead of flat as in Newtonian reflecting telescopes. Many large optical telescopes today use the Ritchey-Chrétien configuration, which was invented early in the 20th century to reduce the possibilities of optical defects such as spherical aberration.
- 4 Smith, *The Space Telescope*, pp. 440–441; “STS-31 Press Kit,” pp. 14–16.
- 5 Lockheed Missiles & Space Company, Inc., *Hubble Space Telescope Media Reference Guide* (Sunnyvale, CA: Lockheed Missiles & Space Company, 1990), pp. 2-11–2-14. HST was not equipped with thrusters to point itself because they would require regular refueling and leave deposits on the optics. NASA “STS-125 Press Kit,” May 2009, pp. 4–5.
- 6 “STS-31 Press Kit,” pp. 14–16.

- 7 Space Telescope Science Institute, *Wide Field—Planetary Camera Instrument Handbook, Version 3.0* (Baltimore, MD: STScI, April 1992); Eric J. Chaisson, *The Hubble Wars* (New York: HarperCollins Publishers, 1994), pp. 124–127.
- 8 “STS-31 Press Kit,” pp. 22–29.
- 9 “STS-31 Press Kit,” pp. 22–29; “Space Telescope European Coordinating Facility,” *ESA Bulletin*, no. 142 (May 2010): 4–5. The National Research Council of Canada operates the Canadian Astronomy Data Centre at the Dominion Astrophysical Observatory in Victoria, BC, Canada. See oral history interview by author with Dennis Crabtree, Daniel Durand, and Andrew Woodsworth, 18 August 2017.
- 10 NASA, “Hubble Memorable Moments: The Tinkertoy Solution,” YouTube video, posted 23 September 2015, <https://www.youtube.com/watch?v=ZkoGnnjQlcM&t=13s> (accessed 8 January 2017).
- 11 European Space Agency, “How Hubble Got Its Wings,” http://www.esa.int/Our_Activities/Space_Engineering_Technology/How_Hubble_got_its_wings (accessed 15 August 2015); Carleton Foster et al., *The Solar Array-Induced Disturbance of the Hubble Space Telescope Pointing System: NASA Technical Paper 3556* (Huntsville, AL: Marshall Space Flight Center, May 1995); Carlton L. Foster, Michael L. Tinker, Gerald S. Nurre, and William A. Till, “Solar-Array-Induced Disturbance of the Hubble Space Telescope Pointing System,” *Journal of Spacecraft and Rockets* 32, no. 4 (July–August 1995): 634–644; Larry Dunham, oral history interview by author, 19 September 2017, p. 8.
- 12 Paul Hoversten, “‘New Era’ for Mankind Will Open Today,” *USA Today* (25 April 1990): A1.
- 13 “Top Ten List Archive for 1990: Top 10 Hubble Telescope Excuses,” *Orlando Sentinel*, http://articles.orlandosentinel.com/1990-05-17/news/9005170447_1_david-letterman-telescope-hubble (accessed 11 October 2017); Rob Stein, Untitled United Press International Dispatch on Hubble Space Telescope problems, 21 May 1990, clippings file 5982, NASA Historical Reference Collection, NASA History Division, NASA Headquarters, Washington, DC (henceforth “NASA HRC”). The Top Ten List was presented most nights on the Letterman show during its long run on NBC and later CBS from 1982 to 2015. Interestingly, this Letterman Top Ten List is the only one from 1990 through June 1993 to feature the Hubble Space Telescope, although HST was occasionally mentioned in Top Ten Lists on other topics. Popular belief incorrectly holds that HST made the Top Ten List after spherical aberration was announced more than a month later.
- 14 Al Boggess, oral history interview by author, 21 September 2015, pp. 5–7; Chaisson, *The Hubble Wars*, pp. 97–120; Ray Villard, oral history interview by author, 30 October 2015, pp. 4–7. Although several statements made by Chaisson in his book have been questioned by other participants, the basic facts of the events leading up to the release of HST’s “First Light” image were confirmed by Villard.
- 15 The transcript of Fisk’s painful exchange with reporters is reproduced in Chaisson, pp. 116–120. As noted in the prologue, the 10 April launch attempt was scrubbed late in the countdown, and HST was launched on the second attempt two weeks later.
- 16 Warren E. Leary, “Sky Clear, Space Telescope Starts to See Forever,” *New York Times* (21 May 1990): B10; Kathy Sawyer, “Hubble Space Telescope Returns First Images,” *Washington Post* (21 May 1990): A4; Space Telescope Science Institute, “First Image

- Taken by Hubble's Wide Field Planetary Camera," news release STScI-1990-004, 20 May 1990; Chaisson, *The Hubble Wars*, pp. 130–134.
- 17 Pellerin OHI, p. 26; Christopher Burrows, oral history interview by author, 15 February 2017, pp. 8–11; Sandra Faber, oral history interview by author, 29 September 2016, pp. 11–15; Tod Lauer, oral history interview by author, 15 August 2016, p. 6. Recollections vary of Lynds's first reaction to the images. Burrows thought that Lynds was confused by the images at first, but Faber recalled that he spoke of spherical aberration. Lauer said Lynds "has great intuition, and he was dead-right, but he didn't know how to support his conclusion." Lauer compared Lynds to "Doc" Emmett Brown, a fictional eccentric scientist in the popular *Back to the Future* films of the 1980s, and said he had to deal with "suits" working on HST's problems.
 - 18 Lauer OHI, p. 6. Lauer was just beginning work at the National Optical Astronomy Observatory at Kitt Peak in 1990 after postdoctoral work at Princeton. His Ph.D. advisor had been Sandra Faber.
 - 19 Letter, Sandra Faber to Jim Westphal, 8 June 1990. Copy supplied by Faber.
 - 20 Faber OHI, pp. 11–15; copy of Sandra Faber WF/PC team notebook from 1990 to 1993.
 - 21 STScI, "ESA's Faint Object Camera First Images," news release STScI-1990-06, 22 June 1990; Villard OHI, 30 October 2015, pp. 6–7; Smith, *The Space Telescope*, p. 407. In her notes in her copy of Chaisson's book *The Hubble Wars*, p. 144, Faber stated her agreement with Chaisson's criticism of the release image in *The Hubble Wars*. Villard later called the photo release "a little fast and loose" given that much of the light that landed improperly outside the proper place because of spherical aberration had been removed in processing. Duccio Macchetto, the Principal Investigator for FOC, responded to these criticisms by saying that the FOC image in the release was processed the same way as the WF/PC "First Light" image, and he said the ground image was the best available at the time. Macchetto, e-mail to author, 11 October 2017.
 - 22 Faber OHI, pp. 16–18; Burrows OHI, p. 11; Faber notebook; Burrows note of 19 June meeting. Hughes Aircraft had purchased Perkin-Elmer in 1989 and renamed it Hughes Danbury. See also William G. Crabb, oral history interview by author, 4 January 2018, pp. 3–5.
 - 23 While Faber took Mangus's decision to delay showing his computer printout as stemming from concerns for his job, it is possible that Mangus thought his findings might not be accepted by Marshall experts because of the Center's rivalry with Goddard, and he knew that others would soon announce that they had reached a similar conclusion. Faber OHI, pp. 16–17; Robert Smith, 13 May 2019, comments on draft of this book. H. John Wood, "Some Personal Recollections About the Recovery of Hubble Space Telescope Optical Performance 1990–1993," undated manuscript, also talks about Mangus's concerns. Lauer, in his OHI, p. 6, said, "Marshall had the keys to the telescope, and the people at Goddard were largely waiting for the Marshall people to finish up and go home." See also Robert Zimmerman, *The Universe in a Mirror* (Princeton, NJ: Princeton University Press, 2008), pp. 135–136.
 - 24 Faber OHI, pp. 17–18; Faber notebook.
 - 25 David Leckrone, oral history interview with the author, 6 May 2015, pp. 9–10.

- 26 Lennard Fisk, comments at an HST 25th anniversary panel, “Spherical Aberration: From Disaster to Glory,” Johns Hopkins University, 23 April 2015.
- 27 Transcript, “Hubble Space Telescope Status Briefing,” 27 June 1990, NASA HRC.
- 28 Faber, notes of 27 June meeting.
- 29 Transcript, “HST Status Briefing,” 27 June 1990; John Trauger, “Wide Field and Planetary Camera 2: ‘The Camera That Saved Hubble,’” undated memoir. Two people who might otherwise have been at the briefing were away that day. STScI director Riccardo Giacconi was in Italy, and Charles Pellerin, NASA’s Director of Astrophysics, was returning from Japan and was informed while changing planes. He did not believe the news of spherical aberration until he saw a newspaper with the story. Pellerin OHI, pp. 27–28.
- 30 Warren E. Leary, “Hubble Telescope Loses Large Part of Optical Ability,” *New York Times* (28 June 1990): A1; Bob Davis, “NASA Finds Hubble Mirror Is Defective,” *Wall Street Journal* (28 June 1990): A1; Tom Wicker, “Beyond Murphy’s Law,” *New York Times* (19 July 1990): A23.
- 31 “Calamities in Space,” *New York Times* (1 July 1990): 16; “The Trouble with Hubble,” *New Scientist* (7 July 1990): 18; “Rethink Space,” *New York Times* (20 July 1990): A20; John Burgess, “Can U.S. Get Things Right Anymore?” *Washington Post* (3 July 1990): A1; “NASA’s \$1.5 Billion Blunder,” *Newsweek* (9 July 1990); “More to Fix Than Hubble,” *Space News* (July 2–8, 1990): 14; Thor Hogan, *Mars Wars: The Rise and Fall of the Space Exploration Initiative* (Washington, DC: National Aeronautics and Space Administration, August 2007), pp. 120–122; Chaisson, *The Hubble Wars*, p. 192.
- 32 *The Naked Gun 2-1/2: The Smell of Fear*, directed by David Zucker (Paramount Pictures DVD, 1991).
- 33 U.S. Congress, Senate, Committee on Commerce, Science, and Transportation, Subcommittee on Science, Technology, and Space, *Status of the Hubble Space Telescope*. 101st Cong., 2nd sess., 29 June 1990 (Washington, DC: U.S. Government Printing Office, 1990).
- 34 U.S. Congress, Senate, Committee on Commerce, Science, and Transportation, Subcommittee on Science, Technology, and Space, *Hubble Space Telescope and the Space Shuttle Problems*, 101st Cong., 2nd sess., 10 July 1990 (Washington, DC: U.S. Government Printing Office, 199); U.S. Congress, House of Representatives, Committee on Science, Space, and Technology, *Space Telescope Flaw: Hearing Before the Committee on Science, Space, and Technology* 101st Cong., 2nd sess., 13 July 1990, (Washington, DC: U.S. Government Printing Office, 1990), pp. 2, 8; “The Successful Launch of the Hubble Space Telescope,” *Congressional Record*—House of Representatives, 24 April 1990.
- 35 Smith, *The Space Telescope*, p. 414; Warren E. Leary, “NASA Was Curbed in Checking Mirror,” *New York Times* (19 July 1990): A15.
- 36 “Heaven Can Wait,” *Newsweek* (9 July 1990): 51–53; Smith, *The Space Telescope*, pp. 415–416; “Hubble’s Troubles: Reflections from the Editor,” *Sky & Telescope* (October 1990): 340–341; e-mail, Jill Knapp to Tod Lauer, 19 July 1990, no title, copy of letter from Jim Gunn, Princeton University, to Dr. J. N. Bahcall, Institute for Advanced Studies, 16 July 1990, with attachment of letter from Jim Gunn to Garth Illingworth, 8 July 1990. Quotation is from 8 July letter. See also Ann K. Finkbeiner, *A Grand and Bold Thing: An*

Extraordinary Map of the Universe Ushering In a New Era of Discovery (New York: Free Press, 2010), pp. 1–6. Ironically, years earlier Gunn had coaxed Westphal, who was wary of NASA programs, into becoming Principal Investigator for WF/PC.

- 37 Pellerin OHI, pp. 28–32; Edward Weiler, oral history interview with author, 24 October 2016, pp. 7–8. Weiler said some people “disappeared,” and Pellerin spoke of HST managers requiring help for drinking problems and blamed the 1992 death of HST Program Manager Douglas Broome at age 55 on his despair over HST. Bill Crabb, an HST engineer and controller, remembers that a waitress “chewed me out” over HST when she found out he worked on HST. Crabb OHI, p. 15.

CHAPTER THREE

The Road to Recovery

▲ This image of the Crab Nebula is the largest image ever taken with Hubble's WFPC2 camera. It was assembled from 24 individual exposures in 2005. (NASA/ESA/Allison Loll/Jeff Hester [Arizona State University]. Acknowledgment: Davide De Martin [ESA/Hubble]: heic0515a)

For Hubble Space Telescope Chief Scientist Ed Weiler, 27 June 1990, was the Death Valley—the low point—of the many years he spent working on HST. The news of HST's spherical aberration had come just two months after the figurative Mount Everest of HST's launch in April. But even amidst the gloom of the scientific working group meeting that day at Goddard and the subsequent news conference, the first sign of Hubble's turnaround also emerged. Weiler and other NASA leaders had very little success that day convincing reporters that HST could be repaired or that the long-promised great science would eventually be delivered. The massive disappointment that NASA and its contractors faced that summer made the challenge of actually restoring the telescope's focus and its scientific potential look even larger. But NASA's massive investment of money and work in HST was at stake, and before the fix could be effected to Hubble three and a half years later, the future of NASA itself would also be in play.¹

"MIRROR MIRROR, ON THE HUBBLE,
WHO IS FREE OF BLAME FOR TROUBLE?"



▲ HST's defective main mirror became the subject of many editorial cartoons, including this Herblock cartoon in the *Washington Post*, 11 July 1990. (A 1990 Herblock Cartoon, © The Herb Block Foundation)

A NEW CAMERA

Weiler faced the media with the knowledge that HST was designed to be regularly serviced by astronauts on board the Space Shuttle, which meant that unlike most spacecraft, several opportunities existed to repair Hubble. In particular, Weiler had long been aware that a new Wide Field/Planetary Camera (WF/PC) was being developed for installation on the first planned HST servicing mission, planned for June 1993. That was because Weiler himself had proposed the replacement instrument back in 1983. With spherical aberration now confirmed in HST's main mirror, there were many questions to be answered before the work on correcting the defect could begin in earnest. At the science working group meeting that preceded the press conference, Weiler heard from John Trauger, an astrophysicist from the Jet Propulsion Laboratory (JPL),

who was Principal Investigator for the replacement camera. Trauger believed it could restore HST's eyesight, at least for that one instrument. The success of the camera was especially important to taxpayers since it was expected to produce most of the images from HST.²

When he first proposed WFPC2 in 1983, Weiler was concerned about the effects of a possible failure of WF/PC on both the science output of HST and public support for the telescope. "To maintain the tremendous public appeal of the ST [Space Telescope], we must ensure that the ST produces both excellent science and 'pretty

pictures' of planets, star clusters, etc.," he wrote. "As a spectroscopist myself, I feel uneasy saying this, but no matter how much good physics comes out of [HST's spectrographs], the general public will consider the ST a loss if it does not produce early and continuing unique views of the universe." Weiler said that work should begin then on a new WF/PC since having to bring WF/PC back to Earth for refurbishment and then return it on a subsequent Shuttle flight would be far more expensive and time consuming than building a replacement.³



▲ The spherical aberration in HST's main mirror did not prevent the release of HST images that were better than those obtainable from observatories on Earth. This image of Saturn was obtained by WF/PC on 26 August 1990. (NASA/STScI: STScI Release 90-11)

By the time HST downlinked its first images in May 1990, WFPC2 was well along in fabrication at JPL. At a meeting that month in JPL's WF/PC data analysis area, Trauger showed HST's first blurry images to Aden and Marjorie Meinel, both distinguished astronomers who had collaborated on building many astronomical instruments on Earth and in space. The Meinels told Trauger that they thought the images were affected by spherical aberration, and Aden Meinel suggested that the problem could be fixed for WFPC2 if the new instrument's internal optics were reworked before launch. Together with optical designer Norm Page, Trauger used JPL's computer model of HST's optical system to see what changes could be built into WFPC2 to overcome HST's spherical aberration, even if it stemmed from errors in both the primary and secondary mirrors in the telescope. Trauger travelled to Goddard for the 27 June science working group meeting where the news of the spherical aberration was broken to the scientists, and Trauger presented the results of his research in a memorable fashion: "I held up a nickel to illustrate the size of the mirrors inside WFPC2 on which the imaging correction could be made." Weiler mentioned Trauger's plan for WFPC2 at the press conference, but it was lost amidst the devastating news of the mirror defect.⁴

SEARCHING FOR CAUSES

When NASA Associate Administrator Lennard Fisk revealed the discovery of spherical aberration alongside Weiler, he also announced that the important work of determining its cause was being given to a review board headed by General Lew Allen, Jr., a former U.S. Air Force Chief of Staff who was then the director of JPL. NASA formed the HST Optical Systems Board of Investigation on 2 July with Allen as chair.⁵ At the time, HST program officials didn't know whether the problem resided in the telescope's main or secondary mirror or both. The Allen Committee investigation quickly focused on the firm that had ground and completed both mirrors,



▲ Lew Allen, Jr. at the time he was Director of the Jet Propulsion Laboratory in the 1980s.

(NASA/JPL-Caltech)

the recently renamed Hughes Danbury Optical Systems Inc. Everything there pertaining to the HST mirrors was impounded by about 35 staff members from NASA and the contractor. At the committee's second meeting in late July, the full board was able to inspect the null corrector and test stand used for HST's main mirror, which fortunately had been left undisturbed in place since the mirror's completion nine years earlier because there was no other use for it. At a public session during the committee's third meeting in mid-August, the board was told that Hubble's main mirror had been ground to the wrong shape because of a lens spacing error in the null corrector test apparatus. During its next meeting in September, the committee heard more on how the error had been introduced to the null corrector. In its report two months later, the Allen Committee also described tests performed on the mirror using other equipment that showed the error but had been ignored.⁶

The Allen Committee was not the only group examining HST's mirror problem. NASA set up the Hubble Independent Optical Review Panel at Goddard to provide precise technical information on the shape and condition of the HST mirrors, which were not well understood at the time, to facilitate the creation of measures to counteract the errors. The panel was chaired by Duncan T. Moore, Director of the University of Rochester's Institute of Optics, and included George N. Lawrence of Applied Optics Research, Daniel Schulte of the Lockheed Optical Systems Laboratory, Dietrich Korsch of Korsch Optics, and Marjorie and Aden Meinel from JPL. The panel began planning to hold just one session on 5 July, but Charles Jones of NASA Marshall Space Flight Center asked Moore to chair a formal panel. A number of people from NASA, Hughes Danbury, and elsewhere worked as advisors for the panel, including John D. Mangus and H. John Wood from NASA Goddard Space Flight Center and Christopher Burrows from ESA and STScI. The panel continued its work for more than a year. Its early meetings drew more than 200 people, but attendance fell off as the exact nature of the spherical aberration in HST's main mirror became better understood. The panel was assigned to look into the possibility that HST's secondary mirror was also defective, but they found that it met specification. The panel's work included developing a full understanding of the shape of HST's mirrors using recent measurements made on the HST primary and secondary mirrors in space, the so-called fossil measurements made a decade earlier when the mirror was being polished, and tests on the backup mirrors left on the ground. The panel's highly technical final report contained many studies from experts in the field of optics and provided an accurate figure for the HST primary mirror's conic constant, -1.0139 . Knowing this figure, which describes the shape of the mirror, permitted the creation of new optics to counteract the mirror's defect.⁷

NASA's Office of Inspector General commenced an investigation in August into the question of whether the mirror's contractor had followed proper procedures as it had certified. In September, Senator Barbara Mikulski asked the office to investigate and report to the Senate Committee on Appropriations. In a report on 8 January 1991, the Inspector General's report found "apparent reckless disregard" by Perkin-Elmer managers on the veracity of information they provided on the quality of the mirror, and referred the matter to the Department of Justice for possible prosecution under the False Claims Act. The report estimated the cost of the defective mirror at \$50 to \$60 million, based on the idea that since a Shuttle servicing mission was already scheduled to fly to HST before the spherical aberration was discovered, the cost of the mirror problem would not include an additional Shuttle mission. The Justice Department decided to pursue the case, and on 4 October 1993, it announced that it had reached a settlement on behalf of NASA with both Perkin-Elmer and Hughes Danbury where the two contractors paid the U.S. government \$25 million, including \$15 million in cash, \$3.5 million in waived fees under the contract to build and maintain the telescope, and \$6.5 million in costs that the contractors refunded to NASA for continuing work involving HST. In return, the government released the companies from further liabilities in the matter.⁸

STRATEGIES PANEL

The appearance of the spherical aberration problem in June 1990 took place at a difficult moment for NASA, just as Marshall was handing over responsibility for the Hubble project to Goddard. And at NASA Headquarters and Goddard, the initial response to the news was dismay in spite of brave words from those like Fisk. David Leckrone, then the deputy project scientist, described the reactions of his colleagues this way saying, "Well, what the hell are we going to do?' And, 'This is so embarrassing.' And, 'Let's figure out what went wrong, so it won't go wrong in the next project,' and that sort of thing. There was no, 'Let's charge into battle. Let's get rid of this problem.'" Fisk admitted later that NASA was looking for anyone who could figure out how to overcome HST's newly discovered problem.⁹

Even while the inquiries into the causes of the mirror problem were beginning in July, NASA made management changes to point the Hubble program toward solutions to its problems. Joseph H. Rothenberg, whose résumé included experience with OAO and Solar Max and a stint as Operations Manager for HST from 1983 to 1987, returned to HST at Goddard after the discovery of its mirror problem. He was given two titles: HST Project Manager and Associate Director for Flight Projects, with responsibility for repairing Hubble. He and



▲ Joseph Rothenberg, who was Hubble Program Manager during Servicing Mission 1, speaks in 2018. (NASA/W. Hrybyk)

Project Scientist Al Boggess soon decided on a plan that involved learning about the causes of HST's problems, working to solve those problems, and continuing to develop second-generation instruments for Hubble.¹⁰

Astronomers who had been looking forward to working with HST felt sure that replacing the defective mirror could not be done without bringing it back to Earth, which invited major technical and political problems. Some wondered whether politicians would continue to fund the troubled HST in any case, or whether scientists would continue to support Hubble as they had done while it was being built. It was not immediately clear whether the defects in the mirror could be accurately measured so that new instruments such as WFPC2 awaiting installation on upcoming Shuttle servicing missions could be modified to compensate for the mirror's defects. Boggess said, "There was a group that said, 'Well, let's get as much astronomy done as we can with what we've got, particularly since we don't know how long the whole thing's going to last, anyway.'"¹¹ When Weiler's promise that WFPC2 was already being built and could be modified was backed up with the news that the precise nature of the main mirror's problem was understood, questions about the fate of the other four instruments on HST remained open. Early on, it appeared that these instruments would

have to work with HST's aberrated main mirror, and that only the second-generation instruments that would replace them in servicing missions in 1996 or even later could be modified to allow full use of their capabilities. This was not good news for the scientists who were starting to use the first-generation instruments on board HST, especially the European scientists who were working with ESA's Faint Object Camera.¹²

All five instruments and the three Fine Guidance Sensors inside HST were designed for easy changeout by Shuttle astronauts. Four of the five instruments were known as axial instruments because they were mounted at the rear of the telescope along its optical axis. These instruments were shaped roughly like phone booths, and because of their location in the telescope, light from the telescope's mirrors could enter them directly. WF/PC and the three Fine Guidance Sensors were radial instruments located between the axial instruments and the main mirror and to the side. These instruments were shaped like baby grand pianos, and because of their location, they were equipped with pickoff mirrors in the telescope's optical path to redirect light into them.

The scientists whose work would suffer without a fix to all the HST instruments naturally expressed concerns about the fate of those instruments, and they were afraid that NASA would be satisfied with only installing WFPC2. At a staff meeting at the Space Telescope Science Institute the day after the spherical aberration was announced, Faint Object Spectrograph team member Holland C. Ford of Johns Hopkins suggested that STScI should form a group to develop solutions for the spherical aberration problem. STScI Director Riccardo Giacconi was away in Italy and no one else took up the idea, but Ford brought up the idea again at another meeting early in August, and this time, Giacconi was present and gave his assent. By then, Robert A. Brown, a staff astronomer at STScI, was also proposing an institute initiative. Giacconi appointed Brown and Ford as co-chairs of the HST Strategy Panel, which had many other high-powered members, including Christopher Burrows; James Crocker; Rodger Doxsey; Pierre-Yves Bely and Francesco Paresce from STScI; HST's father figure Lyman Spitzer; Sandra Faber; newly retired NASA Astronaut Bruce McCandless; Jacques Beckers and Raymond Wilson from the European Southern Observatory; Piero Benvenuti from the ESA's European Coordinating Facility for HST; Murk Bottema from Ball Aerospace; Edward Groth, like Spitzer, from Princeton University; and Shrinivas Kulkarni from Caltech.¹³

The problem the Strategy Panel faced was that while changes to the optics inside each of the five scientific instruments aboard HST could restore clear vision, it would not be possible to change all the instruments during the first or even the first and second Shuttle servicing missions. Starting with a "clean

sheet of paper” at its first meeting on 17 and 18 August, the Strategy Panel brainstormed ideas and looked at 20 possible ways to change HST’s primary or secondary mirror to reduce or eliminate the spherical aberration and nine ideas to change the instruments to deal with the problem. The proposals included bending or coating the main mirror, replacing the secondary mirror, installing corrective mirrors or lenses, masking part of the main mirror, or even partially closing the aperture door to reduce the mirror problem.¹⁴ McCandless, who had flown on the mission that deployed HST, warned the panel at its first meeting that ideas involving astronauts going into the barrel of the telescope were too dangerous. Optical expert Murk Bottema suggested using specially shaped coin-size mirrors to reverse the spherical aberration in three other HST instruments, but his proposal did not spell out how to mount the mirrors inside the telescope. Brown remembered that Spitzer, then 76, took an active role in the panel’s work, conferring frequently with Bottema over optical questions.¹⁵

Strategy Panel members discussed Bottema’s idea during their second meeting on 3 and 4 September at the ESA’s European Coordinating Facility for HST near Munich in Garching, Germany. James Crocker, an electrical engineer who was head of the operations division at STScI, decided to clean up before dinner at the meeting, and he used a shower in his room that was of a design common in Europe but not in the United States at the time. He found the shower head attached to a pivot on a pipe which allowed the head to be moved up or down. As Crocker bent over to raise the shower head, he got an idea for a way to easily install Bottema’s small mirrors. “It all just kind of all clicked,” Crocker remembered. “It’s like, oh, if we took out an instrument, and put in a new package, and it had like this shower head thingy that would pop up and flip out, correcting instruments in front of the other apertures, this would work, because the astronauts could do that job. They were trained to do that job. They had the tools to swap out an instrument. But instead of an instrument, it would be a corrective optics package to flip over in front of the other instruments.”¹⁶

The next morning, Crocker went to the meeting armed with viewgraphs of his idea. Though he expected someone on the panel to knock it down, as had happened to so many other ideas that had been found wanting, his proposal survived the panel’s scrutiny. McCandless, with his viewpoint as an astronaut, approved of the idea. Crocker also made a Styrofoam model of the telescope’s focal plane to show where corrective mirrors could go. And even better, the panel was told that NASA already had a dummy axial instrument named STAR (Space Telescope Axial Replacement). STAR had been designed to be placed inside HST and maintain balance inside HST in case one of the instruments wasn’t ready to fly. Goddard had contracted with the University of

Wisconsin, which was building the High Speed Photometer, to also build STAR in case it was needed. There was discussion of modifying STAR by adding corrective mirrors and the small mechanical arms that would move them into the telescope's light path as Crocker proposed, creating a new instrument called COSTAR or Corrective Optics Space Telescope Axial Replacement.¹⁷

Because the new WFPC2, a radial instrument, would incorporate changes to compensate for spherical aberration, the remaining four instruments were axial instruments, and COSTAR could be used to correct the vision of axial instruments. But there was a downside to the idea. COSTAR would have to take the place of one of the four axial instruments. Two of them were

spectrographs, which provide crucial information about the makeup of the stars and other objects, and another was the Faint Object Camera provided by the European Space Agency, a camera with seven times the resolution of WFPC2. The fourth axial instrument was the High Speed Photometer. The photometer was not used as much as the other instruments, so it quickly became the chosen candidate to give way for COSTAR. The photometer was far simpler and smaller than the other instruments, and its presence on HST was seen as something of an "experiment."¹⁸ The graceful acceptance of this decision by HSP's Principal Investigator, Bob Bless of the University of Wisconsin, has been widely noted and praised by the astronomy community. HSP scientists also went the extra mile by making available calibration data about the apertures of other HST instruments that made it possible for COSTAR to align its own mirrors to the other instruments. Because HSP wasn't an imaging instrument, the spherical aberration didn't strongly affect its work, so observations



▲ James Crocker, who played a major role in dealing with HST's spherical aberration problem while at STScI in the early 1990s, photographed in 2015. (NASA/Joel Kowsky)

using it were given priority before its removal. Nevertheless, the astronomers who used it felt the loss keenly.¹⁹

In addition to its recommendation for COSTAR, the strategy panel also examined NASA and ESA's work on HST's pointing problems resulting from jitter caused by the solar arrays, along with NASA's work on WFPC2. The panel reported to Giacconi in October, and after he endorsed its report, the panel went to NASA Headquarters on October 26. NASA officials, including Director of Astrophysics Charles Pellerin at Headquarters and Joe Rothenberg at Goddard, studied the plan and authorized work to start on COSTAR in December, although it would take some time before the idea was officially endorsed.²⁰

STARTING RESEARCH WORK

While NASA, STScI, and contractors worked on solutions to the mirror's spherical aberration, astronomers began using HST for research. Even on the day NASA announced HST's defect, STScI news chief Ray Villard spoke for those astronomers who remained optimistic when he said, "Everyone expects there will be a full scientific mission ahead. This problem is not likely to have a lasting impact on science."²¹ STScI deputy director Peter Stockman told Congress in July that HST's observations in ultraviolet wavelengths were still better than anything available before, and observations using spectrographic instruments and the High Speed Photometer were not as strongly affected as those observations involving imaging. Accordingly, the Institute began to rearrange HST's observing program to reflect those realities. Stockman testified that 33 percent of the telescope's original observation programs for its first observing cycle could be carried out as planned, while 56 percent were still viable. Distant observations requiring high resolution from WF/PC and FOC would have to be postponed. Limited imaging could still go ahead with the help of computer processing.²²

Hopes that HST would return useful scientific data were rewarded quickly. An image WF/PC obtained on 3 August of a star-forming region, 30 Doradus in the Large Magellanic Cloud, showed far more stars than could be seen in any image taken from the ground. This image arrived almost by accident because astronomers were testing the HST instruments to learn how they worked, and this image was intended as a finding chart for another HST instrument, the Goddard High Resolution Spectrograph. After undergoing computer processing to ameliorate the effects of spherical aberration, the HST image clearly showed 60 stars. The best ground-based images only showed eight fully resolved stars and suggested as many as 27. "We knew we were sitting on a pot of gold," Goddard astrophysicist Sally Heap said. "We now have the finest family portrait of stars outside our galaxy."²³

As the weeks went on, NASA and STScI released more Hubble images that provided views superior to those possible from the ground-based telescopes of objects as close as Saturn and Pluto and as far away as the Orion Nebula, the remnants of a recently exploded supernova, and in a few cases, even distant galaxies. Hubble was able to resolve brighter objects, such as quasars, and John Bahcall reckoned that scientists could look for gravitational lensing related to quasars. Images of dimmer and more distant objects were strongly affected by the mirror problem, postponing work such as trying to determine the distances of distant galaxies to help determine the size and age of the universe. Computer processing known as image deconvolution could tease out details in aberrated images, particularly of relatively bright objects. Tod Lauer, a member of the WF/PC team, explained that image deconvolution was useful in some but not all situations, such as the 30 Doradus image and images tracking the evolution of a gigantic storm on Saturn. Despite the early trickle of good news stories about Hubble, many politicians and members of the public still saw an aura of failure around the program. But six weeks after the spherical aberration announcement, Hubble was no longer a major story—on 2 August, Iraqi troops under President Saddam Hussein invaded Kuwait. Military forces from the U.S. and allied countries responded by liberating Kuwait and invading Iraq in the Gulf War, which came to a climax the following February.²⁴

While America's attention was focused overseas in the final months of 1990, the Allen Board had found the cause of HST's spherical aberration, scientists and engineers were well on the way to understanding the extent of the mirror's problems, and experts at Goddard, JPL, and STScI were starting work on modifying WFPC2 and creating COSTAR to clear HST's vision. Those experts worked in a welter of formal and informal committees to help the Independent Optical Review Panel in its work, discuss how to modify WFPC2 and second-generation instruments slated for installation in HST later in the decade, and starting in November, work on creating COSTAR.²⁵ On 1 October, NASA officially transferred operational responsibility for HST from Marshall Space Flight Center, which had been responsible for Hubble's construction, to Goddard Space Flight Center. After they completed their work on the orbital verification program for HST, the remaining members of the Marshall HST team returned home to Huntsville from the Space Telescope Operations Control Center in Greenbelt. NASA decided on 12 November that despite ongoing problems with HST, including the effects of the jitter from the solar arrays, the commissioning phase of HST operations was over.²⁶

In November, Goddard Lead Optical Engineer and astrophysicist H. John Wood recorded in a set of journals he kept that the meetings he attended began

to turn to the matter of the servicing mission that would carry out repairs to restore HST's vision. His colleagues from NASA and STScI discussed how to ensure that COSTAR would actually fit inside the telescope and also fit within budgets for the repair work.²⁷

READYING REPAIRS IN SPACE

By the time talk turned that fall to installing COSTAR during the first Shuttle servicing mission to HST, that mission had been under consideration for several years in various places around NASA. In one sense, work on the mission began shortly after NASA decided in 1984 against returning Hubble to Earth for refurbishing. The following year NASA named two spacewalkers to the HST deployment mission, who not only began to get ready for their own mission but also put a great deal of effort into preparations for future servicing missions that would involve what NASA called Extra-Vehicular Activity, or EVA. Both astronauts had performed groundbreaking EVAs in 1984—Bruce McCandless became the first astronaut to make an untethered free spacewalk using the Manned Maneuvering Unit (MMU), and Kathryn D. Sullivan became the first American woman to walk in space.

McCandless, Sullivan, and everyone else involved in human spaceflight knew that doing useful work in open space during EVAs was both difficult and dangerous. Spacewalking astronauts learned hard lessons about the need for preparation during Gemini flights in 1965 and 1966, and the knowledge gained led to successes later, notably dramatic repairs by spacewalking astronauts to the Skylab space station after it had been damaged during launch in 1973. The first spacewalk from a Shuttle took place on the STS-6 mission in April 1983, when astronauts Donald Peterson and Story Musgrave tested the specially designed Shuttle Extravehicular Mobility Units (EMUs) in Challenger's payload bay. Both McCandless and Musgrave had previously served on the backup crew for the first flight to Skylab, and both developed an interest in EVAs that carried into the Shuttle Program. Sullivan, who had been selected as an astronaut in 1978, volunteered to work with McCandless as he tested equipment for Shuttle spacewalks at the Marshall Space Flight Center in what was then NASA's largest neutral buoyancy facility, a giant water tank equipped with structures simulating spacecraft.²⁸

When Sullivan and McCandless began formally preparing in 1985 for their roles in the HST deployment mission, the flight was due to take place in 1986, and HST was nearing completion at Lockheed in California under the supervision of managers from NASA Marshall. Following the decision to service Hubble on orbit, engineers from Lockheed, Marshall, and the Johnson Space

Center worked to make that work as easy as possible. In early tests in the tank at Marshall, McCandless and Sullivan assessed worksites in and near the space telescope on a mockup of HST and proved that the existing foot restraints, which were vital because astronauts need a stable and easy-to-use platform from which to work, needed to be redesigned.²⁹

When the Space Shuttle Program began, NASA put a priority on using the Shuttle for servicing satellites and other spacecraft. To that end, NASA built a few satellites in the 1970s with modular systems, including the Solar Maximum Mission, which was launched in 1980. Engineers from the Goddard Space Flight Center fitted the Solar Max spacecraft with a grapple fixture that would allow it to be grabbed by the Shuttle robotic arm and components that could be changed out. Solar Max suffered equipment failures a few months after launch, and in a major test of Shuttle-based satellite servicing, STS-41C astronauts flew aboard Challenger in April 1984 to attempt repair work on the troubled satellite. Astronauts George Nelson and James van Hoften used an MMU to catch the satellite, but when a capture tool they carried failed, Solar Max began to spin out of control. Two days later, controllers stabilized Solar Max, and the Shuttle robotic arm grappled it and placed it in a cradle for servicing. The next day Nelson and van Hoften successfully changed out one of Solar Max's attitude control modules and replaced an electronics box. Despite its ultimate success, the flight underlined the difficulties of working in open space for astronauts and their trainers at JSC. On other flights in those years, Shuttle astronauts rescued and repaired wayward communications satellites and tested repair and construction techniques inside the Shuttle payload bay. Often, they found that the work was tougher than anticipated, usually when the equipment the astronauts took with them did not fit properly because it had not been tested on the actual spacecraft. The handling equipment had been based on engineering drawings.³⁰

After the Challenger disaster and the cancellation of planned Shuttle flights including the HST deployment mission, McCandless was assigned to continue working on HST, while Sullivan did what she could to help amidst other assignments until the deployment crew was reformed in 1988. The long delays for that flight gave both astronauts plenty of time to learn about HST while it remained on the ground. They worked with a team from Lockheed headed by Ronald L. Sheffield, a retired Army helicopter pilot whose experience of three combat tours in Vietnam left him with what Sullivan described as the steely determination and easygoing temperament needed for his second career as Lockheed's EVA Manager for the HST servicing missions. The Neutral Buoyancy Simulator at Marshall had been fitted with high fidelity training mockups, and Sullivan

and McCandless were able to practice work that astronauts would do on HST and give NASA time estimates for this work. “The preliminary reliability assessments indicated that it would take at least four EVAs to accomplish all the tasks that were likely to be slated on a typical maintenance mission,” Sullivan wrote, twice as many as the Shuttle could support at the time.³¹ Together the astronauts and the maintenance and repair team did a top-to-bottom inspection of Hubble in its cleanroom at Lockheed in Sunnyvale, California, assessing HST systems in terms of whether they could be repaired or replaced by astronauts wearing spacesuits. Alterations included modest ideas, such as putting labels on connectors inside HST to assist astronauts, and a major change to the Power Control Unit at the heart of HST. The unit was attached to a wall and would be nearly impossible to access during a servicing mission. With great difficulty, Sullivan, McCandless, Sheffield, and their team persuaded managers at Lockheed and Marshall to attach the unit to an adapter plate to make replacing the unit merely difficult. As well, the two astronauts tested tools and procedures that would be needed to repair HST. Along with McCandless, Sullivan said she “took basically every single Hubble tool out to the flight vehicle” and tested “every single fastener and every single fitting.” These preparations for STS-31, including the creation of designs for the carrier pallets for replacement units for HST, handling aids, tools and toolbox designs, and a set of EVA procedures, marked the beginning of work on servicing HST. During the deployment mission on STS-31 in April 1990, the two astronauts almost put their preparations to work after problems developed when a solar array didn’t unfurl at first. After the mission, McCandless put his expertise on HST servicing to work on the Strategies Panel for HST, as noted above.³²

The handover of responsibility for HST from Marshall to Goddard in 1990 brought a group of people from Goddard fully into the preparations for the first servicing mission to HST, joining the staff already working on the problem from JSC and Lockheed and replacing the staff from Marshall. The Goddard group, which had long been interested in servicing satellites, was headed by Frank J. Cepollina, then a leading engineer in Goddard’s systems division. A native of northern California, Cepollina, known widely as Cepi, had joined NASA Goddard in 1963 and worked on the Orbiting Solar Observatory and Orbiting Astronomical Observatory programs. As NASA began organizing the Space Shuttle Program in 1969, many NASA managers hoped that a reusable spacecraft like the Shuttle could dramatically lower the cost of space travel. Satellites designed for easy replacement of components and systems by visiting astronauts appeared to be one way of saving money. While the concept did not win universal acceptance, Cepollina championed low cost robotic spacecraft

with systems built into modules for easy servicing. In 1975, Cepollina wrote about servicing satellites using the Space Shuttle Remote Manipulator System, the robotic arm then under development in Canada, along with equipment inside the Shuttle payload bay to store replacement modules for satellites, and a cradle to hold satellites while they were being serviced. Cepollina and his group had already been working on preparing HST's instruments for changeout in servicing missions and building the Flight Support System where HST would sit in the payload bay during repairs.



▲ Frank Cepollina, who led NASA Goddard's satellite servicing effort for 35 years, in 2018.
(NASA/W. Hrybyk)

Preparations for Servicing Mission 1 (SM1) took on whole new dimensions once HST was launched, its unanticipated problems began to mount, and NASA grappled with the need for at least four EVAs on that flight. Besides the mirror, HST was also troubled by the solar array's jitters, which reduced the time available for HST to make observations, and ate up computing capacity on the spacecraft due to the need for software designed to reduce the effects of the oscillations. Goddard and contractor managers debated options for replacing the solar arrays in 1990 and 1991. Although one option was purchasing fixed solar arrays from Lockheed, NASA and ESA opted to install new ESA-provided arrays from British Aerospace, the makers of the original set. There were other problems on Hubble too. One of HST's six gyroscopes failed in December 1990 and a second failed the following June. One of the HST onboard computer's six memory units failed in May 1991, and in July the Goddard High Resolution Spectrograph developed a problem in its power supply. That summer, there was talk of splitting the work between two missions, with one flying early to deal with the more urgent problems. At a meeting at Goddard in August, tight budgets affecting NASA and HST raised fears that such an early mission would lead to temporary interruptions in HST operations or the loss of upcoming new instruments for the telescope.³³

Tight budgets had been a fact of life while HST was being built, and they would continue during Hubble's operational life. One of the biggest stories of 1990 in American politics was the federal budget. Concern was growing that year about the size of the budget deficit, and President George H. W. Bush was caught between his 1988 campaign pledge of "no new taxes" and a Democratic Congress that wanted to increase revenues to reduce the deficit. In late June, Bush got budget cuts in exchange for a tax increase in a deal with Congress. NASA's budget was increased for the upcoming fiscal year, but significantly less than what the Bush administration had proposed. The Administration's ambitious plans to return astronauts to the Moon and then on to Mars received no funds, but growing costs for the Space Station Program and the Shuttle, including the construction of the Shuttle Endeavour, meant funds remained tight elsewhere inside NASA.³⁴

Wide Field Planetary Camera 2 (WFPC2)

Time on HST:

6 December 1993–14 May 2009

Contractor:

Jet Propulsion Laboratory

Principal Investigator:

John Trauger (JPL)

Weight:

281 kilograms
(619 pounds)

Radial Instrument

Wide Field and Planetary Camera 2

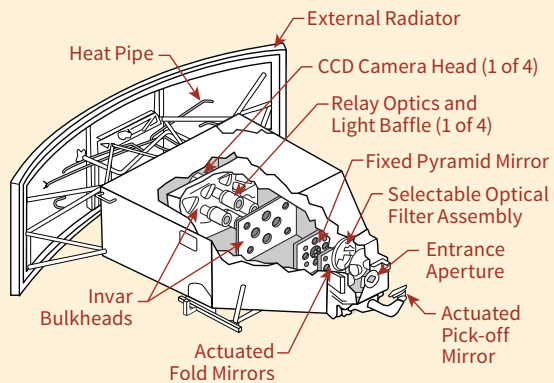

This instrument was originally intended to be a "clone" of the original Wide Field/Planetary Camera with improved components, but when HST's main mirror was discovered to be defective, NASA decided to build and launch the second WFPC with modified adjustable internal mirrors to correct spherical aberration.

BUILDING WFPC2

Scientists and engineers at JPL under Trauger and Project Manager Larry Simmons turned quickly to the task of modifying WFPC2 to counteract the effects of HST's spherical aberration. Weiler had originally nicknamed WFPC2 the “clone” to emphasize its planned similarity to WF/PC, but Weiler's nickname went by the wayside because of the changes needed to correct HST's mirror problem. WF/PC had eight CCDs—four for the wide field camera and four for the planetary camera—and that was the plan for its successor. But to bring WFPC2 in on time for the servicing mission and within budget, four of the CCDs were sacrificed in the fall of 1991. Three of the CCDs kept in WFPC2 were f/12.9 wide field systems, while the fourth, covering a field less than one quarter the size of each of the other three CCDs but at greater resolution, was the f/28.3 planetary camera system. One result of this decision was the famous

For a number of reasons, including complexity and cost issues, Hubble management decided to reduce the number of CCDs in WFPC2 to four from the eight that were in WF/PC. This meant that only one of the four CCDs was a high-resolution f/28.3 planetary CCD with a narrow field of view, and the other three CCDs were wider field f/12.9 cameras. The four CCDs together produced the distinctive chevron shape of WFPC2 images. The fact that there are not separate planetary and wide field modes as in the first WF/PC caused the slash to be removed from WFPC2's acronym.

The CCDs in the new instrument were 800 by 800-pixel Loral CCDs that had similar resolutions to their WF/PC predecessors but generally improved operating characteristics, including better efficiency. WFPC2 had 48 different filters in 12 filter wheels.^a Like its predecessor, WFPC2 images light in wavelengths of 1,150 to 10,500 angstroms, covering visible, ultraviolet, and near-infrared parts of the spectrum.

WFPC2 became the workhorse camera for HST for its early years on orbit, producing iconic Hubble images such as the marks left by Comet Shoemaker-Levy 9 on Jupiter, the “Pillars of Creation” image, the first “Hubble Deep Field,” and many others relating to important HST scientific discoveries.

WFPC2 is now on display at the National Air and Space Museum in Washington, DC.

^a STScI, *Wide Field and Planetary Camera 2 Instrument Handbook, Version 10.0* (Baltimore, MD: STScI, August 2008).

L-shape to images that were created when all four of WFPC2's CCDs were mosaicked to capture a single image. These images, whose shapes were frequently compared to a batwing, chevron, stair step, or stealth bomber, became an iconic symbol of HST. WFPC2 required new mirrors inside it, similar to the mirrors contained in COSTAR, to reverse the effects of the spherical aberration in HST's main mirror. Because of the painstaking, precise, and highly complex optical prescriptions for these coin-sized mirrors, all of them were manufactured by a highly specialized company in the suburbs of San Francisco called Tinsley Laboratories. As a result of concerns about slight movements that had taken place inside the original WF/PC during flight, WFPC2 was equipped with adjustable mirrors. This feature had the added benefit of providing further assurance that HST's extremely tight optical alignment tolerances could be met. The cost and added complexity of the actuators that made these mirrors adjustable was a major reason for the decision to reduce the CCD systems from eight to four. The mechanisms needed to make those mirror adjustments were created by JPL and Litton Itek Optical Systems.³⁵

BUILDING COSTAR

After NASA management approved the concept of COSTAR, Ball Aerospace of Boulder, Colorado, began initial detailed design work, receiving a first contract in February 1991 and a final contract in October. Ball opted to build an all-new COSTAR because the STAR unit was thought to be more useful on the ground as a template for new instruments. Only the name derived from STAR lived on in COSTAR. There were several reasons why Ball won the job without a competition. Ball had a long relationship with Goddard going back to subcontracting work on Explorer 6 in 1959, and it built the GHRS as part of the original suite of instruments for Hubble. By 1990, Ball was also working on Hubble's two second-generation spectroscopic instruments, the Space Telescope Imaging Spectrograph (STIS) and the Near Infrared Camera and Multi-Object Spectrometer (NICMOS), which were slated for installation during the second HST servicing mission in 1996 or 1997. Bottema, the Ball optical expert who had to come out of retirement to work on COSTAR, credited the fact that "I invented the optics" for Ball winning the job, along with Ball's work on the new instruments and its possession of test facilities for HST instruments.³⁶

The team at Ball, along with Principal Investigator Ford, STSci Team Leader Crocker, and Paul Geithner, the COSTAR Project Manager at Goddard, faced big challenges devising an instrument that would precisely place 10 mirrors varying in size between a dime and a quarter at precise positions along the five light paths between HST's optics and three instruments: the Goddard High

Resolution Spectrograph, which received its light in one path, and the Faint Object Spectrograph and the Faint Object Camera, which each had two light paths from the main mirrors to accommodate different operational modes in each instrument. Once COSTAR was installed inside HST, COSTAR's optical bench would extend and five beryllium arms would deploy with their mirrors in the very cramped space inside the telescope's focal plane. The arms were designed to retract when instruments using COSTAR were changed out in future servicing missions. As with WFPC2, the tiny mirrors going into COSTAR were adjustable to meet the extremely tight optical tolerances of the instruments. Tinsley Laboratories did the highly specialized work of creating the tiny mirrors, which required a special coating for better performance in ultraviolet light. Getting COSTAR and its 5,300 moving parts ready involved long hours of work for the people at Ball, STScI, and NASA, who were challenged with problems such as the mirrors rubbing against each other during vibration testing and contamination from glue used to hold parts together.³⁷

NASA didn't publicize cost figures for WFPC2 because it was already in the HST budget before the HST mirror problem was discovered. NASA estimated the price of COSTAR at \$50 million. Officially, this money was found by rearranging priorities within the HST budget, but Fisk later said most of that money was taken from another NASA science program.³⁸

Given the high profile and cost of HST, NASA could not take chances with the repairs to the space telescope. Memories of the troubled repairs of Solar Max and other satellites caused by relying only on photos or plans to design repair tools were still fresh around NASA. As Cepollina put it: "We had to get it right. We couldn't screw up Hubble."³⁹ To make sure that the new optics would work, JPL and Ball built simulators and test equipment to verify WFPC2 and COSTAR. NASA also used virtual reality techniques to make sure the instruments and COSTAR's deployable optics fit properly. Two simulators were built at Goddard to test the new instruments, including the Vehicle Electrical Test Facility (VEST), which was a full electrical representation of HST on the ground. Interface tests of all new instruments and other hardware were conducted on the VEST before servicing missions, and the facility has continued to operate throughout HST's lifetime to help troubleshoot problems on HST and verify new software and procedures before they are put into use. NASA and Ball personnel created the High Fidelity Mechanical Simulator to ensure that WFPC2 and COSTAR would fit properly in Hubble, and it was also used to help familiarize astronauts with the work of installing these instruments.⁴⁰

With progress in 1991 on developing both WFPC2 and COSTAR, Joe Rothenberg and other managers turned their attention in early 1992 to the

servicing mission, which was then scheduled for November or December 1993. While Shuttle crews were usually named about a year before flight, Rothenberg put pressure on JSC management to name the servicing crew sooner. In March 1992, JSC chose the first astronaut for the servicing mission, the person who would serve as payload commander with onboard responsibility for the EVAs. Story Musgrave had the most varied background of any member of the NASA astronaut corps, including experience in the U.S. Marines as a mechanic and electrician, thousands of hours flying time in many different types of aircraft, and work as a trauma surgeon. He earned degrees in mathematics and statistics, business administration, computer programming, chemistry, literature, medicine, and physiology. As an astronaut, Musgrave quickly specialized in EVAs, helping prepare the space walks on Skylab and then developing EVA equipment and procedures for Shuttle prior to his first flight and first EVA on STS-6. Prior to his assignment to SMI, Musgrave flew three further Shuttle

Corrective Optics Space Telescope Axial Replacement (COSTAR)

Time on HST:

7 December 1993–16 May 2009

Contractor:

Ball Aerospace

Principal Investigator:

Holland Ford
(Johns Hopkins University)

Weight: 290 kilograms

(640 pounds)

Axial Instrument

Corrective Optics Space Telescope Axial Replacement

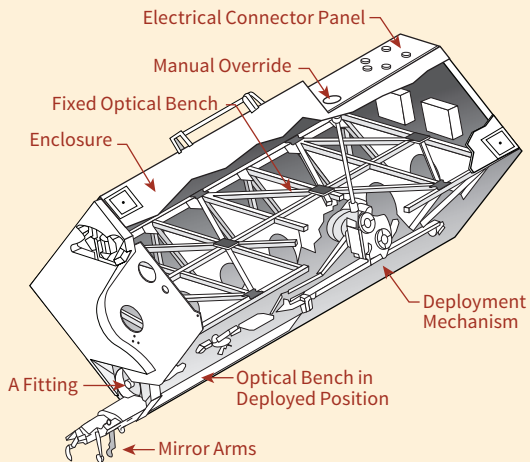

After HST's main mirror was found in 1990 to be ground to the wrong shape, causing spherical aberration, NASA approved the proposal of the STScI Strategy Panel that the COSTAR be built with five arms reaching into the light path between HST's optics

flights and served as spacecraft communicator on other flights, including STS-31, the HST deployment flight. Shortly after Musgrave's assignment to SM1, the Shuttle Endeavour launched on its first mission, STS-49, with the goal of retrieving the Intelsat VI communications satellite from low-Earth orbit and attaching it to a rocket motor that would loft it into its originally intended geosynchronous orbit. In problems eerily reminiscent of those encountered in the Solar Max repair mission and two other Shuttle missions in 1984 and 1985, astronaut Pierre Thuot repeatedly tried and failed during two space walks to capture Intelsat VI with a specially developed capture bar. Two days later, Thuot and two other astronauts grabbed the wayward satellite by hand and succeeded in attaching it to a rocket motor that sent it on its way to its proper orbit. The daring and unprecedented three-person EVA was chalked up in public as a triumph because the satellite rescue ultimately succeeded. But it was clear that NASA still faced big problems with EVAs. That message was driven

and three other axial instruments. COSTAR could not work for the radial instruments such as WF/PC, WFPC2, or the Fine Guidance Sensors.^a

Once COSTAR was installed inside HST on Servicing Mission 1, the five arms were extended, placing 10 coin-sized mirrors into the light paths leading to the Goddard High Resolution Spectrograph, the Faint Object Spectrograph, and the Faint Object Camera. As FOS and GHRS were removed during Servicing Mission 2 in 1997 and FOC in Servicing Mission 3B in 2002, the arms relating to each instrument were retracted. Newer instruments were engineered with internal mirrors to compensate for the defects in HST's main mirror and hence did not require COSTAR.

No scientific work was carried out from COSTAR, though it enabled a large quantity of science to be done with the FOC, FOS, and GHRS, whose light input it corrected. After nine years of operation and nearly seven years of not being used, COSTAR was removed during Servicing Mission 4.

COSTAR is now on display at the National Air and Space Museum in Washington, DC.

^a NASA Facts, "Corrective Optics Space Telescope Axial Replacement (COSTAR)," Goddard Space Flight Center, June 1993; Ball Corporation, *Technology Update: Corrective Optics Space Telescope Axial Replacement (COSTAR)*, undated.

home during STS-49's final spacewalk, when astronauts Kathryn C. Thornton and Thomas D. Akers ran into problems while testing techniques needed to assemble the Space Station.⁴¹

ENTER DAN GOLDIN

The spring of 1992 also saw major changes at the top level of NASA. The administration of President George H. W. Bush had grown dissatisfied the year before with NASA Administrator Admiral Richard H. Truly, a former astronaut, mainly over differences that led to the failure of the Administration's Space Exploration Initiative. The problems with Hubble, continuing Shuttle issues, an embarrassing antenna problem that hobbled the Galileo spacecraft headed to Jupiter, and concerns about the Space Station Program all contributed to Truly's resignation in February 1992 at the request of the President. By the time Truly left at the end of March, Congress had confirmed Bush's selection of Daniel S. Goldin, an engineer who had worked for many years in classified space programs at TRW after a brief stint at NASA.⁴² During his confirmation hearings, he heard from senators such as Mikulski and, most memorably, from Ernest "Fritz" Hollings (D-North Carolina) who said, "Mr. Goldin, do you know that the Hubble is blind? The Galileo spacecraft is deaf, the Shuttle is grounded, the Space Station spent its whole budget and has no hardware to show for it? It's not on orbit. The weather satellites, which are crucial to my state, are dead. We have no way of getting warning for hurricanes. NASA has no vision and it's out of touch."⁴³

The new Administrator quickly shook up the leading personnel in the Agency. After Bush lost the 1992 election to the Democratic candidate, William J. Clinton, the new president opted to retain Goldin as NASA Administrator. Although Goldin had many issues to deal with, including major changes to the Space Station Program amidst growing opposition within Congress, he sent word to those working on HST at Goddard that his telephone line was open to them. "It must work," he said of the repair plans.⁴⁴

Goldin recalled later that he took personal responsibility for the success of the servicing mission and the safety of the crew, stating, "My operating style is to ask a lot of very difficult questions to cause people to think. And to bring in people who aren't personally responsible for conducting the mission, if you will, red teams. The blue teams are the people that are on the mission. The red team doesn't have personal responsibility for the mission, so they can ask whatever they want, and they don't have to be defensive."⁴⁵ To that end, Goldin set up a task force looking into satellite rescue and repair, followed a few months later by another task force headed by former Apollo program manager Joseph Shea

to review plans for SM1. In the months leading up to the mission, other review groups proliferated at Johnson, including a team headed by engineer Richard Fitts and others involving former astronauts John W. Young and Joseph P. Allen. Another review team headed by former Gemini and Apollo astronaut General Thomas Stafford pressed JSC to quickly name the crew for SM1.⁴⁶

In August, NASA responded by naming Akers and Thornton, fresh off spacewalks on STS-49, and Jeffrey A. Hoffman, an astrophysicist and three-time Shuttle veteran with spacewalk experience, to the servicing mission, now designated as STS-61 on Endeavour. In December, the all-veteran crew was filled out with Richard O. Covey taking the commander's seat, Kenneth D. Bowersox as

pilot, and Swiss ESA astronaut and astrophysicist Claude Nicollier as mission specialist responsible for operating the Shuttle's robotic arm after having done the job on a previous mission. The lead flight director for the mission, J. Milton Hefflin, was also experienced at that position. In a first for a Shuttle flight made at Goldin's direction, the Agency named a Mission Director for STS-61 with overall responsibility for mission success. Randy Brinkley, a former Marine Corps aviator, reported to NASA Headquarters but worked at Johnson Space Center.⁴⁷

ELABORATE PREPARATIONS

Long before launch, Musgrave and his STS-61 colleagues became well known for their dedication to training. In May 1993, Musgrave was fully suited for a test inside a vacuum chamber at JSC set to the low temperatures that were



▲ Daniel S. Goldin served as NASA's ninth Administrator from 1 April 1992 to 17 November 2001. (NASA: GPN-2002-000094)

expected to be encountered during HST repairs. While testing tools, Musgrave suffered from frostbite in eight fingers. He was flown to Alaska for treatment from specialists in frostbite injuries. On earlier spacewalks, Musgrave and other astronauts had faced cold temperatures in their gloves, but only for short periods. His painful lesson led to a number of improved servicing mission procedures, including redesigned gloves to maintain warmth, and changes to the orbiter attitude during EVAs to stabilize temperatures while preventing sunlight from entering the telescope while astronauts were working.⁴⁸ Musgrave and the three other astronauts who performed spacewalks in the mission spent 738 hours training in the Neutral Buoyancy Simulator at Marshall and the Weightless Environment Training Facility (WETF) at JSC. They also trained on mechanical, computer and virtual reality simulators, vacuum chambers, the Manipulator

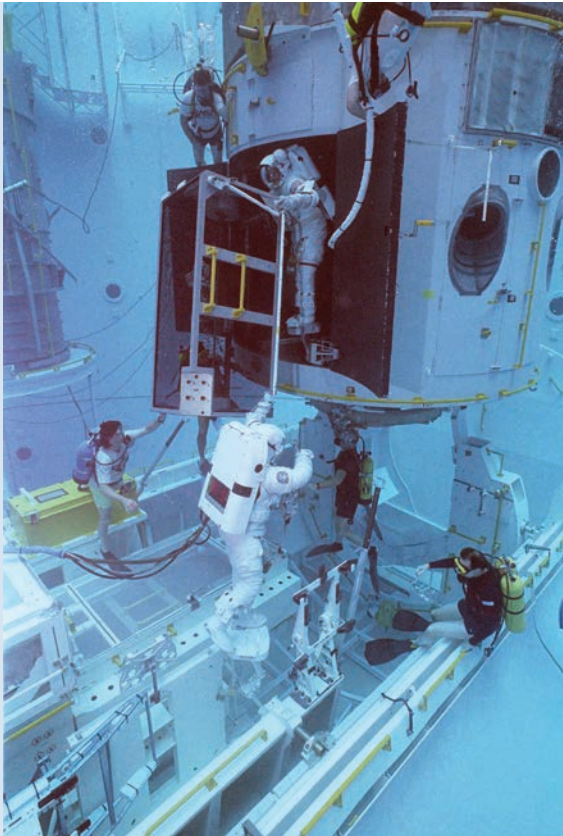

▲ Astronauts prepare for the first Hubble Space Telescope servicing mission in Marshall Space Flight Center's Neutral Buoyancy Simulator. Divers are on hand to provide assistance. (NASA: 9307457)

Development Facility at JSC which included a realistic robotic arm and balloons in the shape and size of HST, and the High Fidelity Mechanical Simulator at Goddard, where they practiced moving instruments in and out of the telescope. Musgrave compared the work of the spacewalking astronauts and the robotic arm operator to a “ballet” that required a great deal of rehearsal time. The astronauts also came in contact with the actual hardware, which involved travel around the U.S. and even to England, where the new solar arrays were made. They even spent time inspecting the only full-scale mockup of HST, the former Structural Dynamic Test Vehicle, at

the National Air and Space Museum in Washington, DC. These rehearsals for the EVAs took place on top of the normal full-dress simulations of various phases of the flight that not only involved the astronauts but also the controllers from Johnson, along with staff from Goddard, STScI, and other contractors who would support the mission.⁴⁹

Other preparations for the servicing mission had gone back to the mid-1980s, including creating the equipment placed inside the Shuttle payload bay to hold HST in place and the instruments and tools the astronauts would use to make repairs. Located at the back of the cargo bay was the Flight Support System (FSS) maintenance platform, a U-shaped cradle topped with a circular berthing ring that attached to HST using three latches and an umbilical to provide Shuttle power to HST. The ring could rotate almost a full circle to turn the telescope toward the astronauts for easy access and could be pivoted as well. The FSS had been used for the first time on the STS-41C mission to service the Solar Maximum Mission. In front of the FSS was the Orbital Replacement Unit Carrier, a modified Spacelab pallet containing two Science Instrument Protective Enclosures, one each for COSTAR and WFPC2. The carrier also included boxes for other equipment being installed on HST, including Rate Sensor Units that contained new gyroscopes and replacement power and computer units. The Solar Array Carrier at the front end of Endeavour's payload bay was designed to hold two solar arrays and their associated electronics and bring the old solar arrays back to Earth for analysis. Both of the carrier units were designed to protect their cargo from the buffeting of launch, and included fixtures to park instruments during the EVAs. A toolbox in the payload bay contained many of the more than 200 tools and crew aids created at Goddard, Marshall, and JSC that the four STS-61 spacewalkers would use during the mission. Some tools were stored inside the Shuttle cabin. The tools included well-known articles such as power ratchet tools and smaller powered screwdrivers and torque limiters. Crew aids included portable foot restraints, handles, storage brackets, clamps, and covers to protect instruments from impact or contamination. Many of these tools and aids were specifically designed for tasks peculiar to this servicing mission.⁵⁰

To deal with budget problems facing the U.S. government in general and NASA in particular, the Agency took measures to absorb the costs of correcting Hubble's vision problem. The Shuttle flight to HST had a price tag of \$361 million, but that mission was on the flight manifest before HST was launched, and as was customary, the money for all Shuttle flights involving HST came out of NASA's budget for the Shuttle Program. NASA spent another \$251 million in 1993 dollars on the mission for instrument preparations and HST ground

operations. A NASA statement in 1993 said the Agency estimated that the correction of the optical problem cost an extra \$86.3 million, and to meet most of that cost, NICMOS, which was being built for the 1997 servicing mission, was scaled back along with WFPC2, as mentioned above. STIS was delayed to the 1997 servicing mission. Further savings were made through reductions to HST administration costs, and Goddard absorbed \$3 million in other cutbacks.⁵¹

GROWING PRESSURES

New problems developed on HST in 1992, increasing the demands on SM1. That November, a third gyro failed, leaving only three operating gyros, the minimum then allowed without reducing HST activities. At the same time, another memory unit in the flight computer failed, a power supply problem hit the Faint Object Camera, and two magnetometers developed problems. To say the least, this gave HST engineers nightmares—they had to increase the number of EVAs to the unprecedented number of five. Following a recommendation from the Stafford task force, astronaut and engineer Gregory J. Harbaugh was named as a backup crew member, something new in the Shuttle Program. Harbaugh got the job shortly after returning from Shuttle mission STS-54 in January 1993, where he and another astronaut practiced spacewalking procedures that would be required for the servicing mission. Other astronauts also tested EVA techniques and tools needed for SM1 during the flights of STS-57 in June 1993 and STS-51 in September.⁵²

The year 1993 turned out to be one of most difficult in the history of NASA, boosting the pressure on the servicing mission scheduled for December. The incoming Clinton administration critically examined the troubled Space Station Program as Goldin struggled to save it and decided in June to continue with the station in a reduced form. On 23 June, the House of Representatives came within one vote of cancelling the Space Station. To save the situation later that year, the administration brought Russia on board and rebranded the program as the International Space Station. But there were more embarrassing problems. Shuttle missions continued to experience delays and on 21 August, the highly anticipated Mars Observer spacecraft disappeared just 3 days before it was to go into orbit around the Red Planet. The same month, a newly launched weather satellite failed, and a remote sensing satellite failed to reach orbit in October.⁵³

NASA was clearly in a jam—Goldin demanded more reviews and even an elaborate news management plan to promote the servicing mission. Months before the flight, *Science* magazine described the “high stakes” flight as a “drama of redemption” for the troubled space Agency.⁵⁴ “NASA can’t afford another highly visible failure,” political scientist John Logsdon told the *New*

York Times shortly before launch day. “If the Hubble repair is a failure, we can write off space science for the foreseeable future,” warned John Bahcall, one of the people most responsible for making HST a reality.⁵⁵ Media strained to emphasize the importance of the mission to NASA: “One small misstep by the Hubble repairmen could mean one giant leap backward for space agencykind,” said science writer Dennis Overbye.⁵⁶ A *USA Today* headline described STS-61 as “The Must-Win Mission.”⁵⁷

In the weeks before launch, there were two anxious moments during the final preparations for SM1. In September, a test of WFPC2 suggested that the camera was seriously out of focus, but the finding was traced to a problem with the testing equipment and not WFPC2, which had been verified in other tests and one final review that followed. And on October 30, sand contamination from sandblasting operations near the launch pad was found inside the payload changeout room on Pad 39A, but thankfully the contaminants did not reach critical hardware.⁵⁸

SERVICING MISSION ONE

After a one-day postponement due to poor weather conditions, STS-61 lifted off in predawn darkness at 4:27 a.m. EST from Pad 39B at Kennedy Space Center on Thursday, 2 December 1993. Over the next two days, Covey and Bowersox flew Endeavour and its crew of seven toward HST. Upon reaching the troubled telescope, Nicollier attached the Shuttle’s robotic arm to a fixture on HST and berthed the telescope on the FSS maintenance platform in Endeavour’s payload bay. For the five critical EVAs, the four spacewalkers were split into two teams: Musgrave and Hoffman were responsible for three spacewalks, and Akers and Thornton carried out two other EVAs. All four astronauts were trained to carry out every task, as was their backup, Harbaugh, who served as the spacecraft communicator in the Mission Control Center during the EVAs. The servicing work was organized to be done in order of importance, in case the mission had to be cut short. The gyroscopes, which were changed out on the first EVA, for example, were critical to pointing Hubble, and badly needed replacement. Thus, they got top priority. Although the EVAs took place in the late evening and overnight hours in North America, many people tuned in when cable systems around the U.S. carried *NASA Select* coverage of the mission.⁵⁹

Musgrave and Hoffman emerged early for the first EVA on the evening of 5 December and set to work replacing two Rate Sensing Units, each containing two gyroscopes, and two Electronic Control Units. Musgrave was able to fit inside the telescope to work on replacing the units, and the EVA went smoothly until the time came to close HST’s aft shroud doors, which needed



▶ The STS-61 crew insignia depicts the astronaut symbol superimposed against the sky with Earth underneath. Also seen are two circles representing the optical configuration of the Hubble Space Telescope. (NASA: 9311999)



▶ Astronaut Jeffrey A. Hoffman holds the Wide Field and Planetary Camera (WF/PC) after it was removed from HST in December 1993 during the first Hubble servicing mission. Both WF/PC and its replacement, the Wide Field and Planetary Camera 2 (WFPC2), were radial instruments on HST.

(NASA: 9400368)

▼ Servicing Mission 1 insignia created at the Goddard Space Flight Center. (NASA)



◀ With the Hubble Space Telescope berthed in Endeavour's cargo bay, crew members for the STS-61 mission pause for a crew portrait on the flight deck. Left to right: F. Story Musgrave, Richard O. Covey, Claude Nicollier, Jeffrey A. Hoffman, Kenneth D. Bowersox, Kathryn C. Thornton, and Thomas D. Akers. (NASA: sts061-05-031)

to be secured for the telescope to work properly. The two doors refused to line up, so finally Mission Control allowed Musgrave to use brute force to close the doors with the help of what he called a “come along,” a device using belts and clamps on the door handles to bring the doors together. The fix worked.⁶⁰

Replacing the two solar arrays was on the agenda for Akers and Thornton’s EVA the following day. When Endeavour first arrived at HST, the astronauts noted that one of the bi-stems spreading out the starboard solar array had a kink in it, and when controllers attempted to roll up the arrays after the first EVA, the starboard array would not roll up. Controllers decided to jettison the troubled array instead of bringing it home as planned. Akers detached the array while Thornton grasped it with a special handhold and held onto it until the designated moment of release just before sunrise. In one of the most dramatic moments of the mission, Thornton set the array free as Covey backed Endeavour away. The array shuddered like a prehistoric bird as the gases from the Shuttle’s thrusters blew it back and forth. The two astronauts then installed the replacement starboard array, stowed the port array for return to Earth, and installed its replacement.⁶¹

With the new gyroscopes and solar arrays in place, all attention turned to the two new instruments designed to correct Hubble’s spherical aberration. Astronauts on Shuttle flights were awoken each day with a specially selected song, and for flight day six, Mission Control chose Jackson Browne’s “Doctor My Eyes.” After suiting up, Musgrave and Hoffman began their second spacewalk by disconnecting and removing WF/PC from its position in HST’s radial instrument bay. When the two spacewalkers had stowed WF/PC on a temporary parking fixture, Hoffman, standing on the end of the Shuttle robotic arm, removed WFPC2 from its container. Musgrave carefully removed the cover protecting WFPC2’s fragile pickoff mirror, and then Hoffman maneuvered the new camera into position. The two astronauts then connected WFPC2 and prepared WF/PC for return to Earth. The process required use of specialized handholds and careful handling to move the two instruments. Musgrave and Hoffman then moved up to the top of the telescope and installed two new magnetometers. They discovered that covers on the old magnetometers were coming loose and required replacement, and soon crew members were put to work making new covers from extra insulation material onboard the Shuttle.

The next day, 7 December, Thornton and Akers started their second EVA, disconnecting, removing, and later stowing the High Speed Photometer, and installing COSTAR in its place. When controllers confirmed that the new instrument was connected, the two astronauts repaired HST’s DF-224 computer by installing a new coprocessor based on the Intel 80386 chip. “We’ve got



▲ Astronaut Kathryn C. Thornton lifts the Corrective Optics Space Telescope Axial Replacement (COSTAR) prior to its installation into the Hubble Space Telescope during the STS-61 mission. Thornton is anchored to a foot restraint on the end of the Remote Manipulator System arm. Crewmate Thomas D. Akers, assisting in the COSTAR installation, is at the lower left. (NASA: sts061-47-014)

basically a new telescope up there,” Hoffman said shortly after the spacewalk. “It can be really exciting for the astronomical community, I guess, the whole world, to see what Hubble can really do with a good set of eyeballs.” Shortly after the EVA, Covey and Bowersox fired Endeavour’s forward thrusters for 61 seconds to raise HST’s orbit to an altitude of 369 statute miles (593 kilometers). On 8 December, Musgrave and Hoffman installed new solar array drive electronics and a relay box for the Goddard High Resolution Spectrograph’s erratic power supply, and they had to swing out a solar array that would not move from its stowed position. The spacewalk reached a high note when the two astronauts rode the robotic arm to the top of HST to install the new makeshift covers for the magnetometers. The fifth and final EVA of the mission ended after the new solar panels unrolled. Finally, on 9 December, Nicollier raised HST above the payload bay with the robotic arm and released it. Endeavour and its jubilant crew landed at KSC early on 13 December.⁶²

Even before the seven astronauts got back to Earth, political leaders including President Clinton, Vice President Gore, and many in Congress praised them, saying that their success breathed new life into the Space Station Program. “The restoration of confidence in NASA’s ability to plan and manage such tasks will make my job of lobbying for a stable space budget much easier,” proclaimed Representative George E. Brown (D-California), chair of the House Committee on Science, Space, and Technology. Gore, who as a senator had been critical of NASA when the spherical aberration was discovered, called the servicing mission “a symbol of NASA on the way back.”⁶³ The media joined in on the praise. The *Washington Post* called the mission a “spectacular” event that “showed American genius at work.” The *New York Times* said that the “near-flawless performance by the Endeavour astronauts in the most complex repair job yet attempted in orbit” has increased hope that astronauts “will be able to carry out the far more complex and arduous job of assembling a Space Station.”⁶⁴ On top of the many honors that came their way, the crew of STS-61 soon appeared in an episode of one of the highest rated comedy shows of the day, *Home Improvement*.⁶⁵

Amidst the media praise that punctuated the completion of STS-61, the biggest question still lingered: had the repairs actually improved Hubble’s vision? For the astronomers who worked on the fixes, the answer began to emerge five days later. At about 1:00 a.m. on 18 December, a group of astronomers from NASA and STScI gathered around a monitor at the Institute to see the first image from WFPC2. The image showed a bright star named AGK+81°266 in clear focus without the artifacts of spherical aberration, and the astronomers cheered. Christopher Burrows didn’t stay to celebrate though. After shaking hands with Ed Weiler, Burrows went to his office and thoroughly analyzed the image before he too felt relief, saying, “We knew at that point



Wide Field/Planetary Camera



Wide Field Planetary Camera 2

▲ Images of the nucleus of galaxy M100. The top image was taken by WF/PC in November 1993 before it was replaced by the WFPC2 camera in December 1993. The bottom image was taken with WFPC2 on 31 December 1993. WFPC2 was designed to compensate for the spherical aberration in HST’s main mirror. (NASA/STScI: STScI Release 94-01)

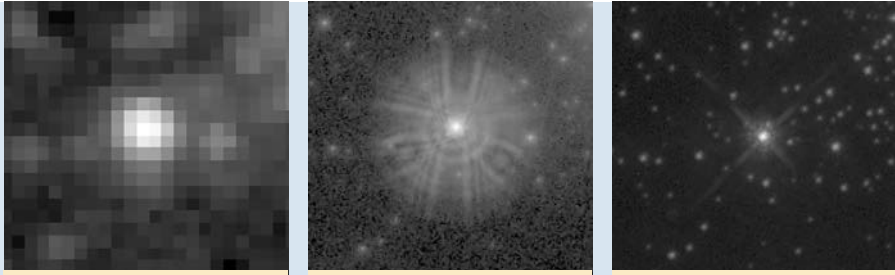

Ground image at 0.6 arcsec resolution

WF/PC image (before servicing)

WFPC2 image (after servicing)

▲ Images of Melnick 34 in the Large Magellanic Cloud in the star forming region 30 Doradus. The image at the left was taken with a ground-based telescope. The center image was taken by WF/PC and shows the effects of spherical aberration in HST's main mirror. The image at right was taken by WFPC2, which compensates for the defect in HST's mirror.

(NASA/STScI: STScI Release 94-05)

it was pretty much fixed.”⁶⁶ But there was still the matter of COSTAR, which was the “fix” for HST’s other three instruments. On 26 December, John Wood recorded in his notes, “COSTAR Moved OK!” The arms holding the COSTAR mirrors had moved correctly into place in the light paths of GHRS, FOS and FOC, and two days later, he recorded that observations had been successfully made using COSTAR and the two spectrographs inside HST.⁶⁷

At the time of the servicing mission, NASA had warned the media and the public that it could take up to 13 weeks to adjust the new instruments and verify the full function of HST after the mission. Important results of astronomical work are often announced at meetings of the American Astronomical Society, and a major AAS meeting was scheduled for mid-January in Arlington,

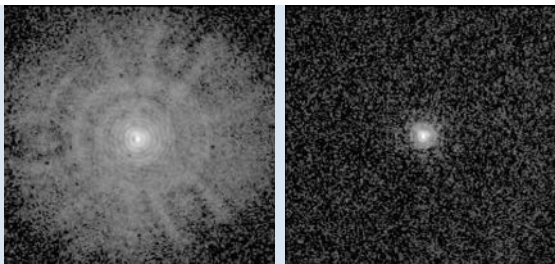

Before COSTAR

After COSTAR

▲ The COSTAR instrument cleared up the effects of spherical aberration for three other HST instruments. These before and after shots from the ESA Faint Object Camera released in January 1994 show the effects of COSTAR's installation. (NASA/STScI/ESA:

STScI Release 94-08)

Virginia, which was well inside the time that NASA expected to still be testing the new instruments. But the first images were so good, even with an unadjusted instrument and with the CCDs not cooled down, that NASA and members of the instrument teams decided to press after a short Christmas break for an early release of images using WFPC2, and FOC

with an assist from COSTAR.⁶⁸ The rapid restoration of HST was kept quiet until 12 January, when NASA announced a press conference for the next day at Goddard to coincide with the AAS meeting. The presence of Goldin at the press event telegraphed that the news was good. The next day, Goldin told a packed news conference that the HST was operating beyond original specifications. “We are a can-do Agency,” the exultant NASA administrator added. Said Weiler, who had delivered the bad news about HST in the same place three and a half years earlier, “It’s fixed beyond our wildest expectations.” NASA released dramatically clear images of the galaxy M100, complete with a blurry view taken before the repairs for comparison, along with sharp new images from inside the 30 Doradus nebula, and Nova Cygni 1992. More images were released at the AAS meeting, including the Great Nebula in Orion, the Eta Carinae star system, and Supernova 1987A. Senator Barbara Mikulski, summed up the event saying, “The trouble with Hubble is over.”⁶⁹

CONCLUSION

Fine tuning of Hubble’s optics and instruments continued into 1994, but the bottom line for astronomers was that HST had its vision restored and was producing images at the diffraction limit. The success of HST Servicing Mission 1 and the new instruments installed in the telescope literally saved and advanced the art of satellite and spacecraft servicing in orbit. The mission showed the importance of thorough preparation for servicing Hubble, which involved far more complex work than had been previously done in space. For Johnson Space Center, which had responsibility for the Space Station Program, the mission was probably more important in terms of preparing its engineers and astronauts for the challenges of assembling the Station on orbit. The STS-61 Mission Director’s Post-Mission Report contained many recommendations for upcoming missions to the Station as well as future HST servicing missions. Many people involved with the mission, including Mission Director Randy Brinkley and lead Flight Director Milt Heflin, went on to work in the Space Station Program. As shown by media praise previously quoted, STS-61 restored confidence that NASA had the capability to carry off its ambitious plans for the station.⁷⁰

The story of Servicing Mission 1, COSTAR, and WFPC2 has become an integral part of the lore around the Hubble Space Telescope. The creation of COSTAR proved irresistible for writers and documentary producers, many of whom emphasized the story of COSTAR at the expense of WFPC2. A 2015 Public Broadcasting Service *Nova* documentary, “Invisible Universe Revealed,” drew a complaint from Weiler for not mentioning WFPC2. John Trauger, asserted that in spite of the scientific importance of restoring the Faint Object

Camera and the two spectrographs with COSTAR, it was WFPC2's images that proved to the public that HST had been restored. He called WFPC2 "The Camera That Saved Hubble."⁷¹ In the first two full observing cycles after the servicing mission, WFPC2 was used for roughly half the available time on HST, and the three other instruments reliant on COSTAR, especially FOS and GHRS, were used for the other half of the time.⁷² The fact of the matter was that HST needed both WFPC2 and COSTAR to restore both the confidence of taxpayers, who had been promised amazing images from HST's cameras, and scientists, who needed both the images and data coming from HST's other instruments to increase their knowledge of the universe. There was no single solution to HST's spherical aberration problem, and it took both instruments installed during STS-61 to give the public and scientists the solutions they wanted.

No one at NASA or STScI who went through the experience of HST's vision problems would care to repeat the experience. Before HST was launched, the relationship between NASA and the Institute was best described as troubled due to differences over the respective roles of the space Agency and the Space Telescope Science Institute in running HST. Thanks to the efforts of many people at NASA, STScI, and many other contractors big and small who had overcome difficult technical problems and hostility from angry politicians and taxpayers, HST was restored along with many working relationships within the program. By 1994, Hubble had a "badge-less team," in the words of Ed Weiler, referring to the identification tags that distinguished people from various NASA Centers such as Goddard, Johnson, and NASA contractors said, "Everybody else was against you. You had to come together. And we came together."⁷³

ENDNOTES

- 1 Weiler OHI, p. 4; Transcript, "Status Briefing," 27 June 1990, NASA HRC.
- 2 Weiler OHI, p. 6; Transcript, "Status Briefing," 27 June 1990"; NASA HRC; Faber notebook, p. 34.
- 3 Edward J. Weiler, "Space Telescope Scientific Instruments Maintenance and Refurbishment," memo, NASA Headquarters, 18 December 1983.
- 4 John Trauger, "Wide Field and Planetary Camera 2: 'The Camera that Saved Hubble,'" undated memoir; John Trauger, oral history interview by author, 3 October 2016; William Harwood, "Fixing Hubble's Blurry Vision," *Spaceflight Now* (23 April 2015), <https://spaceflightnow.com/2015/04/23/fixing-hubbles-blurry-vision> (accessed 2 February 2017); Transcript, "HST, Status Briefing, June 27, 1990." Aden Meinel had taken a prominent role in promoting large space telescopes back in the 1950s and 1960s. See Smith, *The Space Telescope*, pp. 53–54.

- 5 The other members of the Board were Roger Angel, professor of astronomy at the University of Arizona; John D. Mangus, Head of the Optics Branch at Goddard Space Flight Center; George A. Rodney, NASA Associate Administrator for Safety and Mission Quality; Robert R. Shannon, Director of the Optical Sciences Center at the University of Arizona; and Charles P. Spoelhof, a retired vice president of the Eastman Kodak Company.
- 6 Lew Allen, ed., *The Hubble Space Telescope Optical Systems Failure Report* (Washington, DC: NASA TM-103443, 1990). See also Smith, *The Space Telescope*, pp. 409–414. The sequence of events that led to the error is described in chapter one.
- 7 See Duncan T. Moore, ed., *Final Report: Hubble Independent Optical Review Panel* (Greenbelt, MD: Goddard Space Flight Center, P-442-0078, 1991). The mirror's conic constant should have been -1.0023.
- 8 NASA Office of Inspector General, "NASA OIG Report of Investigation: Hubble Space Telescope, Hughes Danbury Optical Systems Inc." (I-GO-90-259, 8 January 1991); "U.S. Seeks Payment for Hubble Flaw," *Washington Post* (19 October 1992): A7; U.S. Department of Justice News Release, "Settlement Reached Over Flaw in Hubble Space Telescope," 4 October 1993, with attached draft settlement agreement.
- 9 David Leckrone, oral history interview by author, 5 May 2015, p. 18; Fisk, comments at HST 25th anniversary panel.
- 10 Joseph Rothenberg, oral history interview by author, 27 September 2016, pp. 13–7; Joseph N. Tatarewicz, "The Hubble Space Telescope Servicing Mission," chapter sixteen in Pamela E. Mack, ed., *From Engineering Science to Big Science: The NACA and NASA Collier Trophy Research Project Winners* (Washington, DC: NASA History Office, 1998), p. 375.
- 11 Boggess OHI, p. 8; Smith, *The Space Telescope*, pp. 421–425.
- 12 "Heaven Can Wait," *Newsweek* (9 July 1990): 51–53; Smith, *The Space Telescope*, p. 421.
- 13 Holland Ford, oral history interview by author, 27 October 2015, pp. 6–10; Robert Brown, oral history interview by author, 14 December 2016, pp. 3–5; Robert A. Brown and Holland C. Ford, eds., *Report of the Hubble Space Telescope Strategy Panel: A Strategy for Recovery: Results of a Special Study August–October 1990* (Baltimore, MD: Space Telescope Science Institute, 1991).
- 14 R. A. Brown and H. C. Ford, eds., *Report of The HST Strategy Panel: A Strategy for Recovery*, p. 2.
- 15 James Crocker, oral history interview by author, 21 September 2015, pp. 9–16; Brown, interview, p. 5; Robert Zimmerman, *The Universe in a Mirror: The Saga of the Hubble Space Telescope and the Visionaries Who Built It* (Princeton: Princeton University Press, 2008), pp. 149–150.
- 16 Crocker OHI, pp. 12–13.
- 17 Crocker OHI, pp. 9–16; Joseph Rothenberg, e-mail to author, 22 February 2017; Tatarewicz, "HST Servicing Mission," p. 376; John Troeltzsch, e-mail to author, 18 April 2017; Richard A. White and Elizabeth Austin, "Space Telescope Axial Replacement Procurement," memo for record, Goddard Space Flight Center, Greenbelt, MD, 14 March 1985.
- 18 Leckrone OHI, pp. 14–16; Ford OHI, pp. 8–10; Crocker OHI, pp. 11–12; Tatarewicz, "HST Servicing Mission," p. 365.

- 19 Patricia “Padi” Boyd, oral history interview by author, 13 June 2016, pp. 3–5; Leckrone, OHI, pp. 14–16; James M. Lattis, *A Hubble Instrument Comes Home: UW Madison’s High Speed Photometer*, 2012, <https://spacegrant.carthage.edu/ojs/index.php/wsc/article/download/27/27/1/PB.pdf> (downloaded 18 February 2017). David Leckrone credits astronomer Olivia Lupie, who later went on to become HST Instrument Systems Manager at GSFC, with sharing information obtained by the High Speed Photometer on the HST instrument apertures for use with COSTAR.
- 20 Brown and Ford, *Report of the HST Strategy Panel*, p. 2; Crocker OHI, pp. 15–16; Pellerin OHI, pp. 34–38; Rothenberg OHI, pp. 17–19. After overseeing a shakeup of HST management and facilitating NASA’s work on COSTAR and WFPC2, Pellerin moved to another position at NASA.
- 21 Michael Ollove, “Institute Optimistic Despite Hubble Woes,” *The Baltimore Sun* (28 June 1990): A1.
- 22 *Hubble Space Telescope and the Space Shuttle Problems*, Senate hearing, 29 June 1990, p. 19; House hearing, 13 July 1990, pp. 113–116.
- 23 STScI, “Space Telescope Photographs Extragalactical Stellar Nursery,” news release STScI-1990-09, 13 August 1990; Kathy Sawyer, “Hubble Discovers Star Group,” *Washington Post* (14 August 1990): A3; Sally Heap, oral history interview by author, 22 May 2015, pp. 7–10; Eliot M. Malumuth and Sara R. Heap, “UBV Stellar Photometry of the 30 Doradus Region of the Large Magellanic Cloud With the Hubble Space Telescope,” *The Astronomical Journal*, 107, no. 3 (March 1994): pp. 1054–1066. HST would image 30 Doradus, also known as the Tarantula Nebula, several times during its mission.
- 24 Chaisson, *The Hubble Wars*, pp. 214–220; Ray Villard, oral history interview by author, 30 October 2015, pp. 11–13; “Conversations: With John Bahcall,” *Aerospace America* (April 1998): pp. 12–13; Eric J. Lerner, “A Letter from Space Telescope Science Institute,” *Aerospace America* (February 1991): pp. 8–10; Tod Lauer, oral history interview by author, 15 August 2016; Christopher Burrows, oral history interview by author, 15 February 2017; 1990 STScI News Releases archived on <https://hubblesite.org>. For more on image deconvolution, see R. L. White and R. J. Allen, eds., *The Restoration of HST Images and Spectra* (Baltimore, MD: STScI, 1990).
- 25 H. John Wood, notebooks on his work with HST 1990–1994, “Record I,” 16 July–4 October 1990, and “Record II,” 5 October 1990–22 January 1991. The 12 notebooks that Dr. Wood (1938–2014) made on his work on HST from July 1990 to post-servicing verification in 1994 were loaned to the author by his wife, cultural historian Dr. Maria J. Wood. The journals constitute a valuable eyewitness account of NASA’s work to repair Hubble. They have since been given to the GSFC archive.
- 26 Tatarewicz, “HST Servicing Mission,” p. 377; Chaisson, *The Hubble Wars*, p. 328.
- 27 Wood notebooks, “Record II.”
- 28 Kathryn D. Sullivan, *Handprints on Hubble*, pp. 34–38, 56–74; Story Musgrave, oral history interview by author, 25 October 2016, pp. 2–4. Despite the importance of spacewalking, very little has appeared in the popular or historical literature about this work. One exception is Bob McDonald, *Canadian Spacewalkers: Hadfield, MacLean and Williams Remember the Ultimate High Adventure* (Madeira Park, BC: Douglas & McIntyre, 2014).

- 29 Sullivan, *Handprints on Hubble*, pp. 101–130.
- 30 Sullivan, *Handprints on Hubble*, pp. 56–59, 76–81; Cepollina, oral history interview, 8 May 2015, pp. 2–6; Robert Zimmerman, “Mr. Fix It: Frank Cepollina Takes Repair Calls to New Heights,” *Air & Space Smithsonian* (May 2010); David S. F. Portree and Robert C. Treviño, eds., *Walking to Olympus: An EVA Chronology* (Washington, DC: NASA History Office, Monographs in Aerospace History Series #7, October 1997). Particularly notable were problems during satellite rescue missions on STS-51A in November 1984 and STS-51I in August 1985.
- 31 Sullivan, *Handprints on Hubble*, p. 167.
- 32 Sullivan, *Handprints on Hubble*, pp. 139–154, 175–198. Ron Sheffield, oral history interview by author, 30 September 2016, pp. 3–6. Sullivan, oral history interview by Jennifer Ross-Nazzal, 12 March 2008 and 28 May 2009. Quote from 2008 interview, p. 62. After STS-31, Sullivan was assigned to a non-HST Shuttle mission.
- 33 Tatarewicz, “HST Servicing Mission,” pp. 377–378; Joseph Rothenberg, “Hubble Space Telescope: Restoring the Image,” *Optics & Photonics News* (November 1993): pp. 10–16; Wood notebooks, “Record IV,” 6 June to 25 September 1991.
- 34 Thor Hogan, *Mars Wars*, pp. 120–124, discusses the NASA budget situation. Jon Meacham, *Destiny and Power: The American Odyssey of George Herbert Walker Bush* (New York, NY: Random House, 2015), pp. 409–418, 443–449, addresses the budget deal, which emerged the same week HST’s spherical aberration was announced and has since been widely blamed for Bush’s defeat in the 1992 election.
- 35 Trauger, “The Camera That Saved Hubble”; Trauger OHI, pp. 2–3, 14–16; Weiler OHI, p. 11; Jeff Hester, oral history interview by author, 20 March 2017, pp. 13–17; Arthur H. Vaughan and David H. Rodgers, “Development of the Second Generation Wide Field Planetary Camera for HST,” *Optics & Photonics News* (November 1993): pp. 17–21; *Fact Sheet: Wide Field and Planetary Camera-II*, NASA Jet Propulsion Laboratory, 2 November 1993; Kathy Sawyer, “Scientists Agree to Trim Hubble Part,” *Washington Post* (20 October 1991): A8.
- 36 Launius and DeVorkin, *Hubble’s Legacy*, (Washington, DC: Smithsonian Institution Scholarly Press), p. 60; “NASA Awards Contract to Complete ‘Costar,’ Designed to Fix Hubble Telescope Optics,” *Aviation Week & Space Technology*, (21 October 1991): 98; John Troeltzsch, e-mail to author, 18 April 2017; Tatarewicz, “HST Servicing Mission,” pp. 376–378; Todd Neff, *From Jars to the Stars: How Ball Came to Build a Comet-Hunting Machine* (Denver, CO: Earthview Media, 2010), pp. 59–64. For more on the history of Ball, see Dennis Baumgarten, ed., *Ball Aerospace: The First Forty Years* (Ball Aerospace and Technologies Corp., 1996).
- 37 James H. Crocker, “Engineering the COSTAR,” *Optics & Photonics News* (November 1993): 22–26; Crocker OHI, pp. 16–17; John Troeltzsch, oral history interview by author, 22 September 2015, pp. 5–10; Paul Lightsey, oral history interview by author, 22 September 2015, pp. 1–7; NASA Facts, *Corrective Optics Space Telescope Axial Replacement (COSTAR)*, Goddard Space Flight Center, June 1993; Ball Corporation, *Technology Update: Corrective Optics Space Telescope Axial Replacement (COSTAR)*, undated; “Corrective Optics to Star in Drama to Fix Telescope,” *Aviation Week & Space Technology* (24 May 1993): 44–45; Mark A. Stein, “Obscure Firm Took Task to Focus Hubble,” *Los Angeles*

- Times* (8 December 1993). See also Harold J. Reitsema, "The Corrective Optics Space Telescope Axial Replacement," in Launius and DeVorkin, *Hubble's Legacy*, pp. 54–60.
- 38 NASA Facts, "Corrective Optics Space Telescope Axial Replacement (COSTAR)," Goddard Space Flight Center, NF-181, June 1993; Fisk, comments at HST 25th Anniversary panel. There, he said that the money had been taken from the International Solar Terrestrial Physics Program. See also Pellerin OHI, p. 35.
 - 39 Cepollina, oral history interview, 8 May 2015.
 - 40 Rothenberg, "HST: Restoring the Image," pp. 15–16; Dennis Hancock, "'Prototyping' the Hubble Fix," *IEEE Spectrum* (October 1993): 34–39; Larry Dunham, oral history interview by author, 19 September 2017, pp. 2–4; Jackson and Tull website, "Hubble Space Telescope Project," <http://www.jnt.com/hst.php> (accessed 1 November 2017). VEST was originally set up in Building 29 at Goddard. VEST was proposed by various people before HST was launched, and was built by Jackson and Tull, a minority-owned contractor located near GSFC.
 - 41 Rothenberg OHI, pp. 26–30; NASA Headquarters News Release, "Space Shuttle Crew Assignments Announced," release 92-37, 16 March 1992; Musgrave OHI, pp. 2–8; Tatarewicz, "HST Servicing Mission," pp. 378–380; Portree and Treviño, eds., *Walking to Olympus*, pp. 88–91; Wood diaries, "Record V," notes on 20 February 1992, "Record VI," notes on 20 April 1992, project review.
 - 42 Hogan, *Mars Wars*, pp. 130–135.
 - 43 Daniel Goldin, oral history interview by author, p. 2, 8 August 2017.
 - 44 Wood diaries, "Record VI," project review, notes on 20 April 1992.
 - 45 Goldin OHI, p. 6.
 - 46 The various reviews are discussed in Ronald L. Newman, *STS-61 Mission Director's Post-Mission Report: NASA Technical Memorandum 104803* (Houston, TX: NASA Johnson Space Center Space Station Program Office, January 1995). "Report of the Task Force on the Hubble Space Telescope Servicing Mission," (Washington, DC, 21 May 1993). See also Rothenberg OHI, pp. 26–30.
 - 47 NASA Headquarters News Releases, "Crew Assignments Announced for STS-58 and STS-61," release 92-136, 27 August 1992; "NASA Announces Space Shuttle Crew Assignments," release 92-218, 8 December 1992; Tatarewicz, "HST Servicing Mission," pp. 380–383; Goldin OHI, pp. 4–5.
 - 48 Newman, *Mission Director's Report*, pp. 11, 30, 31, 55; Musgrave OHI, pp. 18–20; Tatarewicz, "HST Servicing Mission," pp. 384–385.
 - 49 Tatarewicz, "HST Servicing Mission," pp. 384–387; ESA Press Release, "No. 5-1993: Hubble Space Telescope Servicing Mission Joint ESA/BAE UK Technical Briefing Wednesday 10 March 1993," 17 February 1993. Musgrave quote from Musgrave OHI, pp. 17–18.
 - 50 *Designing an Observatory for Maintenance in Orbit* (Huntsville, AL: Space Telescope Project Office, Marshall Space Flight Center, 1986) pp. 11–13; NASA "Space Shuttle Mission STS-61 Press Kit," 1993, pp. 21–41. The FSS berthing system for HST servicing mission was far more elaborate than the four latches that held HST in the payload bay before it was deployed on STS-31 in 1990.

- 51 *NASA Fact Sheet: HST Servicing Mission: Cost to Taxpayers*, (Washington, DC: NASA Headquarters, August 1993); Faye Flam, “NASA Stakes Its Reputation on Fix for Hubble Telescope,” *Science*, vol. 259 (12 February 1993): 887–889. For more on NASA’s budget, see Andrew Lawler, “Mikulski, Stokes Warn NASA Funds Will Shrink,” *Space News*, (8–14 November 1993).
- 52 Rothenberg, “HST: Restoring the Image,” pp. 14–16; Newman, *Mission Director’s Report*, p. 48; Tatarewicz, “HST Servicing Mission,” p. 381; Portree and Treviño, eds., *Walking to Olympus*, pp. 93–98.
- 53 Piers Bizony, *Island in the Sky: Building the International Space Station* (London: Aurum Press, 1996), pp. 70–79; Michael Hanlon, *The Worlds of Galileo: The Inside Story of NASA’s Mission to Jupiter* (New York: St. Martin’s Press, 2001), pp. 57–68; Tatarewicz, “HST Servicing Mission,” pp. 381, 388, 389.
- 54 Flam, “NASA Stakes Its Reputation,” *Science*; Newman, *Mission Director’s Report*, pp. 13–14.
- 55 John Noble Wilford, “Mission to Correct Hubble’s Flawed Vision Faces Many Pitfalls,” *New York Times* (30 November 1993).
- 56 Dennis Overbye, “Hubble Jeopardy,” *The New York Times Magazine* (28 November 1993).
- 57 Frank Kuznik, “The Must-Win Mission,” *USA Weekend* (26–28 November 1993).
- 58 Kathy Sawyer, “NASA Reassured About Hubble Camera,” *Washington Post* (28 September 1993); Newman, *Mission Director’s Report*, p. 71.
- 59 James R. Asker, “Flight to Fix Hubble Pays Off,” *Aviation Week and Space Technology* (13/20 December 1993): 24–27; Goldin OHI, p. 4; Tatarewicz, “HST Servicing Mission,” p. 367. The author watched live *NASA Select* coverage of STS-61 carried on his local cable service in Canada. Since video streaming on the internet was still in the future, the only other way to access the service would have been with a satellite dish.
- 60 Asker, “Flight to Fix Hubble”; Portree and Treviño, eds., *Walking to Olympus*, pp. 100–102; Musgrave, oral history interview, pp. 24–27. In May 2019, comments on a draft of this book, STS-21 astronaut Kathryn Sullivan said the problems closing the door could have been averted if Goddard experts had paid more attention to data gained during a pre-deployment ground test and documented in Lockheed’s photo database. Sullivan said, “Light pressure needed to be applied to a specific spot on the larger door in order to close it smoothly.”
- 61 Asker, “Flight to Fix Hubble”; Portree and Treviño, eds., *Walking to Olympus*, pp. 102–103; Hawley, “HST Solar Array Concerns,” pp. 16–17. The array burned up in Earth’s atmosphere a few months later.
- 62 Asker, “Flight to Fix Hubble”; Portree and Treviño, eds., *Walking to Olympus*, pp. 103–105; Musgrave, oral history interview, pp. 27–31; NASA Television, “STS-61 Flight Day Highlights,” 6 and 8 December 1991, author’s personal collection. The wakeup music the day after the WFPC2 installation was Jimmy Cliff’s “I Can See Clearly Now.”
- 63 Kathy Sawyer, “NASA’s Orbital Success Helps Restore Credibility in the Political World,” *Washington Post* (12 December 1993): A10.
- 64 “That Mesmerizing Space Mission,” *Washington Post* (12 December 1994): C6; “Virtuosos in Space,” *The New York Times* (11 December 1992): 22.

- 65 *Home Improvement*, Season 3, Episode 24, “Reality Bites.” Review of episode available at <http://www.imdb.com/title/tt0603520/> (accessed 3 March 2017). Tatarewicz, “HST Servicing Mission” discusses the awarding of the 1993 Robert J. Collier Trophy for achievements in aeronautics and astronautics to the HST Recovery Team.
- 66 Burrows OHI, p. 26; Hester OHI, pp. 24–26; David H. DeVorkin and Robert W. Smith, *The Hubble Cosmos: 25 Years of New Vistas in Space* (Washington, DC: National Geographic Society, 2015), pp. 51–53; Trauger, “WFPC2: ‘The Camera that Saved Hubble.’”
- 67 Wood Diaries, “Record X,” notes from 20, 26, and 28 December 1993.
- 68 Goddard Space Flight Center, *NASA Facts: HST Servicing Mission Observatory Verification*, NF-194, June 1993; Hester, oral history interview, pp. 24–26.
- 69 John Noble Wilford, “Hubble Repair Called a Success, and NASA Says Pictures Show It,” *New York Times* (14 January 1994): A1. See also John Noble Wilford, “Astronomers Say Hubble Repairs Were Successful,” *New York Times* (13 January 1994): A15; Kathy Sawyer, “Given New Focus, Hubble Can Almost See Forever,” *Washington Post* (14 January 1994): A1.
- 70 Newman, *Mission Director’s Report*; Tatarewicz, “HST Servicing Mission,” pp. 394–395.
- 71 Public Broadcasting Service, *Nova*, “Invisible Universe Revealed,” first broadcast 22 April 2015; Weiler, OHI, p. 7. The author reviewed the DVD of the show *Nova*, which covers HST’s first 25 years in space and found that it referred to the WFPC2 but doesn’t relate its installation to overcoming spherical aberration. Trauger, “WFPC2: ‘The Camera that Saved Hubble.’” Astronomer Jeff Hester, one of the investigators behind the famous “Pillars of Creation” image and a member of the WFPC2 team, complained in his oral history interview with the author that he often hears the term “post-COSTAR WFPC2” in spite of the fact that COSTAR has nothing to do with WFPC2’s images. Hester OHI, p. 23.
- 72 See Cycle 5 statistics in *STScI Newsletter*, vol. 11, no. 2 (December 1994): 46–56 and Cycle 6 statistics in *STScI Newsletter*, vol. 13, no. 1 (February 1996): 10–21. These two cycles took place after SM1 and before SM2 in 1997. In an e-mail to the author on 29 July 2019, STScI’s Neill Reid said, “Both GHRS and FOS received substantial interest and allocated time; FOC had less interest, but still a reasonable complement of programs. This isn’t surprising since all three of those instruments provided coverage at UV wavelengths (and spectra, as opposed to images) not possible with WFPC2.” Duccio Macchetto, Principal Investigator for FOC, reported that the instrument lost some ability to observe faint objects and some angular coverage once COSTAR was installed (Duccio Macchetto, oral history interview with author, 9 May 2017, pp. 9–10).
- 73 Weiler OHI, p. 89.



CHAPTER FOUR

The Power of the Image

▲ Hubble's iconic image of the Eagle Nebula's "Pillars of Creation" was retaken in 2014 by Wide Field Camera 3. (NASA/ESA/Hubble/Hubble Heritage Team: heic0501a)

Although a flurry of impressive images in January 1994 established that the Hubble Space Telescope had been successfully fixed in Servicing Mission 1, HST was not yet fully redeemed in the eyes of many people. As STScI's News Director Ray Villard explained, journalists still called HST the "repaired Hubble" in 1994. That impression was fostered because there were few new images from the telescope in the first months that followed those first post-repair images. Then in May, the flow began to pick up, with impressive images showing Pluto and its moon Charon, Jupiter and its moon Io, a supernova in the Whirlpool galaxy, and mysterious rings around Supernova 1987a. Most importantly, HST found evidence of a gigantic black hole in the giant galaxy known as M87, which led to the finding that nearly all galaxies have supermassive black holes at their centers.¹

Hubble also imaged fragments of Comet Shoemaker-Levy 9 on their way to Jupiter. The fragments struck the largest planet in our solar system during the third week of July as the world marked the 25th anniversary of Apollo 11 landing the first humans on the Moon. HST and many telescopes on Earth were aimed at Jupiter that week, but scientists did not know what would happen when the cometary fragments hit Jupiter's cloud decks. If the fragments did not leave a mark and HST found no change, some feared the public might conclude that HST still did not work properly. In spite of these fears, Villard and his counterpart from NASA Headquarters, Don Savage, organized a major media event that week at STScI featuring the comet's co-discoverers, Eugene M. and Carolyn S. Shoemaker and David H. Levy. Starting with the first impact on July 16, the

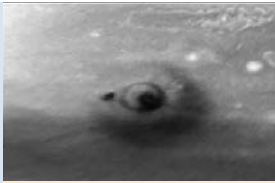

18 July 1994

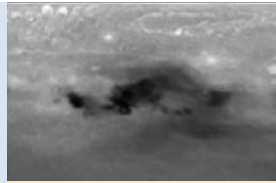

23 July 1994

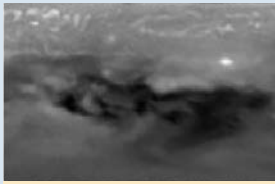

30 July 1994

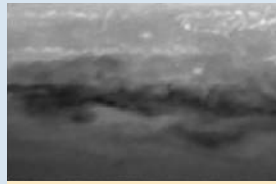

24 August 1994

▲ HST produced many images of Jupiter after nuclei of Comet Shoemaker-Levy 9 struck the planet in July 1994. These are black-and-white images taken in near-ultraviolet wavelengths with WFPC2 showing how Jovian winds reshaped the impact features on Jupiter over time. (NASA/STScI)

fragments left large marks on the planet that were visible even in the telescopes of amateur astronomers. But the first confirmation for most Americans came from an HST image shown live on CNN, the Cable News Network. Villard compared the press conferences that week to the large media gatherings at JPL between 1979 and 1989 when the two Voyager spacecraft gave the world its first close-up views of the outer planets. And he called it a turning point in the media and

public perception of HST, which henceforth was no longer called the “repaired Hubble” by the media. He stated, “After Shoemaker-Levy and all the daily pictures we put out from Hubble...nobody qualified it. They just said Hubble.”²

Two more images released in the next 18 months sealed HST’s public reputation as Earth’s window on the universe. The first resulted from observations for a research team led by Arizona State University astronomers Jeff Hester and Paul Scowen that was examining the effects of radiation from very large stars on the gas and dust of nebulae in surrounding areas. Hester, a member of the WFPC2 team, and Scowen chose to image the Eagle Nebula, an object in the constellation Serpens that had made its way into 18th century French astronomer Charles Messier’s Catalogue of Nebulae and Star Clusters, and has since been a favorite target of both professional and amateur astronomers. On 1 April 1995, WFPC2 obtained eight images through four filters in different wavelengths of a central region of the nebula known to contain what were variously described as “fingers” or “elephant trunks.” When the images first arrived, Scowen and then Hester were strongly impressed with the detail of the structures, which had never before been seen with such clarity. Moreover, they had aimed HST in such a way to have the structures that quickly became known as pillars to line up to fit inside the chevron shape of the WFPC2 images. Soon Hester was at an event at Goddard, where he showed the image to HST Chief

Scientist Ed Weiler, whose jaw dropped. Once Hester, Scowen, and their group had prepared a paper on their scientific findings, Weiler arranged for a televised NASA press conference on 2 November where the dramatic processed image was made public. A photo caption described the image as the “Pillars of Creation,” referring to the fact that it showed stars being formed. As Weiler anticipated when he first saw it, the image got strong press coverage.³

The “Pillars of Creation” remains the most famous image associated with HST, appearing on all manner of goods, including CD and book covers, postage stamps, and t-shirts. “The image was just one that people reacted to,” Hester

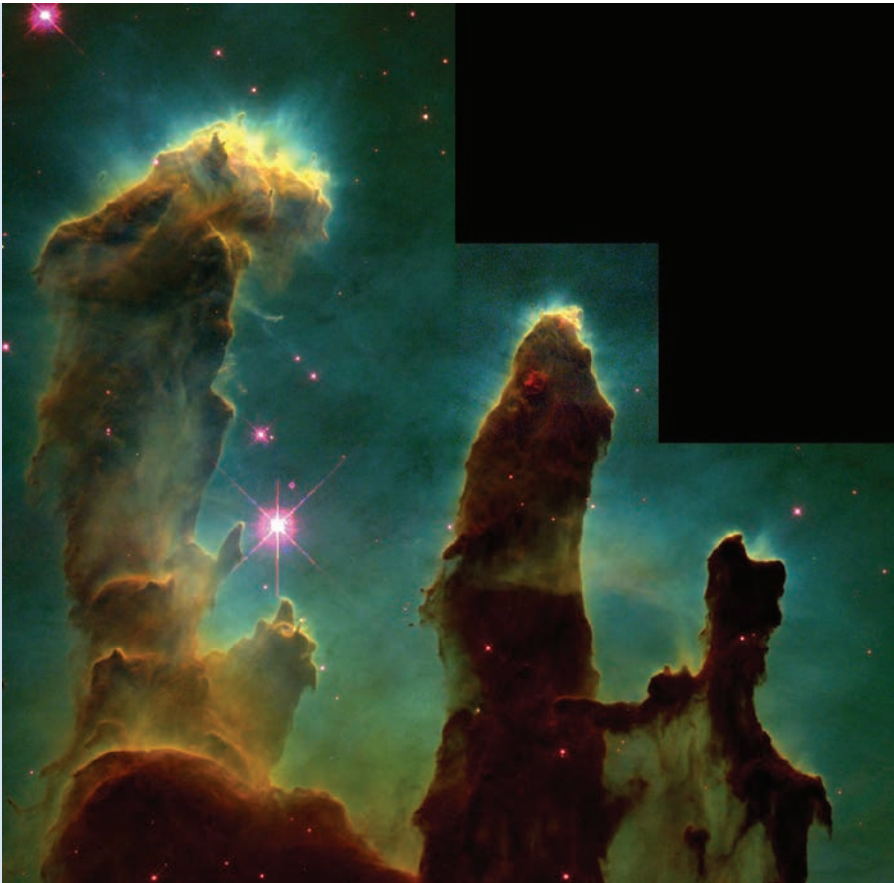

▲ The original 1995 Eagle Nebula “Pillars of Creation” image was created from three separate images taken through different filters on 1 April 1995 by WFPC2. This image shows WFPC2’s signature “stairstep” or “batwing” shape due to the smaller size of one of the four detectors in the camera. This photo shows a region in the nebula where new stars are formed. The nebula, also known as M16, is in the constellation Serpens and is about 6,500 light-years away from Earth. (NASA/STScI)

recalled, noting that many people have approached him simply to talk about their impressions of the image.⁴ When he retired from astrophysics, Hester took his experiences with the “Pillars of Creation” and his work on WFPC2 in the wake of HST’s spherical aberration problem to a new occupation as a career coach, facilitator, and speaker. In 2016, *Time* magazine named it one of the 100 Most Important Images of All Time. The ESA Herschel Space Observatory imaged the same area in the infrared in 2011, and NASA and STScI kicked off HST’s 25th anniversary year with the release of two wider-angle and sharper versions of the pillars taken with HST’s Wide Field Camera 3, one in visible light and the other in near-infrared light.⁵

Only two months after the public release of “Pillars of Creation,” NASA and STScI released the image known as the “Hubble Deep Field” at a meeting of the American Astronomical Society in San Antonio. The story of this image of distant galaxies, which represented humankind’s deepest view into space up to that time, is discussed in detail in chapter six. Like the “Pillars” image, the “Deep Field” further superseded Hubble’s early problems in the public memory. Hubble’s images of the Jupiter comet crash, the Eagle Nebula, and the Deep Field are also notable because they were among the first images accessed by large numbers of people using personal computers and the internet. The arrival of these new technologies radically altered the way both the public and scientists interacted with HST, and HST also played a notable part in popularizing these technologies in the 1990s. This study now turns to Hubble’s role as one of the first bright stars in cyberspace, focusing on its role as a public observatory.

DIGITAL IMAGING

HST stood at the nexus of traditional media and new ways of disseminating information that were just emerging at the time of its launch. HST’s design and prominence helped drive changes in how information was diffused to the public and also how astronomy was done as digital imaging and the internet became part of everyday life. As the first space telescope designed to produce high-definition images, HST’s catalytic role in astronomical imaging began with the basic question of how to move images taken by the telescope from space to Earth.

When astronomers began serious discussions in the 1960s about a large space telescope, glass photographic plates remained the primary means of astronomical imaging for ground-based telescopes. But the digitization of astronomy was under way in the 1960s as astronomers long accustomed to gathering data by analog methods, including written notes, strip charts, and photographic plates and film, started to turn to digital recording in the 1950s and 1960s as

computers began to appear in observatories, along with other electronic means of recording data. The growth of radio astronomy contributed to this trend since data from radio telescopes were collected in electronic form.⁶ Color images in astronomy dated back to 1959, when William Miller, the staff photographer at the Mount Wilson and Palomar Observatories, produced color photos using new photographic films that could be exposed for the long periods of time required when imaging distant objects in space. Miller found it necessary to use filters to correct the new films' varying sensitivities to different colors.⁷

The decisions about HST imaging did not take place in isolation from changes affecting how astronomy was done on Earth or imaging in space. Photographic film had many drawbacks, including the need to bring it back to Earth for development and the fact that its sensitivity to light was less than five percent. U.S. military reconnaissance satellites used photographic film for high definition black-and-white photographs and dispatched that film to Earth inside "buckets" that entered Earth's atmosphere and parachuted to a designated pickup point, after which the film was processed. Even the most advanced of these film-based satellites, the Hexagon KH-9, had a limited lifetime because it carried only four reentry "buckets" on board.⁸ When astronomers were considering early concepts for the Large Space Telescope in 1965 at a meeting at Woods Hole, Massachusetts, they discussed using either photographic film or a type of electronic detector to catch photons from distant objects. By 1971, scientists working on the Space Telescope were pressing for some type of electronic retrieval of images. At that time, the most promising technology appeared to be a type of television tube called the SEC Vidicon, which had won financial research support from NASA. Similar vidicon detectors had been proposed as early as the late 1950s and flew on several robotic spacecraft, including early weather satellites, robotic spacecraft that traveled to the Moon and Mars, and the Orbiting Astronomical Observatory 2 in 1968. Vidicons, however, were not the only type of electronic detector available. A new type of detector called a Charge-Coupled Device (CCD) had been invented at Bell Laboratories in 1969. These lightweight devices were solid state silicon chips that produced a charge replica of the light pattern falling on them, and they quickly drew commercial interest. During the 1970s, electronic manufacturers actively developed CCDs for use in television and still cameras. In the late 1970s, U.S. intelligence agencies began to transition to reconnaissance satellites that transmitted high definition digital images to ground stations. CCDs drew the interest of NASA for space telescopes and other spacecraft, but early CCDs had drawbacks of their own, among them their small image sizes and low sensitivity to ultraviolet light.⁹ Astronomers who were developing high-resolution cameras for the space

Bubble Nebula

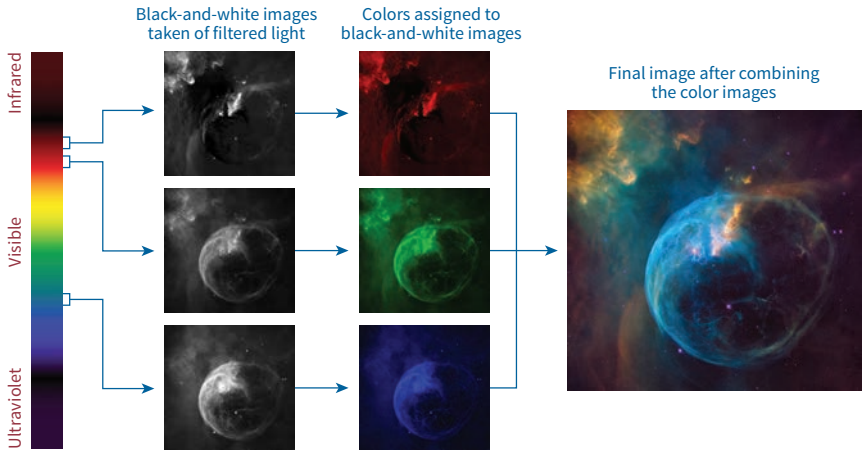

Crab Nebula

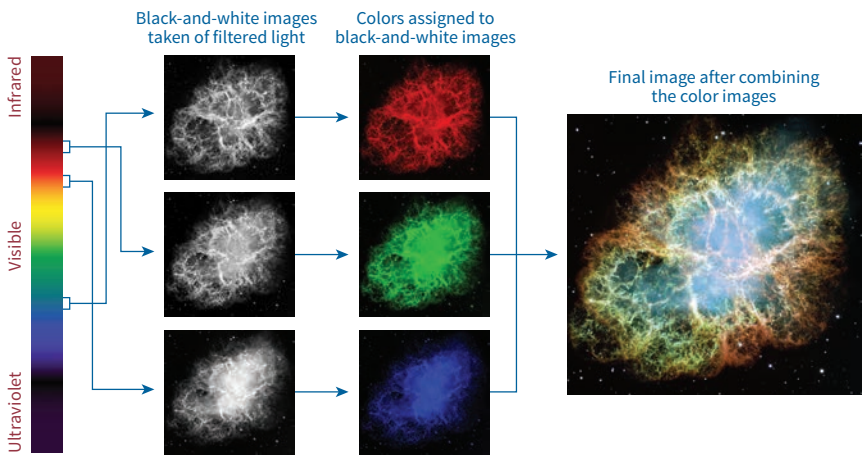

▲ Examples of multiple grayscale images shot through filters of different wavelengths for assembly into color images. One shows the Bubble Nebula, NGC 7635 in the constellation Cassiopeia, and the second the Crab Nebula, M1 in Taurus. (STScI)

telescope in the early 1970s began to give more serious consideration to CCDs. By 1976, the quality of new CCD detectors began to improve, while the capabilities of SEC Vidicon detectors remained limited. That year a CCD camera attached to a ground-based telescope produced a revealing image of Uranus, an event that caused planetary astronomers to support CCDs. A meeting of the Science Working Group for the Space Telescope in October 1976 decided that

the issue of the kind of detectors to be used in the Space Telescope should be left open when NASA asked astronomers for proposals for instruments, given the shifting perceptions of the two types of detectors.¹⁰

The design for the Space Telescope was coming together in 1977 with places for five instruments, two of which would be cameras. NASA had decided that there would be a place for a wide field camera, and as part of its contribution to the telescope the European Space Agency proposed a Faint Object Camera, which would use a photon counter combined with a television tube to produce images. When NASA issued its Announcement of Opportunity for the instruments in March 1977, the three proposals NASA received for the wide field camera all involved CCDs, reflecting the growing shift amongst astronomers in favor of CCDs. A proposal from Princeton, where NASA had supported research into SEC Vidicon detectors, incorporated both a vidicon and a CCD to image in the far red section of the spectrum, where the vidicon was weak. Competing proposals from Goddard, and the Jet Propulsion Laboratory and Caltech, were based on CCD detectors. Since a major goal of the Space Telescope was to obtain images in the ultraviolet, James A. Westphal, a Caltech astronomer who was Principal Investigator for the JPL/Caltech proposal, cast about for a solution to the CCD problem with ultraviolet light. As recounted by Robert Smith, Westphal found an idea in a book about ultraviolet spectroscopy. By coating the detector with a substance that fluoresces when struck by ultraviolet light, the problem could be solved. Westphal chose a substance called coronene, and when he tested a CCD coated with it in the 200-inch Hale Telescope on Mount Palomar, the idea worked. Westphal's group designed their camera to operate in two modes—one for wide field images and the other with higher resolution for planetary images. Their design also overcame another problem with CCDs—their limited size—by “mosaicking” together four CCD chips to replicate the size of a larger CCD chip. Westphal's team won the competition to build the wide field camera for the space telescope in 1977. When the NASA management of the Space Telescope chose the JPL/Caltech proposal for what became known as the Wide Field/Planetary Camera, the technology for the CCD detectors was still being created—NASA managers and officials were in fact counting on invention.¹¹

By the time HST was launched in 1990, CCD imagers had proven themselves to be far more sensitive and easier to use than photographic film, and so CCDs replaced photographic plates and film in most professional astronomical observatories. Starting in the late 1990s, the almost exponential growth in computing power in personal computers, the arrival of the internet for private users, and falling prices and increasing quality of CCDs caused amateur astronomers

to begin swapping photographic film for CCDs. This trend accelerated in the new century. Digital imaging also opened the door to more manipulation of images, and during this time there was a great deal of comment about the idea that images could no longer be trusted as photographs had been in the past. One high profile controversy centered on a 1982 cover image in *National Geographic* magazine where the pyramids had been moved. Adobe Photoshop, the program that has been most strongly associated with digital manipulation of images, was introduced in 1990, the year HST was launched, and version 3 of the program released in 1994 contained advances such as layering that made it particularly useful for astronomical photography.¹²

RELEASING HST IMAGES

Images have long been a powerful and direct way of imparting information to a wide audience, and Stanford University art historian Elizabeth A. Kessler has argued that astronomy has a special relationship with imaging. In *Picturing the Cosmos* Kessler wrote, “Astronomy often serves as the poster child for science by displaying the wonder and discovery in a nearly visceral manner and without the ethical conflicts that accompany scientific advances in other fields, such as genetics. In many ways, astronomy is about the pleasure of looking.”¹³ When NASA launched HST, public expectations were high for spectacular images from the cameras onboard the space telescope. Previous telescopes that had flown in space had produced spectrograms, non-imaging forms of data, or images in nonvisual wavelengths such as x rays. They therefore won little attention from the public. NASA and many astronomers had strongly promoted HST’s promise of colorful views of the universe, but until NASA reluctantly agreed just before launch to release HST’s “First Light” image, there had been no plan to release images during HST’s commissioning period.

Most of the astronomers with authority over HST were unprepared for the public relations challenges that they would face when HST was launched, although STScI director Riccardo Giacconi was a prominent exception. When the Space Telescope Science Working Group, which included the Principal Investigators for HST instruments and other scientists with leading roles in the program, met in April 1986 at Goddard, a NASA public affairs official introduced the matter of communicating HST’s findings in a presentation that focused on procedures for press releases. During the discussion that followed, Giacconi said HST should obtain some images that could be given out to the public. If that isn’t done, he said, “we are crazy.”¹⁴ Giacconi, was keen to release images because of his own history with the Einstein X-ray Observatory. Shortly after Einstein was launched eight years earlier, Giacconi obtained four x-ray

images of “bright and splendid” objects and shared them with media, who “were so grateful that they judged the mission favorably even when it terminated prematurely.” The early image releases also gave the scientists breathing room to calibrate the satellite without media questioning.¹⁵ Although nothing was decided at the Science Working Group meeting, many of those present had different concerns that did not come up until later.

Two years later, the Science Working Group charged Eric J. Chaisson, STScI’s newly hired senior scientist and director of educational programs, to draw up a list of objects for the telescope to image for public release early in its flight. Chaisson later wrote that he thought these images would provide data for scientists to work with in case HST failed early in its flight and help create support for HST amongst a public primed to expect dramatic results. While Chaisson won support from Giacconi and other HST scientists, Westphal and John Bahcall, the leading astrophysicist whose lobbying work over the two previous decades was crucial in making Hubble possible, opposed his plan. Bahcall vociferously objected out of concern that early public release of long-awaited images could negatively affect the work of scientists who had worked for years to make HST a reality but had not yet obtained astronomical data. The Institute, NASA, and scientists had agreed on rules where observers who used HST would have sole proprietary control of that data for a year, after which the data would be made available to other researchers and the public.¹⁶ A year before the launch, an article in the leading scientific periodical *Nature* reported that any images from HST released before scientific work started “must specifically not have any scientific interest,” leaving STScI with the dilemma of “producing first images which are both spectacular and uninteresting.”¹⁷

The concerns of Westphal and other astronomers about public release of images were crystallized by a controversy that followed the publication of dramatic and unprecedented images and other data from Jupiter and its moons obtained by the Voyager 1 spacecraft in 1979. One of Voyager 1’s biggest findings was that the moon Io had active volcanoes. All Voyager images were released in real time, although in those pre-internet days, anyone not at the JPL control center would have had difficulty accessing them. Bradford A. Smith, who led Voyager’s imaging team, told Westphal in a letter later that year that imaging team members were approached by more than a few outside colleagues who wanted to submit interpretive papers based on news-media releases. Most backed down after discussion, but Smith said one post-doctoral student wrote to a prominent journal with his interpretation of the incomplete data that had appeared in the media. Smith, who would later serve on the WF/PC science team with Westphal, warned that HST observers could be “competitive with

any professionals of questionable integrity who happen to see your data in the *Washington Post*,” and his warning was reflected a decade later in Westphal and Bahcall’s reactions to Chaisson’s plan for early releases of HST images.¹⁸ At one heated meeting at STScI in 1989, Bahcall warned Chaisson, “If you look at those objects before I do, I’ll kill you.”¹⁹ Chaisson continued to try to find a list of objects, but at a meeting of the Scientific Working Group in January 1990, three months before the launch, the group blocked this final effort to obtain images for public release quickly after launch. The dispute over Chaisson’s image release plan became a central episode in the controversial 1994 book, *The Hubble Wars*, that Chaisson wrote after leaving the Institute in 1992.²⁰

The media was finally invited to view the arrival of a “First Light” image from HST nearly a month after launch, as was discussed in chapter two. That WF/PC image on 20 May was released along with comparison images taken from the Las Campanas Observatory, followed a month later by the “First Light” image from the European Space Agency’s Faint Object Camera. On 27 June, NASA officials announced HST’s spherical aberration problem, and the matter of releasing images from the space telescope was off the table for the moment. By then, a public release policy for HST had been established to take effect on 1 July that called for image release requests to originate with scientists before being routed through STScI’s Education and Public Affairs Office and NASA Public Affairs prior to release, roughly the policy that has existed through the life of HST since that time.²¹

While most effort at Goddard and the Institute turned to understanding the extent and causes of Hubble’s defective main mirror, the Science Working Group met again in August, and Bahcall again forcefully stated his objections to early image releases. This time, no one else supported him, since many people were more worried about the future of HST, and Bahcall stormed out of the meeting. Villard commented that spherical aberration meant that opposition to the idea of an early release program for images once HST was repaired “all went away.”²² The commissioning work on HST continued, and the flow of images from WF/PC and FOC began in August as the two instruments began to obtain quality images of star clusters, nebulae, galaxies, and solar system objects such as Saturn. While the images taken during that time were important for the scientific investigations, only a few had the visual appeal that had been hoped for before HST was launched. As was discussed in chapter three, astronomers used image deconvolution techniques to alleviate the effects of spherical aberration in some of these images. “The continuous coverage showed that Hubble was at least operating, and people liked the pictures,” Villard said of the time between the discovery of spherical aberration and the servicing

mission that repaired it. Moreover, scientists became accustomed to using HST and operating with policies such as those covering media releases.²³ As the servicing mission approached in 1993, STScI prepared a plan under NASA direction and with the agreement of astronomers for an Early Release Observation Program for “targets with straightforward scientific interest and strong visual impact” and the creation of images suitable for reproduction in print media.²⁴ No scientist ever attempted to publish a paper based on HST images taken from newspapers or magazines. According to Villard, opposition to the early releases seemed to have “evaporated” immediately after spherical aberration was found, and did not reappear.²⁵

THE INTERNET

The first images released in January 1994 from WFPC2 and the Faint Object Camera corrected by COSTAR began what later became a flood of spectacular images from Hubble. Those images, like those from WFPC2 of Comet Shoemaker-Levy 9 at Jupiter, the “Pillars of Creation” and the “Hubble Deep Field,” were widely reproduced in books, magazines, and newspapers. They were also being accessed by growing numbers of people around the world in the digital format in which they were created. This became possible in the mid-1990s because of a set of major technical advances that started in the late 1970s and the 1980s, when new devices called personal computers began to appear in large numbers in offices and homes. The very first personal computers had limited memory and processor power, and thus could not handle graphics, so for a time, more powerful computer systems such as Sun workstations were required to process or even view images. The popularity of personal computers and more powerful microprocessors helped drive advances in computing technology in the middle and late 1980s and early 1990s that made graphical user interfaces possible in devices such as the Apple Macintosh, which was introduced in 1984, and starting in 1992, equipment running the Microsoft Windows 3.1 operating system and its successors.²⁶

Personal computers became more useful thanks to the ability to network with other computers, sharing files and running a general-purpose application that became known as e-mail. This was made possible due to technical advances developed by the Advanced Research Projects Agency (ARPA) of the U.S. Department of Defense, which began the ARPANET computer network in 1969 using specially developed data transfer protocols. After classified and other military uses were spun off from ARPANET in the early 1980s, it was closed down in 1990, and the National Science Foundation took over support of the expanding internet. Amidst the spread of personal computers with

greater capabilities and increasing bandwidth between networked computers in the early 1990s, the first web browsers with their easy-to-use interfaces to the World Wide Web made the internet easily accessible to millions of users. By 1995, commercial users with their “dot.com” suffix dominated the internet.²⁷

Along with other government and educational institutions, NASA and STScI had long been part of the internet offering e-mail and file transfers, but the new capabilities of the 1990s meant that they had to prepare for widespread public access. NASA was quick to establish a presence on the World Wide Web with the first NASA website. “As I recall, the first effort at a NASA-wide home page was published in 1992 or ‘93 out of Goddard in an effort to collect links to all those early NASA sites,” said NASA Headquarters Web Manager Brian Dunbar. The first formal NASA home page, containing original content and managed by the Office of Public Affairs at NASA Headquarters, went online in July 1994 at the time of the 25th anniversary of Apollo 11.²⁸ STScI sought that year to promote use of the internet by “developing the public education potential” of HST and sharing Hubble data with the public.²⁹

That July was also the time of Comet Shoemaker-Levy 9, and some astronomers and well-equipped enthusiasts followed its impacts over the internet using electronic bulletin boards, a popular internet communications tool of the time, and early websites.³⁰ A 1999 Institute report on HST’s public impact found that the January 1996 release of the “Hubble Deep Field” was particularly popular, with 4.46 million hits on the Institute website at a time of still limited internet use. Among space missions of the time, only the Mars Pathfinder spacecraft, which landed on Mars nearly 18 months later in 1997, outperformed HST, and then for only a brief period. Mars’ enduring popularity with the public was demonstrated when a Hubble image of the Red Planet taken during its close passage to Earth in 2003 brought down STScI’s servers.³¹

The Institute created a new public web portal, HubbleSite, for HST’s 10th anniversary in April 2000, and that year, it received 119 million hits in two million user sessions. Other sites delivered educational programs, including Amazing Space, which includes a website and other tools for educators. Hubble images and releases have also been available from NASA websites, including educational resources, that are more widely used than Institute websites, but figures for Hubble-related resources are not available. The European Space Agency, as a sponsoring agency for Hubble, has also actively promoted images and features on HST through its spacetelescope.org website.³²

Nearly a decade later, the creation of social media and the arrival of smartphones with online capabilities again changed the online world. In common with other NASA projects, HST became available on Facebook and on other

social media, including Twitter, Instagram, Google+, Pinterest, photo sharing on Flickr, and video sharing on YouTube. HubbleSite soon offered an application to bring Hubble imagery to users of iPhones and other smartphones. The NASA Hubble Twitter account is the most popular account for an individual NASA program, with more than 6.5 million followers. NASA continues to exploit new opportunities to publicize HST with Facebook live events and coordinated campaigns.³³

MORE HUBBLE IMAGES

When HST operations began in 1990, digital data for HST images went to STScI's Astronomy Visualization Laboratory for digital processing. The lab, a "carryover from observatories" in the words of STScI Imaging Lead Zoltan Levay, was set up in 1985 and staffed by up to three people under the supervision of John Bedke, a former chief photographer from Carnegie Observatories. Once the image data were digitally processed, a photograph was taken of the image as displayed on the screen of a Sun workstation or a similar computer system of the time, and then reproduced in print, slide, transparency, and negative forms in the Institute's darkroom and photo lab. Captions were printed on the back of prints using photocopying machines, and these images were given out at media conferences or mailed to the media. As time went on in the 1990s, images were



▲ Longtime Imaging Group Lead Zolt Levay in the Office of Public Outreach at STScI.
(Christopher Gainor)

digitally processed with various programs including Adobe Photoshop, and the digital images were put online. Finally, the photo lab closed in 2005, marking completion of the transition to digital imaging and animations.³⁴

The impact of HST images, especially the “Pillars of Creation,” impressed many astronomers. “I came to realize, talking to people about this, just how intricately linked science and art really are,” Hester commented.³⁵ Keith Noll, a planetary astronomer at STScI, was impressed by the reaction of his relatives to the “Pillars” image, and remembered how earlier images from Apollo and Voyager had inspired him when he was young. He talked with his Institute colleague Howard Bond about how HST’s cameras were used for scientific purposes, leaving few opportunities to obtain aesthetically pleasing images such as the “Pillars.” They then brought into the conversation two other STScI astronomers who also worked on public outreach, Anne Kinney and Carol Christian. Together they proposed the Hubble Heritage Project in 1997 to the outgoing director of STScI, Bob Williams. Their proposal listed many spectacular and well-known objects including the Ring Nebula, the Sombrero Nebula, and the Trifid Nebula, for which there was limited or no HST imagery. The proposal, which contemplated scientifically useful images that were also aesthetically pleasing, won financial support and some precious time on HST from Williams. With the addition of Jayanne English, Lisa Fratrarre, and Zolt Levay to the group, Hubble Heritage released its first images in October 1998—showing Saturn, the Bubble Nebula, the Sagittarius Star Field, and a Seyfert galaxy. Hubble Heritage then released one image each month while it continued. The members of the Hubble Heritage Project searched in their free time for imagery from the HST data archive, obtained funding through NASA grants, and used small amounts of HST observing time to create images or add to images already in the archive. About half the data came from the archive, and the project used about 25 HST orbits a year—less than one percent of the available observing time. Levay said, “The basic idea was to augment existing observations that may have been incomplete in some sense, so if there’s a really nice target that they only got two filters, say, and a third filter would make a really nice, visually nice image. Or they needed another orientation or pointing or something of the telescope to fill out, and it would make it look much nicer.”³⁶

Although members of the group did not originally propose to explain how they created their images from raw HST data, their first set of images came with explanations of how they were made. The Hubble Heritage team and the STScI news office explained how HST images are made on the Hubble Heritage website, in presentations to astronomers, and in articles in astronomical publications such as *Sky & Telescope*. Levay even made an appearance in 2002 on the

famous newsmagazine television show *60 Minutes*. At the time, digital image processing was relatively new to professional astronomers and was still very new and controversial to the general public.³⁷ The popularity of images from HST has inspired astronomers working at other observatories to follow Hubble Heritage's example, including other NASA space observatories. In 1999, the Cerro Tololo Inter-American Observatory and the Kitt Peak National Observatory began producing images for the public, the Canada-France-Hawaii Telescope started a "Hawaiian Starlight" image program in 2002, and the Gemini Observatory followed suit two years later.³⁸ After some of its leading members left STScI and grants from the director's office had ended, Hubble Heritage stopped producing new images in 2012. Since that time, STScI's public outreach office and the ESA have continued to produce colorful images as part of their HST public outreach work.³⁹

Hubble images have become the subject of analysis and even some debate among scientists, other academics, and media commentators, primarily over the question of how representative HST images are of reality. To some extent, this discussion is moot since by definition, astronomical telescope images do not accurately depict what the human eye would see if it were in close proximity to most astronomical objects, especially nebulae and galaxies. The human eye takes images about thirty times a second, and it is very small. Large astronomical telescopes including HST have large mirrors that can gather thousands of times more light in a given period of time than the human eye is capable of doing. These telescopes can, and except for very bright or close objects, usually do take long exposures of minutes, hours, or more to gather as much light as possible. Coming closer to a given object such as a nebula does not make it brighter in the way a telescope can make it brighter with its light gathering power and long exposure times.⁴⁰

The human eye has other limitations that also have to be taken into consideration. It can only perceive a limited range of light. Moreover, what eyes see varies amongst individuals. The retina contains varieties of cone cells that are sensitive to different wavelengths of light—these varieties are generally classified as blue, green, and red cones. The retina also contains rod cells that are highly sensitive to light but not to color. Hence, when people look through a telescope at distant objects such as galaxies or nebulae, the light is usually so dim that color is very difficult to perceive. Some bodies such as stars emit light, and others, such as planets and some nebulae, reflect light from elsewhere. In the words of Villard and Levay of STScI, "The question of true color becomes largely moot since we can't perceive it in the first place."⁴¹ As well, different photographic films and CCDs, not to mention other detectors, have

their own sensitivities to different colors. What they have in common with the human eye is the fact that they usually record red, green, and blue separately. In the case of HST, its cameras shoot only black-and-white images, but many images are exposed through different color filters, and so every HST color image is assembled from two or three monochrome images exposed through different filters. Each astronomical object emits or reflects light at different wavelengths, and therefore the people who create color images from HST data must keep that in mind when choosing filters and composing photos. The filters are chosen for their scientific utility, and usually correspond to the light emitted or reflected by particular chemical elements, such as hydrogen, oxygen, and nitrogen.⁴²

Each HST image that is released to the public is processed through special software, often including the well-known image-processing program Adobe Photoshop, to compress the range of light and compose colors. Each exposure used in an image must be calibrated to deal with sensitivity variations between individual pixels and to eliminate the effects of cosmic rays that strike the CCD detectors. Because HST operates outside the atmosphere, and its instruments can pick up wavelengths of light beyond normal human vision, HST image processors must choose what they call representative colors rather than real colors to better illustrate the scientific information being collected by images in different wavelengths. This was the case for the “Pillars of Creation” image in the Eagle Nebula because the two filters used for the original exposures were in similar wavelengths in the red part of the spectrum. A hydrogen filter was shown as green rather than red. This approach must be used in images taken with HST instruments such as NICMOS or some channels in Wide Field Camera 3 (WFC3), which imaged in the infrared or ultraviolet outside the range of optically visible light.⁴³ “While the choices of color may be somewhat arbitrary, the results are a real image and represent real physical processes that are occurring in these objects,” Levay explained.⁴⁴

HST images can be positioned in any orientation because there is no up or down for a telescope in space, but the dimensions and imaging areas of HST instruments place limitations on HST images. For example, the Wide Field/Planetary Camera 2, which was the workhorse camera of HST from its installation in late 1993 to its removal in 2009, was made up of four CCDs arranged in the staircase shape that most famously showed up in the original “Pillars of Creation” image. The processing of images from WFPC2 involved removing the seams that are located where the four CCDs overlap. In 2002, the Advanced Camera for Surveys (ACS) was installed on HST. Its two large CCDs have three times the sensitivity and higher resolution than WFPC2. Since the last

servicing mission in 2009, WFC3 has taken the place of WFPC2, and this instrument contained many imaging advances over HST's previous capabilities in both ultraviolet and infrared wavelengths.⁴⁵

HST's cameras, most famously WFPC2 and FOC, were built to take high-resolution images at high magnification, which means that they have very narrow fields of view. In the case of the "Pillars of Creation" image, WFPC2's narrow field of view dictated that it showed just the pillars rather than the wider nebula that was more familiar to astronomers. As astronomers Travis A. Rector, Kimberley Kowal Arcand, and Megan Watzke explained in their book on astronomical imaging, tight cropping can create the perception that an object is gigantic, especially when it is unfamiliar, as many astronomical objects are. Cropping can also create the sense that an object is nearby. WFPC2's limited field of view contributed mightily to the drama and allure of the "Pillars of Creation."⁴⁶

The work of the Hubble Heritage team and the outreach staff also drew criticism. Astronomers whose work is based on non-imaged data have sometimes complained that HST's images are little more than "pretty pictures." In 2003, the *Los Angeles Times* published an article by reporter Allison M. Heinrichs calling the HST images "exaggerated" and "a merger of science, art—and marketing."⁴⁷ Villard responded that he found the article unfair because he and Levay tried to fully explain their approach to processing images to the reporter as part of their effort to raise issues around image processing to the wider astronomical community.⁴⁸

Hubble images have also gained positive academic attention from outside the fields of astronomy and physics. Elizabeth A. Kessler, who has written a 2012 book and several other works exploring the background and implications of HST's images, has argued that Hubble images have characteristics that allow them to be considered as both science and art. She compared the "Pillars of Creation" image to an 1882 painting that hangs in the Smithsonian American



▲ STScI Public Information Manager Ray Villard. (Christopher Gainor)

Art Museum, Thomas Moran's "Cliffs of the Upper Colorado River, Wyoming Territory," which came out of a scientific expedition to the area, and images produced by other landscape painters and famed American photographer Ansel Adams. "It seems that the Hubble images invite us not only to look outward but to reflect on the concepts we use to describe and categorize what we see," she wrote.⁴⁹ The paintings and photographs of the rugged territory of the American West helped lead in the middle of the 20th century to Chesley Bonestell's paintings that went along with articles and books promoting space travel by Willy Ley and Wernher von Braun.⁵⁰ Kessler noted that these images also brought up the concept of the frontier, a "consistent presence in the rhetoric that circulates around space exploration."⁵¹

Kessler has argued that the experience of imagery with HST has heavily influenced representational conventions and an aesthetic style of astrophotography that favors "saturated color, high contrast, and rich detail as well as majestic compositions and dramatic lighting." She said Hubble images in this style "now define how we visualize the cosmos."⁵²

Since its launch, Hubble has been joined in space by other space telescopes, including NASA Great Observatories such as the Chandra X-Ray Observatory launched in 1999 and the Spitzer Space Telescope, which imaged in the infrared between its launch in 2003 and retirement in 2020. HST imagery has been combined with images taken by these two other spacecraft for scientific reasons, such as in the Frontier Fields programs, where astronomers image massive clusters of galaxies with the three observatories and use gravitational lensing to find what lies beyond those clusters, as well as to study the dark matter within them.⁵³ HST data are also being combined in images with telescopes based on Earth as the capabilities of those telescopes have improved. This work is assisted by the fact that these instruments also use digital equipment and common file formats such as FITS (Flexible Image Transport System). NASA released a good example of this kind of image in February 2017, a multi-wavelength image of Supernova 1987A using data from HST in visible light, submillimeter wavelengths from the Atacama Large Millimeter/submillimeter Array in Chile, and x-ray light imaged by Chandra.⁵⁴ Images such as these bear little relationship to what can be seen by the human eye, but they help illustrate important scientific phenomena such as the structure of this supernova 30 years after its explosion.

THE UNIVERSE COMES TO EARTH

The quality of data from astronomical observatories on the ground had already begun to improve in the late 1970s and the 1980s when governments and universities built more observatories in high altitude locations offering clear seeing

like the Chilean Andes and atop Mauna Kea in Hawaii. After astronomical observatories on Earth began publicizing the beautiful images they were producing with new digital technologies, amateur astronomers were equipping themselves with affordable commercial digital cameras and processing software, and started producing their own high quality images of celestial objects.

Breakthroughs in optical and computing technologies made much larger ground-based optical telescopes possible. These advances include active optics that change the shape of main mirrors in gigantic new reflecting telescopes to halt deformations caused by mechanical stress, temperature and wind, and adaptive optics that compensate for the atmospheric turbulence that causes stars to twinkle and affects the quality of astronomical images. Adaptive optics marries deformable mirrors in telescopes, massive amounts of computing power, and the use of lasers to generate artificial reference stars. Detectors following a natural guide star or an artificial guide star generated by a laser provide data on changes in atmospheric conditions that are processed in computers to make rapid changes to deformable mirrors. Despite these advances, observatories on Earth equipped with active optics and adaptive optics are still far from seriously competing with HST, since Hubble can still obtain images at a far greater variety of wavelengths than even the best ground-based telescopes. Adaptive optics typically clearly resolve only bright starlike objects in small fields of view. While telescopes on the ground are superior for specialized kinds of research, they will still require major technological breakthroughs to approach the optical image performance of HST.⁵⁵

As discussed above, HST imagery become part of the landscape of life by the beginning of the 21st century. HST images have even shown up in art museums, notably a 2008 show at the Walters Art Museum in Baltimore, “Mapping the Cosmos: Images from the Hubble Space Telescope.” Six years after Hubble was ridiculed in the movie, *Naked Gun 2-1/2: The Smell of Fear*, HST imagery of the Eagle Nebula appeared in the science fiction drama *Contact*, based on Carl Sagan’s novel of the same name. By HST’s 20th anniversary in 2010, a film in the large-screen IMAX format, *Hubble*, featured breathtaking animated sequences from HST images that take viewers on journeys through stellar nurseries in the Orion Nebula and near the Eagle Nebula, the Butterfly Nebula, and the Andromeda Galaxy.⁵⁶

The “Pillars of Creation” and the products of the Hubble Heritage Project weren’t the only HST images that engaged the public. The “Hubble Deep Field” and the stream of HST images that astronomers used to unlock the mysteries of the universe also introduced many people to the wonders of the universe. The vast improvement offered by many HST images over previously available

astronomical photos not only reflected Hubble's unique capabilities as a large telescope located above Earth's atmosphere, but also the fact that its images were produced with CCDs rather than photographic film, and delivered in digital formats over the internet. HST was far from the first telescope to use these technologies, but it was the first to distribute its imagery to such a wide audience.

ENDNOTES

- 1 Ray Villard, oral history interview, 30 October 2015, p. 18; review of 1994 news releases on <https://hubblesite.org>, accessed 25 March 2017.
- 2 Villard OHI, pp. 15–18; film of the first image of the comet impact arriving at the STScI event can be seen on a short NASA film on YouTube, “NASA’s Hubble Memorable Moments: Comet Impact,” <https://www.youtube.com/watch?v=xEids4CQ0vE> (accessed 25 March 2017).
- 3 Hester OHI, pp. 27–29; STScI, “Embryonic Stars Emerge from Interstellar ‘Eggs,’” 2 November 1995, news release STScI-1995-44; J. Jeff Hester et al., “Hubble Space Telescope WFPC2 Imaging of M16: Photoevaporation and Emerging Young Stellar Objects,” *The Astronomical Journal*, 111(6) (June 1996): 2349–2532; Ray Villard, oral history interview by author, 4 November 2016, pp. 1–5; DeVorkin and Smith, *The Hubble Cosmos*, pp. 63, 65, 67.
- 4 Hester OHI, 27.
- 5 Jeff Hester personal website Digital Photography Review, “TIME releases 100 most influential images of all time,” <https://www.dpreview.com/news/9721929936/most-influential-images-of-all-time> (accessed 17 November 2016); ESA-NASA Herschel website, “Revisiting the ‘Pillars of Creation,’” 18 January 2012, https://www.nasa.gov/mission_pages/herschel/news/herschel20120118.html (all accessed 2 April 2017); NASA News Release, “Hubble Goes High-Definition to Revisit Iconic ‘Pillars of Creation,’” 5 January 2015.
- 6 W. Patrick McCray, “How Astronomers Digitized the Sky,” *Technology and Culture* 55, no. 4 (October 2014): 908–44.
- 7 Travis A. Rector, Kimberley Kowal Arcand, and Megan Watzke, *Coloring the Universe: An Insider’s Look at Making Spectacular Images of Space* (Fairbanks: University of Alaska Press, 2015), pp. 52–55; Klaus Brasch, “A Short History of Astrophotography: Part 1,” *Journal of the Royal Astronomical Society of Canada* 111, no. 2 (April 2017): 52–59. Color astrophotographs had limited circulation until photographer David Malin joined the Anglo-Australian Observatory near Sydney, Australia, in 1975 and began producing colorful astronomical images.
- 8 Phil Pressel, “The Hexagon KH-9 Spy Satellite,” *Quest: The History of Spaceflight Quarterly* 24, no. 3 (2017): 13–23. For unclassified technical background on early U.S. reconnaissance satellites, see David Baker, *US Spy Satellites, 1959 Onwards (All Missions, All*

- Models*), (Sparkford, U.K.: Haynes Publishing, 2016). Hexagon flew from 1971 to 1986 and was declassified in 2011.
- 9 Smith, *The Space Telescope*, pp. 104–110; R. J. Davis, “Project Telescope: an Astrophysical Reconnaissance Satellite,” *Smithsonian Astrophysical Observatory Special Report #83* (1962); Wallace and Karen Tucker, *Revealing the Universe: The Making of the Chandra X-Ray Observatory* (Cambridge, MA: Harvard University Press, 2001), pp. 46–52; Rector, Arcand, and Watzke, *Coloring the Universe*, pp. 55–56. Vidicon imagers were also used in the Voyager spacecraft that were launched in 1977 to the outer planets, and the Einstein X-Ray Observatory and the International Ultraviolet Explorer, both launched in 1978.
 - 10 Smith, *The Space Telescope*, pp. 241–244
 - 11 Smith, *The Space Telescope*, pp. 245–253; Robert W. Smith and Joseph N. Tatarewicz “Counting on Invention: Devices and Black Boxes in Very Big Science” *Osiris* 9 (1994): 101–123, quotation from 123; Jeff Hester, oral history interview by author, 20 March 2017, pp. 17–20; NASA, “Announcement of Opportunity for Space Telescope,” AO No. OSS-1-77, 18 March 1977.
 - 12 Elizabeth A. Kessler, *Picturing the Cosmos: Hubble Space Telescope Images and the Astronomical Sublime* (Minneapolis: University of Minnesota Press, 2012), pp. 131–137, 153–157; Rector, Arcand, and Watzke, *Coloring the Universe*, pp. 55–56, 60. The Anglo-Australian Observatory has been known as the Australian Astronomical Observatory since 2010. Layering in Photoshop is useful to assemble black-and-white images shot with different filters into color images. The sales of digital cameras for personal use exceeded sales of photographic film cameras starting in 2001. At that time, digital cameras were coming into increasing use for amateur astrophotography, although they still had limitations at that time. See Terence Dickinson and Alan Dyer, *The Backyard Astronomer’s Guide, Second Edition* (Kingston, ON: Firefly Books, 2002), pp. 277, 306–319.
 - 13 Kessler, *Picturing the Cosmos*, p. 8.
 - 14 Minutes of HST Science Working Group, 35th meeting, 2–3 April 1986, Goddard Space Flight Center, with presentation on the Office of Public Affairs by Jan Wolfe, with notes by Robert W. Smith, in Johns Hopkins University, The Sheridan Libraries, Hubble Space Telescope Collection #7, Series 5, Subseries 2, Space Telescope Science Working Group meetings, Box 2, Folder 7, Space Telescope Science Working Group meeting #35, 2–3 April, 1986.
 - 15 Chaisson, *The Hubble Wars*, p. 99. Einstein was also known as the High Energy Astronomical Observatory-2. For more on Einstein, see Tucker, *Revealing the Universe*, pp. 46–52.
 - 16 Ray Villard, oral history interview by author, 30 October 2015, pp. 5–6; Zimmerman, *The Universe in a Mirror*, pp. 121–124. See also Chaisson, *The Hubble Wars*, pp. 97–106.
 - 17 David Lindley, “Space Telescope Ready at Last,” *Nature* 339 (16 March 1989): 199; Ed Weiler, personal communication with author, 3 April 2017; Neta Bahcall, oral history interview by author, 1 September 2016, pp. 9–10.
 - 18 Chaisson, *The Hubble Wars*, p. 102; Zimmerman, *Universe in a Mirror*, pp. 122–124; Letter, Bradford A. Smith to Prof. James A. Westphal, 7 August 1979, in Johns Hopkins University, The Sheridan Libraries, Hubble Space Telescope Collection #7, Series 1, Goddard Space

- Flight Center, Box 1, Folder 6, Chronological Correspondence, June–December 1979. Chaisson claimed in his book that the Voyager controversy arose because the initial discovery of Io's volcanism was not made by scientists but by Linda Morabito, a navigation engineer working in the JPL control center. According to Chaisson, this caused embarrassment to the scientists responsible for that data. The author has been unable to find evidence to back up Chaisson's claim of Morabito's work causing embarrassment, and Morabito was not using data that had been released to the public. Policies covering public release of images and other data from robotic spacecraft continue to be a lively topic of controversy. See Emily Lakdawalla, "New Horizons: Awaiting the Data," Planetary Society Blog, 19 July 2015, <http://www.planetary.org/blogs/emily-lakdawalla/2015/07181721-new-horizons-awaiting-the-data.html> (accessed 10 January 2017).
- 19 Villard OHI, 2015, pp. 4–6; Zimmerman, *Universe in a Mirror*, p. 124; Chaisson, *The Hubble Wars*, p. 101.
 - 20 Chaisson, *The Hubble Wars*, pp. 104–106.
 - 21 Section II Administrative, STScI, "II-I-2 Scientific Data Release to the General Public," undated but before 1 July 1990, STScI Archive, Box 1.5, file "STIC, 7–8 Oct 1993," JHU Library Special Collections.
 - 22 Chaisson, *The Hubble Wars*, pp. 230–231. This account is verified by Sandra Faber in her annotations in her copy of the book; David Leckrone, oral history interview by author, 6 November 2015, pp. 1–3; Villard OHI, 2015, p. 17.
 - 23 Villard OHI, 2015, p. 12. While much of the media coverage of HST operations prior to SM1 concentrated on efforts to deal with HST's problems, HST's scientific findings were also covered. See Kathy Sawyer, "Hubble Discovers Star Group," *Washington Post* (4 August 1990): A3; and John Noble Wilford, "First Hubble Findings Bring Delight," *New York Times* (30 August 1990): B10. Villard also pointed to coverage of HST releases dealing with storms on Saturn in January 1991, and aurorae on Jupiter in April 1992.
 - 24 Educational and Public Affairs Office, STScI, for NASA Goddard, "SC-06 Educational and Public Affairs Office Management Plan," 4 August 1993, STScI Archive, Box 1.5, file "STIC, 7–8 Oct 1993," JHU Library Special Collections.
 - 25 Villard OHI, 2015, p. 17.
 - 26 Paul E. Ceruzzi, *A History of Modern Computing, Second Edition* (Cambridge, MA: The MIT Press, 2003), pp. 243–306.
 - 27 Ceruzzi, *History of Modern Computing*, pp. 291–308; New Media Institute, "History of the Internet," <https://www.newmedia.org/history-of-the-internet> (accessed 30 November 2016).
 - 28 "Web History," undated form letter from NASA Public Affairs, supplied to author on 31 August 2016 by Stephen J. Garber, NASA Headquarters History Program Office.
 - 29 AURA and STScI, proposal documents for "Hubble Access: Public and Educational Benefits from the Hubble Space Telescope," 9 May 1994, STScI Archive, Box 4.3, file "STIC, 7–8 Oct 1993," JHU Library Special Collections. See also memo, Ray Villard to Robert Williams, "Strategic Plan STScI Public Affairs Activities: Preliminary Draft," 8 April 1994,

- STScI Archive, Box 1.5, file “Memos, policy documents, correspondence, e-mails etc., 1991–2000,” JHU Library Special Collections.
- 30 John R. Spencer and Jacqueline Mitton, eds., *The Great Comet Crash: The Collision of Comet Shoemaker-Levy 9 and Jupiter* (Cambridge, MA: Cambridge University Press, 1995), pp. 41–44.
 - 31 C. A. Christian and A. Kinney, *The Public Impact of Hubble Space Telescope: Office of Public Outreach Monograph Series*, Number 102 STScI, February 1999; Villard OHI, 2016, p. 9. Although the release of the “Pillars of Creation” image doubtless was also popular on the internet, it was not mentioned in the report. The first HST image the author ever downloaded from a NASA or STScI website was the “Hubble Deep Field.” Like many other people, the author had purchased his first personal computer with color graphic capabilities in 1995. This report and many others from the 1990s and 2000 quoted in this article used “hits” to quantify usage of the web, but a hit on the web is different from a “page view,” “site visit” or “user session,” measurements that have become more commonly used since that time. The use of a single web page can involve several “hits” because each graphical feature on a web page is counted as a “hit.” Thus, looking at a web page with six images on it would count for six hits.
 - 32 Space Telescope Science Institute, *Annual Report 2000* (Baltimore, MD: STScI, April 2001): p. 42. See also Office of Public Outreach, STScI, “Implementing the 2002–2007 Strategic Plan for the Office of Public Outreach,” STScI Archive, Box 2.2, file “STScI Strategic Planning, 1995–2005,” JHU Library Special Collections. NASA website, “The Hubble Space Telescope Inspires Wonder: Education Resource Page,” <https://www.nasa.gov/audience/foreducators/hubble-index.html> (accessed 4 April 2017); ESA Hubble Space Telescope website, <https://www.spacetelescope.org/about/> (accessed 9 October 2017).
 - 33 When the author checked Twitter accounts on 1 August 2019, the @NASAHubble Twitter account had 6.5 million followers, and the @MarsCuriosity account had 4 million followers. The main @NASA Twitter feed had 32.1 million followers. See also “Get the Hubble Telescope on your iPhone, iPad—Download Free Hubblesite App,” <http://news.softpedia.com/news/Get-the-Hubble-Telescope-on-Your-iPhone-iPad-Download-Free-Hubblesite-App-184482.shtml> (accessed 9 October 2017). For more on HST and the internet, see Christopher Gainor, “The Hubble Space Telescope in Cyberspace,” *Quest: The History of Spaceflight Quarterly* 24, no. 2 (2017): 4–12.
 - 34 STScI records, “Scientific Data Release to General Public”; Zoltan Levay, oral history interview, pp. 6–10; Villard, e-mail communication with author, 9 October 2017; Levay, e-mail communication with author, 2 February 2018. Levay said Photoshop wasn’t the first program of its type used at STScI because it was not compatible with the FITS format used for HST images, but it began being used around 1994.
 - 35 Hester OHI, 29.
 - 36 Levay OHI, pp. 2–3; Keith Noll, oral history interview with author, 15 May 2017, part 1, pp. 2–3; Kessler, *Picturing the Cosmos*, pp. 112–125; Zoltan Levay, “Creating Hubble’s Imagery,” in Roger D. Launius and David H. DeVorkin, eds., *Hubble’s Legacy* (Washington, DC: Smithsonian Institution Scholarly Press, 2014), pp. 112–119; Robert Williams, oral history interview by author, 21 May 2015, part 2, p. 14; Draft proposal for the Hubble Heritage Project contained in e-mail “revised proposal” from Keith Noll to Anne Kinney,

- Howard Bond, and Carol Christian, 28 February 1997. See also Elizabeth Kessler, “The Wonder of Outer Space,” in David DeVorkin and Robert W. Smith, eds., *Hubble: Imaging Space and Time* (Washington, DC: National Geographic Society, 2008), pp. 138–144; and Keith S. Noll, Principal Investigator, “Continuation of the Hubble Heritage Project,” Cycle 11 Proposal for HST Time, STScI, 2002.
- 37 Elizabeth Kessler, “The Hubble’s Anniversary,” *Quest: The History of Spaceflight Quarterly*, vol. 17, no. 2 (2010), pp. 34–43. The *60 Minutes* story on HST first appeared on the CBS news show on 6 October 2002. See also Ray Villard and Zoltan Levay, “Creating Hubble’s Technicolor Universe,” *Sky & Telescope* (September 2002): 28–34; and Travis A. Rector et al., “Image Processing Techniques for the Creation of Presentation-Quality Astronomical Images,” *The Astronomical Journal* (February 2007): 133, 598–611.
- 38 Rector, Arcand, and Watzke, *Coloring the Universe*, p. 61.
- 39 Hussein Jirdeh, e-mail to author, 26 October 2017; Zoltan Levay, e-mail to author, 10 October 2017; Noll OHI part 1, pp. 7, 12–14. Levay, who continued to produce new images and animations at STScI until his retirement in 2018, said in 2017 that the Institute’s Office of Public Outreach, where he worked, continued to request time on HST for observations to support public outreach.
- 40 Rector, Arcand, and Watzke, *Coloring the Universe*, pp. 2–8.
- 41 Villard and Levay, “Creating Hubble’s Technicolor Universe,” p. 30. Emphasis in original.
- 42 Villard and Levay, “Hubble’s Technicolor Universe,” pp. 28–34.
- 43 Villard and Levay, “Hubble’s Technicolor Universe.”
- 44 Levay, “Creating Hubble’s Imagery,” p. 116.
- 45 Villard and Levay, “Hubble’s Technicolor Universe”; Levay, “Creating Hubble’s Imagery”; Buddy Nelson, *Hubble Space Telescope Servicing Mission 4 Media Guide* (Lockheed Martin, 2009), pp. 4–3.
- 46 Rector, Arcand, and Watzke, *Coloring the Universe*. pp. 189–190; Hester OHI, pp. 27–28.
- 47 Allison M. Heinrichs, “PR With Universal Appeal,” *Los Angeles Times* (5 September 2003): A1.
- 48 Villard OHI, pp. 30–31.
- 49 Elizabeth A. Kessler, “Displaying the Beauty of the Truth: Hubble Images as Art and Science,” from Launius and DeVorkin, *Hubble’s Legacy*, pp. 120–130.
- 50 Elizabeth A. Kessler, *Picturing the Cosmos*, pp. 50–59.
- 51 *Ibid.*, p. 181.
- 52 *Ibid.*, p. 4.
- 53 STScI, “NASA’s Great Observatories Begin Deepest Ever Probe of the Universe,” news release STScI-2013-44, 24 October 2013.
- 54 STScI, “The Dawn of a New Era for Supernova 1987A,” news release STScI-2017-08, 24 February 2017. FITS is discussed in chapter nine.
- 55 W. Patrick McCray, *Giant Telescopes: Astronomical Ambition and the Promise of Technology* (Cambridge, MA: Harvard University Press, 2004), pp. 146–147, 153–159; Association

of Universities for Research in Astronomy, *Space-based vs. Ground-based Telescopes with Adaptive Optics (AO)*, summary prepared by staff at STScI, 2010.

- 56 *Contact*, directed by Robert Zemeckis (Warner Brothers DVD, 1997); IMAX *Hubble*, directed by Toni Myers (Warner Brothers DVD, 2010). The IMAX *Hubble* film is also shown in 3D format.



CHAPTER FIVE

New Instruments and New Directions

▲ Hubble's Wide Field Camera 3 captured this view of the Lagoon Nebula in February 2018. (NASA/ESA/STScI: STSCI-H-p1821a)

The Hubble Space Telescope stands apart from other robotic spacecraft because of the many upgrades it underwent during its first two decades on orbit. Hubble's design as part of the U.S. Space Shuttle Program permitted regular replacement of its suite of scientific instruments by improved new instruments with new characteristics. It also made possible the full set of repairs and modifications that took place in the first Hubble Servicing Mission in 1993 to overcome HST's unexpected spherical aberration problem. Four more Shuttle servicing missions to HST followed, and this chapter will explore how HST evolved as an observatory and as a spacecraft through three of those servicing missions. Like the first servicing mission, the circumstances surrounding the final servicing mission in 2009 are so extraordinary that it requires its own chapter. Each of Hubble's servicing missions has a distinct story, and together the HST servicing missions constitute the first serious effort to service, maintain, update, and repair a robotic spacecraft in its operating environment. The success of these missions also constitutes an important step in preparations to build the International Space Station and, in all probability, future spacecraft and space stations.

INFRARED ASTRONOMY MATURES

Even before the 1993 servicing mission that restored its focus and its future, HST was operating nearly full time obtaining scientific data using its original set of instruments—two spectrographs and two imaging instruments operating in ultraviolet, visible, and in near infrared wavelengths, along with a photometer

and the astrometric measurement capability contained in HST's Fine Guidance Sensors. The spectrograms and images in all wavelengths provided new information about the properties of celestial bodies of all types. A major reason for observatories and telescopes in space is to give scientists the ability to make observations in wavelengths that can't be seen from Earth, such as the limited ultraviolet and infrared wavelengths that HST could detect. The Orbiting Astronomical Observatories and the International Ultraviolet Explorer helped establish ultraviolet astronomy.¹ Growing numbers of astronomers expressed interest in infrared astronomy in the years that HST was being built because many objects that are concealed by dust in visible light are visible in the infrared. And light from distant objects shifts to the red part of the spectrum as the objects recede in relation to Earth. But infrared astronomy has proven difficult because telescopes must operate at extremely low temperatures so that heat radiating from the instrument does not interfere with infrared radiation from low-temperature objects. Telescopes like HST that operate on the fringes of Earth's atmosphere are also affected by infrared radiation emitted from Earth, but they could make observations in some infrared wavelengths. The first promising results from infrared instruments came in 1971 from NASA's Kuiper Airborne Observatory, which began taking infrared data from a telescope mounted in a converted Lockheed C-141 aircraft. Infrared astronomy received another boost in 1983 when the Infrared Astronomical Satellite operated for most of a year until its coolant ran out, but not before providing surprising results about the life cycles of stars and the nature of galaxies.²

The work that led to the first changes to HST's lineup of instruments began six years before it was launched. As discussed in chapter three, a team at the Jet Propulsion Laboratory had begun work on the second Wide Field Planetary Camera in 1984 shortly after HST Program Scientist Ed Weiler proposed it. John Bahcall, one of the driving forces behind HST, had advocated strongly for an infrared capability for Hubble, but in the words of HST Project Scientist David Leckrone, the state of infrared detectors was "primitive" when NASA chose the first generation of HST instruments in 1977, two of which had capability in near infrared wavelengths. Indeed, panelists assessing proposals for those first-generation instruments rejected a proposal for an infrared instrument because the detector was not judged as being effective.³ In October 1984, NASA issued an Announcement of Opportunity for "three to six" second-generation science instruments for HST. While the announcement did not suggest what type of instruments might be proposed, it did highlight the fact that HST could accommodate a cryogenically cooled infrared instrument.⁴ A 16-member committee assessed the eight proposals for instruments that came in response to

the Announcement of Opportunity (AO) at a time when better detectors were becoming available. “They also provided unsolicited advice on the relative priorities of various classes of instruments,” Weiler wrote. “Although the team was primarily composed of ultraviolet and visible light experts, they rated an infrared camera/spectrometer as the number one priority,” reflecting the growing interest in infrared astronomy, and an ultraviolet/visible spectrograph second. In December 1985, NASA announced that two proposals for an infrared instrument would be considered for further study—the Near Infrared Camera and Multi-Object Spectrometer (NICMOS) proposed by Rodger Thompson of the University of Arizona, and the Hubble Imaging Michelson Spectrometer (HIMS) proposed by Donald Hall of the University of Hawaii. Also getting the nod for further study was the Space Telescope Imaging Spectrograph (STIS) proposed by Dr. Bruce Woodgate of the Goddard Space Flight Center, which featured advanced detectors and would satisfy the second priority for an ultraviolet instrument. Although NASA originally planned to allow NICMOS and HIMS to proceed through Phase A and Phase B studies before a choice was made, it decided in 1987 to accelerate the decision process when the two Principal Investigators thought enough progress had been made. Because of the very limited near infrared capability in the original set of HST instruments, scientists who reviewed the instrument proposals urged NASA to get an infrared instrument on HST as soon as possible.⁵ In 1988, a NASA peer review team chose NICMOS over HIMS because it saw NICMOS’ block of solid nitrogen as the best way to cool its detectors for infrared observations and because of the strength of its research team. The other instrument selected, STIS, was seen as a capable replacement for both the first-generation spectrographs, the Goddard High Resolution Spectrograph (GHRS) and the Faint Object Spectrograph (FOS). Replacing them both could free up an instrument bay inside HST. STIS also contained highly advanced Multi-Anode Microchannel Array (MAMA) digital detectors that had been under development since the early 1970s.⁶

SECOND-GENERATION INSTRUMENTS

When work commenced in 1989 to build NICMOS, both STIS and WFPC2 were already being built, and NASA had penciled them in for installation on HST during the first Shuttle servicing mission to HST, with NICMOS likely following in the second servicing mission. But these plans were thrown into question when HST’s spherical aberration problem was discovered in June 1990.⁷ As outlined in chapter three, NASA quickly decided to modify WFPC2 to deal with spherical aberration, and that fall, COSTAR emerged as a means of compensating for the problem as it affected three other instruments. WFPC2 and

COSTAR were installed on HST during SM1 in 1993. To stay within NASA's tight budget, HST managers considered postponing STIS to the third servicing mission in 1999 and reducing NICMOS to a simple near infrared camera instrument. In the end, the spectrographic capabilities of NICMOS were simplified and reduced to stay within the smaller budget, but not so much that it required a name change. The capabilities of STIS were also reduced to save money when NASA opted to remove one of its detectors and reduce the sizes of the other three detectors. HST management put STIS and NICMOS on the Shuttle launch manifest for the second servicing mission in 1997.⁸

With new instruments chosen for installation on HST in SM2, scientists and NASA officials had to decide what instruments they would displace. Discussions between managers at the HST project science office at Goddard, the HST program office at NASA Headquarters, and STScI in 1994 had led to the tentative decision that the two first-generation spectrographs, GHRS and FOS, should be removed for NICMOS and STIS because STIS' capabilities would replace both spectrographs. NASA and STScI also planned to replace the Faint Object Camera (FOC) with the Advanced Camera for Surveys during the third servicing mission in 1999. Leckrone told an HST Servicing Science Working Group meeting in February 1995 that electrical problems with FOC were causing scientists and program officials to reconsider their instrument replacement plans. If NASA changed them and removed FOC in 1997 instead of 1999, it could leave HST's imaging capabilities dependent on a single instrument: WFPC2. As long as the FOC remained aboard HST, COSTAR would have to remain as well. He added that since FOC was part of Europe's contribution to HST, any decision to remove it would be politically sensitive. NASA's existing plan also had a downside: removing GHRS and FOS would leave STIS as the only spectroscopic instrument on HST, which could become a serious problem if STIS failed. Despite these concerns, the meeting supported the existing instrument replacement plans for the upcoming two servicing missions, and NASA decided that the second servicing mission would feature replacement of GHRS and FOS with STIS and NICMOS.⁹

These two new instruments were equipped with corrective optics to compensate for the spherical aberration in the main mirror. Both were manufactured by Ball Aerospace of Boulder, Colorado, which had already made GHRS and COSTAR for Hubble. STIS's detectors had a two dimensional capability that meant they could record data from the entire length of a slit instead of a single point, giving them the ability to gather data on multiple objects simultaneously. This also meant they could collect about 30 times more spectral data and 500 times more spatial data than the simpler single point detectors

on GHRS and FOS. In addition to a CCD detector, STIS contained two of the sophisticated MAMA detectors that were specially designed to operate exclusively in space in ultraviolet wavelengths. With its powerful suite of detectors, STIS could search for massive black holes by examining the movement of stars and gas near the centers of galaxies, use its high sensitivity to study stars forming in distant galaxies, and perform spectroscopic mapping.¹⁰

NICMOS used three photodiode detectors to make images and spectrographic observations of astronomical targets and extend HST's vision to the far reaches of the universe by giving astronomers their first high-definition data in near infrared wavelengths. Infrared instruments can detect very distant galaxies, which are moving away from us and thus their light is shifted toward the infrared. Because of their great distances these galaxies are also viewed as they were at an earlier time, and the most distant objects are therefore seen early in the existence of the universe. The infrared detectors in NICMOS operate at very low temperatures of about minus 355° F (minus 215° C), and were kept cold inside a cryogenic Dewar containing about 240 pounds of frozen nitrogen designed to last for about four and a half years, which was the planned lifetime for the instrument. NICMOS included three different cameras, each with its own field of view and resolution, and each equipped with filters and optical components that make NICMOS a spectrometer and a coronagraph, which allowed the instrument to image dim objects near bright objects.¹¹

PREPARING FOR SM2

Another major goal of Servicing Mission 2 was to replace one of Hubble's Fine Guidance Sensors (FGS). Three of these assemblies were launched aboard the telescope in 1990, and while their main function was to help guide HST and keep it locked on target, one was always designated to act as a sixth science instrument for high precision measurement of celestial object positions, or astrometry. The three Fine Guidance Sensors, which can be compared in shape and size to baby grand pianos, are positioned at 90 degrees to each other in the telescope's radial bay just below the main mirror and alongside HST's main camera—at the time WFPC2.¹²

Perkin-Elmer had built four FGS units, including an engineering test unit. When two of the FGS units on HST began to show mechanical wear problems in advance of the second servicing mission, NASA decided to replace FGS2 with the engineering test unit, which had been refurbished by the contractor. In the final months before SM2, FGS1 began to appear to be closer to failing than FGS2, so NASA decided to replace FGS1 with the refurbished unit. The Fine Guidance Sensors also suffered some slight degradation in performance due to

▶ The STS-82 crew poses following completion of five spacewalks to service the Hubble Space Telescope (HST) in February 1997. Pictured left to right are Joseph R. Tanner, Steven A. Hawley, Mark C. Lee, Kenneth D. Bowersox, Steven L. Smith, Scott J. Horowitz, and Gregory J. Harbaugh. Each astronaut is wearing a shirt bearing an image of a celestial body photographed by the giant observatory. (NASA: s82e5948)



▶ STS-82 crew insignia. (NASA)



▶ SM2 insignia from GSFC. (NASA)

◀ Astronaut Mark C. Lee (top), on the end of the Remote Manipulator System (RMS) arm, performs a patch task on the worn insulation material of the Hubble Space Telescope (HST). Astronaut Steven L. Smith assists with the patch work. (NASA: sts082-325-034)

the spherical aberration in HST's main mirror, which caused a small misalignment of light inside each FGS unit. This problem was reduced by installing an articulating mirror assembly in each replacement unit. Once installed on HST, the refurbished unit became known as FGS1r and was the only FGS used for astrometric work on HST.¹³

The mission was also slated to replace one of HST's three reel-to-reel engineering and science data recorders with a new solid-state recorder capable of recording 12 gigabits, ten times the capacity of the original recorders. Also to be replaced were one of HST's four Reaction Wheel Assemblies, one of Hubble's two solar array drive electronics units, and covers for HST's magnetometers. The astronauts of the second servicing mission were provided with more than 300 different tools and aids, including some developed based on the lessons of the previous mission, including a pistol grip tool that answered the STS-61 crew's call for a smaller more efficient tool for precision work during EVAs.¹⁴

Having learned the importance of advance preparation from the first servicing mission, NASA named the four spacewalking astronauts for the second HST servicing mission on 31 May 1995, nearly two years ahead of launch—Marc C. Lee, Steven L. Smith, Joseph R. Tanner, and Gregory J. Harbaugh. All had flown in space before, and Lee and Harbaugh had spacewalking experience. Harbaugh had also served as the backup EVA astronaut for the first servicing mission. A few months later NASA filled out the crew with another three experienced astronauts: commander Ken Bowersox, a veteran of SMI, Scott J. Horowitz as pilot, and Shuttle robotic arm operator Steven A. Hawley, who had last flown on the mission that deployed HST in 1990. Hawley returned to flight status on SM2 from a stint in NASA management.

Like the first HST servicing crew, the EVA crew of STS-82 began long hours of training for their four scheduled EVAs in the water tanks at the Marshall Space Flight Center and the smaller Weightless Environment Training Facility at Johnson Space Center. With construction of the International Space Station due to begin in 1998, NASA decided earlier in the decade that the Marshall facility and the WETF were much too small to properly train crews for the ISS, and were even a tight fit for crews preparing for missions to HST. NASA built the Neutral Buoyancy Laboratory at the Sonny Carter Training Facility near JSC, and the crew of STS-82 became the first to train inside its 6.2-million-gallon pool in the final weeks before flight. Hawley noted that the training he did for arm operations on STS-82 was much more realistic than for the HST deployment mission seven years earlier. Virtual reality training, which became even more important for training for the ISS, was used to prepare astronauts to handle large masses such as STIS,

NICMOS, and the FGS. Ground trainers at Goddard and elsewhere were used to prepare astronauts for difficult tasks.¹⁵

AN UPGRADE MISSION

STS-82 built on the experience of its famous servicing predecessor mission, STS-61, but there was an important difference, as Hawley explained, “Whereas STS-61 was a repair mission, STS-82, Servicing Mission 2, was an upgrade mission.”¹⁶ The mission began at the scheduled date and time when the Shuttle Discovery departed Launch Complex 39A at Kennedy Space Center at 3:56 a.m. EST on 11 February 1997. Two days later, Hawley grabbed HST with the robotic arm and berthed it in the Flight Support System fixture in Discovery’s payload bay. Hawley noticed that Hubble looked “weathered” since he had last seen it seven years earlier, with the solar arrays marked by impacts from micro-meteoroids and orbital debris. The solar array damage was expected because

Space Telescope Imaging Spectrograph (STIS)

Time on HST:

13 February 1997–present

Contractor:

Ball Aerospace

Principal Investigator:

Bruce Woodgate (GSFC)

Weight: 318 kilograms

(700 pounds)

Axial Instrument

Space Telescope Imaging Spectrograph

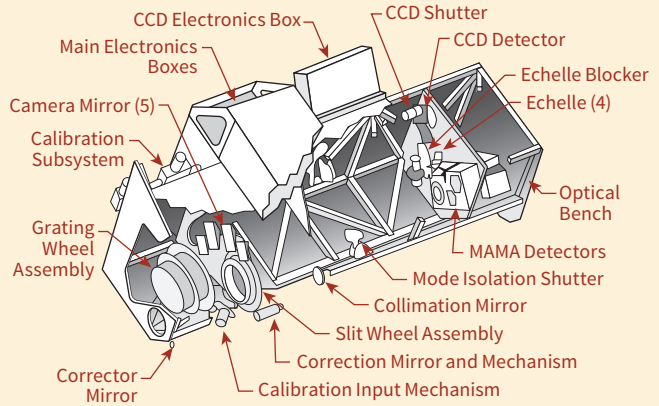

Work on the Space Telescope Imaging Spectrograph goes back to the 1970s, when development began on Multi-Anode Microchannel Array (MAMA) digital detectors for use in spectrographs attached to space telescopes. STIS was originally slated to be installed on HST during the first servicing mission, but this was put back to SM2 as a result of the decisions to install WFPC2 and COSTAR on Hubble during SM1.

the solar array returned from the first servicing mission showed evidence of more than 80,000 particle impacts from its 43 months on orbit.¹⁷

The next day Hawley and Tanner were surprised while depressurizing Discovery's new exterior airlock, which had been installed before the flight during a major upgrade. Air passing through an airlock vent pointing toward HST caused the solar arrays to rotate more than 90 degrees, but their fears that the arrays were damaged proved unfounded. The solar array rotation added to controllers' and astronauts' concerns about the flexible arrays, which like the original arrays, appeared susceptible to damage during EVAs and Shuttle maneuvers. Mission control decided to allow the first EVA to proceed. Astronauts Lee and Smith installed STIS and NICMOS after removing GHRS and FOS. The next day, Harbaugh and Tanner changed out the troubled Fine Guidance Sensor 1 with the refurbished FGS test unit, and they installed an Optical Control Electronics Enhancement Kit to improve the operation of the

STIS's internal optics are designed to compensate for the effects of spherical aberration in HST's main mirror.^a

STIS is equipped with three 1,024 by 1,024 detectors operating from the ultraviolet to the near infrared, 1,150 to 10,300 angstroms. It is used for a variety of investigations, including galactic nuclei and galactic nebulae. One detector is a CCD, and two others are MAMA detectors operating in ultraviolet wavelengths, one in the near ultraviolet and the other in the far ultraviolet. While STIS can be used at the same time as other instruments, only one of its detectors can be used at a time. STIS has 15 spectroscopic modes for use in a variety of ultraviolet and visible wavelengths.^b

STIS experienced a power supply failure in August 2004, and after nearly five years of suspended operations, it was repaired in May 2009 in Servicing Mission 4. Its detectors have operated well since that time.

STIS has imaged aurorae on solar system planets such as Jupiter, Saturn, and Uranus; obtained ultraviolet spectra of distant supernovae, galaxies and nebulae; and searched for evidence of black holes.

a J. Gethyn Timothy, "Review of Multianode Microchannel Array Detector Systems," *Journal of Astronomical Telescopes, Instruments, and Systems* 2 no. 3, 030901 (July–September 2016).

b Space Telescope Science Institute, *Space Telescope Imaging Spectrograph Instrument Handbook for Cycle 24, Version 15.0* (Baltimore, MD: STScl, January 2016).

new FGS. They also changed out an Engineering and Science Tape Recorder with a backup tape recorder. Before Harbaugh and Tanner ended their EVA, commander Bowersox and pilot Horowitz fired Discovery's steering jets to raise HST's altitude by 2 miles (3.2 kilometers) to compensate for drag on HST from the atmosphere even at that altitude. The two spacewalking astronauts remained in the Shuttle's payload bay, tethered and holding on to a railing, in case the burn caused Hubble's solar arrays to bend, which didn't happen.¹⁸

During EVA three, Lee and Smith replaced a Data Interface Unit with an upgraded unit, an Engineering and Science Tape Recorder with a solid state recorder, and one of the four Reaction Wheel Assemblies that use spin momentum to move the telescope toward a target and maintain it in a stable position. The 7-hour, 11-minute spacewalk also included another burn to raise HST's orbit, and time for the astronauts to inspect HST's thermal insulation. After the EVA, Mission Control decided to add a fifth spacewalk to repair some of the multi-layered insulation that had degraded and cracked from exposure to the low-Earth orbit space environment. This included sunlight unfiltered by the atmosphere and the effects of atomic oxygen, which even at Hubble's high altitude can damage many materials. The broken insulation raised concerns that pieces could enter the telescope and cause uneven heating of HST systems that could damage them.¹⁹

Harbaugh and Tanner replaced an electrical drive unit for one of the solar arrays and installed new thermal covers over the telescope's magnetometers during the fourth spacewalk, replacing the jury-rigged covers that had been assembled and installed during the STS-61 mission. Before their STS-82 spacewalk ended, Harbaugh snapped a photo of Tanner with the Sun, Earth, and part of Discovery in the background, which became one of the better-known astronaut photos of the Shuttle Program. During that spacewalk, Horowitz and Lee assembled some insulation blankets of their own inside Discovery's cabin, and during the fifth and final EVA of the mission, Lee and Smith attached the new blankets to three equipment compartments on Hubble. While HST was attached to Discovery, Bowersox and Horowitz fired the Shuttle's thrusters a third time to raise its orbit and that of HST. Once the repairs were completed, Hawley released HST to fly free in its own orbit. Discovery and its crew returned to Kennedy Space Center on 21 February after 10 days in space.²⁰ STS-82 added to NASA's experience base for the ISS, which began operations late the following year. Tanner, who went on to carry out EVAs in two ISS construction missions, explained that during STS-82, both astronauts in each spacewalk stayed together during every task, while during his ISS spacewalks, NASA's confidence had grown to the point where spacewalking

astronauts were allowed to carry out different work at different locations at the same time. “We probably could have done more tasks if we’d split, but we weren’t comfortable enough as an organization at that time to multitask on HST. We did it all the time on station later, but we were all more mature in our abilities by that time.”²¹

With its emphasis on installing new instruments and upgrading HST, STS-82 lived up to the hopes NASA had for Hubble servicing missions. When the mission returned to Earth, the engineers and technicians who made it possible began preparations for the third servicing mission. Scientists calibrated the newly installed instruments, STIS and NICMOS, and began to obtain data using the new capabilities these instruments offered. After the three years of relatively smooth operation that marked the three years between the first and second servicing missions, the months that followed SM2 offered some unhappy surprises.

PROBLEMS AND PREPARATIONS

STIS and NICMOS both remained onboard Hubble for the rest of its operational life. STIS got off to a good start and remains operational at the time of writing, although power supply failures meant that it was shut off from 2004 to 2009, when astronauts repaired it. STIS has been used for many research programs, including successful searches for black holes at the centers of galaxies, learning about the evolution of clouds of hydrogen gas in the areas between galaxies, making the first direct chemical analysis of the atmosphere of an exoplanet, and finding evidence for water in the Jovian moons Europa and Ganymede.²² NICMOS was a different story. When NICMOS began its long-awaited observations in the infrared, it soon became clear that the instrument was suffering from a thermal short that had the effect of warming the frozen nitrogen at a faster rate than planned. This meant that the instrument would only be useful for about a year and a half. AURA organized an independent science review at NASA’s request in May 1997, and the review recommended that since early observations from NICMOS had already shown scientific promise, further NICMOS observations should be given priority while the frozen nitrogen supply was still available. Goddard engineers proposed that a new type of mechanical cooler known as a Reverse Brayton Cycle Cryocooler for NICMOS be tested and installed, an idea that was endorsed by the review because of the scientific value of NICMOS and the low estimated cost of the new system, about \$6 million, compared to the money already spent on NICMOS, about \$105 million. Based on those recommendations, NASA proceeded with work on a cryocooler for installation in an upcoming servicing mission.²³



▲ The seven STS-95 crew members pose for their in-flight crew portrait. Astronaut Curtis L. Brown, Jr., commander, appears at right center in the pyramid. Others, clockwise from there, are Steven W. Lindsey, pilot; Stephen K. Robinson, mission specialist; Pedro Duque, mission specialist representing the European Space Agency (ESA); payload specialist Chiaki Mukai, who represents Japan's National Space Development Agency (NASDA); Scott E. Parazynski, mission specialist; and United States Senator John H. Glenn, Jr. (D-OH), payload specialist. (NASA: sts095-328-031) **Inset:** STS-95 crew insignia. (NASA: sts095-S-001)

To test the new cryocooler in the environment of low-Earth orbit along with other components destined for HST, Goddard's HST Flight Systems and Servicing Project Manager Frank Cepollina suggested the creation of the HST Orbital Systems Test (HOST) platform. A team he assembled at Goddard worked long hours for 16 months preceding the launch of the Shuttle Discovery from pad 39B at KSC on 29 October 1998. The 10-day flight of STS-95 would have passed with little public notice if the crew had not included the first American to orbit Earth, Senator John H. Glenn, Jr. At age 77, Glenn became the oldest person to fly into space when he launched on Discovery 36 years after his first flight in the Mercury program, and he served as the subject of several life sciences experiments. Inside the HOST unit that was located in Discovery's payload bay, the cryocooler passed its test in the harsh conditions of space and was cleared for installation on HST. HOST also flew a new computer based on Intel 80486 processor technology, with twice the memory and three times the speed of the Intel 80386 coprocessor installed on HST during the first servicing mission. That coprocessor had increased the available memory by 32 times and

processor speed 13 times over HST's original DF-224 computer. While personal computers based on 486 chips were already passing out of fashion in the late 1990s, the 486 was well known and well tested in the eyes of NASA. HST's new computer passed a battery of tests on Earth and its test in space on HOST to verify that it would function properly in the radiation environment of Earth orbit. HOST also carried a solid-state recorder on board similar to the recorder installed on SM2, which had shown errors thought to be caused by high-energy protons that are present at HST altitudes in the South Atlantic Anomaly, where the inner Van Allen radiation belt comes closest to Earth. Although STS-95 flew in a lower orbit than HST, the two radiation environments and their effect on the recorders could be compared, and the newer recorder was deemed to be fit for installation on HST.²⁴

With the successful conclusion of the HOST mission late in 1998, NASA turned to preparations for the third Hubble servicing mission. Earlier that year in July, NASA announced that four astronauts were assigned to carry out a record-breaking six EVAs during the STS-104 mission, which was scheduled for flight on Columbia in May 2000. Steven Smith, a veteran of SM2, was named payload commander. Other spacewalkers named for the mission were Michael C. Foale, who had recently completed a long-term flight on the Mir Space Station; ESA astronaut Claude Nicollier, who had operated the Shuttle's robotic arm during the first HST servicing mission; and John M. Grunsfeld, an astronomer with two Shuttle flights to his credit. This assignment began Grunsfeld's long association with HST as an astronaut, NASA official and astronomer. Plans for the mission included installing a new science instrument, the Advanced Camera for Surveys (ACS), on board HST in the place of the FOC, and installation of a refurbished Fine Guidance Sensor and new solar arrays, along with the equipment tested on the HOST unit.²⁵ But as NASA prepared for SM3, a familiar but more urgent problem reared its head on board Hubble. The telescope's six gyroscopes, which were needed for HST and its controllers to know which way it was pointing, were operating well at the time of SM2 in 1997. But one of the gyros failed later that year, followed by another in 1998. Early in 1999, a third gyroscope began acting abnormally. HST was not designed to operate properly with fewer than three gyroscopes. Each gyroscope contains a wheel that spins at 19,200 rpm enclosed inside a sealed cylinder floating inside a liquid with the thickness of motor oil. The wheel gets its power from extremely thin wires that pass through the fluid. In the failed gyroscopes, NASA engineers concluded that the fluid corroded the wires and caused them to break because the air used to force the fluid into the instrument cavity contained oxygen. By using nitrogen rather than air in the future, engineers hoped to avoid corrosion in newer gyroscopes flying on HST.²⁶

On 10 March 1999, NASA announced that the work of the third servicing mission would be divided into two missions designated as servicing missions 3A and 3B, and that the first would fly to HST in 1999 to perform the most critical repairs such as replacing all six gyroscopes, a Fine Guidance Sensor, and HST's computer. "When Hubble reached the point of having no backup gyros, our flight rules said we must look at what we term a 'call-up mission' to correct the situation," said John H. Campbell, the HST program manager at NASA Goddard. Since preparations for a servicing mission were already well under way, he said HST managers decided that the best thing to do was to divide the next servicing mission into two missions, with one moved ahead on the schedule into 1999.²⁷ NASA had created plans for what were also known as Launch on Need Shuttle missions, generally using the hardware from a mission being processed for the next regular mission for a special purpose. NASA developed four of these plans during the early days of the Shuttle Program, including two believed to be for national security needs involving the Shuttle. A third Launch on Need mission was designated to "restore the capability" of HST, and a fourth was planned for contingencies during space station missions.²⁸ Two days after NASA announced the flight of Servicing Mission 3A, also designated as STS-103, it named a flight crew for the mission, including the four EVA astronauts already in training for the next Hubble servicing mission. NASA also selected Curtis L. Brown, Jr., a veteran of five Shuttle missions, including the HOST mission, as mission commander, rookie Scott J. Kelly as pilot, and experienced ESA astronaut Jean-Francois Clervoy as arm operator.²⁹

A SHUTTLE RESCUE MISSION

At the time it was announced, HST Servicing Mission 3A was scheduled to fly in October 1999, but this flight faced an unprecedented series of complications that started when inspectors discovered wiring problems inside Columbia after it had launched the Chandra X-Ray Observatory in late July, causing the entire Shuttle fleet to be grounded for months while the problems were investigated and fixed. The hurricane season that fall also complicated launch preparations for SM3A. By the time HST's fourth gyroscope failed on 13 November, putting HST into safe mode and forcing a halt to HST science operations, the launch of STS-103 on Discovery had slipped to 6 December. With HST's deteriorating condition, NASA was anxious to get this flight completed as soon as possible, and in the words of Scott Kelly, "It was mentally draining to keep working toward a date that slipped away, then bring our full energy to the next announced date." The upcoming holiday season added a complication unlike any other: Because the year would roll over from 1999 to 2000, NASA had

► The seven astronauts of STS-103 during their flight to service HST in December 1999. In front are, left to right, Claude Nicollier, Scott J. Kelly, and John M. Grunsfeld. Behind them are astronauts Steven L. Smith, C. Michael Foale, Curtis L. Brown, Jr., and Jean-Francois Clervoy.

(NASA: sts103-397-035)



◀ SM3A insignia from GSFC. (NASA)

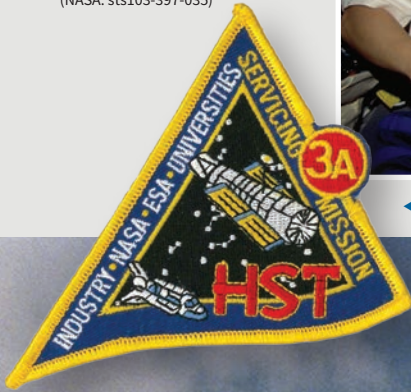

► STS-103 crew insignia. (NASA)



◀ Space Shuttle Discovery, atop the mobile launcher platform and crawler transporter, nears the top of Launch Pad 39B after the trek from the Vehicle Assembly Building. (NASA: KSC-99pp1305)



to deal with widespread concern in government and industry about computer program operations. Many computer programs used only two digits to designate the year, not anticipating the problems that could arise if a computer got the year 2000 mixed up with 1900. NASA decided that the Shuttle must not be flying or even be powered up when the year changed to avoid what was popularly known as the Y2K bug.³⁰ While most Shuttle Program computers had been updated to protect against the Y2K bug, that did not include equipment at the backup Shuttle landing site at Edwards Air Force Base. SM3A was originally planned to include four spacewalks during a flight of 10 days duration. Further problems with Discovery's wiring and propellant lines delayed the launch to 18 December, and at that point NASA management cut the mission to eight days with only three EVAs to make sure it got home before the New Year. Due to a one-day weather delay that nearly caused NASA to postpone the mission to January, the mission of STS-103 didn't launch from Pad 39B at KSC until 7:50 p.m. EST on 19 December 1999.³¹

Two days later, Discovery and its crew caught up with the stricken Hubble, and Clervoy used the remote manipulator arm to berth the space telescope on the Flight Support System inside the Shuttle's payload bay. Smith and Grunsfeld performed the first spacewalk the next day, successfully changing out the three Rate Sensor Units containing HST's six gyroscopes. The two astronauts also installed six Voltage/Temperature Improvement Kits to prevent overcharging of HST's six batteries, and then opened coolant valves on NICMOS to ensure that all of its nitrogen coolant was purged in preparation for work on the instrument during the next servicing mission. The EVA lasted eight hours rather than the scheduled six hours. "All along the way...we encountered various small problems with bolts that were frozen, boxes that didn't fit right, and doors that were tough to close," Grunsfeld explained. Despite problems with one of the retired Rate Sensor Units and the NICMOS valves, he and Smith met all their goals for the space walk.³²

A day later on 23 December, Foale and Nicollier replaced HST's late 1970s vintage DF-224 computer with the new and more powerful computer tested during the HOST mission. They then removed the balky Fine Guidance Sensor 2 and replaced it with the original FGS1 that had been returned to Earth in 1997, refurbished and renamed FGS2r. The third and final EVA on Christmas Eve got off to a difficult start when Grunsfeld's spacesuit developed a battery problem that required him to change into Foale's spacesuit converted to Grunsfeld's size. Then Grunsfeld and Smith installed the new solid state recorder in place of a reel-to-reel data recorder and a new S-band Single Access Transmitter. Since the transmitter was not designed to be replaced, the job required special tools.

The two astronauts wound up their work by installing new insulation materials on the two equipment bay doors. Using the robotic arm, Clervoy unberthed and released HST on Christmas Day. After the crew of STS-103 became the first Shuttle crew to mark that holiday on orbit, Discovery landed safely at Kennedy Space Center on the evening of 27 December, four days ahead of the dreaded Y2K bug.³³ Servicing Mission 3A stood out from the other servicing missions because it installed no new scientific instruments on board HST. Underlined by the fact that the failure of four gyroscopes meant NASA had suspended HST's science operations, STS-103 turned out to be a dramatic rescue mission that solved several urgent problems with Hubble's systems. Other major tasks remained for Servicing Mission 3B.

Hubble's new and repaired equipment checked out after the STS-103 crew returned home, and nearly a month later, NASA marked HST's return to normal operations with dramatic new images of planetary nebula NGC 2392 and a massive cluster of galaxies known as Abell 2218. Three months later in April, NASA celebrated ten years of Hubble operations. During that decade, HST made 271,000 individual observations of 13,670 objects and returned 3.5 terabytes of data, resulting in more than 2,651 astronomical papers. The U.S. Postal Service marked the anniversary with five commemorative stamps featuring HST images of celestial objects.³⁴

A NEW CAMERA AND NEW EQUIPMENT

On 28 September 2000, NASA named the first crew members for Servicing Mission 3B. To perform spacewalks during the STS-109 mission, then scheduled for late 2001, the agency named three veteran astronauts, including Grunsfeld as payload commander, James H. Newman and Richard M. Linnehan, along with first-time flyer Michael G. Massimino. The following March, the crew of STS-109 was filled out with commander Scott D. Altman, a two-time Shuttle veteran, first-time pilot Duane G. Carey, and arm operator Nancy J. Currie, who had extensive experience with the Shuttle robotic arm in her three previous flights. NASA charged the crew of the upcoming mission with installing the Advanced Camera for Surveys, fixing NICMOS, and replacing HST's solar arrays and its power control unit.³⁵

Scientists looked forward to the installation of the ACS in SM3B. Development of the instrument dated back to March 1992 when NASA Program Scientist Ed Weiler invited STScI to carry out a study with the astronomical community for an advanced camera to be installed during what was envisioned as the third full servicing mission in 1999. The study, which had support from the European Space Agency, led to a formal proposal in May 1993 for what became the ACS.

The proposal looked in depth at scientific priorities and technical issues around the instrument. With WFPC2 likely to be aging at that point, “an adequate optical and ultraviolet imaging capability will not be assured in 1999.” The proposal also assumed that an advanced camera would be able to exploit advances in detector and computer technologies during the 1990s.³⁶ When NASA issued an Announcement of Opportunity in 1993 for a new instrument, it received a proposal from a team led by Holland Ford of Johns Hopkins University, along with competing proposals from STScI, the Jet Propulsion Laboratory, and the Goddard Space Flight Center. In December 1994, NASA chose the proposal for an advanced camera led by Ford and his team.³⁷ ACS would take the place of the ESA’s FOC, the last original instrument on board the telescope. After having been used to obtain close-ups of all classes of astronomical objects from Pluto and its moons to stellar atmospheres and the cores of distant galaxies, FOC had been decommissioned in 1999 due to low demand.³⁸

Advanced Camera for Surveys (ACS)

Time on HST:
7 March 2002–present

Contractor:
Ball Aerospace

Principal Investigator:
Holland Ford
(Johns Hopkins University)

Weight: 397 kilograms
(875 pounds)

Axial Instrument

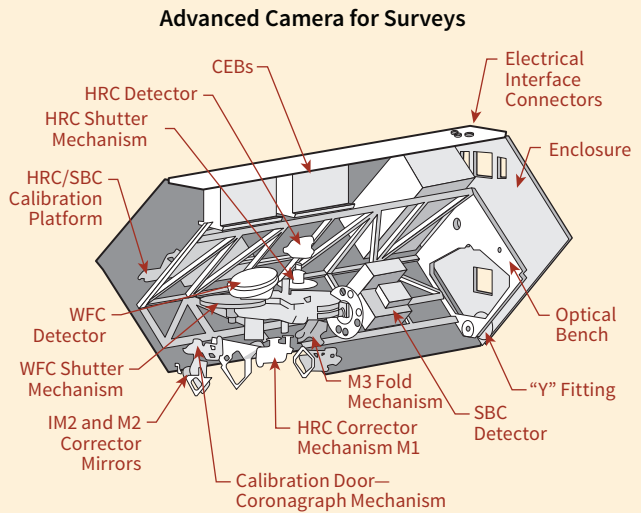

The Advanced Camera for Surveys is equipped with three channels: the Wide Field Channel operating in wavelengths from visible to near-ultraviolet wavelengths of 3,500 to 11,000 angstroms, the High Resolution Channel for near ultraviolet to near infrared wavelengths of 1,700 to 11,000 angstroms, and a Solar Blind Channel

The Advanced Camera for Surveys was equipped with three channels, including a wide field channel that could be used to survey the sky in search of galaxies and galaxy clusters. This channel had the capability to detect red light coming from red-shifted objects in distant parts of the universe. A high-resolution channel was designed to obtain detailed images of inner regions of galaxies and to take part in the search for exoplanets. The solar blind channel was sensitive to shorter wavelengths of light in the ultraviolet, but not to optical wavelengths where the Sun is brightest. The wide field and high-resolution channels each used a 4096 by 2048 pixel CCD operating in wavelengths from 1,700 angstroms in the ultraviolet to 11,000 angstroms in the near infrared. The Solar Blind Channel used a 1024 by 1025 pixel MAMA detector operating in the ultraviolet that had been a flight spare for the MAMAs used in STIS. The CCDs on ACS provided a five-fold improvement in sensitivity and covered twice as much area per exposure as WFPC2.³⁹

operating from 1,150 to 1,700 angstroms. In addition to imaging, the ACS is also capable of spectroscopy and polarimetry in all channels, and coronagraphy with the High Resolution Channel.

The Wide Field and High Resolution Channels use CCDs and the Solar Blind Channel uses a Far Ultraviolet Multi-Anode Microchannel Array (MAMA) detector, which was originally a flight spare for STIS. The Wide Field and High Resolution channels share two filter wheels and the Solar Blind Channel has its own filter wheel. The instrument's internal optics are adapted to compensate for HST's spherical aberration.

ACS experienced failures in its CCD electronics box and low voltage power supply in June 2006 and January 2007. Servicing Mission 4 astronauts installed new components in ACS in May 2009, which restored the Wide Field Channel but not the High Resolution Channel. The Solar Blind Channel was not affected by the electrical problems.^a

Because ACS has greater resolution and twice the field of view of WFPC2, it became HST's primary imaging instrument until WFPC2 was replaced in 2009 by WFC3. It has taken many memorable images of near and distant objects, including the "Hubble Ultra Deep Field" in 2003 and 2004.

^a Space Telescope Science Institute, *Advanced Camera for Surveys Instrument Handbook for Cycle 24, Version 15.0* (Baltimore, MD: STScI, January 2016).

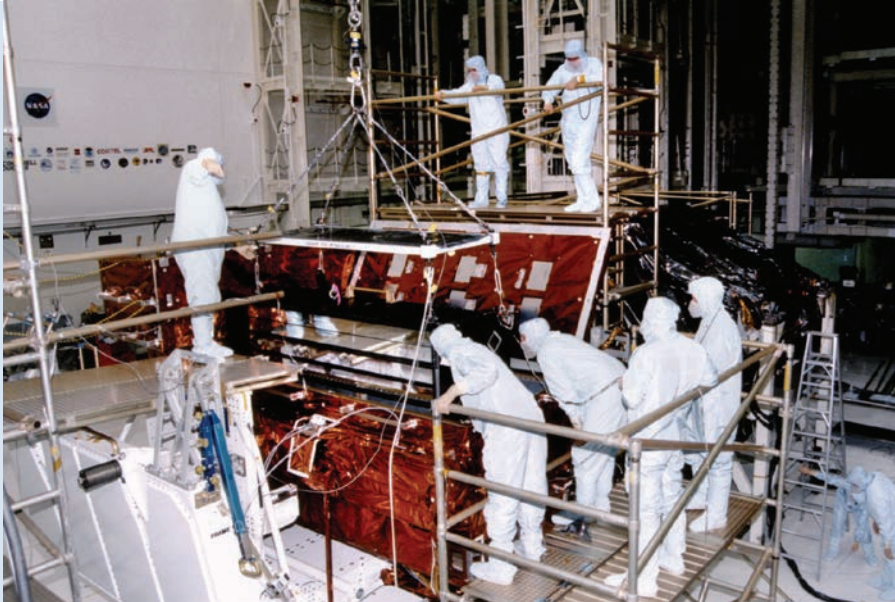

▲ Payload processing workers in Kennedy Space Center's Vertical Processing Facility (VPF) prepare to integrate the Space Telescope Imaging Spectrograph (STIS), suspended at center, into the Orbiter Replacement Unit (ORU) Carrier and Scientific Instrument Protective Enclosure (SIPE) for a flight on board STS-82 for installation on HST during Servicing Mission 2 in 1997. (NASA: 97e00003)

The STS-109 astronauts were also assigned to repair NICMOS, which had stopped operating prematurely on 3 January 1999 after nearly two years of operation when its supply of frozen nitrogen evaporated. Engineers and scientists at NASA Goddard in partnership with the contractor Creare Inc. devised the Reverse Brayton Cycle Cryocooler for NICMOS and tested it on HOST on STS-95. The new NICMOS Cooling System used neon gas in a closed loop and a compressor with a miniature turbine to cool NICMOS' detectors to minus 203 C or 70 K with minimal vibration, an important consideration on HST. Although the temperature was warmer than the minus 215 with the original cooler, the temperature was more constant. The STS-109 astronauts would install the new cooling system on NICMOS to restore its full function.⁴⁰

Another high priority for SM3B was installing HST's third set of solar arrays. The first two sets were silicon solar arrays made by British Aerospace as part of ESA's contributions to Hubble. These flexible arrays were designed to unroll during HST deployment, and NASA and ESA planned that they could roll up and be stowed during EVAs and when the Shuttle boosted HST into higher orbits. The original solar arrays caused the jitter that afflicted HST and led to



◀ On the Space Shuttle Columbia's middeck, the crew members of the March 2002 HST servicing mission, STS-109, pose for the traditional in-flight portrait. From left to right (front row) are Nancy J. Currie, mission specialist; Scott D. Altman, mission commander; and Duane G. Carey, pilot. From left to right (back row) are payload commander John M. Grunsfeld, Richard M. Linnehan, James H. Newman, and Michael J. Massimino, all mission specialists. (NASA: s109e6032)



◀ STS-109 crew insignia. (NASA)

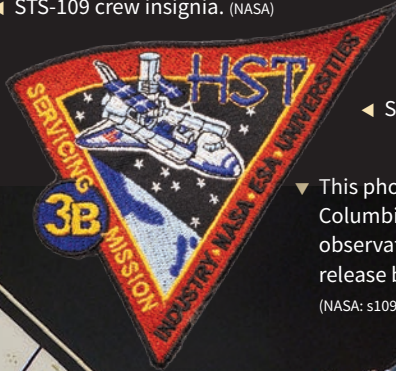

◀ SM3B insignia from GSFC. (NASA)

▼ This photo of HST was taken from Columbia as its robotic arm lifted the observatory from the cargo bay for its release back into orbit on 9 March 2002. (NASA: s109E5873)



their removal during SM1 in 1993, during which one of the arrays would not roll up. Although there was discussion of installing a different type of array during SM1, the second set was similar to the first, with changes to eliminate the jitter, but they quickly exhibited a twisting motion that caused continued concern about possible problems during servicing EVAs and reboost maneuvers during servicing missions. Despite these problems, the arrays had worked for eight years, well beyond their five-year design lifetime.⁴¹

NASA Goddard arranged for new rigid gallium arsenide solar arrays for HST that were one third smaller than the first two sets of silicon arrays but produced 20 percent more power. The new arrays used solar panels built in a Lockheed Martin production line for the fleet of first generation Iridium communications satellites. NASA Goddard personnel then attached the panels to lightweight aluminum-lithium wing structures they built for installation on HST. The new solar arrays' smaller area reduced drag, decreasing the rate at which HST's orbit would decay. ESA supplied new Solar Array Drive Mechanisms for the third set of arrays. The new solar arrays were due to be installed in tandem with a replacement for HST's Power Control Unit, which controls the telescope's electrical system. The unit needed to be replaced in anticipation of HST's extended lifetime on orbit. This job promised to be particularly challenging because the unit was not designed to be replaced, and the job would involve powering HST off for the first time since its launch. Indeed, the job might have been impossible without the work of the STS-31 spacewalkers Bruce McCandless and Kathryn Sullivan, who years before had worked with Lockheed and Marshall engineers to change how and where the unit was attached to the HST structure.⁴²

SERVICING MISSION 3B

For the first time, the original Shuttle to fly in space, Columbia, was used for a Hubble servicing mission. Coming off a lengthy refit, Columbia's scheduled launch on STS-109 slipped from late 2001 into the following year. NASA decided on a final major postponement to 28 February when problems appeared with a Reaction Wheel Assembly on HST, and astronauts needed time to train for the additional task of replacing the assembly. Following an additional one-day delay due to weather, Columbia and its crew lifted off from KSC Pad 39A in the predawn darkness at 6:22 a.m. EST on 1 March. Two days later, Currie grappled HST with the Shuttle's robotic arm and parked it on the Flight Support System in the payload bay. In preparation for their replacement, both solar arrays rolled up on command.⁴³

During the first EVA the next day, Grunsfeld and Linnehan removed the solar array on HST's starboard side and replaced it with a new array. The two

astronauts had to arrange tools and other aids at the start of the spacewalk, and this task and the complex work of removing the old solar array and its electronics and installing the new one took nearly seven hours. The astronauts had spent long hours training in the Neutral Buoyancy Laboratory and virtual reality simulators to prepare to move the large and heavy new panels, which in common with everything else, retain their mass properties such as momentum in the conditions of microgravity. Massimino, who with Newman repeated the replacement operation with the port solar array in the second EVA the next day, compared the job to moving a king-sized mattress. Massimino was holding the array while standing on a platform at the end of Columbia's robotic arm, and he considered the task of slowly rotating the array in the blackness of a night pass the toughest test he faced in the mission. "Inch by inch, I rotated the array until finally it was in the proper position. I felt the sweetest relief." The solar array replacement went well, and Massimino and Newman also replaced Hubble's troubled Reaction Wheel Assembly.⁴⁴

During the third spacewalk, controllers took the unprecedented action of powering HST down completely in preparation to replace HST's Power Control Unit. Mike Wenz of Lockheed Martin and other experts at the Space Telescope Operations Control Center at Goddard spent months preparing power down procedures and for restoring power to HST. The telescope's time without power had to be minimized because of the cold of space during much of each orbit. The controllers had already begun the lengthy procedure, which was known as "Super Proc," to power HST down when Grunsfeld announced from inside the Shuttle airlock that the life support unit in his spacesuit was leaking water and had to be exchanged for parts from another spacesuit before he and Linnehan could begin the spacewalk. The controllers halted the shutdown procedures and temporarily returned power to some equipment until the two astronauts were ready to pass through Columbia's airlock and begin their work. Despite the two-hour delay, HST was powered down for the first time in 12 years on orbit, and Grunsfeld and Linnehan undertook the difficult and intricate work of swapping the old and new power units with their 36 electrical connection points, using specially designed tools for the job. Many of the connectors were difficult to see, but equipped with special tools, the two astronauts were able to complete the work. The fact that Grunsfeld was left handed and could use both hands for such complicated work helped him with this difficult job. Soon the Goddard controllers restored power to HST and verified that the new power control unit was properly installed.⁴⁵

In EVA four, Newman and Massimino pulled the Faint Object Camera out of Hubble's axial bay for stowage on the Shuttle and then installed ACS in



▲ The Hubble Space Telescope (HST) returns to its normal observing routine after a week of servicing and upgrading by the STS-109 astronaut crew aboard the Space Shuttle Columbia in March 2002. Following that mission, HST was equipped with its third set of solar arrays, which are smaller than the first two sets. (NASA: STS109-331-010)

its place. The two astronauts also began the work of installing an electronics module for the new NICMOS cryocooler, which, Linnehan and Grunsfeld installed the next day during the fifth EVA of the mission. During that spacewalk, the two astronauts installed the new Cryocooler on NICMOS and added a radiator for the new unit on the exterior of HST's aft shroud, which was a difficult job due to misaligned latches. They completed the job by making electrical and plumbing connections between the cryocooler and radiator. With the repairs completed and verified, HST was released and Columbia and her crew returned to Earth after nearly 12 days in space.⁴⁶ In an online commentary on STS-109's final spacewalk, Grunsfeld said, "I gave Hubble a final small tap goodbye, and wished it well on its journey of discovery. It is likely I will never see the Hubble Space Telescope again, but I have been touched by its magic and changed forever."⁴⁷ Having made two visits to HST, Grunsfeld was moving on to management work after STS-109. He did not know then that the surprising turns taken by HST through its existence—and his personal contact with Hubble—were far from over.

When Columbia landed at Kennedy Space Center at the end of SM3B, HST managers were already making preparations for the fifth servicing mission. WFPC2 was getting old and NASA was building another new camera for Hubble. With all the other instruments on HST equipped with their own corrective optics, COSTAR was no longer needed, and NASA, the University of Colorado, and Ball Aerospace experts were building a new instrument, the Cosmic Origins Spectrograph (COS), to take its place.

A NEW OBSERVATORY

After four servicing missions, HST concluded its twelfth year on orbit with a full suite of scientific instruments that were not there when it was launched. SM3B installed a new instrument, ACS, and restored NICMOS to good health. ACS has produced many important HST images in the years since its installation, including major contributions to the Hubble Ultra Deep Field, but it suffered an electrical short in 2007 that required repairs. The new cooling system in NICMOS worked as hoped, and NICMOS provided HST with important capabilities in the infrared until it failed in 2008. The instrument operated for eight years with both coolers, far longer than the four and a half years originally planned, allowing scientists to use the instrument for a wide range of observations.

HST Senior Project Scientist David Leckrone gave two Goddard experts credit for the successful NICMOS restoration with the new cryocooler. One was Ed Cheng, a physicist and engineer who played a major role in creating the new cryocooler when it was needed. Another was Frank Cepollina, who convinced NICMOS designers years before to add valves to NICMOS' internal coolant lines in case someone wanted to restore NICMOS' cooling function. The valves made possible the replacement of the cooling system.⁴⁸ Cepollina and his group at Goddard made the three servicing missions outlined in this chapter possible, especially tasks that hadn't been anticipated when HST was built, such as the NICMOS cryocooler and replacing the Power Control Unit in SM3B. The roles of both Cheng and Cepollina in HST were far from over when STS-109 completed its work on Hubble.

Hubble's first four servicing missions took place while Daniel S. Goldin served as NASA Administrator from 1992 to 2001. While he was associated with the concept of "faster, better, cheaper" spacecraft, Goldin pointed out in an interview that the laws of physics sometimes demand that the spacecraft be bigger, such as Hubble or the James Webb Space Telescope. In a study of low-cost innovation at NASA during that time, Howard E. McCurdy wrote that the "faster, better, cheaper" approach was used for the Spitzer Space Telescope, the

▼ HST spectroscopy instruments

	Faint Object Spectrograph	Goddard High Resolution Spectrograph	Space Telescope Imaging Spectrograph	Near Infrared Camera and Multi-Imaging Spectrometer	Cosmic Origins Spectrograph
Launch	1990	1990	1997	1997	2009
Return	1997	1997			
Placement	Axial	Axial	Axial	Axial	Axial
Detectors	2 digicon detectors	2 digicon detectors	1 CCD 2 MAMA*	3 HgCdTe detector arrays	1 photon counting detector 1 MAMA
Wavelengths	1,150–8,500 angstroms	1,150–3,200 angstroms	1,150–10,300 angstroms	8,000–25,000 angstroms	1,150–3,000 angstroms
Capabilities	Used for observations of distant and faint objects	Used for spectroscopy in the ultraviolet	Used for both spectroscopy and imaging	Greatest sensitivity on HST in the infrared	Designed to complement the capabilities of STIS

▼ HST imaging instruments

	Wide Field/ Planetary Camera	Wide Field Planetary Camera 2	Wide Field Camera 3	Faint Object Camera	Advanced Camera for Surveys
Launch	1990	1993	2009	1990	2002
Return	1993	2009		2002	
Placement	Radial	Radial	Radial	Axial	Axial
Detectors	8 CCDs	4 CCDs	2 CCDs 1 IR detector	2 photon counters	3 CCDs 1 MAMA
Wavelengths	1,150–11,000 angstroms	1,150–10,500 angstroms	2,000–17,000 angstroms	1,200–7,000 angstroms	1,700–11,000 angstroms
Capabilities	Wide field and narrower angle cameras	1 CCD higher resolution	Wider capability in UV and IR	Used HST's full resolution capabilities	Also capable of spectroscopy and polarimetry

* Multi-Anode Microchannel Array detector

infrared Great Observatory that was launched in 2003 after the mission was redesigned and the spacecraft shrunk.⁴⁹

With its new instruments, HST was far more capable than it was when it was first launched in 1990 and even more than it was after the 1993 repairs that overcame the flaw in its main mirror. In the words of Ken Sembach, STScI's director starting in 2015, most people think of Hubble as a single observatory.

serviced. It's a new observatory every time it's been visited by humans."⁵⁰ The work and results of the servicing missions set HST apart from other space telescopes and other robotic spacecraft, but so was the scientific bounty of HST that was vastly enhanced by the work of the astronauts and the experts who backed them up.

ENDNOTES

- 1 John K. Davies, *Satellite Astronomy: The Principles and Practice of Astronomy from Space* (Chichester: Ellis Horwood Ltd., 1988), pp. 94–117.
- 2 Davies, *Satellite Astronomy*, pp. 143–156; Edwin F. Erickson and Allan W. Meyer, *NASA's Kuiper Airborne Observatory, 1971–1995: An Operations Retrospective With a View to SOFIA* (Moffett Field, CA: NASA Ames Research Center, 2013).
- 3 David Leckrone, oral history interview by author, 6 November 2015, part 2, pp. 3–4.
- 4 NASA, "Announcement of Opportunity: Hubble Space Telescope," 15 October 1984, OSSA-4-84, in Hubble Space Telescope Collection, Series 8, Box 1.1, file "Announcement of Opportunity, 1984," JHU Library Special Collections.
- 5 E. J. Weiler, "Hubble Space Telescope Second Generation Instrument Selection," *Highlights of Astronomy, Vol. 8: As Presented at the XXth General Assembly of the International Astronomical Union, 1988*, (Dordrecht: Kluwer Academic, 1989), pp. 441–442.
- 6 Leckrone OHI, *Ibid.*; John Hutchings, oral history interview by author, 30 March 2015, p. 12; Ted Gull, oral history interview by author, 12 May 2015, pp. 8–9; J. Gethyn Timothy, "Review of Multianode Microchannel Array Detector Systems," *Journal of Astronomical Telescopes, Instruments, and Systems* 2(3), 030901 (July–September 2016).
- 7 Timothy, "Review of MAMA Systems," p. 6; Ed Weiler, personal communication with author, 18 April 2017. Weiler added that most Shuttle manifests were subject to change until launch was imminent.
- 8 *NASA Fact Sheet: HST Servicing Mission: Cost to Taxpayers*, (Washington, DC: NASA Headquarters, August 1993); Timothy, "Review of MAMA systems," p. 6; Leckrone OHI, pp. 5–6; Weiler, e-mail to author, 18 April 2017. See also STScI, "Report of the HST Science Instrument Replacement Strategy Review, March 7, 1991," STScI archive, Box 4.5, file "Attachment 1: Report of the HST Science Instrument Replacement Strategy Review," JHU Library Special Collections. Brown and Ford, *A Strategy for Recovery*, p. 118, had WFPC2 flying in 1993, NICMOS in 1996, and STIS in 1999, but noted that this schedule was then (early 1991) "under review."
- 9 "Minutes of the Hubble Space Telescope Servicing Science Working Group, 15 February 1995," Greenbelt, MD: NASA Goddard Space Flight Center, STScI Archive, Box 1.14, file "Minutes of the HST Servicing Science Working Group, 15 Feb 1995," "Statement of HST Users Committee Concerning Development of COSTAR and the Advanced Scientific

- Instruments of HST,” February 1991, Box 1.4, file “STIC, 11–12 Feb 1991,” JHU Library Special Collections.
- 10 NASA, “STS-82 Press Kit”; Timothy, “Review of MAMA systems.”
 - 11 NASA, “STS-82 Press Kit”; AURA, “Independent Science Review: NICMOS Cryocooler, September 10, 1997” STScI Archive, Box 1.10, file “American Astronomical Society (AAS), 1994–1999,” JHU Library Special Collections.
 - 12 NASA, “Space Shuttle Mission STS-82 Press Kit,” February 1997.
 - 13 STScI, *Fine Guidance Sensor Instrument Handbook for Cycle 24, Version 23*, (Baltimore, MD: STScI, January 2016), p. 9. In 1989, Perkin-Elmer became known as Hughes Danbury Optical Systems after it was sold to Hughes Aircraft. Raytheon purchased the firm in 1997 and sold it in 2002 to the Goodrich Corporation. It has been owned since 2012 by United Technologies Corporation.
 - 14 NASA, “STS-82 Press Kit,” p. 18–21.
 - 15 Joseph R. Tanner, oral history interview by author, 9 September 2015, pp. 4–5; Steven A. Hawley interviewed by Sandra Johnson, NASA Johnson Space Center Oral History Project, 14 January 2003, pp. 6–7; Sheffield OHI, part 1, pp. 5–6.
 - 16 Stephen A. Hawley, “Foreword,” from David J. Shayler and David M. Harland, *Enhancing Hubble’s Vision: Service Missions That Expanded Our View of the Universe* (Chichester: Springer Praxis, 2016), p. xiii.
 - 17 Hawley, “Foreword”; Hawley, “HST Solar Array Concerns,” p. 20.
 - 18 Tanner OHI, pp. 9–16; NASA, “STS-82 Press Kit”; Johnson Space Center, STS-82 Mission Status Reports #9–#11, 15–16 February 1997; Hawley, “HST Solar Array Concerns,” pp. 20–22.
 - 19 Tanner OHI, pp. 19–21; Johnson Space Center, STS-82 Mission Status Report #11, 16 February 1997.
 - 20 Tanner OHI, pp. 15–16, 19–21; Johnson Space Center, STS-82 Mission Status Report #13, 17 February 1997. NASA JSC photo 82320029 is available at <https://spaceflight.nasa.gov/gallery/images/shuttle/sts-82/html/82320029.html>.
 - 21 Tanner OHI, pp. 14–15.
 - 22 STScI, “The 20th Anniversary of the Hubble Space Telescope’s STIS Instrument,” news release STScI-2017-06, 28 February 2017; STScI, *Space Telescope Imaging Spectrograph Instrument Handbook for Cycle 24, Version 15.0* (Baltimore, MD: STScI, January 2016), p. 13.
 - 23 STScI website, “Hubble Space Telescope NICMOS History,” <http://www.stsci.edu/hst/nicmos/design/history> (accessed 19 April 2017); AURA, “Independent Science Review: NICMOS Cryocooler.”
 - 24 NASA, “A Mission of Discovery: Space Shuttle Mission STS-95 Space Shuttle Press Kit,” October 1998; Ann Jenkins, “HOST Mission Accomplished!” *Hubble Space Telescope Newsletter*, Goddard Space Flight Center, 12, no. 9 (December 1998): 1–5; “Training Begins for Next Hubble Servicing Mission,” *Goddard News* 2 no. 31 (August 1998): 1; NASA, “Refining the Hubble Space Telescope’s View of the Universe,” Larry Dunham, e-mail to author, 13 February 2018; STS-103 “Space Shuttle Press Kit,” November 1999.

- The crew of STS-95 was made up of Curtis L. Brown, Jr., commander; Steven W. Lindsay, pilot; and mission specialists Stephen K. Robinson, Scott E. Parazynski, Pedro Duque of the European Space Agency, Chiaki Mukai of the Japanese Space Agency, and Senator John H. Glenn. The mission ended on 7 November 1998 after nearly nine days in space.
- 25 “Training Begins for Next Hubble Servicing Mission,” *Goddard News* (August 1998); NASA News, “Training Begins for Crew of Next Hubble Space Telescope Mission,” release 98-138, NASA Headquarters, 30 July 1998.
 - 26 NASA, “STS-103 Press Kit.”
 - 27 NASA News, “NASA Plans Early Servicing Mission to Hubble Space Telescope,” release 99-38, NASA Headquarters, 10 March 1999.
 - 28 Dennis R. Jenkins, *Space Shuttle: Developing an Icon, 1972–2013, Volume III—The Flight Campaign* (South Forest Lake, MN: Specialty Press Inc., 2016), p. 339. The concept was modified after the Columbia accident in 2003, as will be discussed in chapter seven.
 - 29 NASA News, “Shuttle Veterans Complete Hubble Servicing Crew,” release 99-41, NASA Headquarters, 12 March 1999.
 - 30 Scott Kelly and Margaret Lazarus Dean, *Endurance: A Year in Space, A Lifetime of Discovery* (New York: Alfred A. Knopf, 2017), p. 217; NASA News, “Hubble Telescope Placed Into Safe Hold as Gyroscope Fails,” release 99-136, NASA Headquarters, 15 November 1999; Robin Suriano, “Hubble’s Wait Almost Over,” *Florida Today* (20 December 1999): 1. To get a taste of the widespread nature of the concerns about the Y2K computer problem, see William J. Clinton, “Statement on Signing the Year 2000 Information and Readiness Disclosure Act,” 19 October 1998, online at the American Presidency Project, <http://www.presidency.ucsb.edu/ws/index.php?pid=55108> (accessed, 5 May 2017).
 - 31 Kelly, *Endurance*, pp. 216–221; Suriano, “Hubble’s Wait Almost Over”; Lockheed Martin Missiles and Space, *Hubble Space Telescope Servicing Mission 3A Media Reference Guide* (1999). The cancelled fourth EVA would have involved installation of insulation materials and protective covers on HST.
 - 32 John Grunsfeld, *Notes from Space: One Incredible Day, Dispatch #7 (Thursday December 23)*, NASA Human Spaceflight website <http://spaceflight.nasa.gov/shuttle/archives/sts-103/crew/grunsfeldreports/gr7.html> (accessed 31 March 2016).
 - 33 Grunsfeld, *Notes from Space*; STS-103 Mission Control Center Status Reports; NASA, “STS-103 Press Kit.” STS-103 was the last of only three Shuttle missions in 1999.
 - 34 NASA News, “Hubble Reopens Eye on the Universe,” NASA Headquarters, release 00-16, 24 January 2000; “April 24 Marks a Triumphant Ten Years in Space for Hubble Telescope,” NASA Headquarters, release 00-59, 11 April 2000; “NASA, U.S. Postal Service Celebrate Hubble Space Telescope 10th Anniversary with Stamp Unveiling and Other Events,” NASA Headquarters, release N00-14, 4 April 2000.
 - 35 NASA News, “Astronauts and Cosmonaut Named to Four Shuttle Missions in 2001,” NASA Headquarters, release 00-154, 28 September 2000; “Final Crew Members Named to Hubble Overhaul Mission,” NASA Headquarters, release 01-54, 26 March 2001.
 - 36 Robert A. Brown, *The Future of Space Imaging: Report of a Community-Based Study of an Advanced Camera for the Hubble Space Telescope* (Baltimore: Space Telescope Science

- Institute, 1993), p. viii. See also Holland Ford, oral history interview by author, 27 October 2015, pp. 15–18; Leckrone OHI, part 2, 14; Robert Brown, oral history interview by author, 14 December 2016, pp. 8–9.
- 37 Ed Weiler, personal communication with author, 3 May 2017; M. Clampin et al., “The Advanced Camera for Surveys,” from P. Benvenuti, F. D. Macchetto, and E. J. Schreier, eds., *Science with the Hubble Space Telescope—II* (Baltimore, MD: STScI, 1996); letter from Wesley T. Huntress, Jr., NASA Associate Administrator for Space Science, to Holland Ford, JHU, 21 December 1994; News Release, “Hopkins, Space Telescope Scientists Design Advanced Hubble Camera,” *Headlines@Hopkins*, Johns Hopkins University, 30 December 1994.
 - 38 STScI, “Space Telescope Users Committee Minutes of November 1997 Meeting,” 24 November 1997. For more on FOC’s time on HST, see Andrew Wilson, *ESA Achievements: More than 30 Years of Pioneering SpaceActivity, 3rd Edition* (Noordwijk: European Space Agency, 2005), pp. 128–133; and ESA News Release, “European Faint Object Camera on Hubble Sets World Record—Celebrating the Successes of ESA’s Sharp-Sighted Camera,” HEIC0204, 7 March 2002.
 - 39 NASA, “Rejuvenating the World’s Greatest Observatory, STS-109 Press Kit,” February 2001; STScI, *Advanced Camera for Surveys Instrument Handbook for Cycle 24, Version 15.0* (Baltimore, MD: STScI, January 2016); Timothy, “Review of MAMA systems,” p. 17.
 - 40 NASA, “STS-109 Press Kit,” pp. 34–35; STScI, *Near Infrared Camera and Multi-Object Spectrometer Instrument Handbook for Cycle 17, Version 11.0* (Baltimore, MD: STScI, June 2009), p. 7; STScI, Hubble Space Telescope NICMOS History, <http://www.stsci.edu/hst/nicmos/design/history> (accessed 15 October 2017).
 - 41 Wood notebooks, “Record IV,” 1 July 1991; Hawley, “HST Solar Array Concerns,” pp. 16–23.
 - 42 NASA, “STS-109 Press Kit,” 32, 33, 36–38; Hawley, “HST Solar Array Concerns,” p. 23; ESA, “How Hubble Got Its Wings: 6. Hubble’s Second-Generation Arrays.” The second set of arrays were each 39.67 by 9.75 feet, weighed 339 lbs., and generated 4600 Watts after six years on orbit. The third set is 24.75 by eight feet, weighs 640 lbs., and was due to generate 5270 W after six years on orbit. See Sullivan, *Handprints on Hubble*, pp. 142–149, on the Power Control Unit.
 - 43 Shayler and Harland, *Expanding Hubble’s Vision*, pp. 105–107; Mike Massimino, *Spaceman: An Astronaut’s Unlikely Journey to Unlock the Secrets of the Universe* (New York: Crown Archetype, 2016), pp. ix–xiv, 174–181. Massimino flew on two HST servicing missions and his book provides a candid view of his own career and the work done by astronauts on Hubble servicing missions.
 - 44 Massimino, *Spaceman*, pp. 154–168, 181–198, quote 195; NASA, “STS-109 Press Kit,” pp. 43–48.
 - 45 John Grunsfeld, *Notes from Space: STS-109 Report #4*, NASA Human Spaceflight website, http://www.nasa.gov/mission_pages/shuttle/shuttlemissions/list_2002.html (accessed 27 April 2017); NASA Goddard, “Hubble’s Memorable Moments: Powering Down,” YouTube, <https://www.youtube.com/watch?v=2yCvxEN9NI4> (accessed 27 April 2017); NASA, “STS-109 Press Kit,” pp. 48–51; Grunsfeld e-mail to author, 29 October 2017.

- 46 NASA, "STS-109 Press Kit," pp. 49–52; John Grunsfeld, *Notes from Space: STS-109 Report #5*; Massimino, *Spaceman*, pp. 200–207; NASA Human Spaceflight, STS-109 Mission Archives http://www.nasa.gov/mission_pages/shuttle/shuttlemissions/archives/sts-109.html (accessed 1 April 2016).
- 47 John Grunsfeld, *Notes from Space: STS-109 Report #6*.
- 48 David Leckrone OHI, 6 November 2015, part 2, pp. 8–9; NASA News Release, "Astronomers Find Elusive Planets in Decade-Old Hubble Data," release 2011-315, 6 October 2011.
- 49 Goldin OHI, p. 10; Howard E. McCurdy, *Faster Better Cheaper: Low-Cost Innovation in the U.S. Space Program* (Baltimore, MD: The Johns Hopkins University Press, 2001), pp. 142–144.
- 50 Ken Sembach, oral history interview by author, 25 May 2017, p. 15.



CHAPTER SIX

The Universe Turned Inside Out

▲ Hubble view of NGC 5033, located about 40 million light-years away in the constellation of Canes Venatici. (ESA/Hubble/NASA. Acknowledgment: Judy Schmidt: potw1843a)

Through its images, the Hubble Space Telescope brought astronomical discovery to the masses. But Hubble was created to advance astrophysics as the first optical imaging telescope located outside Earth's atmosphere. After three decades of HST operations, the universe looked very different to scientists than it did in the 1980s. "I think it's fair to say that Hubble's actually rewritten all the textbooks," said Ken Carpenter, a NASA astrophysicist who has worked with HST throughout his career. "I don't think you can pick up a textbook nowadays where a page hasn't been changed because of one Hubble observation or another." But the story of astrophysics in the lifetime of HST is far bigger than HST. More astronomers are working than ever, using bigger and more advanced instruments both on the ground and in space that observe in wavelengths ranging from gamma rays through to radio waves, with HST observing only a small range of wavelengths in the middle. In Carpenter's words, Hubble has operated "in an era where we've gone to more multi-wavelength astrophysics."¹

By the time HST reached its 25th anniversary on orbit in 2015, it had circled Earth more than 130,000 times and made more than a million exposures of astronomical objects with its instruments. HST established itself as arguably the most productive scientific instrument ever built, with scientists writing more than 12,800 scientific articles using HST data during that quarter century, papers that had been cited more than 550,000 times. Observing time on HST was available to anyone willing to write a proposal for its use who could pass a peer review process involving competition with astronomers from around

the world. The Space Telescope Science Institute allocated observing time in those 25 years in 22 observing cycles, during which more than 4,600 observing proposals were given time on HST, ranging from short “snapshots” of one orbit to treasury programs gathering massive amounts of data over hundreds of orbits. The archive of HST observations, open to all, has become an important resource for science. Eventually, more papers came from the archive than new observations; in 2015 for example, 327 papers relied on new HST observations, compared to 356 papers that used archival data, and 156 that relied on both new and archival data.²

Throughout history, the heavens have surprised astronomers when they first used new ways to observe it, most famously in the case of Galileo and his telescope. “The universe is wilder than we imagine: we keep underestimating how weird it really is,” Harvard astrophysicist Robert Kirshner wrote. “Astronomy is a science driven by discovery, since the objects we observe are stranger and more exotic than even the most unbridled speculators predict.”³ Even before HST was launched, astronomers anticipated pointing its cameras and spectrographs at a whole variety of targets, including planets, stars of varying kinds and points in their lives, quasars, black holes, star clusters, galaxies, and nebulae of many types, to name just a few. Today we know more about all of these objects, thanks to a large degree to HST. The large number of scientific papers based on HST data illustrates the variety of topics covered by the astronomers and physicists using it.

THE TOP PRIORITY

HST’s scientific discoveries are so numerous and broad that only a few highlights can be discussed in this chapter. To better understand what Hubble has discovered, this account of HST’s scientific work begins with its early scientific plans and goals. As HST’s launch approached, scientists in the Space Telescope Advisory Council designated three “Key Projects” for the space telescope: determination of the distance scale of the universe to within an accuracy of 10 percent; studying spectra of quasars to not only find out more about these bodies but also about the matter that lay between them and Earth; and obtaining lengthy exposures of apparently empty parts of the sky, to see if they contained any unexpected phenomena. Beyond those three projects, astronomers had a long list of objects they wanted to study with HST, ranging from the planet Mars to the most distant galaxies and the matter in between.⁴

The priority given to the first Key Project showed that scientists’ major hope for HST was that it would help them measure the size of the universe. For decades astronomers had worked to accurately measure the distances between

stars and between galaxies. Astronomers had devised many methods of measuring those distances, but the accuracy of all those methods was open to question before Hubble flew. More accurately measuring distances in the universe would, in turn, help answer many questions, notably the age of the universe. Astronomers had known since the 1920s that distant galaxies are moving away from one another, evidence that the universe is expanding, but they didn't know precisely how fast those galaxies were moving. Many astronomers believed that the rate of that expansion was slowing down, but the question was still open in 1990 when HST was launched.⁵ To understand HST's work on this problem, we will look back nearly a century before its launch and some history where HST's namesake Edwin Powell Hubble plays a prominent role.

For much of the 19th century and into the early years of the 20th century, the most popular astronomical theory doubted that there were galaxies beyond our own galaxy. Some astronomers disagreed with this view, suggesting that what were then known as spiral nebulae were not small bodies inside the Milky Way but rather island universes or galaxies of their own. Astronomers could not measure the size of our own galaxy, let alone the distances to prominent objects like the great spiral nebula in Andromeda, because stars come in various sizes and types that affect how much and what kind of light they give off. If the absolute brightness of an object is not known, it is highly difficult to deduce its distance without another piece of evidence. In

1908, Henrietta Swan Leavitt of the Harvard College Observatory made a breakthrough in measuring distances in the universe while observing a type of star called Cepheids, or Cepheid variables, whose light varies over time. By observing a number of Cepheids about 200,000 light-years away in the Small Magellanic Cloud whose distances from Earth were

roughly the same, she discovered a relationship between the period of light variation and the absolute amount of light given off by individual Cepheids. Astronomers were able to make rough estimates of the distance of Cepheids nearby in our own galaxy, and together with Leavitt's finding of the relationship between their brightness and period, the door was open to using Cepheids as a "standard candle" for measuring distances around the universe. Other astronomers advanced Leavitt's work on Cepheid variables and found other evidence supporting the idea that spiral nebulae were in fact separate from our Milky



▲ Henrietta Swan Leavitt. (American Institute of Physics, Emilio Segrè Visual Archives via Wikimedia)



▲ Edwin P. Hubble in 1931. (Johan Hagemeyer via Wikimedia)

Way galaxy. But the argument over the nature of the universe continued into the 1920s.

The gigantic 100-inch (2.54-meter) Hooker telescope on Mount Wilson in California opened in 1919, and among the staff was the 30-year-old Hubble, fresh from his war-time service. In October 1923, Hubble exposed a photographic plate of the Andromeda Nebula that showed what he determined to be a Cepheid variable star in that body. By comparing this image to other photographic plates of the nebula, Hubble was able to verify the period of the Cepheid variable and use that information to estimate the Andromeda Nebula's distance from Earth at about 900,000 light-years—placing

it well outside the Milky Way. Hubble's observations confirmed the growing consensus in favor of island universes, which vastly expanded the bounds of the universe and showed that the Andromeda Nebula was in fact a galaxy of its own.⁶

Observations by Vesto M. Slipher and other astronomers showed that galaxies were moving at high speed, and over time they saw that most galaxies were moving away from the Milky Way. Much like the Doppler effect produced in sound when a train or an aircraft passes near a listener, astronomers see that light shifts to the red end of the spectrum when an object is moving away, a redshift, and toward the blue end of the spectrum when an object is approaching. In 1929, Hubble, with help from his collaborator Milton L. Humason, built on Slipher's work with redshifts, refined the distances of 24 galaxies, and noted a relationship between the redshifts and their distances. Hubble's resulting paper showed that velocities of these galaxies equaled their distance multiplied by a constant. Hubble and Humason followed this up with another paper in 1931 that showed this relationship extending to more distant galaxies. Starting

with the Belgian priest and astronomer Georges Lemaître, astronomers and physicists came to accept that there was a firm relationship between galaxies' distances from us and their redshifts—that the farther a galaxy is from us, the faster it is moving. Over time, the insight of the expanding universe was credited to Hubble, and the terms Hubble's law and the Hubble constant came into use in the 1950s. (In 2018, members of the International Astronomical Union voted to use the term Hubble-Lemaître law.)⁷

Early estimates of the Hubble constant were problematic because they set the age of the universe at less than the age of Earth as determined by radioactive decay methods. Those early measurements of the distance of objects like the Andromeda galaxy were still highly approximate. By improving their knowledge of Cepheids and taking greater account of gas and dust that could affect distance measurements, Hubble's assistant and heir Allan Sandage and other astronomers used Mount Wilson and the 200-inch (5-meter) Mount Palomar telescope to revise their distance and time estimates upward. In the years that followed, governments and universities built new optical telescopes at sites with superior viewing conditions such as Mauna Kea in Hawaii and the Chilean Andes, their capabilities enhanced by new technologies. These observatories were complemented by radio telescopes and the first generation of space-based telescopes in the 1960s through the 1980s observing in a variety of wavelengths, such as the Orbiting Astronomical Observatory in the ultraviolet, Cos-B for gamma rays, Uhuru for x-ray astronomy, the High Energy Astronomy Observatory program, and the Infrared Astronomy Satellite. Astronomers and physicists learned a great deal about the universe, but many gaps remained in this body of knowledge that scientists hoped HST could fill. Before HST was launched, estimates for the Hubble constant varied between 50 and 100 kilometers per second per megaparsec, and the age of the universe between 10 and 20 billion years. Because of its great power and location outside Earth's atmosphere, HST would be able to make precise observations of galaxies and stars, reducing the uncertainties surrounding the Hubble constant and thus the inferred size and age of the universe.

The HST Key Project on the Extragalactic Distance Scale, headed by co-Principal Investigators Wendy L. Freedman of the Carnegie Observatories, Robert C. Kennicutt, Jr. of the Steward Observatory at the University of Arizona, and Jeremy Mould of the Australian National Observatory, began measuring distances of nearby galaxies even before HST's spherical aberration was corrected. They started with M81, whose distance was estimated in 1993 at 11 million light-years with an uncertainty of 10 percent using WF/PC observations of Cepheid variables.⁸ When more observations were made after HST's

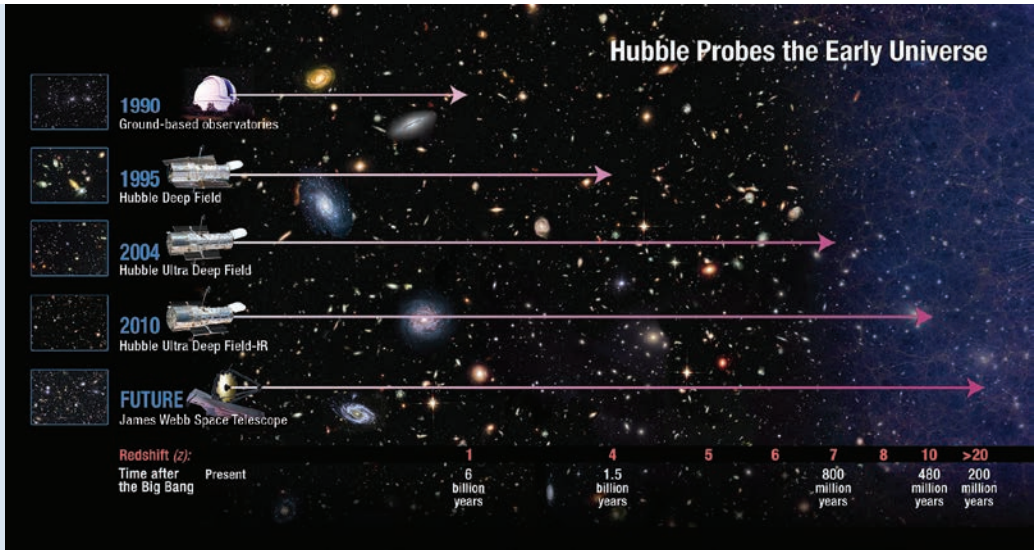

▲ This diagram shows how HST has revolutionized the study of the distant, early universe. Before Hubble was launched, ground-based telescopes were able to observe up to a redshift of around 1, about halfway back through cosmic history. Hubble's latest instrument, Wide Field Camera 3 has identified a candidate galaxy at a redshift of 10—around 96 percent of the way back to the Big Bang. (NASA/ESA)

spherical aberration was corrected, the Key Project came up with a puzzling estimated value for the Hubble constant, which suggested that the universe was younger than its oldest stars. In the later 1990s, further announcements followed from the Key Project and other investigators about new measurements of more distant galaxies using HST. The Key Project used HST to look at Cepheids in 18 galaxies up to 65 million light-years distant, which was much farther than M81 but still relatively close to Earth. As the Key Project wound up its work in 1999, it announced a Hubble constant estimate of 70 kilometers per second per megaparsec, with an uncertainty of 10 percent. With this figure and other information, the age of the universe was estimated at 12 billion years.⁹ The Key Project's work to determine the Hubble constant and the age of the universe was only the beginning of HST's contributions to answering these questions.

SEEKING OUT SUPERNOVAE

Unfortunately, Cepheid variables are only useful as a distance indicator for nearby galaxies such as Andromeda and the galaxies examined as part of the Key Project. Over the years, astronomers developed a “cosmic distance ladder” of different ways to measure distances to galaxies farther out. The ladder starts at the bottom with Cepheid variables, and a popular method to measure far

greater distances is based on observations of a type of supernova, a stellar explosion bright enough to be seen even in distant reaches of the universe. In the 1930s and early 1940s, Fritz Zwicky, Walter Baade, and Rudolph Minkowski showed that a specific type of supernova called type Ia could be used as a “standard candle” measurement for galactic distances. This type of supernova results when a white dwarf star orbiting another star accretes matter from that star and becomes unstable. Supernovae of this type are believed to be rare, however, and their brightness lasts only hours or days. But once these supernovae are identified by their spectral signatures, astronomers can deduce their distance from their apparent brightness. In the words of astronomer Laura Ferrarese: “Type Ia supernovae are the Ferrari of distance indicators: rare, expensive, finicky, but hard to beat when it comes to performance.”¹⁰ In 1985, teams of astronomers began searching for type Ia supernovae, mainly using ground-based telescopes, with the hope of determining the distances of more distant galaxies, and thus getting a better fix on the size, age, and expansion rate of the universe. The Supernova Cosmology Project (SCP) headed by Saul Perlmutter of the Lawrence Berkeley National Laboratory in California began its search in 1985 and another group, the High-z Supernova Search Team, joined the search in 1994. The High-z group, whose name comes from astronomical shorthand for redshift, was headed by Brian Schmidt of the Mount Stromlo Observatory in



▲ Saul Perlmutter. (Roy Kaltschmidt, Lawrence Berkeley National Laboratory)



▲ Brian P. Schmidt in 2012. (Markus Pössel via Wikimedia)

Australia and Nicholas Suntzeff of the Cerro Tololo Inter-American Observatory in Chile with the support of Kirshner, who had trained many of the group's members. Both teams worked to find supernovae in distant galaxies near their maximum luminosities and then verify their types with spectrographic observations, mainly using ground-based facilities.¹¹ The two teams then sought to determine the distances of the supernovae by observing their light curves after the explosions that created the supernovae. The rivalry between the two teams was illustrated when SCP team members believed that the High-z team was using methods they had developed. One observer wrote, "The tensions between the two teams were personal and emotional, but more importantly, they were philosophical: do you want fewer observations done more carefully or more observations done less carefully?"¹²

Because HST's instruments have very narrow fields of view, they were not used to search for supernovae. HST was used instead for follow-up observations of supernovae in distant galaxies, where HST's power and resolution allowed users to differentiate between the light emitted by supernovae and the galaxies they were located in. Despite the attractions of using HST for these observations, most could still be done from the ground, and the HST Time Allocation Committee rejected an initial application for HST observation time from Perlmutter's team. Kirshner, for his part, believed that HST did not need to be used to observe supernovae light curves because this could be done from the ground—though other members of the High-z team disagreed with him. In January 1996, Perlmutter asked STScI director Robert Williams for director's discretionary time, and after consideration, Williams offered both teams time on HST.¹³ Williams recalled that he wanted to provide HST time for this work because he believed HST provided superior data on the supernovae.¹⁴ Later, long after changing his mind, Kirshner recalled, "While our original motivation for using HST was the wonderful imaging that makes photometry more precise, we also benefited from the absence of weather and the fact that moonlight doesn't light up the sky when you are above the atmosphere. The observations took place exactly as planned, which hardly ever happens on the ground, and we could time them in the optimum way to learn about the light-curve shape[s]" of the supernovae.¹⁵

While much existing data in the 1990s pointed to a slowing rate of expansion for the universe, a few scientists questioned this idea. As members of both supernova search teams began to compile their data, it took them in an unexpected direction: the supernovae were dimmer than expected at their redshifts and distances. The data led to conclusions that the universe was expanding, and surprisingly, that the expansion was accelerating, not decelerating. These

findings were so shocking that members of both teams held back on publication while they rechecked their figures and looked for another cause for this extraordinary result. Early in 1998, the teams announced their findings. The first paper came from the SCP team in January, with Perlmutter as the lead author, and was based on observations of 42 type Ia supernovae. Their data showed that the universe would expand forever. The High-*z* team based their February paper on a study of 16 type Ia supernovae. The lead author was Adam G. Riess, then a postdoctoral researcher at the University of California at Berkeley. Although this paper featured more data on fewer supernovae, the data were sufficient for the team to state that the universe's expansion was accelerating. Since similar data came from two independent sources and attempts to find alternative explanations failed, the stunning idea of the accelerating universe won relatively quick acceptance from the scientific community. Subsequent studies of supernovae and research of other aspects of the nature of the universe have backed up this new view of the universe.¹⁶ By 2001, Riess was on the staff of the Space Telescope Science Institute, and it was there that he found archival data obtained by HST's NICMOS instrument of Supernova 1997ff that confirmed that the universe was expanding at an accelerating rate.¹⁷

These findings, which mean that the universe will continue to expand indefinitely, overturned many prevailing models of the universe. The cause of



▲ Adam Riess speaks at the HST 25th anniversary event in 2015. (NASA/Joel Kowsky)

the acceleration of the expansion of the universe remains unknown, and so the most popular explanation amongst physicists is that it is a mysterious force they call dark energy. Puzzled physicists are asking if the accelerating expansion means that Albert Einstein had been right when he postulated in 1917 that there was a cosmological constant representing energy in the vacuum of space—an idea he later famously recanted. Sixty-eight percent of the mass-energy content of the universe is accounted for by dark energy. The work on the expansion of the universe done by the High-z and SCP teams led to many prestigious awards, notably the 2011 Nobel Prize for physics, which was presented to Brian Schmidt and Adam Riess of the High-z team, and Saul Perlmutter of

Near-Infrared Camera and Multi-Imaging Spectrometer (NICMOS)

Time on HST:

13 February 1997–present

Contractor:

Ball Aerospace

Principal Investigator:

Rodger I. Thompson
(University of Arizona)

Weight: 347 kilograms
(765 pounds) at launch,
391 kilograms (851 pounds)
after repairs in 2002

Axial Instrument

Near Infrared Camera and Multi-Object Spectrometer

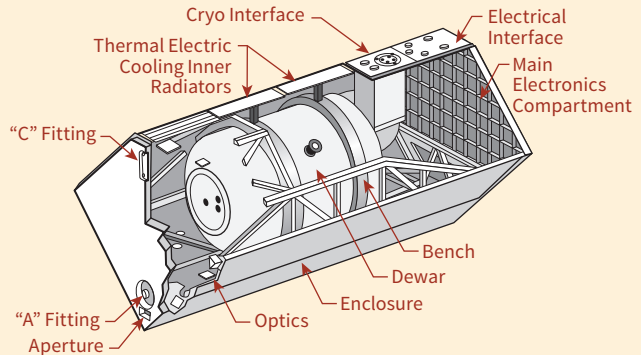

The Near-Infrared Camera and Multi-Imaging Spectrometer (NICMOS) provided HST with infrared imaging and spectroscopic capabilities in the near-infrared part of the spectrum. NICMOS is equipped with three cameras using non-CCD detectors that could operate simultaneously, each with its own resolution and field of view. Each camera has a set of filters and can obtain data in wavelengths between 0.8 and 2.5 microns. These cameras could also operate as a spectrometer and polarimeter,

SCP. In addition to HST's role in the work of both teams, the prize relates to HST in the form of Riess' affiliation with STScI.¹⁸

DEEPENING MYSTERIES

While the idea that the universe is expanding at an accelerating rate remains unchallenged, results from other spacecraft have raised questions about the estimates of the universe's size and age from HST and other optical telescopes. This started in 2003 when NASA released the first year results from the Wilkinson Microwave Anisotropy Probe (WMAP) following its launch in 2001. WMAP obtained imagery of the entire sky from early in the history of the

and one could act as a coronagraph, blocking light from a bright object to observe a nearby dim object. NICMOS's internal optics were designed to compensate for the effects of spherical aberration in HST's main mirror.

To operate in the infrared, NICMOS' cameras must be cooled to very cold temperatures, about minus 355 degrees Fahrenheit or 58 degrees Kelvin. When it was launched, NICMOS was equipped with a cryogenic dewar containing frozen nitrogen. Soon after it was installed on HST during Servicing Mission 2 in 1997, NICMOS began losing nitrogen coolant, which ran out in 1999.

NICMOS was shut down while NASA developed a new mechanical cooling system that was installed by Shuttle astronauts during Servicing Mission 3B in 2002. The instrument regained its capabilities in the infrared when the new NICMOS Cooling System was installed, and it operated successfully until it failed to restart after a planned temporary shutdown in September 2008. Because of concerns about restarting the cryocooler and because WFC3 also had a strong infrared capability, NASA decided that NICMOS should remain in hibernation.^a

While it was operating, NICMOS provided imagery and other data from faraway galaxies, newly formed stars, and objects obscured by dust and gas. It was also used to view objects in the solar system, and archival data from NICMOS were later reprocessed with new techniques to reveal extrasolar planets.^b

^a Space Telescope Science Institute, *Near-Infrared Camera and Multi-Object Spectrometer Instrument Handbook for Cycle 17, Version 11.0* (Baltimore, MD: STScI, June 2009).

^b NASA, "Astronomers Find Elusive Planets in Decade-Old Hubble Data," news release 2011-315, 6 October 2011.

universe in the afterglow of the Big Bang, called the cosmic microwave background, at higher definition than before. The European Space Agency's Planck spacecraft obtained higher definition data on the early days of the universe following its launch in 2009. The findings from WMAP and Planck about the age of the universe did not match those obtained by astronomers using HST and other telescopes. Based on data from WMAP and Planck, the age of the universe is now thought to be close to 13.8 billion years.

Astronomers have continued using HST to refine the Hubble constant and our knowledge of the universe's expansion rate. A group of astronomers headed by Riess that grew out of the High-*z* team formed the Supernovae H0 for the Equation of State (SH0ES) group in 2005 with the aim of reducing the uncertainty in estimates of the expansion rate. The group set about to refine our knowledge at the base of the cosmic distance ladder used to estimate distances in the universe by imaging Cepheid variables in the Large Magellanic Cloud and other nearby galaxies, using HST instruments to provide more accurate estimates of their distance than those obtained using less powerful telescopes on the ground. In 2019, Riess and SH0ES announced that they had reduced the uncertainty in the value of the Hubble constant to 1.9 percentage points around a figure of 74 kilometers per second per megaparsec, a figure meaning that for every 3.3 million light-years farther away a galaxy is from us, it appears to be moving 74 kilometers per second faster. This number indicates that the universe is expanding at a 9 percent faster rate than the prediction of 67 kilometers per second per megaparsec based on Planck's observations of the early universe. "This is not just two experiments disagreeing," Riess explained in a news release. "We are measuring something fundamentally different. One is a measurement of how fast the universe is expanding today, as we see it. The other is a prediction based on the physics of the early universe and on measurements of how fast it ought to be expanding. If these values don't agree, there becomes a very strong likelihood that we're missing something in the cosmological model that connects the two eras."¹⁹

To add to the riddle of the different figures for the Hubble constant, a group headed by Wendy Freedman, who had moved to the University of Chicago since her work on the Hubble Key Project, published research in 2019 based on a different way of estimating the Hubble constant from Cepheid variables or supernovae. This method uses measurements of red giant stars, which are stars very late in their lives, to deduce their distances. Freedman's team's estimate of the Hubble constant was 69.8 km/sec/Mpc, in between the estimates from Riess' team and Planck. "Naturally, questions arise as to whether the discrepancy is coming from some aspect that astronomers don't yet understand about

the stars we're measuring, or whether our cosmological model of the universe is still incomplete," Freedman said. "Or maybe both need to be improved upon."²⁰

Astrophysicists will work in the years to come on problems such as the discrepancies between various ways of measuring the Hubble constants, and the larger and far more baffling questions surrounding the expansion of the universe and the concept of dark energy. The answers to these questions may involve revolutionary changes to present day beliefs about physics that some call a new physics, and this work will likely require the help of upcoming astronomical instruments, such as the James Webb Space Telescope and the Nancy Grace Roman Space Telescope.²¹

DARK MATTER, BLACK HOLES

It is important to note that dark energy, which is believed to be driving the expansion of the universe, is distinct from dark matter, a mysterious transparent form of matter. Astronomers, starting with Fritz Zwicky in the 1930s and most famously Vera Rubin in the 1970s, observed that the visible matter in the universe was not adequate to explain the motion of galaxies, stars, and other bodies. Zwicky and others proposed this mysterious form of matter as the explanation for this problem. Astronomers now estimate that dark energy accounts for 68 percent of the universe and about 27 percent of the universe is dark matter, leaving only about 5 percent of the universe as visible matter. Astronomers are continuing their quest to understand the nature of dark matter using HST and telescopes on Earth by looking for signs of dark matter's effects on visible objects by mapping the locations of galaxies and galactic clusters and looking for gravitational lensing, where gravity is seen to bend light from more distant objects as predicted by Einstein's theory of relativity. The degree of gravitational lensing can be compared to the presence of visible matter to deduce the presence of dark matter. HST images, such as a 2006 image of colliding galaxies in the Bullet Cluster, contain evidence of dark matter.²²

In addition to the difficult questions relating to the age of the universe and the mysteries of dark matter, astronomers used HST together with other facilities to learn more about the details of every kind of body in the universe. Ken Carpenter, for example, started his scientific work on HST using the Goddard High Resolution Spectrograph to learn about the winds in the upper atmospheres of cool, evolved stars. GHRS was also used by other scientists to learn about the interstellar medium—the gas, dust and radiation that can be found between star systems—and much of that research moved to STIS when it replaced GHRS in 1997. Spectrographs attached to HST provided vital information about the composition and motion of celestial bodies throughout the universe.²³

One of HST's most significant findings concerns the relationship between galaxies and supermassive black holes. Black holes are typically formed during the deaths of massive stars and have masses of about 20 times that of the Sun, but black holes found at the centers of galaxies have masses millions or even billions of times larger. One of HST's three Key Projects when it began operations was focused on quasi-stellar



▲ Hubble Operations Project Scientist Ken Carpenter in 2018. (NASA/W. Hrybyk)

objects or quasars, and it found that these brilliant objects are, in fact, supermassive black holes surrounded by gaseous accretion disks that are located inside galaxies that they vastly outshine. Observers using HST also found that the masses and motion of stars and other matter in the central bulges at the centers of galaxies pointed to the existence of supermassive black holes in virtually all of these galaxies, confirming suggestions from ground-based observations. These observations help explain many questions around the evolution of galaxies, including our own, tying the development of galaxies with that of the supermassive black holes that lie at their centers.²⁴

COSMIC CORE SAMPLES

Scientists looked to HST as a means of looking deep into the universe and long into its past because of the time needed for light to travel from distant reaches. One way to do that was with very lengthy exposures to view objects at extreme distances from Earth. While spacecraft such as the Cosmic Background Explorer (COBE), WMAP, and Planck gathered data outside optical wavelengths to map the cosmic background radiation that was created immediately after the Big Bang, astronomers hoped that by taking long exposures in parts of space that appear empty from the ground, HST would be able to image galaxies as they were forming early in the history of the universe.²⁵ The third of HST's original Key Projects was a Medium Deep Survey that was aimed at seeking out distant young galaxies.²⁶ Other astronomers wanted to look longer and deeper into space, but this idea was not universally supported. In the month that HST

was launched, one of the world's top astrophysicists, John Bahcall, cowrote a paper in *Science* predicting that long exposures with HST would not reveal galaxies in long exposures that could not be seen from the ground.²⁷ Bahcall was not alone in his view. "Personally, I thought it was a dumb idea," Robert Kirshner said of the plan for long exposures into what appeared to be empty space.²⁸ Lyman Spitzer also opposed such a long observation.

Robert E. Williams, who became the second director of the Institute in 1993, had originally found the calculations in Bahcall's paper "quite sensible." But Williams' interest in a long, deep exposure grew when he saw the results from a series of lengthy exposures of a galactic cluster made in May and June of 1994 with the newly installed WFPC2. The exposures, which included one of 18 hours taken over 32 orbits, revealed what a news release called a "cosmic zoo."²⁹ A group of young STScI postdocs including Mark Dickinson had won approval for the images through HST's peer review process. At the time, science staff at the Institute took part in daily morning "science coffee" sessions at the STScI library. Williams made it a point to attend as many of these discussions as he could, and when Dickinson made a presentation about his results, the director was "blown away by it." Williams, who controlled the 10 percent of HST's observing time that was designated as director's discretionary time, began to consider using much of that time for a much longer set of exposures that would be made immediately available to everyone, instead of waiting for a proposal from observers that would go through the regular approval process. Those regular observations were subject to restrictions on publication during the first year after the data were downloaded. Williams convened a 12-member advisory committee to consider how to use the observing time. When the committee met on 31 March 1995, its expert members differed on many details,



▲ Robert Williams, second director of STScI. (STScI)



▲ The historic “Hubble Deep Field” image, based on 342 separate exposures taken of an area inside the constellation Ursa Major by WFPC2 between 18 and 28 December 1995, was released on 15 January 1996. (NASA/STScI)

including the number of fields, the number of filters to use, and whether to point at an empty field or one containing a cluster or a quasar. “And so I essentially made the decision to undertake the Deep Field, rather than the alternative” of awaiting a proposal from the community, Williams said.³⁰

Once the decision was made, Williams assembled a team of postdoctoral researchers to undertake a year of planning for the image, which became known as the “Hubble Deep Field.” Based on imagery obtained from Kitt Peak, the team chose what appeared to be an empty part of the sky near the handle of the Big Dipper in Ursa Major. This spot, whose dimensions were compared by STScI to the width of a dime held 75 feet (23 meters) away, is far from the plane of our own galaxy, so it is free of nearby stars or other objects, and it is located in HST’s continuous viewing zone, where the telescope can observe

without being blocked by Earth, the Sun, or the Moon. During 150 orbits from 18 to 28 December 1995, WFPC2 took 342 separate images using different filters. Although there was strong interest in looking for galaxies with strong redshifts that by definition were distant, filters were chosen to provide a data set that could answer a number of questions relating to the evolution of galaxies at many distances and ages. Initial examination of the imagery showed 1,500 galaxies at various stages of their evolution, going back to the earliest epoch in the history of the universe. In the 17 days that followed the end of the observations, the team worked around the clock to calibrate and process the data for public release on 15 January 1996, when the entire trove of data was made available to the world during a meeting of the American Astronomical Society in San Antonio, Texas.³¹

MORE DEEP FIELDS

The “Hubble Deep Field” was an immediate hit with both the public and scientists, becoming an early phenomenon on the internet, as discussed in chapter four. “I believe that the HDF [“Hubble Deep Field”] changed the culture of astronomy,” Williams said.³² Others, such as University of Washington astronomer Julianne J. Dalcanton, agreed. “This coming together of the community to generate a shared, nonproprietary data set was essentially unprecedented but has since become the model for the majority of large astronomical projects,” she wrote later. “Almost all major astronomical surveys are now proposed with the expectation that the data and data products will be publicly released during the project, rather than held in perpetuity by those few who instigated the programme. This new mode of operating has democratized astronomy by opening astronomical research to scientists that are at relatively under-resourced institutions, allowing researchers at small colleges, or in poor countries, to have access to some of the finest data sets in the world.”³³

Williams was also gratified by the successful careers of the postdocs who created the deep field. “The deep field showed the importance of giving an individual such as the institute director responsibility for a major portion of telescope time,” he said. “I think most people would agree that it would have been really unlikely that anything like the HDF could have gotten by a peer review committee involved in it. There was no guarantee of success.”³⁴

The unprecedented release of such a large amount of data inspired others in the astronomical community to make spectroscopic observations of the distant galaxies shown in the HDF. A photometric redshift method that previously had been used only for nearby galaxies allowed relatively easy distance estimates for the galaxies shown in HDF imagery. The original data set obtained for the



▲ This “Hubble Ultra Deep Field” image is based on exposures taken from 2002 to 2012 of a small area in the constellation Fornax with HST’s Advanced Camera for Surveys and Wide Field Camera 3. (NASA/STScI/ESA)

deep field was supplemented, starting with infrared imagery obtained in 1997 and 1998 by the NICMOS instrument installed on HST in 1997. As previously noted, Adam Riess went to the STScI archive in 2001 and used HDF imagery and some of this NICMOS imagery to supplement earlier work done on supernovae by the High-z and SCP groups. With this data, Riess verified their findings on the acceleration of the expanding universe.³⁵

The original “Hubble Deep Field” results led to further deep field observations. Another apparently empty area in the constellation Tucana was imaged in October 1998 using WFPC2, STIS, and NICMOS, with the resulting observations referred to as the “Hubble Deep Field South.” In 2003 and 2004, HST used its new Advanced Camera for Surveys to obtain the “Hubble Ultra Deep Field” in an area in the southern constellation Fornax. The HUDF represented humankind’s deepest view into the universe with optical wavelengths to that

date, nearly 95 percent of the way back to the Big Bang, showing the earliest and deepest galaxies visible in optical wavelengths. While the original HUDF included infrared imagery obtained by NICMOS, the vastly greater infrared capabilities of Wide Field Camera 3 led to the creation in 2009 of the “Hubble Ultra Deep Field–Infrared.” In 2012, astronomers combined HST imagery from “HUDF,” “HUDF–Infrared,” and other HST imagery of the area totaling 22 days of observing time to create humankind’s deepest view ever of the universe, the “Hubble eXtreme Deep Field,” or “XDF.” This massive data set was enhanced two years later with the addition of ultraviolet data from ACS and WFC3.³⁶ The Hubble Deep Fields gave astronomers a new and surprising view of the evolution of the universe. Galaxies were found in these images to exist as far back as 500 million years after the Big Bang, and in the words of STScI astrophysicist Mario Livio, they “challenged ideas about how the first stars formed, heated and re-ionized the universe.”³⁷ The deep field data also challenged previous ideas about the evolution of galaxies with evidence that young galaxies grew out of fragments—leading to a model of galaxy formation by continual merger and accretion of matter over time.³⁸

Williams’ successors Steven Beckwith and Matt Mountain supported further deep field campaigns with director’s discretionary time, and in 2012, Mountain asked the Hubble Deep Fields Initiative committee to draw up a program for a new deep field initiative aimed at imaging galaxies at distances that went beyond the previous deep fields. The result was known as the Frontier Fields, and from 2013 to 2016, 840 orbits of HST time were dedicated to imaging six clusters of galaxies and more distant galaxies made visible by the effects of the massive gravity associated with those clusters, along with six nearby regions. By 2017, Frontier Fields had grown to include imagery from the Chandra X-Ray Observatory and the Spitzer Space Telescope, which together with the HST data provided information about the physics of galaxy cluster mergers, and of the distant galaxies found by gravitational lensing, in preparation for observations at even greater distances (and deeper into the past) with the James Webb Space Telescope.³⁹

TREASURY PROGRAMS

After HST’s fourth servicing mission in 2009, NASA and STScI began a new class of large-scale HST observations called Multi-Cycle Treasury Programs to focus on major scientific problems and create collections of data for astronomers to exploit well beyond Hubble’s lifetime. Out of 39 proposals received, a specially chosen peer review panel selected four, including two similar proposals that were merged into a single observing program. The three remaining programs

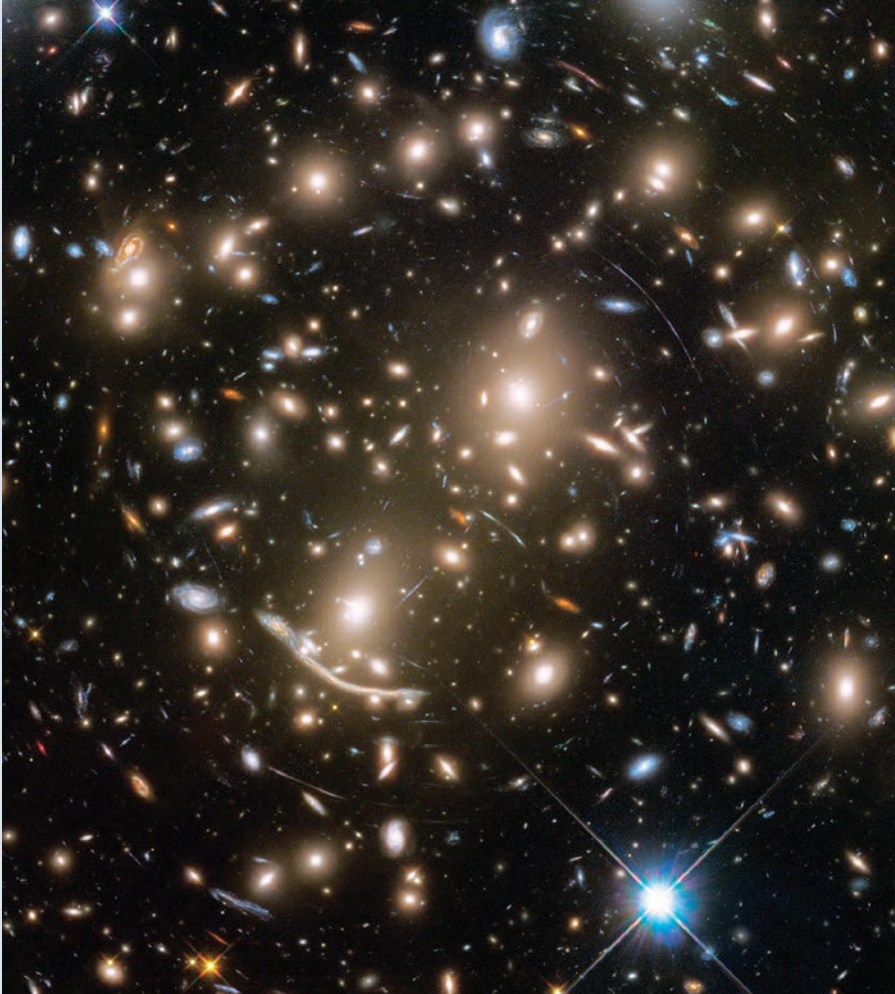

▲ This stunning image released in 2017 shows a cluster of hundreds of galaxies about 4 billion light-years away in the constellation Cetus called Abell 370. About 100 galaxies in this image appear multiple times due to the effects of gravitational lensing, and remote galaxies that otherwise could not be seen, appear as distorted images due to the same cause. This Frontier Fields image in visible and near-infrared light was obtained by the Advanced Camera for Surveys and Wide Field Camera 3. (NASA/STScI/ESA)

were CANDELS, the Cosmic Assembly Near-infrared Deep Extragalactic Legacy Survey; CLASH, the Cluster Lensing and Supernova Survey; and PHAT, the Panchromatic Hubble Andromeda Treasury. CANDELS was the largest observing program in the history of HST, with 902 orbits using WFC3 and ACS. The program surveyed galaxies and supernovae in the distant universe, giving astronomers glimpses of galaxies early in their evolution, and grew

out of earlier work in the Great Observatories Origins Deep Survey (GOODS) program that brought together data from the original Hubble Deep Fields with observations from other observatories including Chandra, Spitzer, ESA spacecraft Herschel and XMM-Newton, and ground-based observatories. CLASH aimed to examine the distribution of dark matter in massive galaxy clusters with greater precision than ever before. Imagery showing the effects of gravitational lensing is one means of detecting dark matter, and CLASH followed on earlier studies on HST and other instruments have focused on trying to gain a better understanding of dark matter. The PHAT team was awarded 834 orbits to image the northeast quadrant of M31, the Andromeda galaxy, with WFC3 and ACS in a variety of wavelengths. Because M31 is the closest large spiral galaxy to the Milky Way, about two and a half million light-years away, it is a great place to examine galactic structure down to individual stars. Such studies are not possible in other galaxies that are farther away or even in our own galaxy, where gas and dust obscure large parts of our view.⁴⁰

OUR DYNAMIC SOLAR SYSTEM

From its earliest days on orbit, the Hubble Space Telescope has also made important ongoing observations of the solar system we live in. Even before its spherical aberration problem was fixed, HST provided higher quality images and spectrographic data from the planets Jupiter, Saturn, and Mars than had been previously available. Prior to 1990, these planets had only been observed through Earth's atmosphere or from visiting spacecraft. Early HST data from within the solar system showed that the space telescope could deliver quality science despite its mirror problem. But an event unprecedented in human memory proved to the world in 1994 that the repaired HST was operating as scientists had originally hoped.

Astronomers Carolyn and Eugene Shoemaker and David Levy took a set of photographs on 24 March 1993 using the 46-centimeter (18-inch) Schmidt telescope at the Palomar Observatory as part of a survey of comets and asteroids, including one that revealed the ninth periodic comet that the trio had discovered. The comet had an unusual bar-like appearance, which was determined to be the result of multiple fragments at its heart instead of a core. As astronomers gathered more information about the comet's path, they found that the comet was orbiting Jupiter rather than the Sun, and that when the comet passed very close to Jupiter in July 1992, it broke into fragments that were on a collision course with Jupiter. The fragments were projected to strike the giant planet from 16 to 20 July 1994, and astronomers around the world mobilized in hopes of seeing the effects of the impacts, which would take place behind Jupiter

as seen from Earth. HST, equipped with its new WFPC2 camera, and the Galileo spacecraft, then on its way to Jupiter, would also image the impact areas. During the months that preceded the impacts, HST and telescopes on Earth followed the comet fragments that were spreading out into a “string of pearls” heading to Jupiter.⁴¹

On 16 July 1994, when the first fragment struck Jupiter, a large crowd of scientists and media gathered in the main auditorium at STScI to watch images come in from HST. HST’s images of the plume created by the fragment’s impact, which was visible on the limb of Jupiter, caused scientists to cheer and reporters to trumpet the success of HST’s new camera. Soon HST images showed a black cloud at the top of Jupiter’s cloud decks when the impact site rotated into view. During the week that followed, HST provided many more images and spectrographic data of the fragment impacts and the marks they left for a time on Jupiter. Members of the HST imaging team for SL-9 were at the control center making real-time calls about Hubble observations, a highly unusual event for HST. Hubble’s contribution to the trove of data collected at the time was especially important because it could record light in wavelengths not visible from Earth’s surface. The impact week turned into a major astronomical event as the impacts were visible to telescopes around the world, including small telescopes used by amateur astronomers. While observations of the impacts provided new information on the dynamics of large impacts and the structure of Jupiter’s atmosphere, the event drove home to scientists and lay people alike the importance of impacts in the history of our solar system. Fifteen years later, another object left a large dark spot on Jupiter.⁴² “Things hit other things,” explained planetary astronomer Heidi Hammel, who led the team that used HST to image the 1994 comet crash. “The solar system is a dynamic place.”⁴³



▲ Image of Mars from WFPC2 during its close passage to Earth on 27 August 2003, when the two planets were only 35 million miles apart. (NASA/STScI)

Although several spacecraft visited Jupiter and Saturn during HST's lifetime, the space telescope provided important backup by regularly tracking changes in the gas giants through images of the planets in their entirety, their rings and their moons. HST also helped prepare the way for spacecraft flying to the outer planets. Before HST was launched, two Pioneer and two Voyager spacecraft had obtained data on Jupiter from space during flybys in the 1970s. The Galileo spacecraft orbited the planet between 1995 and 2003, and the Juno orbiter arrived in 2016. Spacecraft such as Ulysses, Cassini, and New Horizons also obtained data from Jupiter during their Jovian flybys. HST imagery tracked the shrinkage of its Great Red Spot to its smallest recorded size. Other HST observations provided important information about Jupiter's magnetic field and included ultraviolet images of aurorae on both Jupiter and Saturn. HST has also made regular observations of Jupiter's moons, particularly the four Galilean moons. Hubble has followed volcanic activity on Io and found spectroscopic

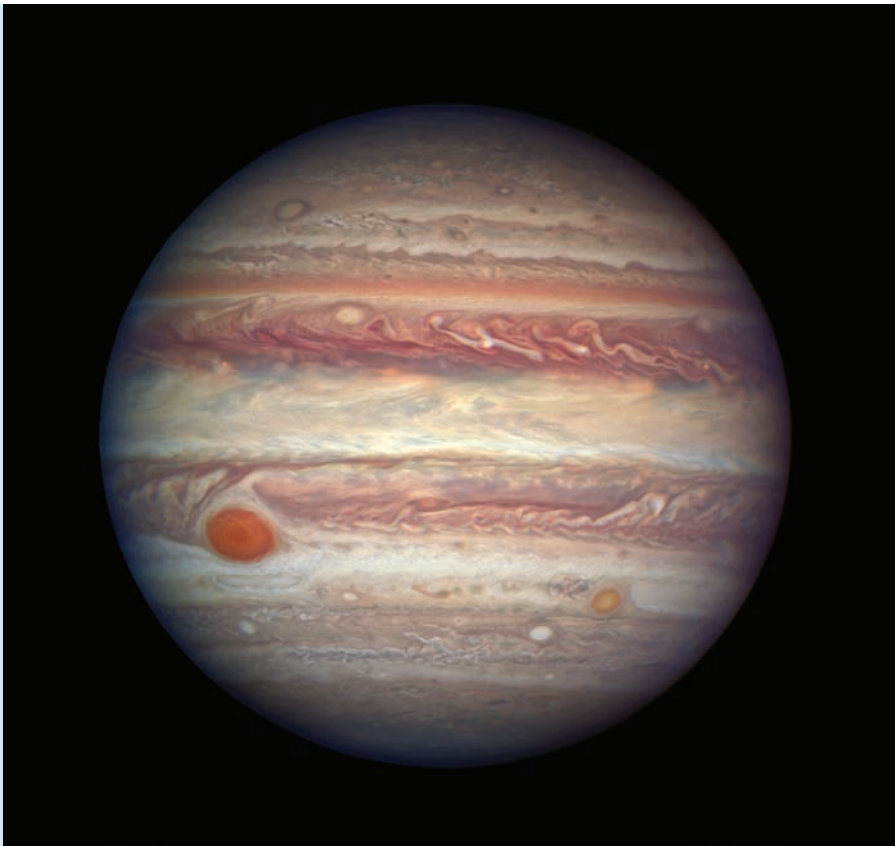

▲ Wide Field Camera 3 image of Jupiter taken on 13 April 2017. (NASA/STScI)

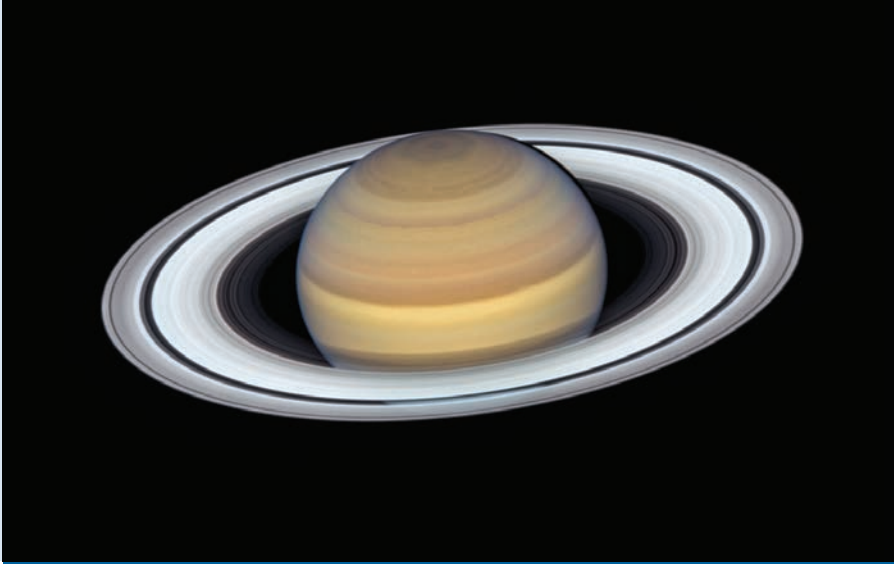

▲ Saturn as seen by Wide Field Camera 3 on 20 June 2019. (NASA/STScI/ESA: STScI-2019-43)

evidence of hydrogen and oxygen, the elements that together make water, in the atmosphere of Europa. Some of the best evidence for an underground salt-water ocean on Ganymede was found by HST observations. At Saturn, Hubble complemented findings from the short-lived explorations of Pioneer 11 and the two Voyagers, along with Cassini's findings from 2004 to 2017, with studies of the changes in Saturn's atmosphere and its famous rings. HST also discovered previously unseen moons orbiting Saturn and found that the orbit of the moon Prometheus had changed since it was first observed by Voyager 1. HST images of Saturn's moon Titan helped prepare the way for the ESA Huygens probe that landed on Titan in 2005 after separating from Cassini.⁴⁴

HST also obtained high-resolution images of Uranus and Neptune, which are difficult to image from the ground. Much of what astronomers previously knew about these two planets came from observations by Voyager 2, which flew by Uranus in 1986 and Neptune in 1989. Uranus had a very bland appearance in 1986, but when Hubble began imaging the planet as part of a study of its moons, Uranus exhibited bright clouds that showed up better in the infrared than in the visible wavelengths imaged by Voyager. HST later observed seasonal changes on Uranus, which is tipped over on its side, causing the poles to sometime point at the Sun. Neptune's dark spot seen by Voyager 2 was gone when HST first viewed the planet, and after that the planet displayed a variety of dark spots, none as large as the one seen by Voyager.⁴⁵ For all the outer planets, Hubble was able to monitor changes in their atmospheres over the years.

Building on already available HST data, the Outer Planet Atmospheres Legacy (OPAL) program began in 2014 to follow trends in winds and cloud activity on Jupiter, Saturn, Uranus, and Neptune and better understand the dynamics of their atmospheres.⁴⁶

Pluto, at the time of HST's launch considered the ninth planet in the solar system, is the best example of how HST could enhance the work of another spacecraft. Pluto is so far away and so small that even the most powerful telescopes on Earth could not resolve surface features. Pluto was discovered in 1930 by Clyde Tombaugh at the Lowell Observatory in Arizona, and its moon Charon, which has half the diameter of Pluto, was not discovered until 1978. In 1994, HST imaged Pluto and Charon, resolving them as round discs, and a set of Faint Object Camera images taken in March 1996 showed that Pluto's surface had many high contrast features. The features could not be clearly resolved, however, and the images remained among the best of Pluto until the New Horizons spacecraft flew by on 14 July 2015. During the nearly 20 years between those images, astronomers using ground-based telescopes discovered other objects in the Kuiper Belt beyond Neptune, with some a similar size to Pluto. HST later imaged some of these bodies. In 2006, the International Astronomical Union created a new definition for planets, and reclassified Pluto as a dwarf planet along with bodies in the asteroid belt and the Kuiper belt. Once installed aboard HST, ACS, and WFC3 were used to image slightly better views of Pluto and discovered four small moons: Nix, Hydra, Styx, and Kerberos, and caused New Horizons mission planners to exercise great caution in charting the best course for the probe ahead of its flyby. Scientists planned to fly New Horizons past another Kuiper Belt body after it encountered Pluto, but when other telescopes failed to find a suitable target, New Horizons investigators obtained HST time in 2014. After Hubble found two suitable objects, New Horizons scientists decided in August 2015 to direct the spacecraft to an object called 2014 MU69 and later named Arrokoth. With the assistance of further HST observations to verify navigational estimates, New Horizons completed a successful flyby of this primordial object on 1 January 2019.⁴⁷

As it does for the outer planets, HST also monitors the planet Mars and follows changes in its atmosphere. Hubble observations have also assisted spacecraft heading to the surface of the Red Planet by watching for storms. In order to avoid aiming itself at the Sun, HST never makes observations of Mercury, and only rare observations of Venus. HST has made only occasional observations of the Moon.⁴⁸ Hubble also made a number of asteroid observations, most famously imaging an x-shaped debris field following an asteroid after a collision, and another with multiple dust trails. HST found comets dwelling

beyond Neptune, answering questions about the source of short-period comets that take less than 200 years to orbit the Sun, including comets Encke and Giacobini-Zinner. In 2017, HST obtained images of the farthest active inbound comet ever seen. The comet, known as K2, was found by a survey camera in Hawaii and imaged using WFC3 while it was still outside Saturn's orbit.⁴⁹

STARS AND THEIR PLANETS

HST has helped astronomers tell the life stories of stars from their formations to their sometimes explosive deaths. The birth and death throes of stars have provided some of the most memorable and beautiful images from Hubble, such as those of stellar nurseries in the Orion Nebula, the Carina Nebula, and what have become known as the "Pillars of Creation" in the Eagle Nebula after the famous 1995 HST image discussed in chapter four. The image shows newly born stars emerging from colossal clouds of cold hydrogen gas that are being struck by a torrent of ultraviolet radiation from nearby young stars. This was just one of the mechanisms shown by HST to affect the lives of emerging stars. Other HST images showed bipolar jets from newly formed stars, and Hubble has even produced movies of these jets. Hubble showed that many stars form inside protoplanetary discs or "proplyds" of gas and dust that are quite visible and common in star forming regions. C. Robert O'Dell, who previously steered the space telescope through the shoals of political approvals and construction problems as Project Scientist from 1972 to 1982, made these important observations starting even before HST's spherical aberration was corrected. Although astronomers were already imaging these structures before Hubble flew, they were not believed to be as common as the HST data has shown.⁵⁰

At the other end of stellar lifespans, many of Hubble's signature images show stars in their death throes. Many stars, including one day our own Sun, will die relatively gracefully by ejecting their outer gaseous layers, which are then lit up by the exposed core of the star. These bodies are known as planetary nebulae, and vary widely in form and shape. Famous planetary nebulae imaged by HST include the Ring Nebula, Helix Nebula, Cat's Eye Nebula, and NGC 2392. Some stars much larger than our Sun end their existence exploding as supernovae. Astronomers' interests in novae and supernovae go far beyond their utility as "standard candles" to measure distances between galaxies. HST's research into the nature of supernovae was given a big assist by the fact that a supernova appeared in one of our neighboring galaxies, the Large Magellanic Cloud, on 23 February 1987. HST, launched three years later, has been used to follow the evolution of Supernova 1987A, including the collision between a shockwave from the explosion and two previously existing lobes of gas around the star,

creating an effect that resembles three rings. These data have also filled many of the gaps in our knowledge of the life cycles of galaxies and the universe.⁵¹

Many stars are now known to have their own planetary systems. These planets orbiting stars other than our Sun are known as exoplanets. At the time of HST's launch, no planets had been found around stars other than our own. While there was media speculation that HST would be used to find them, there were no plans at the time to use HST for this purpose because its narrow field of view makes it unsuitable for surveys that would be necessary to find extrasolar planets. Distinguishing such planets optically is extremely difficult because reflected light from any planets is overwhelmed by light from their parent star, so indirect methods are therefore necessary to find them. In October 1995, a Swiss team headed by Michel Mayor and Didier Queloz announced the first verified discovery of an exoplanet, a Jupiter-sized planet orbiting close to the star 51-Pegasi, using a telescope in France. Soon other Earthbound observers, most famously the American astronomers Geoffrey Marcy and Paul Butler, began discovering exoplanets.

These discoveries were made using Doppler spectroscopy, which uses a spectrograph to find subtle changes in a star's velocity caused by the gravitational pull of a planet orbiting it.⁵² Another method called transit photometry looks for the tiny reductions in light due to a planet passing in front of a star as seen from Earth. After Earth-based observations showed how this method could yield evidence efficiently, the Kepler spacecraft was launched by NASA in 2009 and the Transiting Exoplanet Survey Satellite or TESS in 2018 specifically to search photometrically for exoplanets. A third method, known as microlensing, uses the relativistic effects of massive objects to magnify the light from a star lying directly behind the massive object. While more than 4,000 exoplanet discoveries have been confirmed to 2020, many of them from Kepler, HST has concentrated on some of the more interesting cases.⁵³ One claim in 1998 that HST had directly imaged an exoplanet was later disproven, and an object first imaged by HST in 2004 orbiting the prominent southern hemisphere star Fomalhaut has since disappeared from view.⁵⁴

Though not involved in most initial discoveries of exoplanets, Hubble has made a major and pioneering contribution to the study of exoplanets by using its spectroscopic instruments to learn about the properties of these bodies, including the makeup of their atmospheres. In 2001, HST became the first observatory to directly detect the atmosphere of an extrasolar planet. When the planet passed in front of its star, HD 209458 in Pegasus, images obtained by STIS showed the presence of sodium in its atmosphere. Since then, HST and the Spitzer Telescope have examined the atmospheres of exoplanets when they

transit stars, and HST has found clouds in some atmospheres and the presence of oxygen, carbon, hydrogen, carbon dioxide, methane, and water vapor.⁵⁵

FIRST AMONG EQUALS

Almost every part of this survey of scientific discovery takes note of the fact that HST has worked in tandem with other instruments on Earth and in space to make discoveries. Although HST incorporates many unique capabilities and major advances in technologies, historian Robert Smith noted that it has not dominated observational astronomy in the way that the Hale Telescope on Mount Palomar did in the third quarter of the 20th century. “While we can argue that HST has assumed *the* leading role in observational astronomy, it is playing its part alongside a much stronger supporting cast than would have been the case even a decade earlier,” he said. This is shown by the use of other instruments to add to the data sets first created for the Hubble Deep Fields. Smith wrote that Hubble has contributed “in very significant ways to a remarkably wide range of astronomical problems.”⁵⁶ Prominent astrophysicist and author Mario Livio summed up HST’s work in a similar way, saying, “Hubble’s greatness lies not so much in the singular discoveries that it has made as in confirming suggestive results from other observatories. As new details have become visible, astrophysicists have had to refine their theories about the universe.”⁵⁷

Today our understanding of the universe is vastly different from what it was when HST first reached orbit. Many old beliefs have been contradicted in spectacular fashion, and new mysteries such as dark energy have emerged to confound observers. The universe is a bigger, more complicated, and more colorful place than what it appeared to be before HST was launched. The findings related in this chapter are far from the last word on HST’s scientific output, because Hubble is still producing high quality observations with its latest set of instruments. As will be discussed in chapter nine, many HST observations are already in archives waiting to be examined and analyzed, a process that will continue long after HST stops functioning. Hubble’s most important contributions to science may still lie in the future.

ENDNOTES

- 1 Ken Carpenter, oral history interview by author, part 1, 30 April 2015, pp. 14–15.
- 2 Livio, “Hubble’s Legacy;” STScI, “HST Publication Statistics,” <https://archive.stsci.edu/hst/bibliography/pubstat.html> (accessed 20 October 2017).
- 3 Robert P. Kirshner, *The Extravagant Universe: Exploding Stars, Dark Energy and the Accelerating Cosmos* (Princeton: Princeton University Press, 2002), pp. 5–6.
- 4 E. J. Chaisson and R. Villard, “The Science Mission of the Hubble Space Telescope,” *Vistas in Astronomy*, vol. 33 (1990), pp. 105–141.
- 5 John Noble Wilford, “The Search for the Beginning of Time,” *New York Times Magazine* (11 February 1990): 33, 56; NASA, “STS-31 Press Kit,” p. 33; Smith, *The Space Telescope*, pp. 18–21. See Kirshner, *The Extravagant Universe*.
- 6 Robert W. Smith, *The Expanding Universe: Astronomy’s “Great Debate,” 1900–1931*. (New York: Cambridge University Press, 1982), pp. 71–77, 111–118; Christianson, *Edwin Hubble*, pp. 152–162; Robert W. Smith, “Hubble’s Law,” in James Trefil, ed., *Discoveries in Modern Science: Exploration, Invention, Technology* (Farmington Hills, MI: Macmillan Reference USA, 2014), pp. 511–522. For more on Leavitt, see Dava Sobel, *The Glass Universe: How the Ladies of the Harvard Observatory Took the Measure of the Stars* (New York: Penguin Books, 2016). Later work showed that the Andromeda Galaxy is more than twice as far from Earth as Hubble estimated. This does not affect the importance of establishing the nature of Andromeda and similar objects.
- 7 Smith, “Hubble’s Law”; and Helge Kragh and Robert W. Smith, “Who Discovered the Expanding Universe?” *History of Science* 41, no. 2 (2003): 141–162. Both papers discuss the context surrounding the adoption of the idea of the expansion of the universe. See also Edwin Hubble, “A Relation Between Distance and Radial Velocity Among Extra-Galactic Nebulae,” *Proceedings of the National Academy of Science* 15, no. 3 (1929): 168–173; Edwin Hubble and Milton L. Humason, “The Velocity-Distance Relation Among Extra-Galactic Nebulae,” *Astrophysical Journal* 74 (1931): 43–79; Christianson, *Edwin Hubble*, pp. 203–359.
- 8 STScI, “Hubble Takes Major Step in Determining the Age of the Universe,” news release STScI-1993-31, 9 June 1993.
- 9 Wendy Freedman, oral history interview by author, 6 September 2017, pp. 3–4; STScI, “Hubble Completes Eight-Year Effort to Measure Expanding Universe,” news release STScI-1999-19, 25 May 1999; Wendy L. Freedman et al., “Final Results from the Hubble Space Telescope Key Project to Measure the Hubble Constant,” *The Astrophysical Journal* 553 (20 May 2001): 47–72. Freedman said the project also made use of observations from the Canada-France-Hawaii Telescope and Cerro Tololo. A parsec is equal to 3.26 light-years, and a megaparsec is 3.26 million light-years.
- 10 Laura Ferrarese, “Measuring the Expansion Rate of the Universe,” in ed., David L. Goodstein, *Adventures in Cosmology* (Singapore: World Scientific Publishing Co. Ptc. Ltd., 2011), pp. 193–240 (quote on p. 224); Panek, *4% Universe*, pp. 85–87; Kirshner, *Extravagant Universe*, pp. 37–39, 139–141.

- 11 J. H. Elias et al., "Type I Supernovae in the Infrared and Their Use as Distance Indicators," *The Astrophysical Journal* 296 (15 September 1985): 379–389; Kirshner, *Extravagant Universe*, pp. 198–208; Ted Anton, *Bold Science: Seven Scientists Who Are Changing Our World* (New York: W. H. Freeman and Company, 2000), pp. 114–120.
- 12 Anton, *Bold Science*, p. 120.
- 13 Robert E. Williams, oral history interview by author, 21 May 2015, part 2, pp. 5–11; Robert Williams, Sadanori Okamura, and Nao Suzuki, "Round Table Talk: Conversation with Robert Williams," *Kavli IPMU News*, no. 35 (September 2016): 20–23; Nicholas Suntzeff, oral history interview by author, 8 June 2016, pp. 1–7; Robert Kirshner, oral history interview by author, 28 September 2016, pp. 1–4; Adam Riess, oral history interview by author, 20 May 2015, p. 2. See also Panek, *4% Universe*, pp. 111–114.
- 14 Suntzeff OHI, p. 2; Williams OHI, part 2, 8.
- 15 Kirshner, *Extravagant Universe*, p. 206.
- 16 John Noble Wilford, "Wary Astronomers Ponder An Accelerating Universe," *New York Times* (3 March 1998); John Noble Wilford, "In the Light of Dying Stars, Astronomers See Intimations of Cosmic Immortality," *New York Times* (21 April 1998); The Royal Swedish Academy of Science, *Scientific Background on the Nobel Prize in Physics 2011: The Accelerating Universe*, compiled by the Class for Physics of the Royal Swedish Academy of Science, 4 October 2011; Panek, *4% Universe*, pp. 141–163; Kirshner, *Extravagant Universe*, pp. 203–233. See also the SCP paper: Saul S. Perlmutter et al., "Measurements of Omega and Lambda from 42 High Redshift Supernovae," *Astrophysical Journal* 517, no. 6, (1999): 565–586; and the High-z paper: Adam G. Riess et al., "Observational Evidence from Supernovae for an Accelerating Universe and a Cosmological Constant," *The Astronomical Journal* 116, no. 3 (September 1998): 1009–1038. The High-z paper made greater use of HST data than did the SCP paper.
- 17 Kirshner, *Extravagant Universe*, pp. 246–249; Panek, *4% Universe*, pp. 176–180.
- 18 Royal Swedish Academy, *Scientific Background*; Panek, *4% Universe*, pp. 164–180; Kirshner, *Extravagant Universe*, pp. 235–243.
- 19 NASA, "First Year Results on the Oldest Light in the Universe," news release 03-064, 11 February 2003; STScI, "Mystery of Universe's Expansion Rate Widens With New Hubble Data," news release STScI-PR19-25, 25 April 2019; Riess et al., "A 2.4% Determinant of the Local Value of the Hubble Constant," *The Astrophysical Journal* 286, no. 1 (21 July 2016); Riess OHI, pp. 5–7.
- 20 STScI, "New Hubble Constant Measurement Adds to Mystery of Universe's Expansion Rate," news release STScI-PR-19-28, 16 July 2019.
- 21 NASA, "Improved Hubble Yardstick Gives Fresh Evidence for New Physics in the Universe," news release 2018-12, 22 February 2018; release, "New Hubble Constant Measurement," *Ibid.*
- 22 Gianfranco Bertone and Dan Hooper, *A History of Dark Matter*, Fermilab-Pub-16-157-A; Panek, *4% Universe*, pp. 50–54, 189–192.
- 23 Carpenter OHI, part 1, pp. 6–9. See also J. C. Brandt, T. B. Ake III, and C. C. Petersen, eds., *The Scientific Impact of the Goddard High Resolution Spectrograph* (Astronomical Society of the Pacific Conference Series, vol. 143, 1998).

- 24 Laura Ferrarese and Holland Ford, "Supermassive Black Holes in Galactic Nuclei: Past, Present and Future Research," *Space Science Reviews*, Volume 116, Issue 3–4 (2005), pp. 523–624; D. Richstone et al., "Supermassive Black Holes and the Evolution of Galaxies," *Nature* 395 (1 October 1998): A14–A19; Julianne J. Dalcanton, "18 years of Science with the Hubble Space Telescope," *Nature* 457 (1 January 2009): 45; Mario Livio, "Hubble's Top Seven Science Discoveries," *Astronomy* (April 2015): 32.
- 25 Robert E. Williams, oral history interview by author, 21 May 2015, part 1, pp. 6–9.
- 26 For early results of the Medium Deep Survey, see R. E. Griffiths et al., "The Hubble Space Telescope Medium Deep Survey with the Wide Field and Planetary Camera. 1: Methodology and Results on the Field Near 3c 273," *The Astrophysical Journal* 437 (10 December 1994): 67–82; STScI, "Hubble Space Telescope Sky Survey Reveals Embryonic Galaxies," news release STScI-1992-19, 29 June 1992. See also STScI, "Hubble Completes Eight-Year Effort to Measure Expanding Universe," news release STScI-1999-19, 25 May 1999.
- 27 John N. Bahcall, Puragra Guhathakurta, and Donald P. Schneider, "What the Longest Exposures from the Hubble Space Telescope Will Reveal," *Science* 248 (13 April 1990): 178–183.
- 28 Kirshner, *Extravagant Universe*, p. 243.
- 29 STScI, "Hubble Identifies Primeval Galaxies, Uncovers New Clues to the Universe's Evolution," news release STScI-1994-52, 6 December 1994; Williams OHI, part 1, 7; Williams, Okamura, and Suzuki, "Round Table Talk: Conversation with Robert Williams," p. 26.
- 30 Williams OHI, part 1, p. 8; Richard Ellis, "The Hubble Deep Field: Introduction and Motivation," in *The Hubble Deep Field*, M. Livio, S. M. Fall, and P. Madeu, eds., (New York: Cambridge University Press, 1998), p. 27; Williams, Okamura, and Suzuki, "Round Table Talk: Conversation with Robert Williams," pp. 23–26.
- 31 Robert E. Williams et al., "The Hubble Deep Field: Observations, Data Reduction, and Galaxy Photometry," *The Astronomical Journal* 112, no. 4 (October 1996): 1335–1389; Williams OHI; STScI, "Hubble's Deepest View of the Universe Unveils Bewildering Galaxies across Billions of Years," news release STScI-1996-01, 15 January 1996.
- 32 Williams OHI, part 1, 9.
- 33 Dalcanton, "18 Years of Science," 48.
- 34 Robert E. Williams, oral history interview, 21 May 2015, part 2.
- 35 Dalcanton, "18 Years of Science," 41–50; Kirshner, *Extravagant Universe*, pp. 246–249; Panek, *4% Universe*, pp. 176–180.
- 36 European Space Agency Hubble News, "The Hubble Deep Fields," http://www.spacetelescope.org/science/deep_fields/ (accessed 4 June 2017); STScI, "The Universe 'Down Under' is the Latest Target for Hubble's Latest Deep-View," news release STScI-1998-41, 3 November 1998; STScI, "Hubble Approaches the Final Frontier: The Dawn of Galaxies," news release STScI-2004-28, 23 September 2004; STScI, "Hubble Goes to the eXtreme to Assemble Farthest Ever View of the Universe," news release STScI-2012-37, 25 September 2012; Steven V. W. Beckwith et al., "The Hubble Ultra Deep Field," *The Astronomical Journal* 132 (2006): 1729–1755.
- 37 Livio, "Hubble's Legacy."

- 38 Dalcanton, "18 Years of Science," 46.
- 39 Space Telescope Science Institute, "Hubble Deep Fields Initiative 2012 Science Working Group Report" (Baltimore, MD: STScI, 2012); "The Hubble Frontier Fields," from *Hubble 24: Science Year in Review* (Greenbelt, MD: NASA Goddard Space Flight Center, 2014) pp. 77–92; Brandon Lawton, "Sharing the NASA Frontier Fields Story" (8 March 2017), <https://frontierfields.org/2017/03/08/sharing-the-nasa-frontier-fields-story/> (accessed 4 June 2017).
- 40 "Hubble's Multi-Cycle Treasury Programs," *Hubble 21: Science Year in Review* (Greenbelt, MD: NASA Goddard Space Flight Center, 2014), pp. 85–101; Faber OHI, pp. 28–30; Julianne Dalcanton, oral history interview by author, 16 February 2017. See also Hubble Second Decade Committee, *The Hubble Treasury Program: A New Class of Hubble Observations* (Baltimore, MD: STScI, December 2000).
- 41 See John R. Spencer and Jacqueline Mitton, eds., *The Great Comet Crash: The Collision of Comet Shoemaker-Levy 9 and Jupiter* (Cambridge: Cambridge University Press, 1995).
- 42 Spencer and Mitton, *The Great Comet Crash*, pp. 56, 102; Villard OHI; Malcolm W. Browne, "Comet Crashes Into Jupiter in Dazzling, Galactic Show," *New York Times* (17 July 1994): A12; Heidi Hammel, oral history interview by author, part one, 18 May 2017, pp. 5–9. Like many other people, the author viewed the marks left by the fragments on Jupiter through an 8-inch reflector telescope on his back deck.
- 43 Hammel OHI, part 1, 13.
- 44 Carol Collins Peterson and John C. Brandt, *Hubble Vision: Further Adventures with the Hubble Space Telescope* (Cambridge, UK: Cambridge University Press, 1998), pp. 41–51; NASA, *Highlights of Hubble's Exploration of the Universe* (Baltimore, MD: Goddard Space Flight Center, NP-2016-9-491-GSFC, 2016); STScI and NASA, *A Quarter-Century of Discovery with the Hubble Telescope* (STScI and NASA Goddard Space Flight Center, 2015); STScI, "UA Scientist & Team Discover Surface Features Cover Titan," news release STScI-1994-55, 8 November 1994.
- 45 Heidi Hammel, oral history interview by author, part 2, 18 May 2017, pp. 1–8.
- 46 Peterson and Brandt, *Hubble Vision*, pp. 51–61; Amy Simon, *Results from the Outer Planet Atmospheres Legacy (OPAL) Program*, PowerPoint (Greenbelt, MD: Goddard Space Flight Center, 2016).
- 47 Peterson and Brandt, *Hubble Vision*, pp. 61–63; STScI, "NASA's Hubble Telescope Finds Potential Kuiper Belt Targets for New Horizons Pluto Mission," news release STScI-2014-47, 15 October 2014; NASA Headquarters news release, "NASA's New Horizons Team Selects Potential Kuiper Belt Flyby Target," 28 August 2015; J. J. Kavelaars, "Exploring a New World at the End of the Solar System: The Ultima Thule Flyby," presentation, Royal B.C. Museum, 27 April 2019; NASA news release, "Far, Far Away in the Sky: New Horizons Kuiper Belt Flyby Object Officially Named 'Arrokoth,'" 12 November 2019. The name comes from a term for "sky" in the Powhatan/Algonquian language. At the time of the flyby, the object was informally known as Ultima Thule.
- 48 STScI, "Scientists Track 'Perfect Storm' on Mars," news release STScI-2001-31, 11 October 2001; "Hubble Finds Cloudy, Cold Weather Conditions for Mars-Bound Spacecraft," news release STScI-1997-15, 20 May 1997; "Hubble Monitors Weather on Neighboring

- Planets,” news release STScI-1995-16, 21 March 1995; “NASA’s Hubble Looks For Possible Moon Resources,” news release STScI-2005-29, 19 October 2005.
- 49 STScI and NASA, *Quarter-Century of Discovery*, p. 9; STScI, “Hubble Identifies a Long-Sought Population of Comets Beyond Neptune,” news release STScI-1995-26, 14 June 1995; STScI, “NASA’s Hubble Observes the Farthest Active Inbound Comet Yet Seen,” news release STScI-2017-40, 28 September 2017.
- 50 Hester OHI, pp. 27–32; STScI, “Embryonic Stars Emerge from Interstellar ‘Eggs,’” news release STScI-1995-44, 2 November 1995; David DeVorkin and Robert W. Smith, *The Hubble Cosmos: 25 Years of New Vistas in Space* (Washington, DC: National Geographic Society, 2015), pp. 90–95; STScI, “Hubble Movies Provide Unprecedented View of Supersonic Jets from Young Stars,” news release STScI-2011-20, 31 August 2011.
- 51 Mario Livio, “Hubble’s Top 10,” *Scientific American* (July 2006): 47–48.
- 52 Anton, *Bold Science*, pp. 55–77.
- 53 STScI, “Telescopes Team Up to Find Distant Uranus-Sized Planet Through Microlensing,” news release STScI-2015-27, 30 July 2015; “Hubble Finds Hidden Exoplanet in Archival Data,” news release STScI-2009-15, 1 April 2009; “Astronomers Find Elusive Planets in Decade-Old Hubble Data,” news release STScI-2011-29, 6 October 2011.
- 54 DeVorkin and Smith, *Hubble Cosmos*, pp. 177–181; STScI, “Suspected Protoplanet May Really Be a Distant Star,” news release STScI-2000-13, 6 April 2000; Ray Villard OHI, 4 November 2016, pp. 15–18; STScI, “Exoplanet Apparently Disappears in Hubble Observations,” news release STScI-PR20-09, 20 April 2020.
- 55 STScI, “Hubble Makes First Direct Measurements of Atmosphere on World Around another Star,” news release STScI-2001-38, 27 November 2001; “Highlights of Hubble’s Exploration,” p. 3.
- 56 Robert W. Smith, “HST in Orbit: Ten Years and Counting,” *Sky & Telescope* (April 2000): 28–34. The emphasis is Smith’s.
- 57 Mario Livio, “Hubble’s Legacy.”



CHAPTER SEVEN

The Fall and Rise of Hubble's Last Servicing Mission

▲ The WFC3 instrument aboard the HST snapped this image of the planetary nebula NGC 6302, more popularly called the Bug Nebula or the Butterfly Nebula. (NASA/ESA/Hubble SM4 ERO Team: heic0910h)

When HST Servicing Mission 3B ended with Columbia's touchdown at the Kennedy Space Center in the predawn darkness of 12 March 2002, Sean O'Keefe greeted the crew of the first Shuttle mission flown since he had become Administrator of NASA a few months earlier. O'Keefe had inherited a Shuttle Program that was to all appearances running smoothly, but his three years in NASA's top job would be remembered for a controversial decision he made about the upcoming servicing mission. As the Shuttle returned that morning, most HST engineers and scientists were already turning their attention to preparations for Servicing Mission 4, which promised the biggest set of improvements yet to HST's imaging and spectrographic capabilities. SM4 would ultimately redeem its promise, but the path to that success would be much longer and windier than anyone that day could have expected. Along the way, scientists and large numbers of the general public would show the high regard they felt for HST. This chapter will tell the story of Servicing Mission 4, which gave HST a new lease on life that has extended well past a decade.

POST-HUBBLE PREPARATIONS

The work that led to SM4 began shortly before the launch of the first servicing mission in 1993 that restored Hubble's vision. At the time, Hubble's mission was due to last 15 years until 2005, and no decision had yet been made about what would follow HST. The Association of Universities for Research in Astronomy, the parent body of STScI, set up an 18-member "HST and Beyond" committee in 1993 with NASA's support. The committee, chaired by Alan Dressler of

the Carnegie Observatories, was charged with recommending a path forward from HST to a successor observatory in space. When the committee reported in May 1996, it called for continuing HST operations beyond 2005, and for development of a new space observatory with an aperture of at least 4 meters to conduct imaging and spectroscopy in the infrared and near infrared.¹

The idea for a giant infrared space telescope to follow HST was not new in 1996. It followed on the push for more space telescopes operating in the infrared that led to the installation of NICMOS on HST in 1997, which was discussed in chapter five. In the 1980s, a new generation of larger ground-based telescopes came into service, and astronomers at STScI took note of this fact and began drawing up proposals for a larger space telescope to follow HST. This idea drew wider notice in a 1988 report from the Space Science Board of the National Academy of Science. Among its recommendations for the period from 1995 to 2015 was an 8- to 16-meter space telescope with cooling for “maximum infrared performance” capable of delivering sharper images from deeper in the universe.² A larger infrared instrument would be ideal to build on HST’s work of studying the formation of stars, galaxies and planetary systems very early in the history of the universe. Because early galaxies are moving away rapidly from us and thus are redshifted, a telescope operating in the infrared is required to see them. Even with instruments like NICMOS, HST does not operate far enough into the infrared to see these primeval galaxies, and the Spitzer Space Telescope, NASA’s Great Observatory that operated in the infrared, did not have a large enough aperture to study early galaxies in detail. In September 1989, STScI hosted a workshop on what was already known as the Next Generation Space Telescope (NGST), where participants proposed placing a 16-meter telescope on the Moon or a 10-meter telescope in a high orbit around Earth. Workshop participants hoped that NGST would be operating well before the expected end of HST operations.³ The 1991 decadal survey committee of the National Research Council led by John Bahcall discussed the major advances and growing interest in infrared astronomy, going so far as to proclaim the 1990s the “Decade of the Infrared,” and supporting work on what became the Spitzer Space Telescope. But the committee did not call for a larger telescope to succeed HST, possibly because of HST’s highly publicized spherical aberration problem, which had yet to be solved. Despite this setback for NGST, discussions and technical research into the idea continued in the early 1990s.⁴

By 1996 when the Dressler report recommended a minimum 4-meter NGST in deep space, three independent teams from NASA Goddard, Lockheed Martin, and TRW, Inc. found the concept feasible. As studies continued in

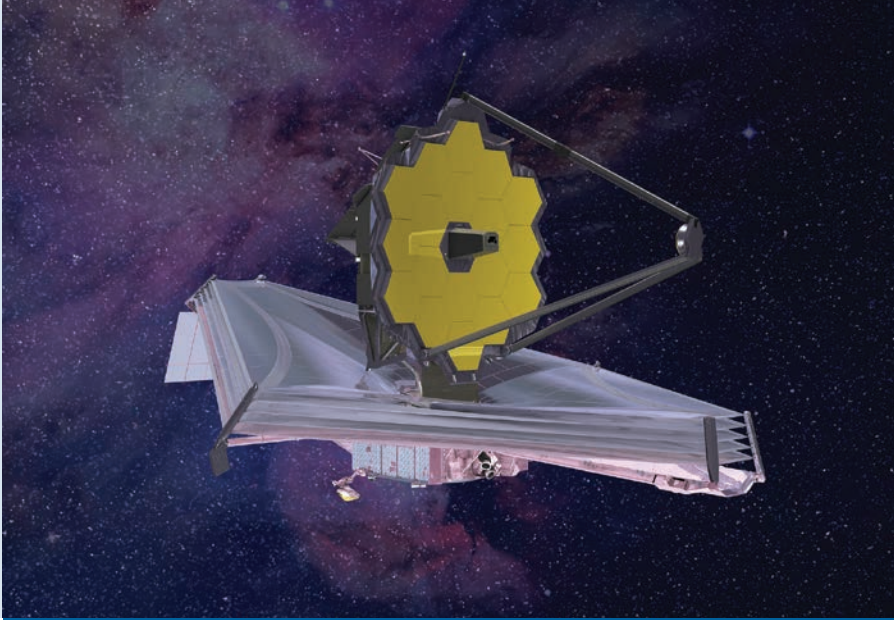

▲ An artist's conception of the James Webb Space Telescope from 2015. (Northrop Grumman)

1998, NASA gave STScI responsibility for NGST's science operations. By 2002, NGST had been named the James Webb Space Telescope (JWST) after James E. Webb, who led NASA from 1961 to 1968 and is credited with the success of Apollo. That year, NASA named TRW, which in 2002 became Northrop Grumman Space Technology, as prime contractor for JWST. Ball Aerospace was given responsibility for the telescope's optical element. Both the ESA and the Canadian Space Agency (CSA) became full participants in the JWST program, with each providing a scientific instrument, other equipment in the telescope, and scientific staff at STScI. Construction of the James Webb Space Telescope and its 6.5-meter segmented mirror began in 2004, and NASA and the ESA agreed in 2005 that it would be launched on an Ariane 5 rocket supplied by the ESA.⁵ At this writing, JWST is undergoing testing with a launch expected in 2021.

AN EXTENSION FOR HST

NASA endorsed the Dressler report's call for HST to continue operating beyond 2005. Because of its choice of a large infrared telescope to follow HST, the Dressler committee acknowledged that there would be no other large observatory with ultraviolet capability for some time other than HST. Its report recommended that Hubble, equipped with the Space Telescope Imaging

Spectrograph, the Advanced Camera for Surveys (ACS), and even newer instruments that could be installed in SM4, “should have excellent, unprecedented UV capability for imaging and spectroscopy, capabilities completely unavailable from the ground or from space with such a large collecting area.” The report also noted that HST has a valuable ability “to respond to transient or unforeseen developments,” and it suggested that HST could operate in “a much more economical style of operations beyond 2005” without the expense of further servicing missions.⁶

Within months of the Dressler report, NASA’s Office of Space Science (OSS) issued an Announcement of Opportunity in December 1996 for “one or two instrument proposals” to be considered for SM4, which was then planned for 2002. NASA set a tight budget for the instrument or instruments selected for this opportunity.⁷ The announcement drew many proposals, and in August 1997, the OSS announced that it had selected the Cosmic Origins Spectrograph (COS), proposed by a team led by James C. Green of the University of Colorado in Boulder, for installation on HST in SM4. COS would take the place of the COSTAR instrument that had restored the vision of three other HST instruments when spherical aberration was discovered. Now that all three instruments had been replaced with newer instruments designed to compensate for the problem, COSTAR was no longer needed. NASA HST Senior Project Scientist David Leckrone described COS as being 15 to 20 times more sensitive in the far ultraviolet than STIS. HST management chose Ball Aerospace to build COS using some structural elements from the Goddard High Resolution Spectrograph (GHRS), which had been returned from orbit.⁸ COS was judged to be far superior to any of the competing proposals, but the peer review team that chose COS suggested that it could be upgraded for even better science at low cost. The COS instrument team responded by recommending a set of upgrades to COS including a near ultraviolet channel using a flight spare Multi-Anode Microchannel Array (MAMA) detector originally built for STIS that would complement COS’s far ultraviolet capabilities. The use of recycled and spare instrument parts was part of promoting what Leckrone called “low-cost means to back up the primary instruments for UV-Optical imaging and UV spectroscopy, so that significant failures in one instrument will not leave HST blind or without the diagnostic tools of spectroscopy.” Another budget pressure affecting HST was NASA’s effort to create room in the budget to build JWST.⁹

After the peer review team chose only COS for installation on SM4, Leckrone and NASA Associate Administrator for Space Science Ed Weiler decided that there was still money for another instrument, and suggested building another imaging instrument to replace WFPC2. Personnel from the HST project, JPL,

Ball, STScI, and ESA studied the idea and proposed Wide Field Camera 3, which would be built using parts from the returned WF/PC instrument and flight spare components from ACS and WFPC2 to keep costs down, including a flight spare CCD from the ACS program. Instead of being sponsored by a traditional scientific team with a Principal Investigator, WFC3 would be a “facility instrument” developed by an HST project team supervised by the WFC3 Science Oversight Committee.¹⁰ WFC3 was originally visualized as a “clone” of WFPC2, but members of the astronomical community pushed for a more capable instrument with an additional detector operating in the near infrared. The HST Second Decade Committee, formed in 1998 to devise a blueprint for HST’s second decade of operations, formally recommended the infrared capability. In spite of Weiler questioning the need for an infrared detector given its cost and complexity, WFC3 became a panchromatic camera that operated in ultraviolet, visible, and infrared wavelengths. Leckrone and others give credit to Edward Cheng, HST Project Scientist for Development at Goddard, for using his knowledge of digital devices and his contacts with the electronics industry to equip WFC3 with its cutting edge infrared detector. WFC3’s ultraviolet-visible channel is far more powerful than the ultraviolet imaging channel on ACS, and its detectors with a wider field of view, sensitivity, and low noise represent a 15- to 20-time enhancement in capability over NICMOS.¹¹ Funding for COS, including upgrades, came from \$43.5 million budgeted for the instrument, and money for WFC3 came from HST science program reserve funds.

In 1997, the NASA Office of Space Sciences authorized the HST Project to budget on the assumption that its mission would continue beyond 2005, providing the final endorsement of the Dressler report’s recommendation. Leckrone advised astronomers that a “mission to bring HST back to Earth in 2010 is sketched into our long-term plan.” That coincided with a period of high solar activity, which would lower the orbit of HST, which was then projected to be near the end of its operational life eight years after the planned 2002 date for SM4, the final servicing mission.¹² Since NGST was then planned for launch in 2007, he expressed the hope for coordinated operations involving it and HST. Leckrone wrote that SM4: “will be the last in-orbit maintenance of HST. We will then be operating in a low-cost mode.”¹³ Four years before it was originally due to fly in 2002, Servicing Mission 4 was established as a major event in the Hubble program. Leckrone said these plans were designed to meet the goals of insuring that HST would “produce top-rank science until 2010” and maintain a flow of data “that continues to be both scientifically compelling and inspirational to the general public” at low cost.¹⁴ With the exception of the 2002 launch date, NASA’s plans for SM4 remained intact through the changes that

converted the third servicing mission into two missions, SM3A and SM3B.

SEAN O'KEEFE

When O'Keefe welcomed the crew of SM3B back to Earth in March 2002, he was 46 and had already established himself as a strong financial administrator in the Pentagon under President George H. W. Bush, serving as Comptroller and Chief Financial Officer at the Department of Defense and then as Secretary of the Navy. When President George W. Bush took office in 2001, he appointed O'Keefe Deputy Director of the Office of Management and Budget (OMB), where one of the agencies whose budget he supervised was NASA. After Daniel Goldin stepped down as NASA Administrator late

that year, the president tapped O'Keefe to head up the Agency with a mandate to deal with the budget problems in the International Space Station Program that he was already familiar with from his service at OMB.¹⁵

Mindful of the Challenger disaster years before and his own experiences in the Pentagon with plans and protocols for mishaps, O'Keefe made sure upon becoming Administrator that NASA updated its preparations for another disaster. By 2002, every Shuttle flight was dedicated to building and servicing the International Space Station, with two exceptions: the 16-day STS-107 science mission, featuring a suite of medical, material, and remote sensing experiments inside a Spacehab double module installed in Columbia's cargo bay, and HST Servicing Mission 4, also on Columbia, by then slated for 2004. O'Keefe learned that these "stand-alone" Shuttle missions involved a higher degree of danger than missions to the ISS. HST's orbit is inclined at 28.5 degrees to the equator and the Space Station at 51.6 degrees. Since changing orbital inclinations requires massive amounts of fuel, a crew on an HST servicing mission could not use the Station as a safe haven if their Shuttle could not safely return to Earth.¹⁶

A DISASTROUS RETURN

Four Shuttle missions flew in 2002 to the ISS after SM3B's return, and the oft-delayed STS-107 Spacehab mission finally launched on 16 January 2003.¹⁷

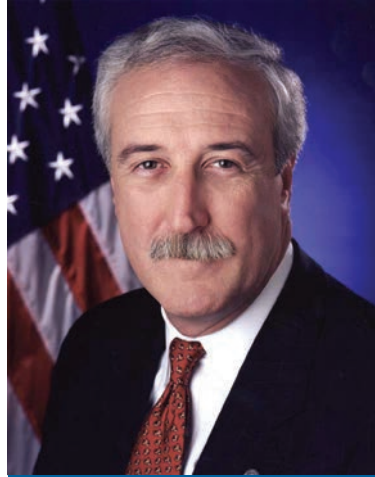

▲ Sean O'Keefe was NASA Administrator from 21 December 2001 to 11 February 2005. (NASA/Bill Ingalls)

Aside from the fact that its crew included Israel's first astronaut, STS-107 got little public notice during its time in space. Science missions like STS-107 had once been a staple of the Shuttle Program, but NASA was shifting scientific research to the ISS. STS-107 was seen as a transitional mission preparing astronauts and researchers for routine scientific work on board the Space Station.¹⁸ Tragically, Columbia broke up as it re-entered Earth's atmosphere at the end of its mission on 1 February. A piece of foam insulation that had struck its wing at high speed during launch created a breach that compromised Columbia's thermal protection system when it faced the heat of re-entry. Debris and the bodies of the seven astronauts were strewn over a wide area of east Texas.¹⁹

That morning O'Keefe stood alongside the Shuttle landing facility at KSC, awaiting Columbia, as he had done the year before with SM3B. When he got word that communications and radar contact had been lost with the Shuttle over Texas, O'Keefe contacted President Bush and other officials, then met with the families to offer his condolences. Videos of the descending debris soon



▲ The seven STS-107 crew members pose for their crew portrait prior to their launch in January 2003 on Columbia. Seated in front are astronauts (left to right) Rick D. Husband, mission commander; Kalpana Chawla, mission specialist; and William C. McCool, pilot. Standing are (left to right) astronauts David M. Brown, Laurel B. Clark, and Michael P. Anderson, all mission specialists; and Ilan Ramon, payload specialist representing the Israeli Space Agency. (NASA: STS107-S-002)

appeared on television. The disaster marked the second loss of a Shuttle and its crew, raising questions about the future of the Shuttle Program. The Challenger accident in 1986 grounded the Shuttle fleet for 32 months and caused NASA to remove defense, commercial, and high-risk payloads from the Shuttle. When Weiler turned on his television that Saturday morning and learned of the destruction of Columbia, he immediately began to worry about the upcoming Hubble servicing mission.²⁰

NASA suspended all Shuttle flights while an investigation took place. The report of the 13-member Columbia Accident Investigation Board (CAIB), issued seven months later, found that the causes of the disaster went well beyond the fact that a piece of foam insulation from the Shuttle's external tank had breached Columbia's thermal protection system during launch. The thermal protection system, it turned out, had suffered repeated breaches during many launches throughout the Shuttle Program. The loss of Columbia, in the view of the board, "was related in some degree to NASA's budgets, history, and program culture, as well as to the politics, compromises, and changing priorities of the democratic process."²¹ The board's 29 recommendations included a call to establish inspection procedures for damage to the Shuttle thermal protection system once each Shuttle reached orbit. Astronauts could seek shelter on the ISS and await the launch of rescue vehicles if the Shuttle's thermal protection system was breached. For Shuttle missions not involving the ISS, which meant only SM4, the CAIB report said NASA should "develop a comprehensive autonomous (independent of station) inspection and repair capability to cover the widest possible range of damage scenarios."²²

Looking beyond immediate safety issues to the future of the Shuttle Program, the CAIB recommended that if Shuttles were to continue flying beyond 2010, the three remaining Shuttle orbiters and all their systems, subsystems, and components should be recertified for flight. O'Keefe and officials at the White House began work that fall to develop a new policy that would address the future of the Space Shuttle Program.²³

A SIXTH SERVICING MISSION?

The board's vague language in relation to Servicing Mission 4 caused few people involved with Hubble to suspect that SM4 might never fly. Indeed, language in Congressional appropriations legislation passed in February 2003 shortly after the Columbia disaster directed NASA to form a panel of seven astronomers to study a sixth servicing mission, Servicing Mission 5. The panel, headed by David C. Black, President of the Universities Space Research Association, found in its April 2003 report that if SM4 was successful, HST "would continue



▲ Edward Weiler, who held several high-level positions at NASA during the time of HST, photographed in 2018. (NASA/W. Hrybyk)

to provide the highest quality scientific return at and beyond the time of a proposed SM5.”²⁴ Congress had asked if it would be worth flying SM5 without new instruments to install on HST, or with two new instruments that had been under study in 2002, a very wide field imager and an advanced coronagraph, that could search for Jupiter-sized planets around other stars. The appropriations language stated that funding for such missions would have to come from NASA’s Origins Program, which funded a number of other scientific spacecraft and telescopes. The panel questioned whether the proposed instruments would be ready in time for a servicing mission in 2007 or 2008, and declined to suggest whether Origins Program funds should be diverted to a servicing mission with or without the new instruments.²⁵

In the summer of 2003, NASA’s Office of Space Science convened another panel of six astronomers headed by John Bahcall to consider the transition from HST to the James Webb Space Telescope. When its report was submitted to NASA in August, the panel recommended as its top preferred option two servicing missions: SM4 in about 2005 and a possible SM5 in about 2010. The fate of this additional mission would be decided by a competition amongst scientists to determine if a new HST instrument could produce better science within budgetary and operational constraints than other space astrophysics proposals

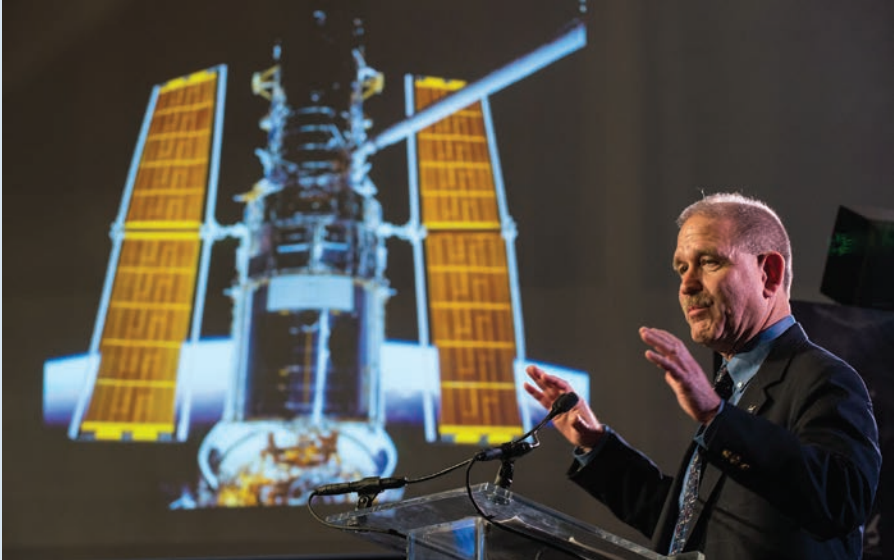

▲ John Grunsfeld, who flew in three HST servicing missions and also served as Associate Administrator for the Science Mission Directorate, photographed in 2018. (NASA/Joel Kowsky)

not involving HST. The fact that such an option was given top priority meant that many astronomers were still thinking about SM5, even when SM4 was at risk due to the Shuttle's problems. The second option involved flying only SM4, which would involve installing COS and WFC3, repairing HST systems, and "attaching a device...that would make robotic de-orbiting easier," and the third option was no servicing mission at all. The report suggested that if no further servicing missions were authorized, the two new HST instruments, WFC3 and COS, could instead be flown in a "stand-alone mission" involving a "2-meter class telescope" in geosynchronous orbit before JWST was launched.²⁶

The panel also heard from astronaut John M. Grunsfeld, who said that he and his fellow astronauts were willing to risk their lives to service HST for more scientific work, but not to retrieve Hubble so it could be placed in a museum. The panel therefore recommended that the Shuttle be used to attach a propulsion module that could extend HST's lifetime on orbit and then enable the end of its mission, although a robotic installation of such a module should also be considered. STScI and astronomers from elsewhere called for overlapping operations involving both HST and JWST to obtain optical and ultraviolet images from HST images in the infrared from JWST. While JWST was slated at the time for launch in 2011, the panel concluded that the JWST launch date "might be delayed substantially beyond 2011," which is what happened. Possible delays to JWST and the desire for overlapping operations involving the two telescopes

pointed the panel to the need for SM5.²⁷ The report generated controversy that fell amongst astronomers, who feared that the money spent for an SM5 mission or a robotic flight to attach a de-orbit module to HST would come at the expense of other space science missions.²⁸ That fall, NASA Headquarters Astronomy and Physics Division Director Anne L. Kinney warned that missions in NASA's Explorer and Discovery programs could be halted for roughly five years for budget reasons if Servicing Mission 5 was flown, something that would go against recent decadal studies of astronomy and astrophysics recommendations for scientific diversity in flight programs. Kinney called for completion of SM4, followed by de-orbiting of HST "after useful science ceases."²⁹ Inside NASA, the prospect of SM5 got little thought because the focus was turning to SM4 as the implications of the Shuttle's problems became clear.

CANCELLATION

Weiler, the NASA Associate Administrator with responsibility for HST, recalled that he became more worried about the status of SM4 when he saw the Shuttle safety measures the Columbia Accident Investigation Board report called for when it reported in August 2003. To Weiler, the Bahcall panel's public support for SM5 suggested that many astronomers were taking SM4 for granted. In October, Weiler submitted a budget to NASA budget officials that included SM4, paid for by cuts to other parts of NASA's space science budget. "We will do this mission and we will pay for it even if it means taking it out of our own hides," Weiler recalled of his plans at the time. On 7 November, Weiler briefed O'Keefe and other NASA leaders on various options, ranging from no servicing mission at all to flying SM4, at dates as early as June 2005 and as late as 2008. The direction of the discussion did not suggest to him that SM4 was in trouble. "I left that meeting...feeling like we were on the road to SM4."³⁰

Everyone at NASA knew from the experience of the Challenger disaster that returning the Shuttles to flight would take at least two years. They also knew that when flights resumed, the ISS, still in the midst of construction, would get top priority for Shuttle missions. Any servicing missions to Hubble could only be delayed so long because HST had only a limited lifetime without servicing. O'Keefe had authorized a Return to Flight Task Group and other preparations to return the remaining three Shuttle orbiters, Discovery, Atlantis, and Endeavour, to flight status even before the CAIB had completed its report. When O'Keefe saw the CAIB's recommendations at the end of August 2003, he began to think that it would be difficult to mount HST Servicing Mission 4 during HST's lifetime. The Shuttle's return-to-flight mission, which would go to the ISS, was slipping into 2005, and any Hubble servicing mission would take

place well after that time. O’Keefe later said, “by the late fall, early winter it was pretty apparent that our likelihood of accomplishing all those objectives [set by the board] were becoming more and more remote.”³¹ NASA Comptroller Steve Isakowitz noted that SM4 costs would increase with the delay, with the money coming out of other NASA space science programs at a time when JWST costs were growing. In O’Keefe’s mind, the question increasingly was, would HST still be operating by the time the servicing mission could fly?³²

Over the Thanksgiving weekend, O’Keefe worked on NASA’s 2005 budget submission with Isakowitz and others. O’Keefe called the working session a “prompting event,” a time to make a decision. Based on his growing conviction that the servicing mission could not be carried off as the CAIB had recommended, O’Keefe effectively cancelled it by not including money for SM4 preparations in the 2005 budget.³³ By the beginning of December, O’Keefe recalled, money for SM4 had been removed from the budget NASA sent to the White House, and the decision to cancel SM4 was secret pending presidential approval of the budget.³⁴

Weiler learned that SM4 was out of the budget at a meeting of NASA Associate Administrators with O’Keefe and Isakowitz on 2 December. He said, “I was very shocked. I was surprised that people had the guts to make such a tough decision.” On 19 December, O’Keefe told President Bush about the cancellation of SM4, and Bush agreed with the decision since it would comply with the CAIB recommendations. O’Keefe was meeting the President that day to discuss Bush’s Vision for Space Exploration, which would be announced less than a month later in January.³⁵

John Grunsfeld had turned to preparatory work for SM4 following his return from the SM3B mission in 2002 up to the time he accepted O’Keefe’s appointment in September 2003 as NASA Chief Scientist at Headquarters. Grunsfeld saw that job as having a limited term, and he hoped to join the crew of SM4 when it was named. One day in late November, Grunsfeld asked Isakowitz about the status of SM4, but misunderstood the Comptroller’s shake of the head and assumed the mission was still going ahead. On 6 January 2004, Grunsfeld was in Atlanta attending a meeting of the American Astronomical Society when he was summoned back to Washington for a meeting of top NASA officials including O’Keefe and Weiler. There he was shocked to learn that O’Keefe was cancelling the mission. Grunsfeld soon discovered that there was no formal safety analysis of SM4 to back up the decision, and he realized from the Administrator’s own words that his decision to cancel was a “gut call.”³⁶ Grunsfeld considered leaving NASA over the issue. But when he called his friend and confidant John Bahcall to discuss the situation, Bahcall told him that

while everyone in the astronomy community would respect him if he left, “you’ll be able to do nothing to save Hubble.”³⁷ Grunsfeld took Bahcall’s advice to stay. Thus fortified, Grunsfeld began the unenviable task that Weiler had given him of organizing the announcement of the cancellation. Grunsfeld planned the announcement for 28 January, well after President Bush unveiled his new Vision for Space Exploration but before the new NASA budget was published.³⁸

On 14 January 2004, Bush visited NASA Headquarters and before a full house in the main floor auditorium, outlined his plans for the future of American space exploration, including completion of the ISS and retirement of the Shuttle in 2010, a new Crew Exploration Vehicle to replace the Space Shuttle, and a return to the Moon by astronauts no later than 2020.³⁹ Although nothing was said about HST, the next day’s *Washington Post* story about Bush’s announcement contained the following paragraph: “There may also be slowed growth in the NASA space science budget, sources said, and a ‘refocusing’ of activities within the agency to support the central theme of returning to the Moon. There will be no further servicing missions to the Hubble Space Telescope. Though there is rampant speculation about closing NASA facilities and axing programs, there were few specifics.”⁴⁰ The leak apparently originated with a White House staffer who spoke about SM4 in a briefing to a congressional committee. In the minds of many people, the *Washington Post* story appeared to tie the controversial SM4 cancellation to the President’s new space policy, something that could threaten congressional support for the policy.⁴¹

O’Keefe, surprised by the *Washington Post* revelation, called Senator Barbara Mikulski of Maryland—where GSFC and the STScI are based—to brief her on the SM4 decision, and with help from Weiler and Grunsfeld, organized a meeting for the next day at Goddard to explain the cancellation to those who worked on Hubble. O’Keefe spoke at the meeting for nearly 45 minutes without notes, stating that the decision was his alone. The Administrator and others also discussed ideas to prolong HST’s lifetime without a servicing mission. Weiler and Grunsfeld spoke in support of the Administrator’s decision in front of the unhappy crowd. Word quickly spread online, and Grunsfeld and Steven Beckwith, the director of the Space Telescope Science Institute, spoke to the media, with Grunsfeld referring to a “sad day” and Beckwith pronouncing astronomers as “devastated” by the news.⁴²

PROLONGED CONTROVERSY

O’Keefe’s decision to cancel SM4 was immediately the subject of public controversy, and many people involved with HST remained angry about the decision years after it was made. Many Hubble supporters agreed with Weiler and

Beckwith when they stated in private that O’Keefe was not an engineer or scientist, and questioned his qualifications to make such a judgment. Beckwith and others seized on the lack of a formal risk analysis for SM4 to question the Administrator’s safety concerns. O’Keefe’s successor Michael Griffin suggested years later that ISS program officials opposed SM4 because it would delay construction of the Space Station, which was dependent on timely Shuttle missions, and he also said astronomers concerned about funding for non-HST programs did not support spending on SM4. Critics of O’Keefe’s SM4 decision suggested that he was poorly advised, but O’Keefe replied that he had no reason to question the advice he received from NASA officials on SM4.⁴³

O’Keefe was acutely aware of the controversy caused by his cancellation of SM4, and shortly after he made that decision he asked NASA Chief Historian Steven J. Dick to report on how and why the decision was made, using relevant documents and oral history interviews with top NASA officials, including O’Keefe himself. The interviews and documents collected by Dick have informed this account of the decision, although the author interviewed most of the main participants in the controversy on his own.⁴⁴ “Humans had a proven record of servicing [HST] with the Space Shuttle, but the Space Shuttle might not be able to make it in time,” Dick wrote late in 2004. “At the core of the matter was an assessment of the relative risk of a Shuttle HST mission compared with a Shuttle ISS mission.”⁴⁵ Dick discussed issues related to the SM4 controversy that high-technology agencies like NASA often face, including whether American society in general and NASA in particular had become highly averse to risk in the time of the SM4 cancellation. Dick added that the SM4 cancellation decision also involved communication issues, given that many members of the media and the public believed that SM4 was cancelled to save money when the evidence showed that this was not the reason. The accidental release of the cancellation decision at nearly the same time as President Bush announced his Vision for Space Exploration caused many to believe that the two events were related when they were not.⁴⁶

In explaining his decision years later, O’Keefe noted that HST in 2004 was close to the end of its planned 15-year lifetime. He emphasized that the CAIB report and other knowledgeable people questioned NASA’s commitment to safety, making his response to the CAIB recommendations not only a matter of safety but of credibility for the whole Agency.⁴⁷ O’Keefe stressed that he had committed to implement the recommendations of the CAIB report, saying, “[W]e needed to demonstrate that anything that we could possibly anticipate, diagnose, see as an anomaly, or witness as any variation of what is an appropriate standard, be not only explained, but corrected.”⁴⁸ In the case of SM4, O’Keefe

believed that he would have to make an exception to his commitment if the servicing mission were to reach Hubble before it was forecast to stop operating.⁴⁹

STRONG REACTIONS

Once he announced the cancellation of SM4, O'Keefe and everyone who had anything to do with HST had to deal with the reactions to that decision. In the weeks that followed, support for HST poured into the hubblesite.org website and to Beckwith, O'Keefe, and members of Congress. Some writers offered to contribute money to save Hubble, while others suggested that Hubble be moved to the International Space Station for repairs—an impossibility given their vastly different orbits—or that soft drink companies help pay for Hubble repairs in return for logo placement on Hubble images. Other Hubble supporters created a savethehubble.com website. O'Keefe admitted that his “e-mail system is clogged up every day.” Many of the e-mails were sharply critical of his decision, and the NASA Administrator later said he was surprised by the level of “personal animus” directed at him by Hubble advocates.⁵⁰ In February, two anonymous papers arguing in favor of SM4 circulated around NASA, and in March, NASA issued a paper explaining O'Keefe's cancellation decision.⁵¹

Encouraged by the public comments inside his inbox and the urgings of his associate director, Bruce Margon, Beckwith decided to fight for SM4, and started by answering all the e-mails he received supporting Hubble. While there were legal limits to what STScI employees could do in the political arena, they were not as constrained as NASA employees. Beckwith called on Bahcall, who faced no constraints and knew the ways of Congress from his work to get HST built in the first place. “He was instrumental in a lot of ways,” Beckwith said of Bahcall, who “[d]elivered a lot of things to politicians that I couldn't



▲ Steven Beckwith, third director of STScI. (STScI)



▲ Senator Barbara Mikulski (D-MD) speaking at NASA's Goddard Space Flight Center in 2016.
(NASA/Goddard/Rebecca Roth)

do.”⁵² Beckwith said HST supporters had three “silver bullets”: First was the idea shared by many people that the safety reason for the cancellation was a “red herring” unsupported by a formal risk analysis, second was the strength of the science coming from HST and the potential offered by the new instruments scheduled for SM4, and third was the support of Senator Barbara Mikulski, the ranking Democrat on the Senate subcommittee that oversees NASA, who kept money flowing to the team preparing for SM4.⁵³

Mikulski acted within days of the cancellation announcement, writing O’Keefe on 21 January to ask for “an independent panel of outside experts to fully review and assess all of the issues surrounding another Hubble servicing mission” and an assurance that all work on SM4 continue until Congress had time to consider the matter. Although O’Keefe declined the request for a panel at first, he eventually asked Admiral Harold Gehman, who chaired the Columbia Accident Investigation Board, to review his decision. On 5 March, Gehman responded that the board was “split on the merits of flying this mission,” and therefore further study was required. Six days later, at a hearing of a Senate subcommittee, O’Keefe agreed under pressure from Mikulski and subcommittee chair Senator Christopher Bond (R-MO) to have the National Research Council of the National Academy of Science (NAS), along with the Government Accountability Office (GAO), look into the costs, risks, and benefits of such a mission. Later that day, O’Keefe told reporters that he remained

strongly opposed to another Shuttle mission to Hubble. O'Keefe raised the idea of repairing HST with a robotic mission when he wrote the National Academy of Science, a notion that became part of the NAS's study.⁵⁴ Mikulski kept up pressure on O'Keefe by introducing a bipartisan Senate Resolution calling on NASA to continue preparations for SM4 while the NAS looked at the issue, and Representative Mark Udall (D-CO) introduced a similar resolution in the House of Representatives.⁵⁵ Texas Republican Senator Kay Bailey Hutchinson wrote to the President, calling on NASA to repair the telescope and enclosed a petition signed by 26 retired U.S. astronauts urging the President to reinstitute SM4.⁵⁶ Outright opposition was not the only reaction to the cancellation. "People began to think very creatively about how we could get the best science we could out of Hubble in whatever remaining time we had without being able to service it," said Jennifer Wiseman, who had just become HST Program Scientist at NASA Headquarters. She came to believe that this work contributed to the scientific support for restoring SM4.⁵⁷

ROBOTS TO THE RESCUE?

After the Columbia disaster, Frank Cepollina at Goddard "immediately started thinking about a robotic servicing mission" because he worried that SM4 was "on thin ice." In the recollection of HST Program Manager Preston Burch, Cepollina worked quietly with his team and even astronauts to begin preparations for a robotic mission to Hubble. "So finally when O'Keefe came out and challenged us to a Hubble robotic mission, we already had in place a lot of the ideas and concepts for doing such a mission."⁵⁸ Neither O'Keefe nor Ed Weiler believed in February that there was much chance of a successful robotic repair mission. But when NASA Goddard requested ideas for such a mission on 20 February, it got 26 responses from a variety of institutions and contractors, including robot proposals from the Johnson Space Center, the Canadian Space Agency, and the University of Maryland. Goddard experts produced a Mission Feasibility Study that called a robotic mission feasible but challenging. "It's looking a lot more promising than I would have told you a few weeks back," O'Keefe told a congressional hearing on April 21.⁵⁹ In a speech on 1 June to astronomers gathered in Denver at an AAS meeting, O'Keefe compared the work on robotic missions to the "can-do spirit that propelled the first Hubble servicing mission," and announced NASA would pursue the feasibility of robotic servicing by issuing a request for proposals for a robotic servicing mission to HST.⁶⁰

While the responses to the request for proposals for a robotic mission encouraged O'Keefe, the confirmation that he was hoping for from the National Academy did not materialize. The NAS had appointed a 21-member committee

headed by Louis J. Lanzerotti, a consultant with Bell Laboratories, and on 13 July, it issued an interim report. It urged “that NASA commit to a servicing mission to the Hubble Space Telescope that accomplishes the objectives of the originally planned SM4 mission, including both the replacement of the present instruments with the two instruments already developed for flight—the Wide Field Camera 3 and the Cosmic Origins Spectrograph—and the engineering objectives, such as gyroscope and battery replacements.” While the committee supported NASA’s work on robotic missions, it said NASA should take no actions that would preclude SM4.⁶¹ Its final report, issued 8 December, made the same recommendations even more strongly, armed with critical input on the possibility of a robotic mission from the Aerospace Corporation and NASA’s Independent Program Assessment Office. “The likelihood of successful development of the HST robotic servicing mission within the baseline 39-month schedule is remote.”⁶² Turning to the safety requirements for SM4 laid down by CAIB, the committee found such a mission “viable” with a second Shuttle ready for launch to rescue the SM4 crew.⁶³

O’Keefe did not react to the report, but five days later announced his resignation from NASA. His handwritten letter of resignation to the President made no reference to the decision on the Hubble servicing mission but spoke of his “commitment to family.”⁶⁴ Even before the letter had been sent, media reported that O’Keefe was being considered for the chancellorship at Louisiana State University, a job he subsequently accepted. While critics of his SM4 decision suggest it caused him to step down, O’Keefe has always asserted that his resignation was not related to HST. In considering O’Keefe’s challenges at NASA, it should be remembered that he dealt with larger issues such as returning the Shuttle to flight, promoting the President’s Vision for Space Exploration, and dealing with the financial problems dogging the ISS. O’Keefe later explained that LSU had sounded him out for the chancellorship in the summer of 2004, but he refused to consider the offer until after the 2004 presidential election in November, which saw Bush win reelection. LSU renewed the offer after the election, a time when many agency and department heads consider their positions, and O’Keefe accepted the offer.⁶⁵ In his study of O’Keefe’s time at NASA, political scientist W. Henry Lambricht wrote that O’Keefe’s hopes of becoming secretary of defense in Bush’s second term were dashed when Donald Rumsfeld decided to remain in the post. After only three years at NASA, O’Keefe was tired, and the attacks he sustained because of his cancellation of SM4 had cost him some of the congressional support he had hoped to use to advance the President’s Vision for Space Exploration. The outgoing Administrator remained in place until February, and his plans for HST remained unchanged.⁶⁶

The option of a robotic mission to HST faltered as O'Keefe departed NASA. Through the summer and fall of 2004 and the winter of 2005, NASA and contractors continued to develop the robotic option. A NASA procurement notice in June 2004 announced that Canadian space contractor MacDonald Dettwiler and Associates, Ltd. (MDA) would be the only company invited to bid on the robotic work because it was the only firm with equipment available that would meet the deadline for a robotic servicing mission. MDA's MD Robotics Division in Brampton, Ontario, had built robotic systems for the Space Shuttle, the ISS, and the U.S. military, including the Dextre robot that MDA was building to perform ISS maintenance. NASA and MDA were considering using Dextre to perform servicing work on HST instead of on board the ISS. MDA began work in October on a 30-month, \$154-million contract to provide a robotic system to service HST, and in December, MDA signed a contract with Lockheed Martin, which was designing a spacecraft to carry the MDA robot to rendezvous and dock with HST. The Canadian contractor announced on 5 January 2005 that its 30-month contract with NASA had been formally signed. But in March, the robotic servicing mission went by the wayside when NASA decided not to continue with the concept beyond the preliminary design phase. Instead, NASA decided to continue work on a robotic mission to attach a de-orbit module to HST.⁶⁷



▲ President George W. Bush announces his Vision for Space Exploration policy at NASA Headquarters, 14 January 2004. (NASA)

When the President's proposed 2006 budget for NASA was released on 7 February 2005, it contained no funding for a Shuttle servicing mission. The budget also scaled back plans for robotic servicing, and instead proposed a simplified robotic mission to reach HST and de-orbit it safely over an ocean. O'Keefe, then in his final days as Administrator, said the NRC report findings on the robotic mission made it "incredibly difficult" for NASA to proceed with the idea. Senator Mikulski, for her part, promised to keep fighting for additional funding that would allow a servicing mission for HST. She also kept pressing NASA to continue work on SM4.⁶⁸ Others in Congress also showed support for the HST servicing mission. A 2 February House Science Committee hearing on HST was told that the fate of SM4 might turn on how the costs of the

Wide Field Camera 3 (WFC3)

Time on HST:

14 May 2009–present

Contractor:

Ball Aerospace

Science Oversight Committee

Chair: Bob O'Connell
(University of Virginia)

Weight: 404 kilograms
(890 pounds)

Radial Instrument

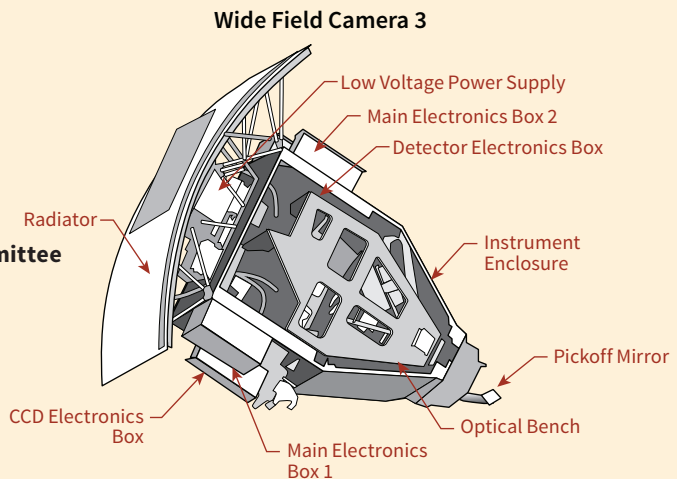

Wide Field Camera 3 operates from the radial instrument bay in HST previously occupied by the two Wide Field Planetary cameras. It also has near-infrared capabilities that expand on the work of NICMOS, as well as a wide field of view and high sensitivity. In the absence of a proposal for a new camera for HST, NASA created an international community-based Science Oversight Committee in 1998 with responsibility for WFC3, and it was developed by NASA Goddard with STScI and Ball Aerospace. The instrument uses many components from WF/PC, which flew on HST

Shuttle mission were charged. Witnesses including Beckwith and Princeton physicist (and Nobel laureate) Joseph Taylor told the committee that NASA usually charged the NASA science budget between \$300 and \$400 million for each servicing mission, with the balance of the cost being charged to NASA's human spaceflight program. If the entire cost of such a mission, in excess of \$1 billion, came out of the science budget, the two witnesses warned that most scientists would oppose the mission because of the cuts that would then be made to other NASA science missions. The hearing also included discussions about the dangers of flying a servicing mission.⁶⁹

Although the robotic mission plans had fallen by the wayside, the effort helped keep the HST servicing mission team together. Without O'Keefe's

from 1990 to 1993, including the external shell, radiator, and filter wheel. The optical bench is new, and WFC3's internal optics compensate for the effects of spherical aberration in HST's main mirror.^a

WFC3 is known as HST's only "panchromatic" instrument because its two channels cover wavelengths from the near ultraviolet to the near infrared. The UVIS channel covers near-ultraviolet and optical wavelengths, 2,000 to 10,000 angstroms, using two CCDs, each 4,096 by 2,098 pixels in size. The IR channel operates in the near infrared at 8,000 to 17,000 angstroms using a single mercury cadmium telluride detector of 1,096 pixels square and an innovative cooling system that makes cryogenic agents unnecessary to keep the detector cold as in NICMOS.^b

Because of its great capabilities, WFC3 can be used in many studies, including those focusing on the evolution of the universe, star populations in nearby galaxies, dark matter, and dark energy, often in tandem with ACS and other instruments. WFC3 has been used to take many well-known images since its installation, including the updated version in 2015 of the "Pillars of Creation" image, Mystic Mountain in the Carina Nebula, and an infrared view of the Horsehead Nebula.^c

a Buddy Nelson, *Hubble Space Telescope Servicing Mission 4 Media Guide* (Lockheed Martin, 2009).

b STScI, *Wide Field Camera 3 Instrument Handbook for Cycle 25, Version 8.0* (Baltimore, MD: STScI, January 2016); John W. MacKenty, "Wide Field Camera 3: Design, Status, and Calibration Plans," *2002 HST Calibration Workshop*, eds., S. Arribas, A. Koekemoer, and B. Whitmore, *2002 HST Calibration Workshop* (Baltimore, MD: STScI, 2002).

c Nelson, *HST Servicing Mission 4 Media Guide*.

agreement that allowed Cepollina and his team to keep working on the robotic servicing mission, Grunsfeld feared that Cepollina's team would have been split up, and contracts for SM4 with firms such as Lockheed Martin would have been terminated. "And that's what allowed the whole Hubble team—the people building the instruments and electronics and all the fixes for SM4 to continue working on SM4," Grunsfeld explained.⁷⁰ The robotic servicing mission concept bought Hubble supporters such as Grunsfeld and Weiler time to save Servicing Mission 4, and it allowed O'Keefe to avoid antagonizing powerful members of Congress while he tried to win support for the Bush administration's space proposals. The work done on robotic servicing for HST stimulated interest in the technologies behind it. But the great expense of a robotic servicing mission, coupled with the limited time available to mount any servicing mission to HST, meant that the robotic solution to Hubble's problems was not feasible.

A NEW ADMINISTRATOR

President Bush nominated Michael D. Griffin as the next Administrator of NASA on 14 March. Griffin, an engineer and physicist who was then working at the Johns Hopkins University Applied Physics Laboratory, had previously worked at NASA, the Strategic Defense Initiative Organization, and in the aerospace industry. Griffin came to his new post prepared to deal with the matter of HST's servicing mission because he had conducted an unpublished independent assessment for NASA examining the feasibility of a robotic mission to HST. When he appeared before a friendly Senate confirmation hearing on 12 April and was questioned about HST, he ruled out a robotic servicing mission and promised to "reassess" his predecessor's decision against a Shuttle servicing mission.⁷¹ Griffin was confirmed by the Senate the next day and quickly took office.⁷²



▲ Dr. Michael Griffin served as NASA's eleventh Administrator from 14 April 2005 to 20 January 2009. (NASA)

The Space Shuttle was still grounded when the new Administrator moved into NASA Headquarters. Solutions to the immediate cause of Columbia's loss—loose foam from the external tank striking and breaching the Shuttle's thermal protection system—were prerequisites for Servicing Mission 4. NASA slated two missions to the ISS to test procedures for verifying the safety of the system, including close-up imaging from a boom attached to the Shuttle robotic arm and further images from the Space Station, to ensure that the Shuttle could return to regular flight operations. Nearly 30 months after Columbia's loss, Discovery lifted off from the Kennedy Space Center on 26 July 2005. While the 14-day STS-114 mission successfully delivered equipment to the ISS and tested out the procedures to verify the integrity of the Shuttle's thermal protection system, that system had again been endangered by a piece of foam from the external tank striking the Shuttle during launch. Later in the flight, an astronaut made a spacewalk to the underside of Discovery to adjust pieces of the thermal protection system. As a result of the foam problem, the second Shuttle test flight was postponed for several months while engineers worked to resolve the issue. Engineers found that air ramps on the external tank were the source of the loose foam on STS-114, and so they were removed from the external tank due to launch Discovery on its next mission, STS-121. The fix worked, and STS-121 completed a successful mission in July 2006 to deliver equipment and a crew member to the Space Station. Two months later, Atlantis on the STS-115 mission repeated the success of the second return-to-flight mission, and construction activity resumed at the ISS.⁷³

SM4 REINSTATED

With two Shuttle flights successfully completed without thermal protection system problems, Griffin was ready to decide the fate of SM4 and HST. After briefings in the final days before he announced his decision, Griffin went to GSFC on 31 October 2006, and told employees that SM4 was back on the Shuttle launch manifest. Mikulski was among those on hand who applauded the decision. Griffin set the timing of the mission for the “spring to fall” of 2008, with the needs of the ISS and the Shuttle launch schedule in mind. The special safety precautions for the servicing mission included a plan to have a Launch on Need Shuttle mission to rescue the crew of SM4 on orbit in case the Shuttle's thermal protection system was breached during launch. This safety measure required that both Shuttle launch pads at Kennedy Space Center and two Shuttles be available to support both SM4 and the contingency flight. “We have conducted a detailed analysis of the performance and procedures necessary to carry out a successful Hubble repair mission over the course of the

last three Shuttle missions. What we have learned has convinced us that we are able to conduct a safe and effective servicing mission to Hubble,” Griffin said. He also announced the crew for SM4: commander Scott D. Altman, pilot Gregory C. Johnson, veteran servicing mission spacewalkers John M. Grunsfeld (recently returned to the astronaut office from NASA Headquarters) and Michael J. Massimino, along with three rookie astronauts, spacewalkers Andrew J. Feustel and Michael T. Good, and arm operator K. Megan McArthur. At that point, SM4 was designated to install WFC3 and COS in place of WFPC2 and COSTAR, along with a refurbished fine guidance sensor and new gyroscopes. The crew was also slated to perform repairs on STIS, which had stopped operating in 2004.⁷⁴

Even before he reinstated SM4, Griffin had decided against devoting all or part of a Shuttle mission to attaching a module with a reentry rocket to HST. He had already learned that Hubble’s orbit would not decay at a rate that would cause a reentry before the 2020s. If NASA judged later on that it needed to attach a reentry module to the telescope, Griffin said NASA could launch it

Cosmic Origins Spectrograph (COS)

Time on HST:

16 May 2009–present

Contractor:

Ball Aerospace

Principal Investigator:

James Green
(University of Colorado)

Weight: 385 kilograms
(850 pounds)

Axial Instrument

Cosmic Origins Spectrograph

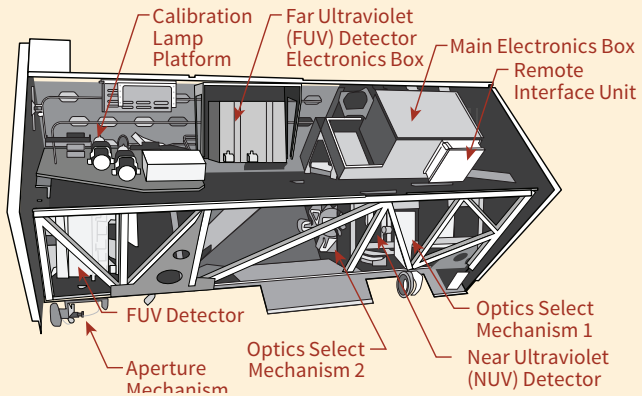

The Cosmic Origins Spectrograph (COS) contains two channels, the Far Ultraviolet channel covering wavelengths from 1,150 to 1,770 angstroms, and the Near Ultraviolet (NUV) channel for wavelengths from 1,750 to 3,000 angstroms. The NUV

on the Ares rocket, then under development for the Constellation program. “I didn’t see why I would put a reentry module on [HST]. That would just tempt people to use it,” Griffin explained later.⁷⁵

Even though Hubble was still in a secure orbit when Griffin announced that SM4 was back on, the concerns O’Keefe and others had about HST’s limited working lifetime remained because HST was operating on just two of its six gyroscopes. HST had switched to two-gyro operations for the first time in August 2005 with engineers and scientists hoping that it could continue science work into the second half of 2008 when SM4 was due to fly. While the telescope was designed to operate on three or more gyros, the move to two gyros was extensively tested before the troubled but still operating third gyro was shut down. Hubble’s Advanced Camera for Surveys also stopped functioning in January 2007 when its backup power supply suffered a short circuit, which added another task to the repairs planned for the upcoming servicing mission. On a more positive note, the delays to the mission caused by O’Keefe’s cancellation decision had allowed engineers at Ball Aerospace and NASA to install

channel uses a flight spare NUV Multi-Anode Microchannel Array (MAMA) from STIS.^a COS is designed for maximum efficiency with light, to better collect light from distant objects. It reused the optical bench from GHRS as a cost-saving measure.

The primary design goal of COS is to improve the sensitivity of HST to point sources in the far ultraviolet. With the installation of COS and the repair of STIS during Servicing Mission 4, HST has two spectrographs with significant overlap in spectral range and resolving power. Each has unique capabilities, and the decision of which to use is driven by the science goals of the program and the nature of the target to be observed.^b

A major goal of COS is to measure the structure and composition of matter in the universe, including the mysterious dark matter that constitutes most matter in the universe. COS’s internal optics were designed to compensate for the effects of spherical aberration in HST’s main mirror.

^a J. Gethyn Timothy, “Review of Multianode Microchannel Array Detector Systems,” *Journal of Astronomical Telescopes, Instruments, and Systems* 2, no. 3, 030901 (July–September 2016): 17.

^b Space Telescope Science Institute, *Space Telescope Imaging Spectrograph Instrument Handbook for Cycle 24, Version 15.0* (Baltimore, MD: STScI, January 2016), p. 17.

better detectors on board the new WFC3 instrument than would have been the case had it flown as originally planned. In June 2007, NASA announced that SM4 would fly on the Shuttle Atlantis as mission STS-125, with a target launch date of 10 September 2008.⁷⁶

NASA later postponed the launch date to 14 October. With Atlantis already standing on Pad 39A at KSC, HST's main computer ordered the telescope's payload computer and the science instruments to go into safe mode on the evening of Saturday 27 September. After 18 years of operation, one of two sides inside HST's main data handling unit, the Science Instrument Command and Data Handling system, had failed. While controllers established that the second side of the unit could be pressed into service, the failure of the first side left Hubble operations vulnerable to single-point failures in this unit, something that could shorten HST's lifetime. In a conference call later that weekend, Griffin decided to postpone the launch while HST engineers and managers decided whether SM4 should also include installation of a new data handling unit.⁷⁷ Grunsfeld later called the event an "extraordinarily rare occasion of a large group of NASA engineers and administrators making a quick decision."⁷⁸ Atlantis was moved off the launch pad and returned to the Vehicle Assembly Building, while Goddard engineers took a backup data handling unit out of storage and began to test and refurbish it in anticipation of installing it in HST. At the end of October, NASA rescheduled STS-125 for launch the following May so that the backup unit could be installed.⁷⁹

Testing and updating of the data handling unit, which included parts built in the 1980s by people who were long retired by 2008, proved to be a challenge for engineers at Goddard and KSC. And the people who prepared Atlantis and its crew for launch faced other challenges. They included coordinating SM4's flight with complicated launch schedules that involved coordination with Shuttle flights to the ISS and also what turned out to be the only launch of the Ares rocket.⁸⁰ Cepollina's team at Goddard and engineers at Johnson Space Center had already created special tools and trained the crew to repair STIS and ACS, work that had never been contemplated in the early years of HST. "On paper," said HST Deputy Project Scientist Mal Niedner, "it looked like the impossible mission."⁸¹

SM4 FLIES

After all the technical and political problems that delayed and nearly blocked the launch, the fifth and final servicing mission to HST lifted off as planned at 2:01 p.m. EDT on 11 May 2009, from KSC. As Atlantis roared into the afternoon sky from Pad 39A, Endeavour stood by on Pad 39B in case it was

needed to rescue the seven astronauts of STS-125. A four-member crew for the emergency mission, designated as STS-400, had been formed from the crew of the recent STS-126 mission: Christopher J. Ferguson, Eric A. Boe, Robert S. Kimbrough, and Stephen G. Bowen. If necessary, Endeavour would have rendezvoused with Atlantis and grappled it while the two Shuttles faced each others' payload bays. The astronauts of STS-400 would have transferred the seven astronauts of STS-125 to Endeavour during three spacewalks. These measures were not necessary, however, and Endeavour was soon freed for preparations for its next mission to the ISS.

On their second day on orbit, the crew of STS-125 spent seven hours conducting a close inspection of Atlantis' thermal protection system and external surfaces with imaging equipment mounted on the orbital boom system attached to the Shuttle's robotic arm. While the crew found some minor damage, engineers at Mission Control in Houston determined that the damage would not present a problem.⁸²

Attention returned to the Hubble Space Telescope the next day when Altman and Johnson guided the Shuttle to a rendezvous with HST, and McArthur grappled it with Atlantis' robotic arm and affixed it to the Shuttle's flight support system with its mechanical and electrical connections. On day four, Grunsfeld and Feustel emerged from the Shuttle airlock and began removing WFPC2 from Hubble to replace it with the powerful new camera, WFC3. Feustel could not loosen a large bolt that held WFPC2 inside HST when he first attempted the task with the expected amount of torque. Amid serious fears that the bolt might break if he applied too much torque, which would have halted the replacement of the instrument, Feustel installed a torque limiter and tried again using more force but without success. In a risky procedure, he tried once more to loosen the bolt without the torque limiter, and finally freed the bolt and the instrument. "I can tell you I'm five years older now than I was when I came to work this morning," Senior Project Scientist David Leckrone told journalists after the EVA.⁸³ Ray Villard, the veteran STScI news director, called this the "scariest moment" of his long career with HST.⁸⁴ After the two astronauts replaced WFPC2 with the new WFC3, they replaced the critical data handling unit that had caused the mission to be postponed. Finally, Grunsfeld went to the bottom of HST and installed a grapple fixture that could be used by future spacecraft to link up for HST de-orbit operations. The spacewalk ended after seven hours and 20 minutes.⁸⁵

Massimino and Good replaced all three rate sensing units and a battery during the second EVA on day five. Each of the rate sensing units contained two gyroscopes, so all six of the space telescope's gyroscopes were replaced, but

the spacewalk lasted longer than planned because one of the new rate sensing units wouldn't fit correctly into its place due to too much insulating material being stuffed into the unit. Ultimately, the astronauts installed a backup rate sensing unit in place of the unit that wouldn't fit. Although the problem was barely noted in coverage of the spacewalk, it bears on the future of HST. Earlier versions of the



▲ HST Senior Project Scientists David Leckrone and Jennifer Wiseman in the Flight Control Room at Johnson Space Center during Servicing Mission 4 in 2009. (NASA/ Michael Soluri)

gyroscopes, including the two installed in the backup rate sensing units and one of four contained in the new units, are subject to a problem that limits the life of gyroscopes. Wires that carry power through a thick fluid to the spinning wheel inside each of those gyros are subject to corrosion. The three newer gyroscopes installed during the spacewalk and two that couldn't be installed were equipped with wires coated to resist corrosion. The three gyroscopes installed in SM4 without the coated wires had failed by 2018, leaving only three operating gyros to carry the full burden of keeping track of HST's frequent changes in direction.⁸⁶

On the sixth day of the mission, Feustel and Grunsfeld replaced COSTAR with the new Cosmic Origins Spectrograph, and Grunsfeld repaired the Advanced Camera for Surveys. Because ACS's internal systems had not been designed to be repaired by astronauts, the success of this repair depended on specially developed tools, including a device that fit over the access panel covering four circuit boards that had to be replaced to restore power to ACS. It allowed Grunsfeld to remove and capture the 32 screws that held the panel in place without fear of the screws flying free inside the instrument.⁸⁷

During the fourth EVA, Massimino and Good repaired STIS, and this time the work involved a specially designed plate to capture 107 of 111 screws on a cover plate that led to a failed power supply card. That difficult task went well, but only after Massimino stripped a bolt while removing a handrail. "I felt like I was living a nightmare," Massimino said of his efforts to free the handrail



▼ STS-125 crew insignia. (NASA)



► Perched on the end of the Canadian-built Remote Manipulator System, astronaut Andrew Feustel, mission specialist, performs work on the Hubble Space Telescope during the first of five STS-125 spacewalks, kicking off a week's work on the orbiting observatory. (NASA)



▲ SM4 insignia from GSFC. (NASA)



▲ Design for STS-400 emergency rescue mission crew insignia. (NASA)



► STS-125 crew members on the flight deck of the Shuttle Atlantis. Back row (left to right) mission specialists Michael Good, Mike Massimino, John Grunsfeld, and Andrew Feustel. Front row (left to right) commander Scott Altman, mission specialist Megan McArthur, and pilot Gregory C. Johnson. (NASA)

until a solution came from ground control.⁸⁸ Since the handrail would never be needed after STS-125, Massimino broke it free, which allowed him and Good to proceed with the intricate repairs to STIS. Grunsfeld and Feustel began the fifth and final spacewalk of the mission on 18 May earlier than planned to make sure they had time to complete every task. They swapped out a second battery in HST for a fresh one, and replaced a fine guidance sensor with a refurbished unit. Finally, the two spacewalkers installed new thermal control blanket layers on three bays on the outside of the telescope. As the spacewalk wound up, Grunsfeld marked the end of his eight spacewalks to HST over three flights by paying tribute to the telescope: “Hubble is not just a satellite,” Grunsfeld said. “It’s a symbol of humanity’s quest for knowledge.”⁸⁹

The next day, 19 May, McArthur lifted HST from its berth in the Shuttle payload bay, and at 8:57 a.m. EDT, released HST from the Shuttle for the last time. A half hour later Atlantis moved away from the telescope. The crew then had time to rest, enjoy the view from the Shuttle, and prepare for landing, including a final inspection of the thermal protection system. During this time the crew spoke with President Barack Obama and became the first people to give congressional testimony from space when they spoke to the Senate Appropriations Committee, Subcommittee on Commerce, Justice, Science and Related Agencies, then chaired by Senator Mikulski. Rainy weather at the main Shuttle landing facility in Florida caused landing attempts on 22 and 23 May to be cancelled, and finally on Sunday, 24 May, Mission Control decided to have the STS-125 crew land Atlantis at Edwards Air Force Base in California. After Atlantis’ successful return that day, Weiler, NASA’s Associate Administrator for Space Science, recalled the day the servicing mission was cancelled in January 2004. “If you’d have told me on that day I’d be sitting here five years later with a totally successful five-EVA mission, with a brand new Hubble once again that will probably operate well into the third decade of its life, I wouldn’t have bet you a penny,” Weiler said. “But Hubble is the great American comeback story, chapter two.”⁹⁰

CELEBRATING SUCCESS

In a ceremony the following September at NASA Headquarters, astronomers and politicians proclaimed the work of SM4 a success. Senator Mikulski unveiled dramatic images, including the Butterfly Nebula and galactic clusters, from the four instruments installed or repaired on STS-125, and scientists said the new instruments, COS and WFC3, made HST a better observatory than ever. “I fought for the Hubble repair mission because Hubble is the people’s telescope,” Mikulski said, highlighting the contributions of experts from her home state

of Maryland.⁹¹ Michael Griffin's decision to reverse O'Keefe's cancellation of SM4 was widely praised, and even O'Keefe has expressed agreement with flying the mission, because HST lasted long enough that NASA was able to meet the safety criteria set by the Columbia Accident Investigation Board for SM4.⁹²

The successful completion of SM4 left HST with five operational scientific instruments, including astrometry capability of the Fine Guidance Sensors. (NICMOS was no longer being used after 2008 because its cooling equipment had degraded, and many of its infrared capabilities were exceeded by ACS and WFC3.) The second- and third-generation instruments that HST carried represented a major increase in capability over those originally flown in 1990—a 90-fold increase in power, according to veteran astronomer Sandra M. Faber.⁹³

The Shuttle Program's relationship with HST ended with the return of STS-125, and the Shuttle's remaining missions from that time were devoted to further assembly of the International Space Station. A little more than two years later on 21 July 2011, Atlantis closed out 30 years of Space Shuttle operations when it landed at the Kennedy Space Center at the end of the Shuttle Program's 135th mission. The flight was the Shuttle's final visit to the ISS, which along with the Hubble Space Telescope, will be remembered as one of the Shuttle's most important legacies.

Starting with the first Shuttle flight on 12 April 1981, 355 individuals from 16 countries flew 852 times aboard the Shuttle. The five Shuttles traveled more than 542 million miles (872 million kilometers) and hosted more than 2,000 experiments in the fields of Earth, astronomical, biological, and materials sciences. Shuttles deployed 180 payloads, including satellites, returned 52 from space and retrieved, repaired and redeployed seven spacecraft. HST was the most famous deployment from the Shuttle, and its five servicing missions to HST are amongst the best-known Shuttle missions of the whole program.⁹⁴

With HST reduced to two-gyro operation and with an ailing data handling unit and three malfunctioning instruments in 2007, it is likely that HST's mission would have ended before its 20th anniversary in 2010 without Servicing Mission 4. Instead, the success of SM4 allowed astronomers to continue HST operations into a third and even a fourth decade, and plan joint operations involving both HST and JWST. The public reaction to Sean O'Keefe's decision to cancel SM4 showed the depth of popularity HST enjoyed amongst astronomers and the public. Recalling the delays that amongst other things gave time to find better detectors for WFC3, Ken Sembach, STScI director starting in 2015, said, "The cancellation of SM4 in 2004 was a tremendous boon to science."⁹⁵ And the ultimate success of SM4 depended on more than determined and skilled astronauts—it also required engineers, technicians, and scientists from

NASA and its contractors to create solutions to unanticipated problems such as the failures of ACS, STIS, and the data handling unit. SM4 was originally conceived as the opening of both the final phase of HST operations and the transition to Hubble's successor, the James Webb Space Telescope. With HST and most of its instruments still going strong more than a decade later as the long-delayed launch of JWST draws near, SM4 has joined the dramatic first servicing mission as a high point in the story of the Hubble Space Telescope.

ENDNOTES

- 1 Alan Dressler, ed., *Exploration and the Search for Origins: A Vision for Ultraviolet Optical-Infrared Space Astronomy: A Report of the "HST & Beyond" Committee* (Washington, DC: Association of Universities for Research in Astronomy, 15 May 1996), pp. 7–14, 35. The Dressler report also called for NASA to join the search for planets around other stars by developing the capacity for space interferometry, an idea that as of 2020 still has not moved ahead as the search for exoplanets continued using other methods. The committee included Robert A. Brown, Michael G. Hauser, and Peter Stockman of STScI, Arthur F. Davidsen of Johns Hopkins, Richard S. Ellis of Cambridge University, Wendy L. Freedman of Carnegie Observatories, Richard F. Green of NOAO, Robert P. Kirshner of Harvard, Shrinivas Kulkarni of Caltech, Simon J. Lilly of the University of Toronto, Bruce H. Margon of the University of Washington, Carolyn C. Porco of the University of Arizona, Douglas O. Richstone of the University of Michigan, Harley A. Thronson, Jr., of the University of Wyoming, John L. Tonry of MIT, James Truran of the University of Chicago, and Edward J. Weiler of NASA Headquarters.
- 2 Space Science Board, National Research Council, *Space Science in the Twenty-First Century: Imperatives for the Decades 1995 to 2015, Astronomy and Astrophysics* (Washington, DC: National Academy Press, 1988), p. 47.
- 3 Pierre-Yves Bely, Christopher J. Burrows, and Garth D. Illingworth, eds., *The Next Generation Space Telescope: Proceedings of a Workshop Jointly Sponsored by the National Aeronautics and Space Administration and the Space Telescope Science Institute Held at the Space Telescope Science Institute, Baltimore, Maryland, 13–15 September 1989* (Baltimore, MD: STScI, 1989), p. 1.
- 4 Astronomy and Astrophysics Survey Committee, Board on Physics and Astronomy, National Research Council, *The Decade of Discovery in Astronomy and Astrophysics* (Washington, DC: National Academy Press, 1991), pp. 10, 75–81. For an overview of early efforts to promote the NGST up to the early 1990s, see Robert W. Smith and W. Patrick McCray, "Beyond the Hubble Space Telescope: Early Development of the Next Generation Space Telescope," in H. A. Thronson et al., eds., *Astrophysics in the Next Decade, Astrophysics and Space Science Proceedings* (Springer Science+Business Media B. V., 2009), pp. 31–50.

- 5 STScI, "NASA Selects Home for Next Generation Space Telescope," news release 1998-20, 8 June 1998; "Webb Project History," <http://webbtelescope.org/article/History/5> (accessed 18 June 2017).
- 6 Dressler, ed., *Exploration and the Search for Origins*, pp. 22–23.
- 7 NASA Announcement of Opportunity, "Hubble Space Telescope, Opportunity an Propose Flight Investigations for the 2002 Servicing Mission" (AO-96-OSS-03, 1 November 1996), p. 3.
- 8 David Leckrone, "The Second Decade of HST: Report from the HST Project Scientist," *Space Telescope Science Institute Newsletter* 15, no. 1 (January 1998): 20.
- 9 David Leckrone, "Report from the HST Project Scientist," *Space Telescope Science Institute Newsletter* 15, no. 2 (April 1998): 12–13. James C. Green, oral history interview by author, 24 September 2015.
- 10 Leckrone, "Report from Project Scientist" (April 1998); David Leckrone, oral history interview by author, 6 November 2015, part 2, pp. 17–19; Harley Thronson, oral history interview by author, 12 May 2015, pp. 6–14.
- 11 John MacKenty, "Progress on WFC3," *Space Telescope Science Institute Newsletter* 19, no. 2, pp. 9–10; David Leckrone, oral history interviews by author, 13 June 2016, pp. 1–5; Harley Thronson, 12 May 2015, pp. 3–4; Edward Cheng, 17 June 2016, pp. 6–9; Randy Kimble, 1 November 2016, pp. 8–14; and Mal Niedner, pp. 7–8, 13–16. Ed Weiler, personal communication with author, 20 June 2017. For more on the Second Decade Committee, see "Slides for Presentation to Space Telescope Users Committee meeting, May 17 and 18, 1988," STScI Archive, Box 1.1, file "STUC Documents Sent, Spring 1998," JHU Library Special Collections; and "STScI, "Space Telescope Users Committee Minutes of the May 1998 Meeting," https://www.stsci.edu/files/live/sites/www/files/home/hst/about/space-telescope-users-committee/committee-reports/_documents/stuc_may98_report_and_minutes.pdf (accessed 26 July 2020); NASA Facts, "Hubble Space Telescope Servicing Mission 4 Wide Field Camera 3" (NASA, Goddard Space Flight Center, FS-2006-10-084-GSFC).
- 12 Leckrone, "The Second Decade of HST," January 1998. This was written before SM3 was split into two missions. SM4 remained in the plans, but at a later date.
- 13 Leckrone, "Report from the HST Project Scientist," April 1998.
- 14 Leckrone, *Ibid.*
- 15 W. Henry Lambright, "Leadership and Change at NASA: Sean O'Keefe as Administrator," *Public Administration Review*, (March–April 2008), pp. 230–240; Sean O'Keefe, oral history interview by author, 5 June 2017, pp. 2–10.
- 16 O'Keefe OHI, pp. 2–3, 9; NASA, "Diverse Space Shuttle Flights to Set Records, Continue Challenges in 2002," news release H01-256, 31 December 2001; Steven Beckwith, "Good Times," *Space Telescope Science Institute Newsletter* 19, no. 3 (2003): 4.
- 17 *Columbia Accident Investigation Board Report, Volume 1* (Washington, DC: U.S. Government Printing Office, August 2003), pp. 27–28.
- 18 See chapter five of the *Columbia Accident Investigation Board Report (CAIB Report)*.

- 19 See chapter two of the *CAIB Report*.
- 20 Michael Cabbage and William Harwood, *Comm Check... The Final Flight of Shuttle Columbia* (New York: Free Press, 2004), pp. 154–160; Dr. Edward J. Weiler interviewed by Dr. Stephen J. Dick, Washington, DC, 2 February 2004, NASA Headquarters oral history project, p. 2. Among the missions affected by Challenger’s loss were deployment missions from the Shuttle requiring the liquid-fueled Centaur rocket, which were shifted to lower-risk solid fuel boosters. Planned polar orbit missions launching out of California were also cancelled.
- 21 *CAIB Report*, p. 11.
- 22 *CAIB Report*, pp. 173–174.
- 23 *CAIB Report*, pp. 208–209. For background on the development of this new space policy, see Glen R. Asner and Stephen J. Garber, *Origins of 21st-Century Space Travel: A History of NASA’s Decadal Planning Team and the Vision for Space Exploration, 1999–2004* (Washington, DC: National Aeronautics and Space Administration, NASA SP-2019-4415, 2019); and Frank Sietzen, Jr. and Keith L. Cowing, *New Moon Rising: The Making of America’s New Space Vision and the Remaking of NASA* (Burlington, ON: Apogee Books, 2005).
- 24 Hubble Space Telescope Post-SM4 Scientific Review Panel, *Final Report of the Hubble Space Telescope Post-SM4 Scientific Review Panel* (Washington, DC: NASA, 25 April 2003), posted at http://nicmosis.as.arizona.edu:8000/REPORTS/Post-SM4_Final_Report.pdf (accessed 8 September 2015). The panel’s membership also included Alan Dressler of Carnegie Observatories; Robert C. Kennicutt and Glenn H. Schneider of the University of Arizona; George K. Miley of Leiden University; William R. Oegerle of NASA Goddard; and J. Michael Shull of the University of Colorado.
- 25 *Ibid.*
- 26 John Bahcall et al., *Report of the HST-JWST Transition Panel* (Washington DC: NASA, August 2003). Available at http://www.nasa.gov/pdf/49151main_hst-jwst.pdf (accessed 6 September 2015). The other members of this panel were Barry C. Barish of Caltech; Jacqueline N. Hewitt of MIT; Christopher F. McKee and Charles Townes of UC Berkeley; and Martin Rees of Cambridge University.
- 27 University of California Berkeley Press Release, “How and when to Bring the Hubble Space Telescope home,” 21 August, 2003. Posted at <http://www.spaceref.com/news/viewpr.html?pid=12370> (accessed 6 September 2015); John Grunsfeld interviewed by Dr. Stephen J. Dick, Washington, DC, 13 April 2004, NASA Headquarters oral history project, pp. 6–7; John Grunsfeld, oral history interview by author, 2 November 2016, pp. 14–15; Bahcall, *HST-JWST Transition Panel*, p. 4, 6; Steven V. W. Beckwith, *The Hubble-JWST Transition: A Policy Synopsis* (Baltimore, MD: STScI, 18 July 2003).
- 28 Kathy Sawyer, “Now in Their Sights, the Hubble’s Demise,” *Washington Post* (17 November 2003): A12.
- 29 Anne L. Kinney, *HST Lifetime and End-of-Mission Scenarios*, PowerPoint slides, 23 October 2003, NASA History Office, (file on SM4 report). The most recent Decadal Survey of Astronomy and Astrophysics of the U.S. National Research Council, released in 2000, had been chaired by Christopher McKee of the University of California and Joseph Taylor of Princeton University.

- 30 Weiler, 2 February 2004, pp. 4–6, 12–13; Edward J. Weiler, *HST SM4 Options Briefing with Mr. O'Keefe*, PowerPoint slides, 7 November 2003, NASA History Office (file on SM4 report). In an interview with the author on 24 October 2016, Weiler repeated his concerns in 2003 about the possibility of losing SM4 at a time when many scientists were focused on lobbying for SM5. See also *Return to Flight Task Group, Final Report of the Return to Flight Task Group* (Washington, DC: NASA, July 2005). This report provides an accounting of the many measures that NASA took to prepare the Shuttle fleet to fly to the ISS after the Columbia disaster.
- 31 Sean O'Keefe interviewed by Dr. Stephen J. Dick, Washington, DC, 22 April 2004, NASA Headquarters oral history project, p. 2.
- 32 Dr. Steve Isakowitz interviewed by Dr. Steven J. Dick, Washington, DC, 18 February 2004, NASA Headquarters oral history project, pp. 9–11; O'Keefe OHI, 5 June 2017.
- 33 Sean O'Keefe interviewed by Dr. Steven J. Dick, Washington, DC, 29 October 2004, NASA Headquarters oral history project, p. 3.
- 34 O'Keefe interview, 22 April 2004, p. 3.
- 35 Steven J. Dick, "Appendix: The Decision to Cancel the Hubble Space Telescope Servicing Mission 4 (and Its Reversal)," in *Hubble's Legacy*, eds., Launius and DeVorkin; Weiler interview, 2 February 2004, pp. 5–9; O'Keefe interview, 22 April 2004, pp. 4–5.
- 36 Grunsfeld interview, 13 April 2004, p. 13.
- 37 Grunsfeld OHI, 2 November 2016, p. 4.
- 38 This paragraph is based on Steven Dick's 2004 interview with Grunsfeld and the author's 2016 interview with Grunsfeld.
- 39 Sietzen and Cowing, *New Moon Rising*, pp. 160–166; Dick, "The Decision to Cancel," pp. 165–167.
- 40 Kathy Sawyer, "Visions of Liftoff, Grounded in Political Reality," *Washington Post* (15 January 2004): A1.
- 41 E-mails between NASA Chief Historian Steven J. Dick and Assistant Administrator for Legislative Affairs Lee Forsgren, "HST SM4," 26 July 2004, printout in NASA Headquarters History oral history project file; Lambright, "Leadership and Change," p. 237.
- 42 Dennis Overbye, "NASA Cancels Trip to Supply Hubble, Sealing Early Doom," *New York Times* (17 January 2004): A1; Grunsfeld, Weiler, and O'Keefe 2004 interviews by Steven Dick.
- 43 Weiler OHI, pp. 19–20; Beckwith OHI, p. 25; Michael Griffin, oral history interview by author, 22 May 2017, pp. 3–4; Griffin comments during Hubble 25th Anniversary Panel, "SM4: The Last Servicing Mission to Hubble," 23 April 2017, recorded on DVD (Baltimore, MD, STScI); O'Keefe OHI, 5 June 2017, p. 20. While Weiler was harshly critical of O'Keefe in his 2016 interview, many others raised their criticisms in unrecorded conversations. Some have linked O'Keefe's departure from NASA to an inquiry by the U.S. Government Accountability Office into the use of NASA passenger aircraft. While the report criticized the cost of this service, it made no reference to O'Keefe's use of NASA aircraft. See U.S. Government Accountability Office, *NASA Travel: Passenger Aircraft Services Annually Cost Taxpayers Millions More Than Commercial Airlines* (Washington, DC: GAO-05-818, August 2015).

- 44 The report was completed in December 2004, and it was published in 2014 with an additional section on the reversal of the cancellation decision. Many documents and interviews that Dr. Dick collected for this report have been used as references for this chapter. Dick, "Appendix: The Decision to Cancel," note 1, p. 187.
- 45 Ibid., p. 180.
- 46 Ibid., pp. 180–183.
- 47 O'Keefe OHI, 5 June 2017, pp. 14–16.
- 48 Ibid., p. 14.
- 49 Ibid., p. 16.
- 50 Guy Gugliotta, "Doomed Hubble's Fans Flood NASA with Ideas," *Washington Post* (21 March 2004): A1; O'Keefe interview, 22 April 2004, p. 11; Save the Hubble website, <https://web.archive.org/web/20170703025303/http://www.savethehubble.com/>. (accessed 11 July 2017). For more on opposition to the SM4 cancellation, see David Gaynes, *Saving Hubble* (American Ideal Pictures DVD, 2013).
- 51 Dennis Oberbye, "Engineer's Papers Dispute Hubble Decision," *New York Times* (7 February 2004): A4; Dwayne A. Day, "Shuttle safety and the Hubble Servicing Mission," *The Space Review* (8 March 2004), <http://www.thespacereview.com/article/111/1> (accessed 30 September 2015); Michael Greenfield, *Cancellation of the Fifth (SM-4) Hubble Servicing Mission*, 11 March 2004, NASA History Division; Michael Greenfield interviewed by Steven Dick, 5 November 2004, NASA Headquarters oral history project.
- 52 Stephen Beckwith, oral history interview by author, 9 September 2016, p. 25.
- 53 Beckwith OHI, p. 26.
- 54 Barbara A. Mikulski to Sean O'Keefe, 21 January 2004; Sean O'Keefe to Barbara A. Mikulski, 26 January 2004 and 28 January 2004, NASA History Division; Andrew Lawler, "Academy, GAO to Study Possible Robotic Hubble Mission," *Science* 303 (19 March 2004): 1745; Brian Berger, "Senate Resolution Introduced to Save Hubble Mission," *Spacenews* (29 March 2004): 8; Committee on the Assessment of Options for Extending the Life of the Hubble Space Telescope, National Research Council, *Assessment of Options for Extending the Life of the Hubble Space Telescope* (Washington, DC: The National Academies Press, 2005), pp. 8–9. The GAO was known as the General Accounting Office until 7 July 2004, while it was preparing its report on the HST servicing mission.
- 55 Brian Berger, "Senate Resolution Introduced to Save Hubble Mission," *Spacenews* (29 March 2004): 8; Congressional Record: SUBMITTED RESOLUTIONS (Senate—25 March 2004). The resolution was also sponsored by Kansas Republican Senator Sam Brownback.
- 56 SpaceRef.com, "Letter from Sen. Hutchinson to President Bush—Hubble Repair Petition from Former Astronauts," 28 May 2004. Printout in NASA Headquarters History Office clipping collection.
- 57 Jennifer Wiseman comments during Hubble 25th Anniversary Panel, "SM4: The Last Servicing Mission to Hubble," 23 April 2017, recorded on DVD (Baltimore, MD, STScI).
- 58 Preston Burch, oral history interview by author, 9 November 2015, p. 21.

- 59 Guy Gugliotta, "NASA Weighs Robotic Mission to Aid Hubble," *Washington Post* (10 May 2004): A1; Goddard Space Flight Center, *Hubble Space Telescope Robotic Servicing Mission: Mission Feasibility Study for the WFC3 and COS Scientific Instrument Installation* (Greenbelt, MD: NASA Goddard Space Flight Center, 6 April 2004); Brian Berger and Leonard David, "O'Keefe: Robotic Options for Saving Hubble Promising," *Spacenews* (26 April 2004): 7.
- 60 NASA, "Remarks by Administrator O'Keefe, American Astronomical Society Annual Meeting, Denver Colorado," 1 June 2004; NASA, "NASA Considering Robotic Servicing Mission to Hubble," news release 04-173, 1 June 2004. The speech contained O'Keefe's defense of his decision to cancel SM4 and is remembered for the distribution of STS-107 Columbia pins to members of the audience.
- 61 Louis J. Lanzerotti, chair, Committee on the Assessment of Options for Extending the Life of the Hubble Space Telescope, letter to Sean O'Keefe, 13 July 2004.
- 62 Committee on the Assessment of Options for Extending the Life of Hubble Space Telescope, National Research Council, *Assessment of Options for Extending the Life of the Hubble Space Telescope: Final Report* (Washington, DC: The National Academies Press, 2004), pp. 69, 71.
- 63 *Ibid.*, pp. 81–82.
- 64 Copy of O'Keefe letter of resignation to President George W. Bush posted on Spaceref.com, 13 December 2004; Bolden OHI, pp. 13–15, <http://www.spaceref.com/news/viewpr.html?pid=15664> (accessed 27 May 2016).
- 65 William Harwood, "Reports: NASA Chief Sean O'Keefe May Leave Agency," *Spaceflight Now* and CBS News "Space Place," posted 11 December 2004, <http://www.spaceflighnow.com/news/n0412/11okeefe/>; "Transcript of Press Briefing with NASA Administrator Sean O'Keefe, 17 December 2004," Status Report from NASA Headquarters posted on spaceref.com, <http://www.spaceref.com/news/viewstr.html?pid=14828> (both accessed 28 May 2016); Dick, "The Decision to Cancel," p. 179; O'Keefe OHI, 5 June 2017, p. 24.
- 66 Lambright, "Leadership and Change," p. 238.
- 67 Associated Press, "Canadian Company Wins the Inside Track for Hubble Rescue Robot," *Victoria Times Colonist* (24 June 2004): B2; Guy Gugliotta, "Robot Helps NASA Refocus on Hubble," *Washington Post* (12 November 2004): A3; Jack Kapica, "MDA Lands Hubble Rescue Contract," *The Globe and Mail* (Toronto, Ontario, January 6, 2005); Brian Berger, "NASA Poised to Focus Hubble Work on Deorbit," *Space News* (4 April 2005): 4. See also John Ratti, oral history interview by author, 21 October 2015. Dextre was installed on the ISS in 2008.
- 68 Guy Gugliotta and Rick Weiss, "NASA Gets Increased Funding to Explore the Moon, Mars," *Washington Post* (8 February 2005): A21; Guy Gugliotta, "Hubble Decision a Blow To Goddard Engineers," *Washington Post* (9 February 2005): A03; Spaceref.com, "Letter from Sen. Mikulski to Acting NASA Administrator Fred Gregory regarding Hubble servicing mission work," 2 March 2005, <http://www.spaceref.com/news/viewstr.html?pid=15867> (accessed 8 July 2017).

- 69 Warren E. Leary, "Repair Costs for Hubble are Vexing to Scientists," *New York Times* (3 February 2005); Brian Berger, "Hubble Hearing Opens Debate on a Hot Topic," *Space News* (7 February 2005): 6.
- 70 Grunsfeld, OHI, 2 November 2016, 6. In Weiler, OHI, 24 October 2016, 22, Weiler voices similar sentiments.
- 71 "Transcript of NASA Administrator Nominee Michael Griffin's Confirmation Hearing 12 April 2005," posted 13 April 2005 on spaceref.com, <http://www.spaceref.com/news/viewsr.html?pid=16155> (accessed 28 May 2016).
- 72 NASA, "Michael Griffin Takes Helm as NASA Administrator," 14 April 2005, http://www.nasa.gov/about/highlights/griffin_admin.html (accessed 28 May 2016). Griffin has discussed his role in the independent assessment of the robotic mission on several occasions, including his OHI with the author, pp. 1–2. There he said he was asked by Chris Scolese at GSFC and Ed Weiler to conduct the assessment while he worked at the Applied Physics Laboratory before becoming NASA Administrator. The author could not obtain a copy of the report.
- 73 NASA, "NASA Celebrates Space Shuttle Discovery's Homecoming," news release 05-217, 9 August 2005; NASA, "NASA Targets March for Next Space Shuttle Mission," news release 05-230, 18 August 2005; NASA, "NASA Welcomes Space Shuttle Crew Back to Earth," news release 06-280, 17 July 2006; NASA, "NASA Welcomes Space Shuttle Crew Back to Earth," news release 06-321, 31 October 2006.
- 74 NASA, "NASA Approves Mission and Names Crew for Return to Hubble," news release 06-343, 31 October 2006; Marc Kaufman, "NASA Deciding Whether to Close a Window into Space," *Washington Post* (29 October 2006): A3. For background on the crew selection, see Massimino, *Spaceman*, pp. 257–267.
- 75 Griffin OHI, 22 May 2017, p. 7; Keith Cowing, "Why There Won't Be A Propulsion De-Orbit Module For Hubble (it is 'Idiotic');" NASA Watch, 31 October 2006, <http://nasawatch.com/archives/2006/10/why-there-wont-be-a-propulsion-de-orbit-module-for-hubble-it-is-idiotic.html#more> (accessed 8 July 2017).
- 76 NASA, "Hubble Space Telescope Begins 'Two-Gyro' Science Operations," news release 05-242, 31 August 2005; "STS-125 MCC Status Report #11," 16 May 2009; NASA, "NASA Updates Target Launch Date for Hubble Mission," news release 07-135, 7 June 2007; Kenneth Sembach, oral history interview with author, 25 May 2017, p. 6; Kimble OHI, pp. 10–14.
- 77 Transcription, Media Teleconference, "NASA to Discuss Hubble Anomaly and Servicing Mission Launch Delay" (Washington, DC: NASA Office of Public Affairs, 29 September 2008); Griffin comments during Hubble 25th Anniversary Panel, "SM4: The Last Servicing Mission to Hubble," 23 April 2017, recorded on DVD (Baltimore, MD, STScI).
- 78 Grunsfeld comment during Hubble 25th Anniversary Panel on SM4, *Ibid*.
- 79 NASA, "NASA Managers Delay Hubble Servicing Mission," news release 08-280, 30 October 2008; NASA, "NASA Sets Target Launch Date for Hubble Servicing Mission," news release 08-320, 4 December 2008; Frank Moring, Jr. and Guy Norris, "Transition Worries," *Aviation Week & Space Technology* (3 November 2008): 50; Dennis R. Jenkins, Jorge R. Frank, *Servicing the Hubble Space Telescope: Space Shuttle Atlantis—2009* (North

- Branch, MN: Specialty Press, 2009), pp. 52, 68–69; NASA Press Kit, *Space Shuttle Mission STS-125: The Final Visit to Hubble* (National Aeronautics and Space Administration, May 2009), pp. 1–16.
- 80 Frank Moring, Jr., “Delayed Certification,” *Aviation Week & Space Technology* (2 February 2009): 40. The Obama administration cancelled Ares in 2010.
- 81 Niedner OHI, p. 8.
- 82 Mission Control Center, Houston, TX, “STS-125 MCC Status Report #03,” 12 May 2009; “STS-125 MCC Status Report #04,” 13 May 2009; STS-125 Status Reports are archived at http://www.nasa.gov/mission_pages/shuttle/shuttlemissions/sts125/news/; Jenkins and Frank, *Servicing the Hubble Space Telescope*, pp. 76–78; NASA Press Kit, *Space Shuttle Mission 125*, 1–16. When STS-125 was scheduled to fly in October 2008, the designated crew for STS-400 was Dominic L. Gorie, Gregory H. Johnson, Robert L. Behnken, and Michael J. Foreman, who all had recently flown on the STS-123 mission.
- 83 William Harwood, “Spacewalk No. 1 Ends,” *Spaceflight Now* and CBS News “Space Place,” posted 14 May 2009, <http://www.spaceflightnow.com/shuttle/sts125/090514fd4/index6.html> (accessed 30 May 2016).
- 84 Villard OHI, 4 November 2016, p. 24.
- 85 Mission Control Center, Houston, TX, “STS-125 MCC Status Report #05,” 13 May 2009; “STS-125 MCC Status Report #07,” 14 May 2009; Harwood, “Spacewalk No. 1 ends,” NASA Press Kit, *Space Shuttle Mission 125*, pp. 73–76.
- 86 Mission Control Center, Houston, TX, “STS-125 MCC Status Report #09,” 15 May 2009; Patrick Crouse, oral history interviews by author, 17 June 2016, pp. 6–13; James Jeletic, 19 May 2017, pp. 7–8; Jim Jeletic, “Long Live Hubble,” *Air & Space Smithsonian* 33, no. 6 (December 2018/January 2019): 18, 20.
- 87 Mission Control Center, Houston, TX, “STS-125 MCC Status Report #11,” 16 May 2009.
- 88 Massimino, *Spaceman*, p. 289.
- 89 Dennis Overbye, “As Tasks at Hubble End, No Tears, But it Was Close,” *New York Times* (18 May 2009): A17; “STS-125 MCC Status Report #13,” 17 May 2009; Massimino, *Spaceman*, pp. 281–296; “STS-125 MCC Status Report #15,” 18 May 2009; “STS-125 MCC Status Report #17,” 19 May 2009; NASA Press Kit, *Space Shuttle Mission 125*, pp. 76–81; William Harwood, “Stripped Bolt Trips Up Hubble Instrument Repair,” *Spaceflight Now* and CBS News ‘Space Place,’ posted 17 May 2009, <http://www.spaceflightnow.com/shuttle/sts125/090517fd7/index3.html> (accessed 30 May 2016).
- 90 William Harwood, “Shuttle Atlantis Glides to Smooth California Landing,” *CNET*, posted 24 May 2009, <http://www.cnet.com/uk/news/shuttle-atlantis-glides-to-smooth-california-landing/> (accessed 31 May 2016); “STS-125 MCC Status Report #17,” 19 May 2009; “STS-125 MCC Status Report #21,” 21 May 2009; Jenkins and Frank, *Servicing the Hubble Space Telescope*, p. 114.
- 91 NASA, “Sen. Mikulski Unveils First Images from Rejuvenated Hubble,” news release 09-205, 9 September 2009.
- 92 O’Keefe OHI, 5 June 2017, p. 19.

- 93 Frank Moring, Jr., "Hubble Endgame," *Aviation Week and Space Technology* (14 January 2008): 26; Marc Kaufman, "One Last Trip to Open Hubble's Eyes Even Wider," *Washington Post* (7 July 2008): A5.
- 94 NASA, "NASA's Proud Space Shuttle Program Ends with Atlantis Landing," news release 11-240, 21 July 2011.
- 95 Sembach OHI, p. 6.



CHAPTER EIGHT

Operating the Hubble Space Telescope

▲ Visible-light data taken by Hubble's ACS and near-infrared exposures taken by the WFC3 were combined to create this view of cluster Westerlund 2. (NASA/ESA/Hubble Heritage Team [STScI/AURA]/A. Nota [ESA/STScI]/Westerlund 2 Science Team: heic1509a)

The Hubble Space Telescope is much more than a spacecraft in Earth orbit. HST requires thousands of people and a vast infrastructure on Earth to direct, support, process and interpret its work. This infrastructure ultimately reaches around the world in the form of astronomers who propose, perform, and use HST observations through the Space Telescope Science Institute, and it extends into space through the Tracking and Data Relay Satellite System (TDRSS) that keeps HST in touch with its control center at NASA's Goddard Space Flight Center. This chapter turns to Hubble's infrastructure on Earth, its role in HST operations, and the evolution of that infrastructure and the institutions that operated it, especially NASA Goddard and its contractors. HST is also a project of the European Space Agency, and this chapter will look at ESA's role in HST operations. STScI holds an important place in the story of HST as the organization responsible for HST science program management and science operations, and as a model for scientific oversight of space-based observatories that have followed HST. This chapter will discuss STScI's evolution as an institution, while the next chapter will cover its relationship to astronomy. Hubble's great capabilities and the ability to maintain and upgrade them over more than three decades of operations comes at a cost, however, and this chapter begins with a discussion of the monetary costs for HST and its infrastructure on Earth.

HST COSTS

The ongoing work of HST depends on money, most of it appropriated by Congress each year after it is debated and amended budgets have been drawn

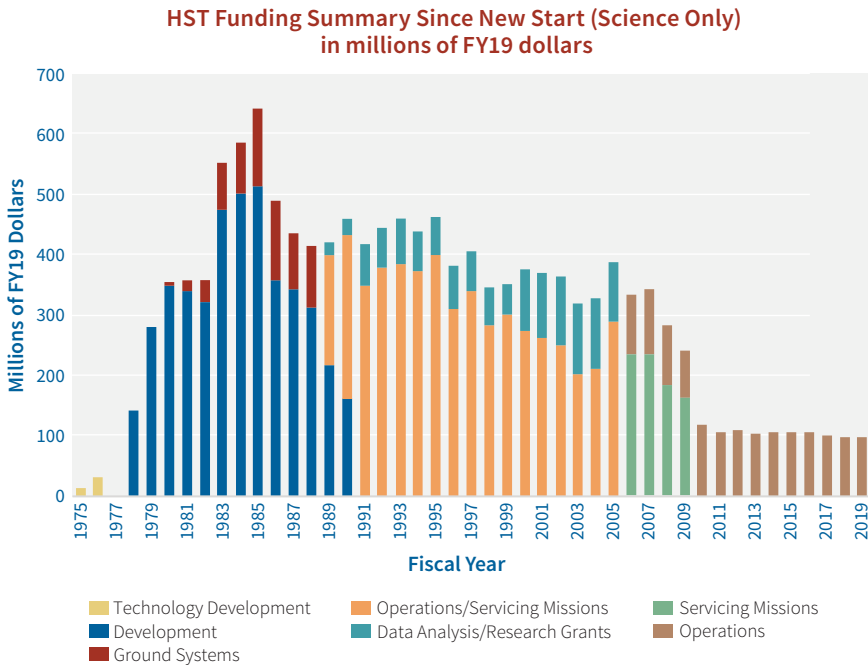
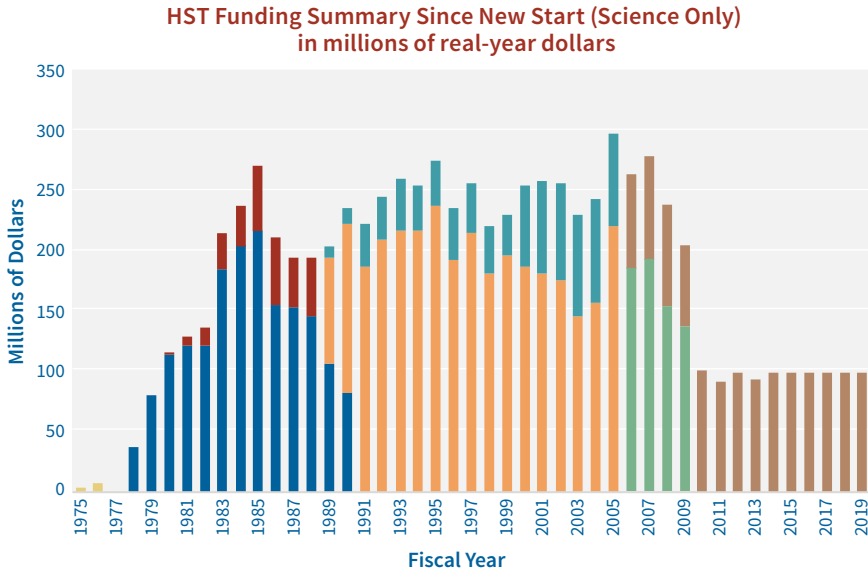

▲ Graph of HST funding since new start. Data are presented in appendix A. (Data courtesy of Craig Tupper, NASA Headquarters)

up by NASA and the White House Office of Management and Budget (OMB). HST's costs began with designing and developing HST and preparing it for launch. Historian Robert W. Smith estimated that by October 1986, NASA and ESA had spent \$1.6 billion, and by the time Hubble was launched in 1990, the costs totaled \$2 billion, plus the approximately \$250 million cost of its deployment mission. At the time of HST's launch in 1990, news media commonly used a figure of \$1.5 billion as Hubble's cost up to that point. All these figures are in the money of the time, and come close to the popular 1990 media estimates of HST's cost, which ranged between \$1.5 and \$2.1 billion.¹ After launch, operating costs and spending on new instruments for HST were charged to Hubble as part of NASA's space science budget, but most of the costs of the Space Shuttle deployment flight and the five servicing missions that followed were charged to NASA's human spaceflight budget.² During HST's first two decades, it required funding for both operations and development of new instruments and new equipment to go to HST during its five servicing missions. In the 1990s, HST annual spending for operations and instrument development (in 2019 dollars) was close to \$500 million a year early in the decade and fell below \$400 million near the end of the decade, likely as a result of various cost containment and efficiency measures, such as Vision 2000, which will be explained later in this chapter. HST spending continued to fall in the early 2000s to close to \$300 million a year, again in 2019 dollars. Once the last servicing mission was completed in 2009, HST funding no longer included the costs of preparing instruments and repairs for servicing missions, and annual spending fell to reflect that fact. Since then, HST spending has come in close to \$100 million a year. HST estimated spending in the 2019 fiscal year was \$98.3 million. In 2017, NASA Headquarters reported that spending on HST totaled \$13.7 billion in 2017 dollars. Those figures include the cost of hardware for servicing missions, but not the costs of the six shuttle missions associated with HST.³ Various numbers have been advanced for the cost of Shuttle servicing missions, running from \$450 million to \$1.6 billion in 2010. If the cost of each of these missions is around \$1 billion, that would add up to \$6 billion for the six HST Shuttle missions, raising the total price tag for Hubble and its operations to nearly \$20 billion as it neared its 30th anniversary on orbit.⁴

HST AND ESA

HST is not only a NASA program. It is also a program of the European Space Agency, a fact marked by the presence of the ESA logo next to the NASA logo atop HST. When NASA and ESA agreed in the 1970s to cooperate on the Space Telescope, the two agencies were also working together on the highly successful

International Ultraviolet Explorer satellite. They had ambitious plans for further scientific cooperation, including a cometary mission and the International Solar Polar Mission, but NASA pulled out of the former and reduced the latter from two to one spacecraft due to its budgetary and technical problems with the Shuttle. As for the Shuttle, the ESA provided Spacelab laboratory modules that flew in the Shuttle's payload bay, many of them crewed by ESA astronauts. While ESA faced budgetary problems of its own, it moved ahead using its own Ariane launch vehicles on ambitious missions, including the Giotto spacecraft that flew by Halley's Comet in 1986. HST became the "only ESA/NASA cooperative project, with ESA as a junior partner."⁵ For its part of the HST program, ESA supplied the Faint Object Camera and the first two sets of solar arrays, along with the solar array electronics and drive mechanisms that served them, which are discussed elsewhere in this book. ESA also supplied staff to STScI. In return, European astronomers were guaranteed a minimum of 15 percent of HST's observing time.⁶ Europe's participation in HST was also evident in the presence of ESA astronauts on two Shuttle servicing missions: Claude Nicollier on SM1, and Nicollier and Jean-François Clervoy on SM3A.

The guaranteed minimum of 15 percent of HST observing time agreed between NASA and ESA has not had to be invoked because European astronomers have regularly won an average of about 20 percent of Hubble observing time under the merit-based HST time allocation process. Before ESA staff was enlarged with the preparations for JWST, ESA was represented at STScI with 15 astronomers on staff, and many have made outsized contributions to STScI's work. Duccio Macchetto was ESA Project Scientist for HST through its early years and Principal Investigator for the FOC through its time on HST. At STScI, he rose to be associate director. Antonella Nota's career at the Institute began in the 1980s, and she became Associate Director at ESA and Head of the Science Mission at STScI. Helmut Jenkner joined STScI in 1983 and played a key role developing HST's Guide Star Catalog. Since 2002, he has served as deputy head of the Hubble Mission Office at the Institute, continuing after he retired from ESA service in 2014 and shifted to the employ of AURA. As outlined earlier, ESA astronomer Christopher Burrows played a key role in diagnosing and overcoming HST's spherical aberration problem.⁷

ESA teamed up with the European Southern Observatory to create the Space Telescope European Coordinating Facility (ST-ECF) at the ESO's headquarters in Garching, near Munich, in 1984. The facility assisted European astronomers who were making observations with HST, a function that was especially important before computers connected to STScI through the internet became available. The facility contained Europe's copy of the Hubble data



▲ European Southern Observatory Headquarters, Garching, Germany, home of the ESA Space Telescope European Coordinating Facility, photographed in 1998. (European Southern Observatory)

archive, and ESA staff worked with STScI to build up their archive and make use of new archival software. Improvements in computing power and networking over the years of HST operations meant that astronomers, including those based in Europe, required less assistance to prepare their observation proposals, so the facility changed its priorities to help astronomers better interpret their data. Astronomers at the facility also supported advances in the use of HST instruments, including creating “slitless spectroscopy” modes for Hubble instruments that allow analysis of fainter objects. In the 1990s, the facility exploited the rise of the internet and Hubble’s successes to begin producing outreach and HST public relations products of its own, focusing on the ESA’s spacetelescope.org website.⁸

ESA’s own budget issues have affected its participation in HST. The original 15 ESA astronomers at STScI made up about 15 percent of the Institute staff in STScI’s early days, but ESA resisted calls to increase its staff complement as the STScI staff grew in the 1990s. In anticipation of the removal of ESA’s Faint Object Camera from HST in 2002, NASA and ESA set up a working group to discuss a new European instrument for HST. Early in the process, the group identified two possible ESA instruments—both three-dimensional spectrographs—but ESA backed away from the plan due to budget cuts that followed a reorientation of the European space program decided at the ESA Ministerial Conference in Toulouse in October 1995.⁹ When NASA Administrator Sean

O’Keefe canceled Servicing Mission 4 in 2004, NASA did not consult ESA about the decision, but ESA officials worked “behind the scenes” to obtain the decision in 2006 from O’Keefe’s successor Michael Griffin to reinstate SM4.¹⁰

After 20 years of HST operations, ESA and the ESO closed the ST-ECF on 31 December 2010. Rudolf Albrecht, who earlier had directed the facility, called the closure a “hardnosed” budget decision, but noted that the ease of transferring large amounts of data anywhere on Earth meant that the original need for the facility had ended. In 2012, ESA moved the European HST archive to the European Space Astronomy Centre (ESAC) in Villanueva de la Cañada near Madrid, Spain, where ESA runs its solar system and astrophysics missions. In 2018, all the HST data products that are available from the MAST archive at STScI became available from the ESAC Data Centre as well as the Canadian Astronomy Data Centre.¹¹

Even as ESA began to reduce its role in HST by not replacing FOC, it was preparing its contribution to the James Webb Space Telescope, which included providing one of JWST’s four instruments, the optical bench of another instrument, an Ariane 5 launch vehicle to launch JWST, and additional support personnel for the program at STScI. A joint report by American and European scientists in 1994 stated that while some European astronomers felt that NASA did not always present HST as a cooperative venture in its outreach efforts, “[t]he cooperation on HST between U.S. and European Astronomers has worked very well.”¹² While Europe is participating in JWST, and the Canadian Space Agency has also decided to join the JWST partnership, it is possible those decisions may simply reflect the ESA’s and CSA’s desire to take part in the world-leading telescope project rather than good feelings about the partnership in HST.

NASA GODDARD

Like all NASA programs, including those involving other countries, the ultimate responsibility for HST resides at NASA Headquarters in Washington, DC. As recounted in chapter one, NASA chose the Marshall Space Flight Center in Huntsville, Alabama, as lead Center while the space telescope was being built. Marshall had project management responsibility for building the spacecraft and supervising the prime contractors, Lockheed and Perkin-Elmer. The Goddard Space Flight Center in Greenbelt, Maryland, was handed responsibility for HST’s scientific instruments and science program, ground systems, mission operations, and data reduction, which meant that Goddard assumed full responsibility for HST shortly after it was launched. Goddard’s history goes back to May 1959, six months after NASA was created, starting with personnel



▲ Steven Muller Building, Johns Hopkins University, Baltimore, Maryland, headquarters of STScI, photographed in 2015. (Christopher Gainor)

who had previously worked on the Vanguard satellite program for the Naval Research Laboratory, along with other laboratory personnel and Army Signal Corps researchers who were developing weather satellites. Goddard quickly grew into NASA's major Center for building spacecraft and technologies to study Earth and for space sciences. By its 40th anniversary in 1999, 11,000 people worked at Goddard, most of them contractor employees, and it was responsible for more than 200 scientific satellites covering every aspect of space science and Earth observation. From the beginning, Goddard was responsible for space physics and astronomy, and so it came to the job of controlling HST with a great deal of experience in the field.¹³

The HST Operations Project at Goddard has maintained a team of civil servant and contractor senior engineers and managers with responsibility for day-to-day HST operations. The HST Operations Project was led from the beginning by Ann C. Merwarth until she retired in 1998. Many of the people who supported Hubble's mission operations at Goddard worked under a contract with Lockheed Martin Space Systems. Personnel from other contractors and subcontractors also monitored HST systems, and also maintained and upgraded ground equipment used for Hubble operations. NASA and contractor employees were involved in the preparations for Hubble Servicing Missions, including preparing astronauts and equipment for the flights. Because the

engineers from NASA, Lockheed Martin, and other contractors worked side by side smoothly at Goddard, the groups were “embedded” in each other’s work, according to Deputy Project Manager James Jeletic, working together efficiently as a single team.¹⁴

HST science operations work was contracted out by the Project Office to the Association of Universities for Research in Astronomy, which operates the Space Telescope Science Institute in Baltimore, Maryland. While the HST Project Office oversees the work of the Institute under the terms of AURA’s contract with NASA, Goddard also has project scientists for HST on its own staff, representing the wider astronomical community inside NASA and providing scientific perspective to project management. The HST project scientists help maximize scientific return from Hubble and provide insight into the work done by the Institute. All of Goddard’s project scientists are working scientists who do their own research, and any observing time they get on HST goes through the time allocation process that all scientists must pass to obtain time on Hubble.¹⁵

Prior to launch, all science instruments bound for Hubble were processed and tested in the cleanrooms of Goddard. Before HST itself was launched, all the instruments and other equipment went from Goddard to be integrated into HST at Lockheed in Sunnyvale, California. Once HST was in space, new instruments went from Goddard for final launch processing at the Kennedy Space Center and placement inside the Shuttle for launch to HST on a servicing mission.¹⁶ Goddard was home to the HST Flight Systems and Servicing Project, which was run by Goddard engineer Frank Cepollina. This office developed many of the tools and procedures that were essential to the success of the Hubble Servicing Missions. Once its work with HST was completed in 2009, it shifted to satellite servicing work and became the Satellite Servicing Project Division in 2016, continuing to develop new methods of servicing and repairing satellites on orbit.¹⁷ Goddard also managed the Tracking and Data Relay Satellite System and its main ground station at the White Sands Complex in New Mexico and the Near Earth Network, a series of ground stations used by Hubble for emergency purposes.¹⁸ NASA’s Johnson Space Center and Kennedy Space Center were responsible for the preparation, launch, and operation of the Space Shuttle missions related to HST, including the STS-31 Hubble deployment mission in 1990, the five servicing missions that followed, and the STS-95 HST Orbital Systems Test (HOST) mission that tested hardware built at Goddard for installation on HST in servicing missions 3A and 3B.

Goddard’s preparations for HST operations began long before launch with the creation of the Space Telescope Operations Control Center (STOCC), and



▲ Image of the Space Telescope Operations Control Center (STOCC) at Goddard Space Flight Center in 1987. (NASA)

a number of different contractors built the control center and its systems. Ford Aerospace built the STOCC and also built and maintained control systems there until Loral AeroSys took over the work in 1990 when Ford was sold to Loral. The new control center contained eight mainframe computers and associated software. The control center used Preliminary Operations Requirements and Test Support (PORTS) hardware and software that joined the control center to NASA communications networks and to STScI. The center used mainframe VAX computer systems and control stations built by the Digital Equipment Corporation (DEC) with full redundancy to protect against failures. Computer Sciences Corporation delivered HST mission planning and mission scheduling software. The completed STOCC was dedicated on 14 February 1984, at a time when HST was scheduled to be launched in 1986. Lockheed personnel staffed the original control center in Goddard's Building 3 under the Mission Operations Contract it signed in 1980 with NASA. NASA upgraded the DEC computers and workstations of the PORTS systems in 1988. The Goddard HST team was led by Project Manager Frank Carr from 1983 until James V. Moore took over in 1988.¹⁹

STAR CATALOG

STScI also had many responsibilities to fulfill before launch to make HST operations possible. One important task was preparing a catalog of guide stars to help accurately aim the telescope because no existing star catalog had sufficient numbers of faint stars. The Institute also had to establish usage schedules for the telescope. Since HST was in such a low orbit that targets would only be available for part of each 95-minute circuit of Earth, setting schedules became an intricate process involving both the Institute and the engineers and scientists at Goddard.²⁰

When STScI astronomers first began to think about how to find guide stars to aim HST, they considered having a staff on the ground measure sky survey glass plates while preparing and scheduling individual observations for HST. They would then uplink the information on guide stars to HST. In the words of STScI Director Riccardo Giacconi, “this was a scheme doomed to failure.”²¹ The best star survey of the time, the Smithsonian Astrophysical Observatory (SAO) star catalog, included stars as dim as ninth magnitude and provided an average six stars per square degree of sky. Because the space telescope’s fine guidance sensors had very limited fields of view, they required 100 stars per square degree to point HST. Therefore, HST required a new star catalog that included 15th magnitude stars, roughly 4,000 times dimmer than what can be seen with the naked eye (Stars with higher magnitudes are dimmer than other stars, and the brightest stars have negative magnitudes. For example, the brightest star in the sky, Sirius, has an apparent magnitude of -1.46). The guide stars used for HST also had to be based on recent observations because most stars move relative to other stars as seen from Earth. While their movements are imperceptible to human observers, the tolerances of HST’s sensors were so fine that



▲ Riccardo Giacconi (1931–2018), the first director of STScI. (STScI)

the stellar movements would become a problem after just a few years. So STScI and Caltech began a new sky survey using two telescopes specially designed to image wide areas of the sky, the Samuel Oschin Schmidt Telescope at Mount Palomar and the UK Schmidt Telescope in Siding Spring, Australia. The telescopes were used to produce 1,477 sky survey plates covering the entire celestial sphere, and converting them into useful data for the catalog proved to be a daunting task involving both the latest in computing technology and what one participant called “astronomy on a production line basis.”²² Each photographic plate underwent a quality control inspection before being digitized in one of two modified Perkin-Elmer scanning microdensitometers, a process that took 12 hours per plate. Once the plates were available, scanning them all took three years. The digital information captured from each plate, about one gigabyte of data, approximately the equivalent of an hour of high-definition video, was then processed to verify, isolate and inventory each celestial object, assign coordinates, and separate stellar objects that could be used as guide stars from nonstellar objects such as galaxies. The resulting HST Guide Star Catalog contained 18,819,291 objects, including 3,649,418 nonstellar objects, providing 60 times as many stars as in the SAO Star Catalog. In addition to the time needed to scan the photographic plates, writing 200,000 lines of computer code to create the catalog took another four years. In total, the project took eight years to complete. Giacconi wrote that had HST been launched in 1986, the catalog would have covered only part of the sky, but the launch delay allowed a “hurried” scan of all the plates.²³

The new HST Guide Star Catalog was published in 1989, a time when digital technologies were coming to the fore, but the internet was still in extremely limited use and had very limited technical capacity. The catalog was made available on a pair of CD-ROMs (Compact Disc—Read Only Memory). STScI distributed the CD-ROMs to professional astronomy institutions and, with help from the Astronomical Society of the Pacific (ASP), sold them to amateur astronomers and anyone else who wanted the data. Images of all the plate scans were also digitized and made available to astronomers, and STScI created software to help astronomers using the catalog plan their observations.²⁴ In 1994, the STScI and the ASP issued a 102-CD set called the Digitized Sky Survey (DSS). The survey contained, in a slightly compressed form, the scanned images used to create the original Guide Star Catalog covering the entire sky. A compressed version on eight CD-ROMS known as RealSky became available in 1996.²⁵

The original HST Guide Star Catalog was only a first draft. Because of the stellar motions noted previously, more than 10 percent of guide star acquisitions would fail due to stars moving out of position within HST’s estimated 15-year

lifetime. So in 1989, STScI began scanning National Geographic Society-Palomar Observatory Sky Survey plates from the 1950s to provide information on the proper motions of catalog stars when compared with the data from the first HST Guide Star Catalog. The sky was rephotographed from Palomar and the Anglo-Australian Observatory in Australia. The result was *Guide Star Catalog II*, which included stars as dim as 19th magnitude, this time in color, providing more information. The new catalog contained data on nearly half a billion stars—20 times as many as the original HST catalog—and was released in 2001. It was dedicated to the memory of Barry M. Lasker, who was one of the founding scientists of STScI and had led the Guide Star Catalog and Digital Sky Survey projects prior to his death in 1999. Conrad R. Sturch and Brian J. McLean of STScI also played leading roles in creating these projects. An augmented version of the catalog with nearly a billion objects was issued in 2007. This latest release, which required seven years of work that included digitizing 4,400 plates, was carried out by astronomers at STScI and the Osservatorio Astronomico di Torino in Italy.²⁶

EXTRA TIME TO PREPARE

The Challenger disaster in 1986 bought valuable time for NASA, STScI, and other contractors to deal with various problems with Hubble and prepare for operations after the postponed HST launch. This was underlined in an STScI report in 1987, which said that had HST operations begun with the planned launch in October 1986, “we would have done so with a great many restrictions, both in terms of efficiency and functional capability imposed by the limitations of the ground system.”²⁷ The launch delays gave the Institute time to deal with ongoing problems with HST’s Science Operations Ground System (SOGS). NASA had let a contract with TRW in 1981 to create this system while STScI was just getting started. From its earliest days, STScI expressed many concerns with the system, and the Institute found major problems with SOGS, including inadequate ability to track planets. An Institute team led by astronomer Rodger Doxsey worked with contractor and NASA personnel in the late 1980s to make the system usable.²⁸

During the extra time before launch, Hubble’s control systems underwent a number of tests, including prelaunch simulations of HST operations with the spacecraft located where it was built at Lockheed in Sunnyvale, California, and its controllers in their places in the STOCC at Goddard. A major test in the summer of 1986 with Hubble in a vacuum chamber showed that HST’s power system needed upgrading, particularly its solar cells and batteries. The Ground System 4 test in June 1988 included ground systems connected to HST

in its clean room at Lockheed to simulate nearly a full week of HST operations. Although HST's science computer went into a safe mode during the fourth day of operations, the test was considered a success because controllers were able to bring HST out of safe mode. Other tests involved the STOC showing that it could support mission operations and STScI demonstrating its capability to support science operations using HST's scientific instruments.²⁹ A team of NASA and contractor experts worked to reduce problems HST's Fine Guidance Sensors had acquiring guide stars. Further tests of HST and its ground systems in 1988 and 1989 raised confidence in both the spacecraft and its onboard systems and identified problems to be solved before launch.³⁰

The fact that more time was needed to make HST's Guide Star Catalog, Science Operations Ground System, and many systems on board the spacecraft ready for flight shows that NASA had underestimated the complexity of operating the Hubble Space Telescope, which was much bigger and far more complicated than any previous space telescope. STScI represented a new way of conducting scientific operations for NASA, based on the belief of many scientists that they needed to operate outside of the direct control NASA had exercised on previous missions. NASA's differences with STScI during the 1980s could also be explained by the tight budgets and challenging schedules that the space Agency had to live with. As explained in chapter one, Goddard and STScI disagreed over the size and role of the Institute. These disagreements cropped up one more time in 1989 when a NASA Inspector General audit report examining the impacts of Shuttle launch delays found that the Institute had maintained its staff levels during the delays to prevent losing highly qualified employees, and Goddard increased its oversight of STScI's performance in response to the report's recommendations. Although this increased oversight didn't sit well with the Institute, by the time HST was launched, Goddard and STScI had largely agreed on their respective roles.³¹

By then, it was clear that the Institute itself had to be much bigger than earlier thought to do its job serving astronomers using HST and also as a research institute in its own right. As HST operations began in 1990, STScI had a budget of about \$29.4 million and a staff of 390 people, representing major growth over the previous years and much bigger than the launch time staff of 89 people projected by the 1976 Hornig report, considered the founding document of the Space Telescope Science Institute. The Hornig report had called for a skilled institute staff of astronomers to perform service functions for the space telescope and those using it, a staff that would carry out its own "first rate research," and explained that a permanent scientific staff whose members used HST would be "highly motivated" to ensure that the instruments would be well

maintained and as powerful and efficient as possible.³² The role of the scientific staff at STScI could be compared to academics at universities who combine their research with teaching. Generally, scientific staff at STScI spend 80 percent of their time on functional tasks and 20 percent on research, but some higher ranking scientists divide their research and functional work on a 50-50 basis. Others were specialists charged with engineering Hubble's instruments or maintaining and designing the computer systems necessary for HST's work. Public affairs and education specialists brought Hubble's work to the public and to students. Administrative staff supported the Institute's programs. When the launch of HST approached, STScI had to reorganize to prepare for operations. Those changes began in 1988, when the launch was anticipated to take place in 1989. That year the observing proposals for the first cycle of observations went through the first Time Allocation Process for HST, which will be covered in detail in the next chapter.³³

HST OPERATIONS BEGIN

When HST was finally activated in Discovery's payload bay during the April 1990 deployment mission, it came under the control of the STOCC at NASA Goddard. In the early months of operations, Marshall and Goddard engineers worked together to commission the spacecraft. On 1 October, Goddard took full operational responsibility for Hubble, and the remaining Marshall personnel returned to Huntsville and new assignments. In the early months, Lockheed personnel from Sunnyvale also took active roles in monitoring HST and troubleshooting problems.³⁴

For regular Hubble operations, the Flight Operations Team in the STOCC at Goddard issues all the commands to HST, including the pointing and instrument commands developed at STScI. The Institute develops weekly schedules for observations that allow for safe and efficient operation of the telescope, including selection of guide stars. In the early days of flight, personnel in the STOCC coordinated scientific and engineering schedules before translating them into detailed instructions for HST and its instruments, but this function was later shifted to the Institute. The uplinks include daily command loads from the STOCC to HST's main onboard computer through the TDRSS ground terminal at White Sands, New Mexico. Science data are stored on recorders aboard HST and then downlinked to Goddard through TDRSS along with data on the health of HST systems. The science data are then sent to STScI for processing and calibration before being released to the scientists who have requested the observations, as well as being deposited in the HST data archive.

Like other control centers at NASA, the STOCC is far more than a single room. Goddard's HST operations team monitors telemetry sent by Hubble for performance of spacecraft systems and subsystems, examines it for changes or anomalies, and addresses problems as necessary. When HST operations began, the STOCC included the Mission Operations Room, System Engineering and Evaluation Room, Mission Support Room, and Engineering Support System. In the early years of HST operations, the STOCC operated every day around the clock, and the Data Operations Control (DOC) room downstairs from the main Mission Operations Room contained computers, communication equipment, and human operators until automation and miniaturization led to changes. The Mission Operations Room contained the displays and workstations needed to follow spacecraft operations and send commands to HST. Prior to the first servicing mission, the Servicing Mission Operations Room was added for simulations and other preparations for servicing missions, and was also available for use during routine HST operations and for the diagnosis of in-orbit anomalies. The original operations rooms also included Observation Support System (OSS) consoles staffed by STScI personnel. The System Engineering and Evaluation Room could be used both for routine operations and to run simulated subsystem and software tests. Further support work was done in the Mission Support Room and with the help of the Engineering Support System. Johnson Space

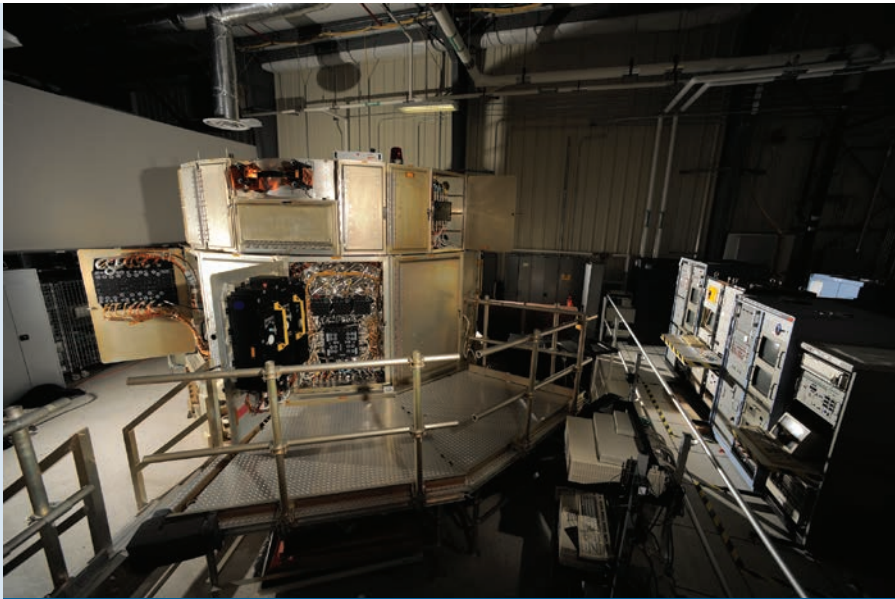

▲ Vehicle Electrical Systems Test (VEST) facility at Goddard Space Flight Center. (NASA/Pat Izzo)

Center flight controllers often referred to the STOCC as the HST Payload Operations Control Center (POCC) during servicing missions.³⁵

The Flight Software team prepared software for use on board HST's computer, and this software was tested in the Vehicle Electrical System Test (VEST) facility, which replicated the electrical and computer systems on board HST. VEST was built at the beginning of HST's mission in 1990, played a key role in preparations for the servicing missions, and has continued to operate. For the first two decades of HST's mission, the VEST was located in Goddard's large cleanroom because flight hardware was tested in VEST before going to HST on a servicing mission. It was later moved to another location at Goddard.³⁶

HST requires regular daily contact with the ground through the TDRSS satellites to relay data in both directions. Some of the controllers' work included uplinking command loads daily for science mission schedules, a daily uplink to the spacecraft computer, and regular payload commands. Science data are "dumped" from recorders onboard HST through TDRSS to the ground each day, along with a daily "dump" of engineering data. There are also operations performed weekly, such as processing science operations schedules and updating network schedule changes. Other control operations include software updates, testing those updates, and maintaining and reconditioning equipment such as the gyroscopes, tape recorders, and computers.³⁷

The controllers and engineers at Goddard were often challenged during HST's early months on orbit with problems such as the solar array jitters outlined in chapter two and frequent safing events when HST would halt operations while controllers dealt with malfunctions in HST's computers, electrical systems, and instruments caused by cosmic ray strikes or by high energy particles in a region of the Van Allen radiation belts known as the South Atlantic Anomaly. While this problem was anticipated before HST's launch, particles from the anomaly caused spurious memory changes in HST's Fine Guidance Sensors. Conditions in the South Atlantic Anomaly required controllers to develop special procedures, software changes and reduced HST operations when it flew through this area. In the early days, HST also had problems acquiring guide stars, and controllers had to work to understand and manage the many quirks of the systems in the highly complex spacecraft. While these problems became better understood and more manageable as HST spent more time on orbit, other problems such as the deterioration of HST's gyroscopes and other systems have continued to challenge controllers.³⁸

Hubble's on-board computer was updated during its time on orbit, starting in 1993 when Servicing Mission 1 astronauts installed an 80386 co-processor on HST's DF-224 computer. Prior to that mission, Loral installed new and much

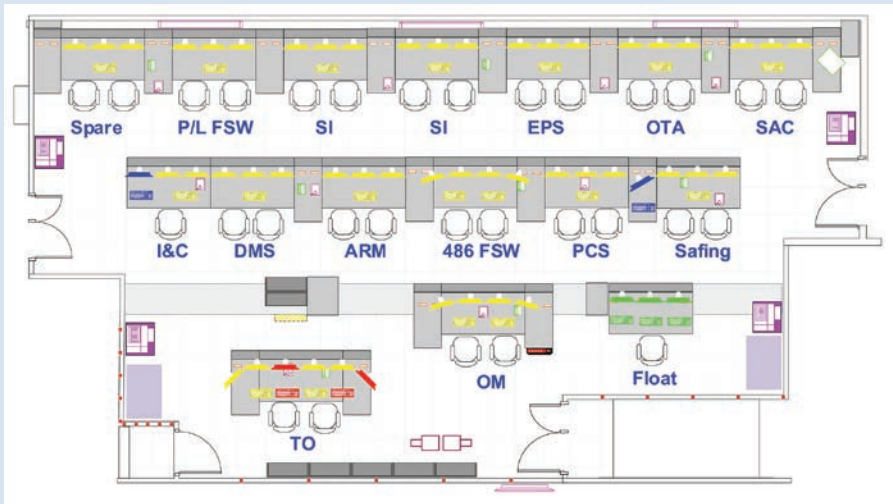
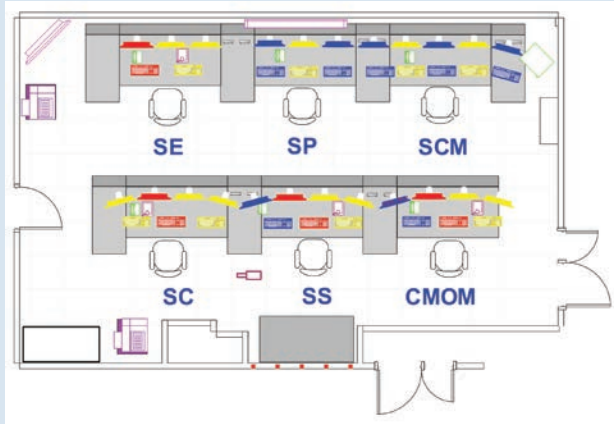

▲ Diagram/floor chart of Space Telescope Operations Control Center at Goddard in 2019.
(NASA Goddard)

faster DEC computer systems in the STOCC in what was known as PRS or the PORTS Refurbishment System, which took advantage of advances in computers and also worked better with the upgraded HST computer. When an Intel i486 computer was installed on HST in 1999 in Servicing Mission 3A, the HST Project created a laboratory known as the 486 Lab to prepare and test uploads to the new HST computer. Another change in HST operations at NASA Goddard once HST began operations involved NASA's contractual relationship with Lockheed. NASA and Lockheed signed the first Mission Operations Software and Engineering Support (MOSES) contract that took effect in 1992. MOSES brought together the Lockheed team members who had worked at Goddard

from the beginning of HST with Lockheed employees who had worked at Sunnyvale and transferred to Goddard after HST operations began.³⁹

OPERATIONS AT STSCI

The long delayed launch of HST and the completion of the commissioning period for Hubble meant big changes in the relationship between NASA Goddard and the Space Telescope Science Institute. Goddard and STScI began to get along better simply because HST was finally operating, and the myriad problems that afflicted HST in its early months on orbit compelled everyone involved to focus on solving those problems. On the Goddard side, when Joe Rothenberg became HST Program Manager and Associate Director for HST in 1990 to oversee NASA's response to spherical aberration, he set out to improve Goddard's relationship with STScI. Goddard's assumption of full responsibility for HST on the NASA side when Marshall left the program, simplified relationships with Institute personnel, and contributed to better relations. On the Institute side, the early 1990s were a period of transition as its work moved from preparing systems for operations to actually using them. Astronomers at STScI were able to use HST for their work as they had long hoped to do, albeit with the limitations imposed by the telescope's spherical aberration. The improvement in relations between NASA and STScI was symbolized by the contract between NASA and the Institute's parent body, AURA. NASA's initial contract for STScI with AURA ran through the first two years after HST's launch. Early in 1991, NASA and AURA began talks to renew the contract for five years and successfully reached agreement the following year.⁴⁰

Communications between scientists at STScI and engineers at Goddard involved many channels outside of the project scientists and managers at Goddard, and leaders of the Institute. Like elsewhere in the scientific world and academia, HST scientists serve on many committees, including the Space Telescope Advisory Committee (STAC), which advises both NASA and STScI, and many Institute committees, including the Space Telescope User Committee and the Space Telescope Institute Council, help direct the Institute and its work on HST. Under the terms of its contract with NASA, AURA established the Space Telescope Institute Visiting Committee made up of experts with no direct connection to AURA to provide a "peer review" of STScI, although the committee is known to advocate for the Institute.⁴¹

In 1992, there was a major change at the top of STScI. Riccardo Giacconi, the Institute's founding director, had agreed in 1991 to remain for a third five-year term, but he and his wife were dealing with the loss of their son in an automobile accident in Baltimore around that time. Giacconi came to realize

that the passion he had for his job “had been reduced to cinders,”⁴² and so when he was approached to take the top job at the European Southern Observatory, he accepted the offer and left STScI at the end of 1992. As the director who got STScI through its tumultuous first decade, Giacconi has remained a revered figure at the Institute. While many at NASA did not share that sentiment, David Leckrone, the longtime NASA HST Senior Project Scientist who had opposed Giacconi’s appointment and frequently differed with him while Giacconi sought to enlarge STScI’s powers, came to see Giacconi’s virtues, especially his work rallying Institute staff to help NASA solve the spherical aberration problem rather than to seek scapegoats.⁴³

Peter Stockman served as acting Institute director until August 1993, when Robert E. Williams, who moved to the Institute from his job as director of the Cerro Tololo Inter-American Observatory in Chile, took over. The new director was a known quantity to AURA since it also operated Cerro Tololo. Although Williams said he had a “collaborative style,” the new director showed that he was not afraid to make tough calls, such as the “Hubble Deep Field.”⁴⁴ Williams became director shortly before the first HST servicing mission that so dramatically improved HST operations, but he soon had to deal with a series of NASA budget cuts. STScI’s staff and budget had grown noticeably since 1990, and to deal with the budget cuts, the Institute underwent a strategic planning exercise and reorganization as part of an effort to streamline its work and take advantage of the changes that came with HST being in full operational mode. As the Hubble Program, STScI, and NASA in general coped with budgetary restraint in the early and mid-1990s, Williams was faced with cutting about 60 Institute staff out of 450, along with the services they delivered. Funds used to support observers were also reduced.⁴⁵

NASA and STScI have faced continual budget issues through HST’s lifetime as the federal government has struggled with one set of budget problems after another. This issue was hardly new because tight federal budgets had also strongly affected Hubble’s development process before launch.⁴⁶ Politicians in Washington had cut back many government programs to deal with public concern over the growing federal deficit in the 1980s and much of the 1990s, and the end of the Cold War in 1989 led to reductions in defense and other government spending.⁴⁷ Even after the success of SM1, Hubble’s high profile made it an irresistible target for budget cutters at the Office of Management and Budget and NASA as the Agency faced budget reductions and growing monetary demands to maintain the Space Station Program. Daniel Goldin, NASA’s Administrator through much of the 1990s, chafed at the cost of HST even as he reveled in its successes. HST had a powerful protector in Congress during its

first quarter century of operations in the person of Senator Barbara Mikulski of Maryland. Scientists belonging to STScI's Institute Visiting Committee warned in 1995 amidst the budget cuts that hit the Institute that these budget and staff cuts reflected "the only moderately developed ability of the political establishment to evaluate the importance of basic research for the long-range health of the nation," which it said, "have induced major threats to this most successful program."⁴⁸ The committee's dramatic language probably also reflected the scientists' concerns about events that took place outside the Hubble Program. In 1993, Congress decided to cancel the Superconducting Super Collider in Texas, a flagship project for particle physics, after \$2 billion had already been invested in it. The same year, Congress came within one vote of cancelling NASA's Space Station Program, the Agency's major human spaceflight program of the time alongside the Shuttle.⁴⁹

INCREASING EFFICIENCIES

Both Goddard and STScI responded to the budget reductions by making HST operations more efficient. Shortly after the success of SMI, Rothenberg moved on to higher positions in NASA, including Director of the Goddard Space Flight Center and Associate Administrator for Space Flight, and later, work in the private sector. John H. Campbell succeeded him as HST Program Manager after having served as deputy manager, and he worked to increase efficiency with help from managers like Frank Cepollina and Ann Merwarth. Campbell recalled that although all his spending had to be justified, "[w]e were never shortchanged."⁵⁰ In 1995, Goddard launched a five-year effort known as Vision 2000, which was aimed at reducing maintenance and operations costs by modernizing and automating the ground system activities related to HST, including observation planning, instrument operation, and data processing. Vision 2000 was spearheaded by the HST Operations Project team at Goddard led by Ann Merwarth and Preston Burch with strong support from STScI, which had already launched



▲ HST Program Manager John Campbell.
(NASA)



▲ Hubble Program Manager Preston Burch, speaks during a press conference in 2009. (NASA/
Paul. E. Alers: 200904230003HQ)

a continuous process improvement initiative for user support and observation scheduling called the Project to Re-Engineer Space Telescope Observing (PRESTO). These efforts built on advances in computer equipment and software on the ground that led to the installation of the Control Center System facilities and procedures into the Goddard control facilities and test facilities. This work started in 1997 with servers made first by Silicon Graphics Inc., then Sun and later Oracle, along with personal computer workstations. The more powerful 486 computer installed on HST in 1999 also required the HST control team to rewrite HST's computer code, which was a major effort that also affected ground-based computing and computing systems.⁵¹

HST project staff at Goddard also worked with Institute staff to raise HST's observing efficiency, which allowed more observations to be made in a given time. Early on, HST had a low observing efficiency rate, but in 1993, its controllers at Goddard and STScI increased observing efficiency from 33 to 42 percent. Observing time on Hubble was limited by a number of factors, starting with the fact that HST was in a low-Earth orbit that usually but not always meant that Earth passed between the target object and HST for roughly half of each 95-minute orbit. Some targets near the south and north poles of HST's orbits lie in what is known as the Continuous Viewing Zone and were thus within sight of HST for entire orbits. The best-known observation that made use of this zone was the area in Ursa Major chosen for the Hubble Deep Field

observations in late 1995. HST could not make observations when it passed through the South Atlantic Anomaly. PRESTO and Vision 2000 improvements reduced time lost due to scheduling problems involving movement of the telescope from one target to another, or calibrations and instrument preparations that can tie up telescope time. By 1995, some quarter years saw efficiency rise above 50 percent. STScI reckoned in 1998 that the average observing efficiency for a single instrument was about 55 percent. Two other measures have increased HST's efficiency: the use of parallel observations, using more than one instrument at the same time; and snapshot observations that make use of short periods of time between longer observations.⁵²

CONTROLLING CHANGES

In 2000, Campbell moved from HST to be Director of Flight Programs and Projects at Goddard, and later became manager of the NASA Wallops Flight Facility. Dave Scheve served as interim program manager until Preston Burch became HST Program Manager in 2001. Burch was an engineer and manager who had worked in private industry on the Apollo Lunar Module, the Orbiting Astronomical Observatories, and the Compton Gamma Ray Observatory before joining NASA Goddard, where he first served as Deputy Project Manager for HST Operations and in 1998 became Project Manager for operations.⁵³

One major but temporary change in the control setup for HST took place starting in October 2000, when HST flight operations moved from the STOCC to a new control room in STScI in Baltimore. Control remained there until 2006 when it was returned to Goddard. This shift originated when NASA tried to cut costs by streamlining its tracking and communications operations across the Agency into a single organization, the Space Operations and Management Office (SOMO) based at Johnson Space Center, along with a single Consolidated Space Operations Contract (CSOC), which was awarded to Lockheed Martin in 1998. NASA's ambitious plans for SOMO and CSOC ended with SOMO being disbanded in 2001, and in 2004 CSOC was not renewed. Hubble project management at Goddard concluded that bringing HST operations under SOMO, complete with a major budget reduction, would do serious harm to Hubble. Since tracking and control operations run by academic institutions such as the Institute were exempt from SOMO, the HST project moved HST control operations to STScI, where NASA arranged to build a new control room. Burch said that while there were benefits to having HST control functions located at STScI, this also divided controllers from the engineers who worked on HST at Goddard. Security became a larger concern after the terrorist attacks against the United States on 11 September 2001, and Goddard was

more secure than STScI. When SOMO and CSOC came to an end, the HST Project returned the control functions for HST to their traditional home in the STOCC at Goddard on 6 February 2006.⁵⁴

A new set of changes wasn't long in coming to the STOCC, however. The completion of SM4 in 2009 meant that HST had become like most robotic spacecraft in that there was no longer a means to physically repair malfunctioning or failing systems. Ground controllers and their computers and simulators became the only means of dealing with any problems that might arise. At the time, the Flight Operations Team working in the STOCC worked on a rotating shift schedule covering operations 24 hours a day, seven days a week. Four Observatory Controllers worked on HST operations each shift while another two controllers in the Data Operations Center monitored ground system health and status, including more than 100 separate hardware components. Well before SM4 in late 2006, budget projections showed that the servicing mission would be followed by major staff reductions that would go beyond the loss of people who prepared for servicing missions to include those who operated HST and maintained its ground support. The HST Project set up a team to prepare for operations using fewer spacecraft engineers and ground system personnel by automating HST operations to a far greater degree than before.⁵⁵

The result of the team's work was the biggest permanent change to the STOCC in HST's lifetime with the installation of a new automated ground system that began operating on 13 June 2011. The new system meant that HST began performing essentially all routine functions autonomously, and the STOCC from that point on was regularly staffed only from 8 a.m. to 4 p.m., five days a week, reducing the number of controllers from 21 to seven. When an anomaly occurred, STOCC personnel were alerted through their smartphones, and if necessary, they could come in to the STOCC to address problems since commands could not be issued from remote locations. New equipment such as the Automated Command Engine uplinked commands to HST, played back science data, and alerted members of the operations team of any problems. The Key Monitor System followed more than 4,000 telemetry items and alerted spacecraft engineers of problems. Many of the personnel reductions related to the new system were met through attrition, and those who remained found that their jobs became more fulfilling because they could concentrate more on solving problems, according to Larry Dunham, one of the top engineers working on HST at Goddard. "I think the flight ops people who were worried about being pulled from their consoles actually enjoyed becoming mission engineers and being able to spend time looking at data to help analyze them."⁵⁶ The remote capabilities of the HST ground system proved useful when the



▲ Space Telescope Operations Control Center during STS-125 servicing mission on 13 May 2009. (NASA/Pat Izzo)

COVID-19 pandemic struck the United States. Along with other NASA, government and other facilities, mandatory telework from home was put in place starting in March 2020 for personnel at Goddard, including HST controllers, during the pandemic.⁵⁷

NASA made other changes to the control center to reflect the fact that no more servicing missions would take place. The STOCC henceforth consisted of the Mission Operations Room, which continued as the main control room for HST, and the Operations Support Room, where personnel supported operations and worked with simulators to test updates and configuration changes. The changes also affected program management. After having overseen the HST Program during the final two servicing missions, Burch stepped down as HST Program Manager in 2010 and became the Program Manager of the NASA Joint Polar Satellite System. Up to that time, the HST Program Manager supervised the operations group, which included the control functions, and the hardware group, which was responsible for developing new instruments and preparing for servicing missions. With the end of servicing missions in 2009, the HST Project Office encompassed only the operations group as the hardware group separated from HST and became the Satellite Servicing Office. The head of the operations group, Mansoor Ahmed, moved to be Associate Director of Goddard's Astrophysics Projects Division, and Patrick Crouse, who

had long experience at Goddard working in space mission operations, became HST Operations Project Manager.⁵⁸

After the last servicing mission in 2009, mechanical problems that cropped up on HST had to be solved without the ability to make physical changes to the spacecraft. Engineers and scientists at Goddard and STScI worked together to deal with specific problems that cropped up during that time, such as HST's gyros. While Hubble was originally designed to operate with a minimum of three of its six gyroscopes, the HST Project at Goddard set up a Two Gyro Science Mode Operations Working Group to draw up procedures, flight software, and ground software using new control system algorithms to ensure that HST would continue to deliver scientific returns with only two operating gyros, which HST had done when gyros failed before SM4 in 2009. The HST Project had already begun a Life Extension Initiatives program to extend HST's mission life and increase its efficiency to maximize its scientific output in 2004 when SM4 had been cancelled. This program continued preparations for two-gyro operation of HST and even for operations with only one gyro operating. In that case, HST would not be able to follow moving targets such as solar system objects. The program also developed procedures for other HST systems that showed indications that they might fail, have limited lifetimes, or develop an anomalous condition, such as the Fine Guidance Sensors, solar panels, onboard computers and memory, recorders, and transmitters.⁵⁹

SPINOFFS

Like many other NASA programs, the work of building and maintaining HST has advanced technologies that could be applied to other purposes, often involving new products and processes. Probably HST's most important role in advancing technology involved its early adoption of the charge-coupled device for use in astrophotography, which helped drive a technology that has revolutionized astronomy.⁶⁰ As mentioned earlier in this chapter, STScI made the Guide Star Catalog used with HST's Fine Guidance Sensors available in digital form for use by professional and amateur astronomers. The catalog is now packaged with software used widely by amateur astronomers to plan and control their observations.⁶¹ HST's advances to CCDs have also helped advance medical imaging including mammography.⁶² Computer software developed to streamline NASA Goddard control functions for HST as part of Vision 2000 was incorporated into the Globalstar satellite telephone system.⁶³ An algorithm used by HST to track and compare star fields with its own databases has been used by biologists to follow the movements of whale sharks.⁶⁴ HST imaging and software advances have also been applied in health care. For example, a member of the team

that developed scheduling software for HST created software called On-Cue to help hospitals deal with their ever-changing scheduling challenges.⁶⁵ NASA also worked to facilitate commercial use of technologies such as the precision power tools that astronauts used to repair HST, and NASA Goddard signed a patent license with an engineering firm to manufacture a high-speed data processor known as SpaceCube developed for use in SM4.⁶⁶

STORMS IN BALTIMORE

Through the first seven years of HST operations, the future of STScI had been tied to HST. Its cooperation with Goddard had helped make the first two HST servicing missions a success, and the Institute received high marks in its annual contract assessments from NASA. In 1997, NASA renewed its contract with STScI for the second time for five years into 2002.⁶⁷ But the Institute's successes didn't obscure the fact that HST was entering the second half of its planned 15-year lifetime, causing the leaders of STScI to become increasingly preoccupied with the Institute's future beyond Hubble. In June 1998, NASA designated STScI as the science and operations center for the Next Generation Space Telescope, later renamed the James Webb Space Telescope. The Institute Visiting Committee wrote that this decision caused a "significant improvement in the future prospects of the Institute," giving STScI "a new avenue for intellectual growth, in essence one that will forestall institutional stagnation."⁶⁸ This need for new projects was felt acutely at STScI, since a strengthening U.S. economy at the time meant the Institute faced challenges competing for skilled staff, amidst continued pressure from NASA to reduce HST's operational costs. By the time STScI won its role with JWST, the Institute was in the midst of a leadership transition. Although he had been offered a second term as STScI director, Robert Williams decided to step down so that he could focus on his own scientific research. AURA named Steven V. W. Beckwith as the Institute's third director, effective 1 September 1998. He was an astronomer educated at Cornell and Caltech, and in 1997 he was director of the Max-Planck-Institut für Astronomie in Heidelberg, Germany. Beckwith reorganized STScI in 1999 to better support operating two major missions. On 3 January 2000, the Institute's new structure came into effect, complete with a Missions Directorate containing a Hubble Division, another division for JWST, and a third for the Institute archive, which was growing in size and importance.⁶⁹

Although the early years of Hubble's second decade on orbit went well in terms of scientific production, public image and upgrading HST's instruments, tension grew between the Institute and NASA. The Visiting Committee reported in 2003 that STScI's parent institution, AURA, and NASA "differ in

their expectations for the level of community leadership that they want the Institute to exert on the scientific capabilities of the HST and JWST missions.” This difference may have contributed to a “frayed” relationship between STScI and NASA and difficulties during negotiations over the terms of the Institute’s role in JWST. Five months after NASA Administrator Sean O’Keefe cancelled Servicing Mission 4, the committee reported that while STScI’s relationship with NASA Goddard was “fine,” relations between the Institute director’s office and NASA Headquarters were “very strained.” The servicing mission cancellation “has caused a nearly complete breakdown in communications between Headquarters and the Institute which may be difficult to repair.”⁷⁰ Concerns about the possible premature loss of HST were lowering staff morale, but the committee noted that other managerial issues were also involved. And it stated that the Institute leadership’s uncompromising approach to saving SM4 “is of great concern” to STScI staff and the visiting committee, forcing “a very confrontational situation” with NASA and causing a loss of confidence in the director’s office.⁷¹

A few weeks later in July 2004, Beckwith announced that he would serve just one more year as director and leave STScI in September 2005. When Beckwith announced his departure, the fate of SM4 and HST were still very much in play, and he linked his decision to the high profile he had gained from his efforts to save HST. “This advocacy gave me a high level of visibility that could jeopardize what I can achieve for the community in the future,” Beckwith said in a prepared statement.⁷² By the time Beckwith left the following year, NASA had a new Administrator who promised to reconsider O’Keefe’s decision to cancel the servicing mission. While Beckwith’s poor relationship with NASA Headquarters clearly caused him to leave, the critical visiting committee report also hinted that Beckwith’s departure from STScI was hastened by growing morale problems inside the Institute. One was the disquiet amongst women working at STScI about the work environment there, which will be discussed in the next chapter. Beckwith also made unpopular decisions, denying tenure to some astronomers at STScI. While he felt that he had a mandate to keep academic standards very high at STScI, he later admitted that the controversial tenure decisions “weakened” his position.⁷³

PREPARING FOR JWST

Mattias (Matt) Mountain, a physicist and astronomer trained at the Imperial College of Science and Technology of the University of London, became STScI director after having served as director of the Gemini Observatory, where he had supervised the building of the two Gemini telescopes. Mountain also

served as a member of the JWST Science Working Group since 2002, and so he arrived at the Institute knowing JWST well but not HST.⁷⁴ He recalled getting a crash course in HST while he prepared for Servicing Mission 4 from many Institute staff. Most important was Roger E. Doxsey, who had started at STScI in 1981 and became so famous there for his thorough knowledge of HST's inner workings that he was the natural choice for Hubble Mission Head. Doxsey, whose name has been linked to innovations such as snapshot observations and operating with only two gyroscopes, died at age 62 a few months after SM4 in 2009. Despite this setback, HST continued to operate well through Mountain's decade at the helm of STScI. Mountain introduced a matrix organization scheme to recognize that STScI had become a "multi-mission organization" that gives many people a role in HST, JWST, and STScI's growing multi-mission data archive, which will also be discussed in the next chapter.⁷⁵

Kenneth R. Sembach, who had a long background with STScI and HST, including work as interim deputy director, Hubble Project Scientist and Doxsey's successor as Hubble Mission Head, became STScI's fifth director in October 2015 after Mountain was named president of AURA. He had also been a Hubble Fellow at MIT and worked at Johns Hopkins University on the Far Ultraviolet Spectroscopic Explorer mission.⁷⁶ Sembach became director as JWST moved toward to a scheduled launch date in 2018 that was later postponed to 2021. The approach of the JWST launch has affected his approach to Hubble. With strong support from Sembach, NASA, and STScI announced that JWST's early data would be made available immediately to the whole astronomical community to familiarize it with the new telescope's abilities. In an interview in 2017, he said that he expected that some observations would lead astronomers to ask for Hubble observations of the same



▲ Hubble Project Manager Patrick Crouse in 2016. (Christopher Gainer)

object, and was planning for that eventuality. He also said that as HST nears the end of its mission, he was looking to dedicate more of its time to large-scale observing programs “that will have really longer-lasting value, and will be useful for multiple scientific purposes, that will really enhance the archival value of the mission as it goes on.”⁷⁷

In the years since HST was last restored in Servicing Mission 4, HST has been subject to NASA’s Senior Review process that ensures that its spacecraft continue to deliver the best science possible at the lowest cost. Hubble has undergone the Senior Review Process in 2012, 2014, 2016, and 2019. Under the review process, HST was assessed by a committee of top scientists who looked at HST’s latest scientific mission objectives and its effectiveness in meeting previous sets of objectives, its efficiency and the quality of its management. The 2019 review found that HST “continues to excel in scientific productivity and remains a key element in the achievement of NASA’s strategic goals, and is continuing to meet the aspirations of the worldwide astronomy community.” It added that “The Project has taken a proactive stance on mitigating the likely failure modes and degradation in the telescope and instrumentation.”⁷⁸ The HST Project Office has undertaken studies of HST end of life issues, but Project Manager Patrick Crouse explained that no definite decisions had been made while HST remains highly productive and in good operating condition.⁷⁹

CHANGING ASTRONOMY

The success of HST operations involved control functions centered at NASA’s Goddard Space Flight Center. Just as HST has changed over its time in space, so have its controlling institutions. Goddard’s control center for HST underwent many changes as computing and other electronic technologies became more powerful during the nearly three decades since HST began operations. Goddard also created a group of engineers dedicated to supporting HST servicing missions, a group that has moved on to prepare for future satellite servicing work. The Space Telescope Science Institute was originally founded to carry out HST science operations, and its story was intimately tied to that of HST, even as it took on responsibility for operating HST’s successor telescope, JWST. The European Space Agency also created infrastructure for HST, but its own budget issues and the revolution in networking that arose in the 1990s caused ESA to reduce its role in the HST program. In discussing HST and its infrastructure, it is also important to talk about the major impact they have had on astronomy and how it is done. It is this story to which this study now turns for its final chapter.

ENDNOTES

- 1 Smith, *The Space Telescope*, pp. 371–372. With these costs, Smith called HST “the most expensive scientific instrument ever built.” The \$2 billion price tag in 1990 would equal \$3.9 billion in 2019. The Large Hadron Collider, which began operation in 2008, cost more than \$5 billion, adjusted for inflation. Media cost estimates for HST at the time of HST’s launch varied from \$1.5 billion in *USA Today* and \$1.54 billion in the *Wall Street Journal* to \$2.1 billion in the *Washington Post* and the *New York Times*. The *New York Times* stated that the original \$1.5 billion cost for HST came before the 1986 Challenger disaster, which added \$300 million in storage and servicing costs and another \$300 million for operating and testing costs. See Paul Hoversten, “‘New Era’ for Mankind Will Open Today,” *USA Today* (25 April 1990): A1; Kathy Sawyer, “Hunting the ‘Blueprint of Eternity,’ Long-Delayed \$2.1 Billion Hubble Space Telescope Set for Launch,” *Washington Post* (April 1990): A1; John Noble Wilford, “Telescope is Set to Peer at Space and Time,” *New York Times* (9 April 1990): A1; Bob Davis, “Hubble Space Telescope, Plagued by Problems, May Open the Heavens But Has Cost the Earth,” *Wall Street Journal* (5 April 1990). For information on the Higgs Boson, see Alex Knapp, “How Much Does It Cost to Find a Higgs Boson?” *Forbes* (5 July 2012) <https://www.forbes.com/sites/alexknapp/2012/07/05/how-much-does-it-cost-to-find-a-higgs-boson/#5f0604263948> (accessed 12 August 2019).
- 2 This topic was raised at a 2005 congressional hearing when a House Committee discussed the costs of Servicing Mission 4 and a possible robotic repair mission with witnesses from the scientific community, including STScI Director Steve Beckwith. The scientists, including Beckwith warned that their support for HST would waver if the SM4 costs were shifted from the human spaceflight budget to the space science budget, which would endanger other science missions. See Warren E. Leary, “Repair Costs for Hubble Are Vexing to Scientists,” *New York Times*, (3 February 2005); Brian Berger, “Hubble Hearing Opens Debate on a Hot Topic,” *Space News* (7 February 2005): 6.
- 3 “HST History for GSFC,” Excel spreadsheet supplied to author with explanatory notes from Craig Tupper, NASA, 3 October 2017; James F. Jeletic, e-mail to author, “Cost of Hubble,” 27 October 2016.
- 4 A NASA website last updated in 2017 estimated the average cost of an individual Shuttle mission at \$450 million, which would add up to \$2.7 billion for the six HST Shuttle missions. The same number appeared in the website after a 2015 update and appears to predate that time, which would mean that the figure should be noticeably higher in 2019 dollars. NASA Kennedy Space Center, “Space Shuttle and International Space Station,” updated 3 August 2017, https://www.nasa.gov/centers/kennedy/about/information/shuttle_faq.html#10 (accessed 12 August 2019). In 2006, *Space News* quoted a cost of \$900 million for Servicing Mission 4, and in 2009 on the eve of the mission, Space.com quoted Ed Weiler as putting a price tag of \$1.1 billion on the mission. In both cases, those estimates in dollars of the time included the cost of equipment for HST and expenses for the years that the Satellite Servicing Team was kept together at GSFC. “Editorial: Five More Years,” *Space News* (8 November 2006); Andrea Thompson, “Hubble FAQ: Inside the Last Space Telescope Repair Mission,” Space.com, 1 May 2009. When the Shuttle program was about to end in 2011, a Space.com article divided an estimated cost for

the entire Shuttle program of \$209 billion in 2010 dollars by the 135 Shuttle flights to arrive at a rough cost of \$1.6 billion per flight. Mike Wall, “The Shuttle Program, Was It Worth It?” Space.com, 5 July 2011. The ESA declined to disclose how much it spent on HST.

- 5 J. Krige, A. Russo, and L. Sebesta, *A History of the European Space Agency 1958–1987, Volume II, The Story of ESA, 1973 to 1987* (Noodwijk, The Netherlands: ESA Publications Division, 2005), p. 175. See also John Krige, Angelina Long Callahan, and Ashok Maharaj, *NASA in the World: Fifty Years of International Collaboration in Space* (New York: Palgrave Macmillan, 2013).
- 6 See chapter one and “MOU between the ESA and NASA,” in *Exploring the Unknown, Vol. 5*, pp. 670–681. See also F. Macchetto, “European Astronomy and the Space Telescope: The Space Telescope European Coordinating Facility,” in Donald N. B. Hall, *The Space Telescope Observatory: Special Session of Commission 44, IAU, August 1982* (STScI, NASA Scientific and Technical Information Branch, 1982. NASA CP-2244), pp. 16–19.
- 7 Antonella Nota, Mark McCaughrean, Bob Fosbury, Colleen Sharkey, and Carl Walker, “Seeing with Hubble Vision,” *ESA Bulletin*, no. 142 (May 2010): 3–11; Duccio Macchetto, oral history interviews by author, 9 May 2017; Antonella Nota, 17 May 2017; Helmut Jenkner, 19 May 2015; Christopher Burrows, 15 February 2017; Rudolf Albrecht, 9 November 2015. Although the 15 ESA employees at STScI represented about 15 percent of its early staff, the number did not increase as STScI’s staff grew.
- 8 “Space Telescope European Coordinating Facility,” *ESA Bulletin*, no. 142 (May 2010): 4–5; Albrecht OHI, pp. 12–21.
- 9 Macchetto OHI, pp. 12–13; Committee on International Space Programs, National Research Council, and European Space Science Committee, *U.S.-European Collaboration in Space Science* (Washington, DC: National Academy Press, 1998), p. 47; Daniel Fischer and Hilmar Duerbeck, *Hubble Revisited: New Images from the Discovery Machine* (New York: Springer-Verlag, 1998), p. 196.
- 10 Duccio Macchetto, e-mail to author, 14 August 2019. Macchetto said the SM4 cancellation decision upset the ESA Director General Jean-Jacques Dordain. Macchetto added that after the cancellation “There were both open and confidential contacts with the US political and scientific communities and a reminder that ESA was a partner not just a contractor.” The newsletter of the European Coordinating Facility for HST was silent about ESA input in the cancellation and reinstatement decisions except for the following statement at the time of the cancellation decision: “There is little we Europeans can do directly to change NASA’s decision which, apparently, is final.” Eric Ensellem and Monica Tosi, “Cancellation of Hubble Servicing Missions: An Open Letter from the Two European Members of the Space Telescope Users Committee,” *ST-ECF Newsletter* (January 2004): p. 3.
- 11 Albrecht OHI, 20; Robert Fosbury, “Closure of the ST-ECF,” *ST-ECF Newsletter*, No. 48 (December 2010): p. 2; European Space Agency, “European Hubble Archive Moves to Spain,” 22 June 2012, http://www.esa.int/Our_Activities/Space_Science/European_Hubble_archive_moves_to_Spain (accessed 30 July 2017); European Space Agency, “A new Hubble Archive Mirror in Europe,” 17 December 2018, <https://spacetelescope.org/forscientists/announcements/sci18006/> (accessed 22 April 2019).

- 12 Committee on International Space Programs, *U.S.-European Collaboration in Space Science*, p. 47.
- 13 See Lane E. Wallace, *Dreams, Hopes, Realities: NASA's Goddard Space Flight Center, The First Forty Years* (Washington, DC: NASA History Office, SP-4312, 1999).
- 14 James Jeletic, oral history interview by author, 19 May 2017, p. 18; Patrick Crouse, oral history interview by author, 17 June 2016, pp. 5–6. Lockheed merged with Martin Marietta on 15 March 1995, to form Lockheed Martin. See also Lockheed Martin News Release, “Space Foundation Honors Hubble Servicing Mission Team That Extended Life Of The Orbiting Observatory,” 13 April 2010, <http://www.lockheedmartin.com/us/news/press-releases/2010/april/SpaceFoundationHonorsHubb.html> (accessed 26 July 2017).
- 15 Ken Carpenter, oral history interview by author, 30 April 2015, pp. 7–10; Jennifer Wiseman, oral history interview by author, 8 May 2015, pp. 1–3. In 2015, there were four HST Project Scientists on staff at Goddard. AURA also operates the Gemini telescopes, the National Optical Astronomy Observatory and National Solar Observatory.
- 16 Smith, *The Space Telescope*, pp. 354–361.
- 17 “About SSPD,” <https://sspd.gsfc.nasa.gov/about.html> (accessed 15 July 2017).
- 18 NASA Facts, *Three Newly Designed Tracking and Data Relay Satellites To Help Replenish Existing On-orbit Fleet* (NASA Goddard Space Flight Center, FS 2001-9-025-GSFC, September 2001). For more on NASA's tracking networks, see Sunny Tsiao, “Read You Loud and Clear!” *The Story of NASA's Spaceflight Tracking and Data Network* (Washington, DC: NASA, SP-2007-4232, 2008).
- 19 Ford Aerospace, “Phase I Final Report Preliminary Operations Requirements and Test Support (PORTS) Payload Operations Control Center (POCC) for the Space Telescope,” Ford Aerospace, FACC-TR38009, November 1981; Larry Dunham, “HST ground system” e-mail to author, 21 September 2017; “Goddard dedicates Space Telescope Control Center,” *Goddard News*, 1, no. 2 (15 February 1984): 1; Albert Sehlstedt, Jr., “Control center for space telescope is dedicated,” *Baltimore Sun* (15 February 1984); Smith, *The Space Telescope*, pp. 357–362.
- 20 Smith, *The Space Telescope*, pp. 337–340, 348–353.
- 21 Riccardo Giacconi, *Secrets of the Hoary Deep* (Baltimore, MD: Johns Hopkins University Press, 2008), p. 227.
- 22 Giacconi, *Secrets of the Hoary Deep*, p. 228; Smith, *The Space Telescope*, p. 338; Ray Villard, “The World's Biggest Star Catalogue,” *Sky & Telescope* (December 1989): 583–589.
- 23 Villard, “Biggest Star Catalogue”; Helmut Jenkner, oral history interview, 19 May 2015. The development of the catalog has also been extensively canvassed in STScI Annual Reports.
- 24 Villard, “Biggest Star Catalogue.”
- 25 Barry Lasker, “Digitized Optical Sky Surveys at STScI,” *STScI Newsletter* 11, no. 2 (December 1994): 39; STScI, “The Original National Geographic Society—Palomar Observatory Sky Survey Now Available on 8 CD ROMs,” news release STScI-1996-20, 30 April 1996.
- 26 Villard, “Biggest Star Catalogue”; STScI “Bigger, Better Catalog Unveils Half a Billion Celestial Objects,” news release STScI-2001-18, 4 June 2001; Barry M. Lasker et al., “The

- Second-Generation Guide Star Catalog: Description and Properties,” *The Astronomical Journal* 136 (August 2008): 735–766; STScI, “NASA Recognizes HST Star Catalog Developers,” news release STScI-1993-07, 2 April 1993. The original National Geographic–Palomar Sky Survey in the 1950s served a similar purpose for the 200” Palomar telescope as the HST Guide Star sky surveys have done. See Florence, *The Perfect Machine*, p. 397.
- 27 Riccardo Giacconi, *Annual Report to AURA Board of Directors: Space Telescope Science Institute* (STScI, Baltimore, MD, March 1987), p. 1.
 - 28 Smith, *The Space Telescope*, pp. 348–352; Riccardo Giacconi, *Annual Report to AURA Board of Directors: Space Telescope Science Institute* (STScI, Baltimore, MD, April 1986), pp. 7, 27–31, 38; Giacconi, *STScI Annual Report*, 1987, p. 4; Giacconi, *Secrets of the Hoary Deep*, pp. 229–232; Edward Ruitberg, oral history interviews by author, 16 May 2017, pp. 4–5; and Robert Brown, 14 December 2016, p. 2. Archiving and calibration functions of the ground system are discussed in chapter nine.
 - 29 Smith, *The Space Telescope*, pp. 369–370; Michael Braukus, “NASA Calls HST Ground Test a Success,” *Goddard News* 34, no. 7, July 1988; “Primary Objectives for ST SCI April 1, 1988 Through September 30, 1988,” Appendix to Audit Report, NASA Office of Inspector General, “Space Telescope Science Institute, Goddard Space Flight Center, 19 June 1989,” A17–A21.
 - 30 Ed Ruitberg OHI, part 1, pp. 10–11; Larry Dunham, comments on chapter draft, 7 September 2017; Riccardo Giacconi, *Annual Report to AURA Board of Directors: Space Telescope Science Institute* (STScI, Baltimore, MD, March 1989), pp. 32–33.
 - 31 NASA Office of Inspector General, “Space Telescope Science Institute, Goddard Space Flight Center, 19 Jun 1989,” pp. 1–3, 7–13; Giacconi, *STScI 1990 Annual Report*, 2.
 - 32 Space Science Board, The National Research Council, *Institutional Arrangements for the Space Telescope: Report of a Study at Woods Hole, Massachusetts, July 19–30, 1976* (Washington, DC: National Academy of Sciences, 1976), pp. 8–15, 27–28; Giacconi, *STScI 1991 Annual Report*, pp. 38–39.
 - 33 Space Telescope Science Institute, *MA-03 Technical Management Plan Final Version, June 1995* (Baltimore, MD: STScI), pp. 31–34.
 - 34 Tatarewicz, “HST Servicing Mission,” p. 377; Dunham OHI, pp. 8–9; Chaisson, *The Hubble Wars*, p. 328.
 - 35 NASA Fact Sheet, “The Hubble Space Telescope Second Servicing Mission (SM-2): Hubble Space Telescope Operations Control Center,” February 1997, NASA Goddard Space Flight Center, FS-97(01)-001-GSFC; Lockheed Missiles and Space Company, Inc., “Hubble Space Telescope: Media Reference Guide,” 1990, 4-1–4-16; Larry Dunham, “STOCC questions updated,” e-mail to author, 3 November 2017. See also James E. Reis, oral history interview by John Ruley, 11 December 2017.
 - 36 NASA Facts Sheet, “Hubble Space Telescope–High Fidelity Simulator,” NASA Goddard Space Flight Center, 2015, FS-2015-9-339-GSFC. VEST is also discussed in chapter three.
 - 37 NASA Goddard slide presentation, “Goddard Space Flight Center Hubble Space Telescope Facility Tour,” 2015, pp. 4–6; Richard Burley, et al., “Automation of Hubble Space

- Telescope Mission Operations,” American Institute of Aeronautics and Astronautics, 2012, p. 3.
- 38 Larry Dunham, comments on chapter draft, 7 September 2017; Chaisson, *The Hubble Wars*, pp. 73–75, 160–163; Dunham OHI, pp. 8–9; Rothenberg OHI, p. 13; Crabb OHI, pp. 4–6.
- 39 Larry Dunham, e-mail to author, 21 September 2017; Larry Dunham, comments on chapter draft, 7 September 2017; Dunham OHI, pp. 11, 17.
- 40 Giacconi, *1991 STScI Annual Report*, 2-3; Giacconi, *1992 STScI Annual Report*, 10-1.
- 41 STScI, *MA-03 Technical Management Plan Final Version, June 1995*, pp. 7–8.
- 42 Giacconi, *Secrets of the Hoary Deep*, p. 275.
- 43 Leckrone, OHI, 6 May 2015, p. 18.
- 44 Robert Williams, oral history interview by author, 21 May 2015, part 1, 6; H. S. Stockman, *Annual Report to AURA Board of Directors: Space Telescope Science Institute*, (STScI, Baltimore, MD, March 1993), pp. 1–3.
- 45 *1993 Space Telescope Science Institute Visiting Committee Report*, pp. 4–6; Williams, *1994 STScI Annual Report*, pp. 1–3. Robert Williams, *Annual Report to AURA Board of Directors: Space Telescope Science Institute* (STScI, Baltimore, MD, March 1995), p. 2; Robert Williams, *Annual Report to AURA Board of Directors: Space Telescope Science Institute* (STScI, Baltimore, MD, March 1996), pp. 1–2. See also Williams OHI, part 1, 2. Staff grew to 450 in 1993 and fell to 350 in 1994, according to STScI’s 1997 Annual Report (4).
- 46 Smith, *The Space Telescope*, discusses HST’s 1970s and 1980s budget problems in detail. The budgetary and political environment surrounding NASA during the administrations of George H. W. Bush, Bill Clinton, and George W. Bush is discussed in Glen R. Asner and Stephen J. Garber, *Origins of 21st-Century Space Travel: A History of NASA’s Decadal Planning Team and the Vision for Space Exploration, 1999–2004* (Washington, DC: NASA, SP-2019-4415, 2019).
- 47 The national debt tripled during the Reagan years to \$3 trillion, and another \$1 trillion was added during the George H. W. Bush administration, while annual deficits ranged between \$128 billion and nearly \$300 billion, mainly due to tax cuts, increased military spending and maintenance of social programs. Michael Schaller, *Right Turn: American Life in the Reagan-Bush Era 1980–1992* (New York: Oxford University Press, 2007), pp. 116–117. Dealing with the federal deficit was a major theme of much of Bill Clinton’s presidency. See Bob Woodward, *The Agenda: Inside the Clinton White House* (New York: Simon & Schuster, 1994) and Bill Clinton, *My Life* (New York: Alfred A. Knopf, 2004), pp. 621–622, 745, 870–871. Deficit fighting was a key part of Clinton’s economic plan and budget programs as president. In the 1994 congressional elections, Republicans took control of Congress with the help of their Contract with America, which contained more aggressive efforts to combat the deficit. One promise, to introduce a constitutional amendment mandating balanced budgets, fell just short of passing Congress. The federal budget was balanced by 1999, but fell out of balance later due to further tax cuts, economic problems, and military actions that followed the terrorist attacks of 11 September 2001. Since NASA accounted for only one percent or less of federal spending during this time, its budget did not figure in the larger budget debates, except amongst those concerned with space spending.

- 48 *1995 Space Telescope Science Institute Visiting Committee Report*, 1995, Baltimore MD, 3; Burch OHI, 7 June 2017, pp. 1–2. See Daniel S. Goldin, “NASA in the Next Millennium,” speech at the 187th American Astronomical Society Meeting in San Antonio, TX, 17 January 1996. For figures on NASA spending, see the *Guardian* datablog, “NASA Budgets: US Spending on Space Travel Since 1958 UPDATED,” the *Guardian*, undated, <https://www.theguardian.com/news/datablog/2010/feb/01/nasa-budgets-us-spending-space-travel> (accessed 30 July 2016). NASA spending in FY 1994 fell to \$13.695 billion from \$14.305 billion the year before, a figure that was also lower than the 1991 and 1992 budgets. The 1995 budget was even lower at \$13.378 billion. All numbers unadjusted for inflation.
- 49 Michelle Mittelstadt, “Congress Officially Kills Collider Project,” *Sun Journal* (Lewiston, MN, 22 October 1993): 7; Piers Bizony, *Island in the Sky: Building the International Space Station* (London: Aurum Press, 1996), pp. 70–71. A similar but more recent concern about Congress and science is raised in Steven Weinberg, “The Crisis of Big Science,” *The New York Review of Books* (10 May 2012).
- 50 John C. Campbell, oral history interview by author, 22 May 2017, p. 9. Campbell credited Ed Weiler with protecting HST’s budget at NASA Headquarters.
- 51 Williams, *1996 STScI Annual Report*, pp. 16–20; *1995 IVC Report*, pp. 4–6; Williams, *1995 STScI Annual Report*, pp. 20–24; “Operations and Ground Systems, Code 441,” *Hubble Space Telescope Newsletter*, GSFC 5, no. 5 (May 1995): 2–3; Dunham, comments on chapter draft; Larry Dunham, “HST ground system,” e-mail to author, 20 September 2017; NASA Goddard slide presentation, “Goddard Space Flight Center Hubble Space Telescope Facility Tour,” 2015, 25–32; Crabb OHI, pp. 11–12.
- 52 Williams, *1994 STScI Annual Report*, p. 3; Williams, *1996 STScI Annual Report*, pp. 17–18; Space Telescope Science Institute, *Annual Report 1998* (1999) p. 6; Neill Reid, oral history interview by author, 2 November 2016, p. 3; “HST Primer for Cycle 25: 2.2 Orbital Constraints,” STScI, http://documents.stsci.edu/hst/proposing/documents/pri_cy25/Ch_2_Systemoverview3.html (accessed 23 July 2017).
- 53 See Campbell OHI and Preston Burch, oral history interview by author, 9 November 2015.
- 54 Preston Burch, oral history interview by author, 7 June 2017; Tsiao, *Read You Loud and Clear!* pp. 321–326; Space Telescope Science Institute, *Annual Report 2000* (Baltimore, MD: STScI, 2001), p. 20; GSFC Hubble Project PowerPoint, *Operational Readiness Review: FOT STScI to GSFC Relocation*, 9 February 2006; James Reis OHI, pp. 6–11.
- 55 Burley et al., “Automation of HST Operations,” pp. 2–3.
- 56 Dunham OHI, p. 21; Burley et al., “Automation of HST Operations,” pp. 1–2; James Reis OHI, pp. 11–14.
- 57 Status Report from NASA Headquarters, “Message from the NASA Administrator: March 24 Update on Agency Response to Coronavirus,” 24 March 2020.
- 58 NASA Facts Sheet, “Hubble Space Telescope—Mission Operations,” 2015, NASA Goddard Space Flight Center, FS-2015-3-267-GSFC; NASA, “Hubble: An Overview of the Space Telescope,” 2013, NASA Goddard Space Flight Center, NP-2013-07-032-GSFC, pp. 39–44; NASA Goddard slide presentation, “Goddard Space Flight Center Hubble Space Telescope Facility Tour,” 2015, p. 5; Patrick Crouse, oral history interview with author, 17 June 2016. HST was organized with a HST Program Office (Code 440) and two projects:

- (1) HST Operations Project (Code 441), and (2) HST Flight Development and Servicing Project (Code 442). The HST Program Office, Code 440, was reorganized into the Astrophysics Projects Division. Code 440, containing multiple projects, including Code 441, the HST Operations Project.
- 59 STScI *Plan for Implementation of Two Gyro Mode*, STScI, 13 November 2004, STScI Archive, Box file “HST Operations Papers, various 1995–2005,” JHU Library Special Collections; NASA Goddard slide presentation, “Goddard Space Flight Center Hubble Space Telescope Facility Tour,” 2015, pp. 19–22.
 - 60 Smith, “HST in Orbit: Ten Years and Counting,” p. 34. This issue is discussed extensively in chapter four.
 - 61 NASA Office of Aerospace Technology, Commercial Technology Division, “Astronomy Software,” *Spinoff 2002* (Washington, DC: NASA, 2002) 81; Villard, “Biggest Star Catalog.”
 - 62 NASA Headquarters, *Spinoff 1994*, NP-214, pp. 46–47; NASA Headquarters, “Health and Medicine Spinoffs,” NP-2009-06-488-HQ, 2009. While this work to apply advances in CCD technology to medical imaging succeeded, an earlier effort in the 1990s to apply image deconvolution techniques developed for HST to analyze mammograms did not succeed. Lauer OHI, pp. 17–18.
 - 63 NASA Goddard, “Hubble Technology Benefits New Satellite Phone System,” news release 99-3, 14 January 1999.
 - 64 NASA Innovative Partnerships Program, “Star Tracking Tools Enable Tracking of Endangered Animals,” *Spinoff 2009* (Washington, DC: NASA, 20029) pp. 90–91.
 - 65 NASA, “Hubble systems Optimize Busy Hospital Schedules,” *Spinoff 2009*, 44.
 - 66 NASA, *Technology Opportunity: A Computer-Controlled Power Tool*, NASA Office of Technology Transfer, NASA Goddard, 2006; Jarrett Cohen, NASA High End Computing Program, “Simulations Enable Successful Hubble Navigation Experiment,” 28 July 2009; NASA Goddard, “NASA’s Goddard Space Flight Center Licenses Advanced Hybrid Processor Technology to Genesis Engineering Solutions Inc.,” news release 17-11, 4 April 2017. See also NASA Goddard Space Flight Center, *Hubble Technology Transfer*, NP-2018-1-157-GSFC, 2018.
 - 67 Robert E. Williams, *Annual Report to AURA Board of Directors: Space Telescope Science Institute*, (STScI, Baltimore, MD, March 1997), pp. 1–2; Robert E. Williams, *Annual Report to AURA Board of Directors: Space Telescope Science Institute*, (STScI, Baltimore, MD, March 1998), pp. 1–2.
 - 68 *Report of the Institute Visiting Committee for the Space Telescope Science Institute*, (Baltimore, MD, May 1999), pp. 5–6; STScI, *STScI 1998 Annual Report*, pp. 9, 16.
 - 69 STScI, “Space Telescope Science Institute Gets New Director,” *Report of the 1998 Interim Institute Visiting Committee*, news release STScI-PR98-09, 27 January 1998; Report of the 1998 Interim Institute Visiting Committee, (STScI, Baltimore, MD, April 1998); *IVC Report*, 1999, p. 6; STScI, *STScI 1998 Annual Report*, p. 5; STScI, *STScI 1999 Annual Report*, pp. 16, 22–30. The archive will be discussed in chapter nine.
 - 70 *Report of the Institute Visiting Committee for the Space Telescope Science Institute*, June 2004, Baltimore MD, pp. 2–3.

- 71 Ibid, pp. 2–4. The report also includes a response from STScI management.
- 72 Association of Universities for Research in Astronomy, Inc., News Release, “Steven Beckwith to Conclude Appointment as Director of Space Telescope Institute,” 16 July 2004, <http://www.aura-astronomy.org/news/archive/newsArchiveResult.asp?nuid=78> (accessed 18 July 2016). See also “Hubble Advocate Quits Institute,” *Baltimore Sun*, 17 July 2004.
- 73 Beckwith OHI, 26 September 2016, p. 19.
- 74 STScI, “New Director Appointed at Space Telescope,” news release STScI 2005-08, 13 June 2005.
- 75 Matt Mountain, oral history interview by author, 4 November 2016, pp. 17, 21–22; Dennis Overbye, “Rodger Doxsey, Astronomer Who Worked on the Hubble, Dies at 62,” *New York Times* (18 October 2009).
- 76 STScI, “AURA Appoints New STScI Director,” news release STScI-2015-41, 30 October 2015.
- 77 Kenneth R. Sembach, oral history interview by author, 25 May 2017, p. 10; NASA news release, “NASA’s James Webb Space Telescope Early Science Observations Revealed,” 13 November 2017.
- 78 NASA, *2019 Astrophysics Senior Review–Hubble Report* (Washington, DC: 8–10 May 2019).
- 79 Crouse OHI, pp. 15–20.



CHAPTER NINE

Astronomy: A Science Transformed

▲ This infrared view of the Horsehead Nebula, otherwise known as Barnard 33, was released in 2013. (NASA/ESA/Hubble Heritage Team [AURA/STScI]; heic1307a)

Astronomy and the way it was done changed in many ways during the Hubble Space Telescope's operational lifetime, and HST played no small part in facilitating those changes. Where once astronomy was a solitary pursuit, it has become a team activity. Today more astronomical research than ever takes place at data archives. For those who want to make observations with Hubble, the Space Telescope Science Institute has set up a complicated process to ensure that the highest quality observing programs are chosen. Along the way, NASA and the Institute have worked to open HST in particular and astronomy in general to more women and to more groups who have not traditionally been involved in astronomy at the top level. This chapter will examine the changes to astronomy that were already in motion when HST began its work in space in April 1990, the changes that followed, and Hubble's role in facilitating those changes. These changes encompass how astronomy is done and who does it.

Even before it was launched, Robert W. Smith wrote extensively about HST as an example of Big Science. Hubble brought together multiple institutions of many kinds, along with several groups and numerous individuals, in all cases many more than had ever come together for any individual astronomy program. Similarly, HST required a quantum leap in money and political support to become reality.¹ Once it began operations, HST moved to the center of NASA's astronomy programs at a time when NASA became the largest funder of astronomy in the United States, and so HST became the most influential telescope of its time.

At the same time that HST began operating, astronomical observatories on the ground were also becoming more complex, with larger and more expensive instruments that required large teams of experts to operate and process the data they produce. Historian W. Patrick McCray later noted the propensity of many astronomers to compare their large telescopes to another prime example of Big Science, particle accelerators.² Larger teams from multiple institutions became necessary to draw scientific meaning from the data, as was the case for the teams discussed in chapter six that found that the universe is expanding at an accelerating rate. The digitization of data has made it much easier for large teams of astronomers operating at far-flung locations to share data and work together. Astronomy was already a growing field attracting larger numbers of people than ever before.

Another big change in astronomy involved the nature of data, which was moving to digital form. Although this shift was already well underway when Hubble was launched, HST's high profile role in astronomy meant that it accelerated some of the changes that digital data brought to astronomy. The ease of moving data also made it possible to create large depositories of data, and HST catalyzed the creation of major new astronomical archives. Because HST and the Institute first created to run its science operations produced an influential archive that habituated many astronomers to using archived data, Hubble's influence will long outlast the lifetime of the observatory itself.

NEW KINDS OF OBSERVATORIES

HST began operations in the last decade of a century that had already seen major transformations in astronomy. Early in the 20th century, visionaries like George Ellery Hale were backed by philanthropists such as Andrew Carnegie who made possible the construction of large telescopes around the United States, notably the Mount Wilson and Palomar observatories in California. Access to those telescopes was restricted to small observing staffs including people like Edwin Hubble, working under powerful and influential observatory directors. The role of weapons-related science during the Second World War and the Cold War that followed drove massively increased government funding for scientific research. In turn, this produced increasing interest and opportunities in the sciences, which led universities to create and expand astronomy programs, and in turn produced growing demand for observing time. The post-war years also saw astronomers make use of rocket-borne instruments, radio telescopes, and other new technologies.³

Observatories and their sponsoring institutions began to cooperate after World War II to build facilities that could compete with existing observatories

and take advantage of newly available government funding for science. The Association of Universities in Research for Astronomy was created in 1957 with seven founding universities and encouragement from the National Science Foundation (NSF), a federal funding agency created in 1950. By the late 1950s, AURA was building the National Optical Astronomy Observatory on Kitt Peak in Arizona with government support from NSF, and its expansion continued in the years that followed with observatories elsewhere in the United States and in Chile. AURA was not unique—another consortium, Associated Universities, Inc., created the National Radio Astronomy Observatory with NSF support in 1956. NASA's entrance into astronomy and space science soon after its creation in 1958 opened another source of federal support for astronomy.⁴

The creation of new observatories starting in the 1950s, managed by multiple universities with government funding, meant that astronomical observing opportunities expanded vastly beyond the traditional small and facility-specific observing staffs that were the norm in the first half of the century. Although the old practices of giving staff astronomers pride of place continued at observatories like Palomar, astronomers could obtain observing time at places like Kitt Peak by simply applying for it. Technological advances simplified observing work and allowed astronomers to move from observing cages inside telescopes to more comfortable control rooms nearby. Kitt Peak astronomers made the first remote telescope observation in 1968.⁵ As discussed in chapter four, observatories began to move from photography on glass plates and photographic film to digital formats in the 1970s and 1980s, which made it much easier to store and share images and other data when computing and networking technologies advanced in the 1990s.

With information moving to digital form, many astronomers saw the need for a common format with which to share data, and this movement was particularly strong at observatories in the United States supported by the NSF. Astronomers working at Kitt Peak, the National Radio Astronomy Observatory, and those involved with HST and the Very Large Array, then both under development, worked to develop a common format to share astronomical data. In 1979, they created the Flexible Image Transport System (FITS), which not only is used for images but also for other data such as spectra, tables, and data cubes. FITS proved itself with otherwise incompatible computer systems and, more importantly, with astronomers in various fields and locations. The International Astronomical Union adopted FITS in 1982, and today it remains a standard format for sharing astronomical data. The creation of this format greatly benefitted the work of the Hubble Space Telescope and helped transform astronomy by fostering collaboration amongst astronomers in different locations. “After 1965

the telescope gradually merged with the computer, the software program, and the database into a hybrid instrument,” McCray wrote. “But computer chips and digital data alone did not remake astronomy; astronomers pursued these new tools to fulfill their desires for increased research ability and the ability to share data more easily.” In September 1989, the last photographic plate was exposed on the 200-inch Hale Telescope at Mount Palomar. After years of trials, the best-known telescope on Earth was converted from photographic plates to CCDs.⁶

Another reason astronomers wanted better ways to share data was simply because there were more astronomers than ever. At the dawn of the century, a few hundred scientists worked as astronomers worldwide. Their numbers grew rapidly after World War II to an estimated 15,000 by the year 2000. In the United States, the membership of the American Astronomical Society stood at 2,619 in 1970. By 1990, the year HST was launched, AAS membership had doubled to 5,297.⁷ This growth was fueled by the growth in observing opportunities at the new observatories and more universities offering undergraduate and graduate degrees in physics and astronomy, much of this underwritten by increased government funding.⁸ These technical, organizational, and demographic changes came to play a major role in the design of HST operations, and HST would make its own impact on how astronomy was done.

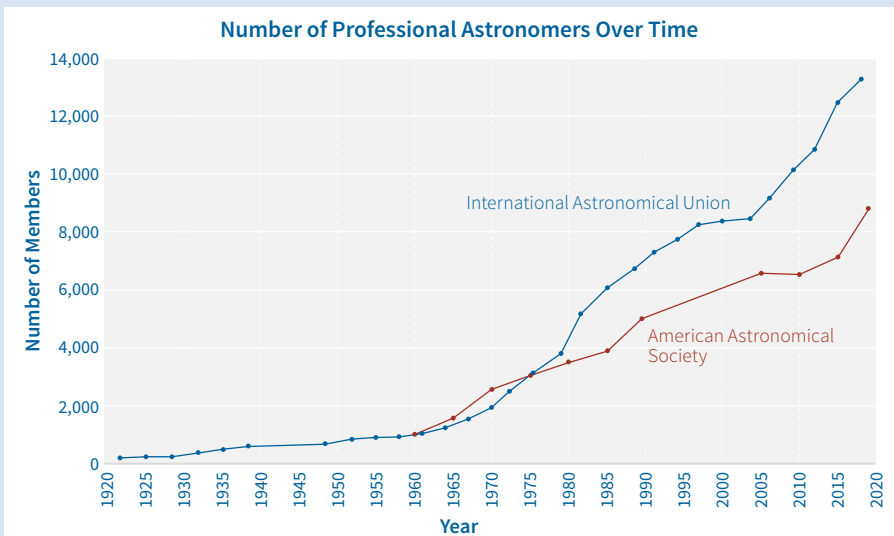

▲ Graph of total number of professional astronomers. (Data from International Astronomical Union and American Astronomical Society)

Before considering HST's place in astronomy, it is important to note that astronomers got their first exposure to the potential of space-based astronomy long before Hubble through spacecraft such as the Orbiting Astronomical Observatories (OAO), the Einstein X-ray Observatory, and the International Ultraviolet Explorer (IUE). OAO-3, also known as Copernicus, which operated from 1972 to 1981, carried

an ultraviolet telescope that was accessible to guest observers in addition to the team that created the instrument. When Einstein was launched in 1978, scientists who had not been involved in developing the program were encouraged to propose observations using the spacecraft.⁹ IUE was a cooperative program involving NASA, ESA, and the UK Science and Engineering Research Council that proved to be an important forerunner to HST.

The IUE spacecraft was launched on 26 January 1978 and was still operating when HST joined it in space. Because it was located in a geosynchronous orbit, IUE could operate around the clock without interruption, avoiding the complications of low-Earth orbits used by OAO and later by HST. IUE was much more user-friendly than the OAO spacecraft and was more available to ultraviolet astronomers. Any astronomer, regardless of where they came from, could use IUE if they made a proposal that passed a peer review process. Observers at the IUE control centers could follow their observations in real time and change them on the spot if they wanted. Albert Boggess, who became Project Scientist for HST at Goddard after directing IUE's scientific work, said IUE "had [an] important influence in convincing many astronomers that doing work with satellites was rewarding."¹⁰ IUE was especially relevant to HST because a major part of Hubble's work was in the ultraviolet, and as Boggess' statement suggested, many astronomers prepared for HST and remained busy during HST's delays in the 1980s by making observations on IUE.

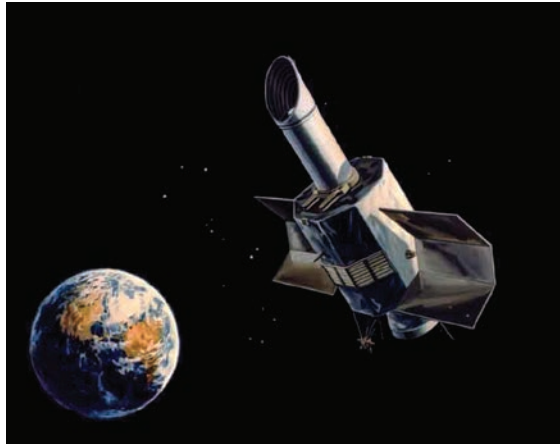

▲ Launched in 1978, the International Ultraviolet Explorer was designed to analyze ultraviolet spectra. It was a joint project between ESA, the UK Science Research Council, and NASA. (Laura Danly/C. Elise Albert/Kip D. Kuntz/NASA/ESA/STScI/U.S. Naval Academy)

HST OBSERVING TIME

As NASA and STScI prepared in the 1980s for HST operations, time allocation based on peer review was already established practice on the ground in national observatories and in space with the first space telescopes. As the first major astronomical telescope to be placed in space, HST presented new challenges for those who had to decide who would get to use it. HST's institutional infrastructure and its time allocation processes would help drive further changes in how astronomy was done.

The Hornig Report of 1976 that is considered the blueprint for STScI recommended establishing an institute that would operate in a similar fashion to national observatories like Kitt Peak that were already dedicated to use by guest investigators. Following this reasoning, the Hornig Report said the institute should facilitate “vigorous and scientifically productive participation” by visiting observers. “The Institute should solicit observing proposals from the scientific community, provide technical information and advice to potential users, and evaluate the scientific merits and engineering feasibility of the proposals, the former by an appropriate version of disinterested peer review. The Institute should establish a roster of accepted and priority-rated proposals that will be scheduled for telescope time, with due regard to seasonal, orbital, and other operational factors.”¹¹ In the original 1977 Announcement of Opportunity for the Space Telescope's instruments, NASA stipulated that about 30 percent of observation time during the first 30 months of flight would be allocated to about 90 Guaranteed Time Observers (GTOs), astronomers on the six instrument teams and scientists who had already spent considerable time designing the Space Telescope and preparing it for operations.¹²

The Hornig Report also specifically called for the Institute to maintain a library of “all preprocessed data and all output of standard production processing” from the Space Telescope for access by the scientific community, and also support processing, analysis, and publication of that data using the latest computing technology. This proposal came as observatories such as Kitt Peak and the National Radio Astronomy Observatory were moving to digital data, which made it easier to share and store data.¹³

When STScI opened in 1981, NASA's Office of Space Science and Applications established policy guidelines for the new Institute that reflected the Hornig Report recommendations, including policies covering the use of the Space Telescope and the archiving of its data at STScI and elsewhere. NASA stipulated that outside observers from anywhere, known as General Observers (GOs), would be eligible to make observations once their proposals were selected under a peer review process. They and Archival Researchers making

use of HST archived data could request funding support from NASA for the “acquisition, calibration, analysis, and publication” of HST data. Another NASA policy stipulated that HST data obtained as part of a peer-reviewed proposal was subject to a one-year “proprietary” period, after which it would be made available to the scientific community and the public.¹⁴ The policies providing NASA funding for observers and setting proprietary periods for data weren’t new. Astronomers working in ground observatories requiring peer review for observing time and producing digital data had already been granted a one-year proprietary period for data, after which that data were made available to anyone who wanted it. In the IUE program, NASA was already funding United States observers for travel, publication, and data analysis costs, and principal investigators had exclusive rights to IUE data for six months, after which the data became available to all astronomers.¹⁵ Ed Weiler, the HST Program Scientist at NASA Headquarters, worked with Neta Bahcall from STScI and others in the mid-1980s on a report that called for money to be set aside for GOs. Weiler believed strongly that the funding for IUE observers was inadequate, and so he worked to develop a realistic estimate of the money required for United States observers to process and analyze HST images and other data. He then persuaded Charles Pellerin, NASA’s director of astrophysics, to put the money in the long-term HST budget.¹⁶

Another big question in the years leading to HST’s launch concerned the amount of demand there would be for observing time on Hubble. To fulfill its responsibility to work with astronomers to get the most and the best science possible from HST, the Institute established a General Observer Support Branch in 1984. The branch’s head, Neta Bahcall, consulted with various ground-based observatories about how they decided who got observing time. But the question of how much demand there would be for HST time remained unanswered, so Bahcall and her branch members decided to conduct a survey of the worldwide astronomical community in 1984 and 1985 that received 3,030 replies out of 7,500 questionnaires sent to members of the AAS and the International Astronomical Union. Of those who responded, 2,300 respondents planned to submit HST observing proposals to STScI, which suggested that the available telescope time would be oversubscribed by a factor of 15, compared to three to one for available observing time at Kitt Peak and the European Southern Observatory, or 2.5 to one for IUE. More than four-fifths intended to analyze their data at STScI, and 55 percent said they intended to use the Institute’s data archive, with most of the rest expressing interest in the archive. While the grants attached to HST observations must have generated interest amongst the United States observers who were eligible for them, the survey demonstrated

that non-American observers who were not eligible for the grants were also highly interested in receiving HST observing time.¹⁷

The Institute, acting on the findings of the survey and recommendations from the Space Telescope Advisory Committee, set guidelines in 1985 aimed at “optimizing the scientific program on HST” to deal with the promised high demand for HST time. The guidelines included the granting of equal amounts of HST observing time to projects in each of three size categories, from small (one to 10 hours), medium (10 to 50 hours), and large projects, the latter defined as involving more than 100 hours of observing time. The following larger projects included what the STAC designated as Key Projects that were identified by the astronomical community and are discussed in chapter six: determining the distance scale of the universe, studying spectra of quasars, and obtaining lengthy exposures of empty parts of the universe.¹⁸ Neta Bahcall said there was concern that larger questions would get lost if peer review committees tried to satisfy the largest number of astronomers by giving a large number of them small amounts of time. To encourage larger proposals with larger teams, Bahcall and other Institute officials publicized their expectation that HST would be massively oversubscribed. While she didn’t want to force different groups to work together, Bahcall did want people to think seriously about working in teams. “You know there may be two, three competing proposals, but I didn’t want to get 20 competing proposals on the same topic. And the community bought into that remarkably well.” The decision to split available time between small, medium, and large proposals has been widely adopted by other observatories in space and on the ground.¹⁹

TIME ALLOCATION PROCESS

STScI created a peer review system for the observing proposals, which was more complicated than the simple peer review committees at Kitt Peak and other observatories. The STScI time allocation process included six panels, each typically made up of nine to 11 expert members from a number of astronomical disciplines to review and rank proposals within each discipline. At the beginning of HST operations, these disciplines included quasars and active galactic nuclei, galaxies and clusters, interstellar medium, stellar populations, stellar astrophysics, and solar system astronomy, but they changed over time. The rankings from these panels then went to the Time Allocation Committee (TAC) for decisions on which proposals most deserved observing time on HST. The TAC was made up of the TAC chair, the panel chairs and two or three members-at-large. The STScI director made the final allocations based on the TAC recommendations. The time allocation process is often called that TAC process.²⁰

In a typical year, 3,500 orbits were available for observations, although the observing time available at first was about half of that figure.²¹ Time on HST was allocated by observing “cycles” that were each supposed to last a year, although there were situations where the length of a cycle could be lengthened or shortened to accommodate the timing of a servicing mission that would affect the availability of instruments on board HST. Therefore, the TAC committee and its associated panels would meet annually in advance of the start of the cycle whose time was being allocated, but meeting dates could change if the length of the current cycle changed. Because of occasional slips in starting dates for observing cycles, HST Cycle 27 began in 2019 during the 30th year of HST operations. Observing proposals for Cycle 27 were due in April 2019 and the TAC meetings took place the following June.

In October 1985, when HST’s launch was thought to be less than a year away, STScI sent out its first solicitation for General Observer proposals in Cycle 1. When NASA postponed the launch after the Challenger disaster, the due date for proposals was also pushed back, first to October 1986 and again as NASA delayed HST’s launch date.

By the time the final deadline for Cycle 1 observing proposals was reached two years later, 1,500 astronomers from 30 countries and more than 400 institutions had submitted nearly 600 proposals. After initial processing by Institute staff, 556 proposals were sent to the members of the six panels set up for that time allocation process. The proposals added up to ten times the 1,230 hours of available HST observation time. From 24 to 27 April 1989, the panels met at STScI and ranked the proposals. Then the TAC met on 28 April to make a final allocation, taking into account the need to balance the various disciplines represented in the panels. The Institute Visiting Committee stated shortly after the TAC meeting that “the reviews were fair, and a successful effort was made to hold conflicts of interest to an acceptable (minimal) level.”²² A later review of the 165 accepted proposals identified some overlap between the accepted proposals and the observing plans of the Guaranteed Time Observers. This required adjustments to observations and policies since GTOs had priority over the other observers.²³

When HST was finally launched and its spherical aberration problem was discovered in June 1990, STScI worked with General Observers and GTOs to reassess and reorganize the first cycle observations to take into account Hubble’s diminished capabilities, which affected some instruments, such as the cameras, more than others, such as the spectrographs. The TAC was reconstituted and convened in February 1991 to reallocate observing time. Ten of the original 165 approved observing programs were withdrawn, while another 10 observers

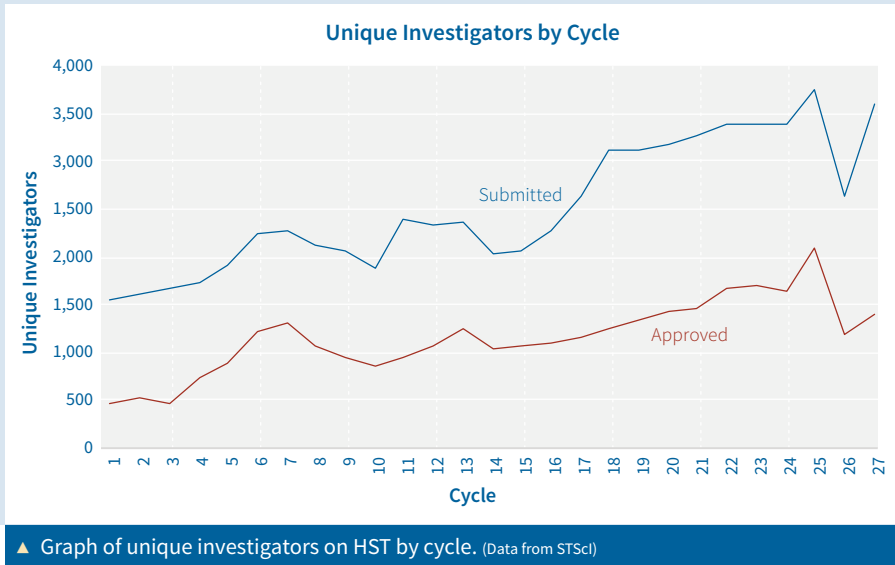

▲ Graph of unique investigators on HST by cycle. (Data from STScI)

requested significantly increased observing time, and a “relatively large fraction of the originally allocated programs could be retained for Cycle 1.”²⁴ NASA decided to create a new policy to deal with the problems that most Guaranteed Time Observers would face when trying to make observations with instruments affected by spherical aberration before Servicing Mission 1. After “much negotiation among many scientists,” NASA promulgated a compromise policy that allowed GTOs to postpone a limited number of observations to the period following SM1 and propose additional observations after SM1 that were subject to peer review.²⁵

HST observers faced new complications in September 1991 when part of the Goddard High Resolution Spectrograph failed. GHRS observations, which had not been greatly affected by spherical aberration, were put on hold until the following January. Cycle 2 observing proposals had been submitted in July and August of 1991, and the disciplinary panels and the TAC committee considered the new proposals in December, more than two-and-a-half years after the Cycle 1 proposals.²⁶ During the time that HST was affected by spherical aberration, demand for HST time fell off to 483 proposals for Cycle 2 in 1991 and 422 for the shortened (five-month) Cycle 3 in 1992. With SM1 in sight and observations set for the repaired HST, Cycle 4 received 501 proposals by the deadline in 1993, and the numbers continued to rise after the mission restored HST’s vision. Cycle 4 was lengthened to 15 months to accommodate SM1 in 1993, and its time allocations reflected the changed instruments on board HST after

that mission. Once normal operations began on HST in 1994, routine annual observation cycles for HST were established, punctuated by servicing missions in 1997, 1999, 2002, and 2009. Since the first servicing mission, STScI has received five or more times the number of observing proposals it can accept, accounting for between six to nine times the number of available HST orbits.²⁷

Although astronomers found many aspects of life with HST complicated, one change to astronomers' lives that came with Hubble was an unambiguous success. The NASA grant program for HST became so popular that it extended to other NASA observatories such as Chandra and Spitzer, and it accelerated a trend established in the 1980s where NASA replaced the National Science Foundation as the primary supplier of grants for astronomical research. These NASA grants for American observers and archival researchers using HST marked an advance over the previous model for independent observers, who had to apply for telescope time at a ground observatory or a space telescope like IUE, and then apply separately for funding from the National Science Foundation.

By combining the telescope time and the grant, the HST process avoided what STScI Director Ken Sembach called the “double jeopardy” of the traditional observing and grant process.²⁸ By 2000, the year of a National Research Council study into astronomy research funding, NASA supplied 72 percent of individual grants, and the HST grants program alone accounted for about 25 percent of all individual funding for astronomers in the United States. The study report also contained the following warning: “If a centerpiece astronomical research mission in space were to fail at a time when follow-on



▲ Kenneth R. Sembach, fifth director of STScI.
(STScI)

missions were far in the future, the impacts would include not only the loss of a major observational tool, but also the premature termination of the stream of research data and the flow of funds to analyze the data.”²⁹

NASA's financial support for astronomers went well beyond individual grants to observers. In 1990, with NASA's support, STScI launched the Hubble Fellowship Program. STScI selected Hubble fellows for three-year independent postdoctoral research programs relating to HST at institutions chosen by the fellows. NASA also embraced the concept, awarding Einstein and Sagan Fellowships starting in 2009. The Hubble, Einstein, and Sagan Fellowships were rolled into the NASA Hubble Fellowship Program starting in 2018 where the three fellowships are awarded in broad subcategories of scientific research. In addition to its involvement with grants awarded for HST observers and archival researchers, STScI operates academic programs such as a full library, visiting scientist, postdoctoral and graduate student programs, regular seminars, and scientific advisory committees that advised the director on recruitment, renewal, and promotion of its scientific staff.³⁰

CULTURE SHOCK

Outside of the small group of astronomers who had become familiar with HST during its development, many early users in the 1990s were unprepared for the demands of this new observatory. Journalist Stephen Cole described HST causing “a major culture shock” for astronomers accustomed to ground-based observatories, where last-minute changes were commonplace. “On the ground you have a lot of flexibility,” STScI astronomer Keith Noll said in 1992. “You can go up and change your mind at the last minute. And that’s just not the case here.”³¹ In the opinion of astronomer Robert Kirshner: “The paperwork associated with HST observing is somewhere on the scale of personal inconvenience between doing your tax return and enduring a root canal.”³²

Requests for time on HST always began with Phase I proposals focused on scientific justifications for evaluation by the review panels and the Time Allocation Committee. Approved proposals moved to Phase II where investigators provided complete details on their proposed observations, which allowed STScI to review each proposal for technical feasibility and schedule time for observation by specific instruments. Unites States investigators were eligible for funding by NASA, and observers requesting funding were required to submit a budget, although starting with Cycle 5, the budget was required only for successful proposals.³³

HST's observing schedule takes into account HST's location in low-Earth orbit. There is only a limited time in each orbit to view a particular target because Earth blocks much of HST's field of view. The telescope, when it slews from one direction to another, moves slowly, only six degrees per minute or roughly the same speed as a minute hand on a clock. So time is saved if observations

can be sequenced to minimize orientation changes. Unlike ground-based observatories, most HST observations are scheduled up to a month in advance and carried out automatically, often when the spacecraft is not in contact with the control center. It is possible to make an observation with HST requiring real-time aiming, usually when there are questions about the exact coordinates needed for an observation—for example, atmospheric phenomena on Jupiter or one of its moons—but these cases have been rare. STScI can schedule HST observations on short notice of less than a week when time is of the essence, as in the cases of Comet Shoemaker-Levy 9 and supernovae.³⁴

The process of requesting time on HST was especially burdensome in the early 1990s, before online forms and other electronic aids became widely available. In a 1992 article describing how astronomers worked with HST, Cole wrote that astronomers preparing proposals for Hubble were required to study manuals on HST operations and assemble evidence from other observations or simulations to demonstrate that the proposed project was feasible, required HST's unique features, and would advance scientific knowledge. "I can write a proposal for Kitt Peak [National Observatory] in an afternoon that's one page long," one observer complained to Cole. "Hubble requires four to five pages of text describing the program plus 10 pages of justification of why you want to use this scope and this instrument." Another said, "I was surprised at how long it took to prepare a proposal for Hubble."³⁵ An average observing proposal for HST involved a team of four scientists spending more than two person-years of effort, from the proposal through the observation and assessment of the data and publication of findings, Cole estimated. Once a proposal was submitted to the Institute and accepted, usually as part of the time allocation process, observers were assigned a technical assistant to help deal with the complicated problems involved with HST observations, such as being aware of instrument limitations or understanding the software used by HST. As part of their efforts with Goddard to streamline HST operations, STScI began work in 1999 on the Astronomer's Proposal Tool, which exploited advances in computing software to help astronomers better understand during the application process how HST's operations might affect their observing plans. The tool came into use during Cycle 12 in 2003, and it simplified and shortened the proposal process for astronomers.³⁶

Despite these new administrative tools for observers, the process of getting observing time on HST meant sometimes unwelcome changes for astronomers used to more flexible observing styles at ground-based observatories. University of Colorado astronomer Thomas Ayres compared the ease of changing IUE observations on the spot in real time with the lengthy process to get an HST

observation and the small likelihood of a second chance if the HST proposal contained an error, such as incorrect coordinates or exposure times. “It’s very hands-off. You have to make sure everything is right at the beginning, and then...hope for the best. But that hope has to be really tempered with a lot of upfront work.”³⁷ STScI astronomer Holland Ford saw the other side of the change, noting that the HST scheduling system used experienced operators who knew the instruments better than investigators who might be using HST for the first time. Many projects required optimum or special conditions, and the Institute’s queue scheduling system could better accommodate such requests. Ford added that more observing projects involved large numbers of astronomers who would have to leave the actual job of making the observations to an expert in any case.³⁸ No doubt as time went on, more astronomers became accustomed to the system used at STScI and increasingly by other observatories to organize observations from various astronomers.

Data downloaded from HST have always undergone initial processing at the Institute, but additional processing by the users was also required. Inexperienced observers were advised to complete the processing of their data at the Institute, where expert assistance was available. In 1992, observers were sent their data on magnetic tape, and as technologies advanced, data were made available on optical discs and then compact discs and DVDs. In later years, astronomers were informed by e-mail when their data were available, and then they would download it from the Hubble data archive.³⁹

AMATEUR ASTRONOMERS

While HST was being built, a number of people at NASA, Congress, and STScI discussed giving HST observing time to amateur astronomers. STScI Director Riccardo Giacconi, whose earlier scientific work on the Einstein X-ray Observatory had benefitted from observations made by amateurs of bright x-ray objects, was clearly a driving force behind the idea, and in December 1985, he invited leaders from seven national amateur astronomy organizations to the Institute. The seven leaders formed the Hubble Space Telescope Amateur Astronomers Working Group and created a plan that they presented to Giacconi. On 7 August 1986, at the Astronomical League meeting in Baltimore, Giacconi announced that the plan would go ahead, with up to 20 hours of observing time in HST’s first observing cycle coming out of Giacconi’s director’s discretionary time. “I expect that amateur astronomers will use the Hubble Space Telescope to ask refreshingly new questions and that your findings will, as they always have, make a real contribution to the advancement of astronomy. Rather than emphasize the differences between professionals and amateurs in a field such

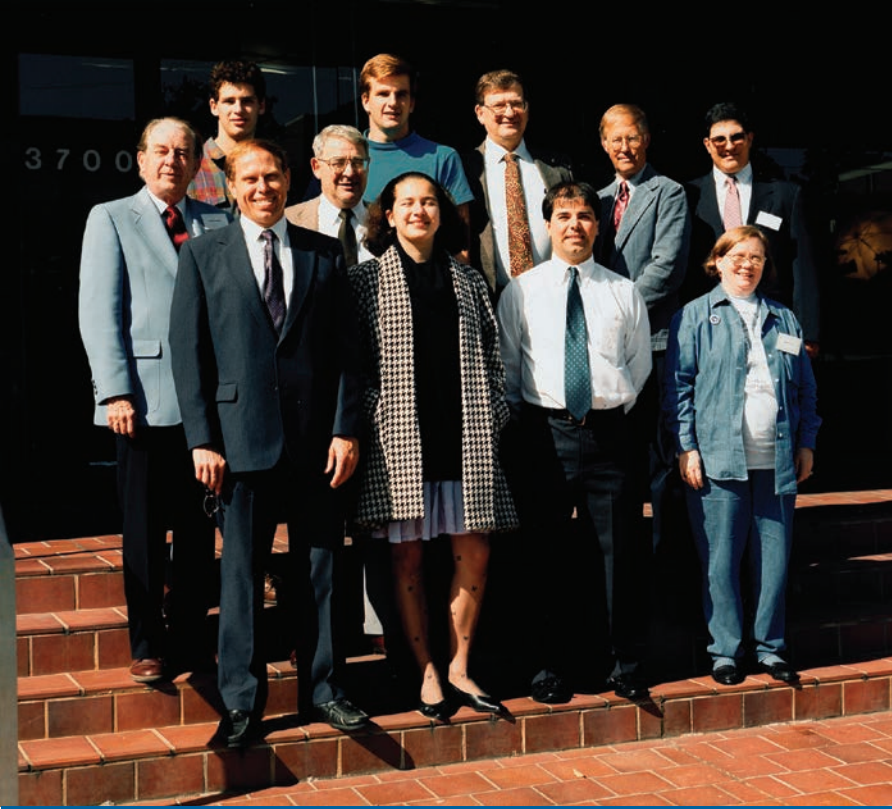

▲ Amateur astronomers chosen for HST observations in the second amateur cycle in 1993. Front row: James Secosky, Rukmini Sichitiu, George Lewycky, and Nancy Cox. Middle row: Lewis Thomas and STScI Director Riccardo Giacconi. Back row: Benjamin Weiss, Winslow Burleson, Karl Hricko, Harald Schenk, and Joseph Mitterando. (STScI)

as astronomy where the distinction is so thin, let us emphasize instead our common thirst for knowledge, our love of nature, and our appreciation of the beauty and mystery of the universe,” Giacconi told the meeting.⁴⁰

The working group evaluated the amateurs’ proposals based on scientific and educational merit, technical feasibility, the need for the unique capabilities of HST, and time demands on HST, and then passed them to Giacconi for final time allocation. Each successful principal investigator would be funded to visit STScI as their observations were conducted and would be entitled to assistance from Institute scientists. They would have proprietary rights to their data for one year and would be expected to write a paper on their results for a peer-reviewed journal in a similar manner to professional astronomers.⁴¹ In 1989, Giacconi announced that five amateur proposals would be given time on HST. The five selected amateur astronomers included a computer scientist, an engineer, a high

school science teacher, a homemaker, and a museum volunteer. Their proposals ranged from seeking massive proto-planets using HST, to observing galactic arcs, Jupiter's moon Io, a nova, and magnetic fields around peculiar stars. One of the five was cancelled because of HST's spherical aberration problem, and the other four proposals were carried out in 1992. In September 1992, STScI announced that another group of five amateur astronomers would get telescope time, and a third round followed later.⁴²

Eric J. Chaisson, who as head of the Institute's Public Affairs Office promoted the program, reported that some of the 200 amateur applications for the first round showed original thinking, while a few were best described as "ludicrous." The program met resistance from some professional astronomers who were concerned about limited time availability on HST, he said, and NASA took some time to warm to it. "In return, the chosen amateur astronomers became among the best ambassadors for the Hubble project."⁴³ One amateur, Ana M. Larson of Seattle, was taking astronomy courses after having worked in business and then raising her children. She won time on HST for an ambitious proposal to search for evidence of planets around other stars. Despite the fact that HST's spherical aberration prevented her from making the observations, she was so inspired by her Hubble experience, including a visit to STScI, that it served as a "kickstarter" for a career in astronomy. Larson went on to earn a Ph.D. in astronomy from the University of Victoria and became a lecturer in astronomy at the University of Washington.⁴⁴

But the program's low cost and public relations value weren't enough to save it. On 6 November 1995, Giacconi's successor as director, Robert Williams, cancelled the program, effective with the completion of three observing proposals from the third round of applications, which took place in 1996 and 1997. The amateur program saw a total of 12 observing proposals from amateurs carried out on HST. The cancellation of the program kept its total cost at \$31,000. Williams claimed that staff cuts at the Institute in 1995 and additional work needed to support the upcoming second Shuttle servicing mission meant "that we no longer have the staff" to be able to support amateurs "both before and after the observations."⁴⁵ Given that the money involved was a miniscule fraction of STScI's budget, the reason for the cancellation may have had more to do with the low interest amongst amateurs in HST time, or the new director's lack of interest in the program. *Sky and Telescope* magazine noted that out of the estimated 300,000 amateur astronomers in the United States at the time, the 200 proposals from 500 amateur astronomers for the first round was not a large number. The second round saw only 30 proposals and the third round six. Stephen J. Edberg, chair of the working group, blamed a lack of publicity

for these low numbers, along with the large amount of work required for each proposal. Despite their good ideas, Edberg asked, “Was it realistic to expect that amateurs could use a professional instrument without outside help? The answer is no!”⁴⁶

CONTINUOUS CHANGES

HST time allocations were changed several times over the years to reflect special circumstances, including problems with instruments or final observations for instruments about to go out of service. For example, most HST observations in late 1996 were dedicated to observers using FOS and GHRS before those instruments were replaced with STIS and NICMOS during Servicing Mission 2 in early 1997. Similarly, when it was discovered later in 1997 that the cryogen required to cool NICMOS was depleting much faster than expected, more time was granted to NICMOS investigators while work began on a new cooling system for the instrument. Because HST has unique capabilities in ultraviolet frequencies that won't be available when it ends operations, the Ultraviolet Initiative began with Cycle 21 in 2013 and has increased the share of HST time dedicated to UV observations.⁴⁷

Hubble's time allocation process also changed throughout its history for a number of other reasons, including changing observing interests amongst astronomers, alterations to HST itself, continued pressure for HST observing time, and the creation of complementary instruments in space and on the ground. STScI astronomer Neill Reid, head of STScI's Mission Office, said time allocation processes changed in response to input from users, panel and TAC members, and other Institute committees, especially the Space Telescope User Committee. The time allocation process for HST also benefited from the experiences of time allocation processes in other observatories, he said. TAC panel and committee memberships are changed each cycle with only about 10 to 15 percent of their memberships overlapping from one cycle to another. Most GTO observations were made early in HST's time on orbit, although new GTO Observations were granted when new instruments were launched on servicing missions to people who had worked to make the instruments possible.

Through the life of HST, STScI introduced changes to the variety of available observation times. In 1991, STScI introduced SNAP, or snapshot proposals, to HST's observing menu. These observations had to be completed within one orbit and could be scheduled for unused orbits between other observations. The Institute adjusted boundaries between large, medium, and small proposals several times over the years, mainly because of concerns about a lack of proposals for large observing programs. The large programs suffered because of the

narrow focus of early TAC panels, and the problem was resolved with a number of changes to the TAC process, including specifically allocating time for large programs and having the TAC committee review large proposals instead of panels. In Cycle 5, STScI changed observing allocations from spacecraft hours to orbits, where each orbit corresponded to 50 to 55 minutes, increasing the accuracy of resource-use estimates for proposals, and set the boundary between large and small proposals at 100 orbits, without medium proposals.⁴⁸ (See appendix B.)

In 2000, STScI created the Hubble Second Decade Committee to make recommendations to optimize HST science. It recommended that HST pursue multicycle Treasury programs to address “widely recognized scientific issues,” produce large data sets for archival research, and achieve economies of scale. The committee said HST had already made large-scale observations in the forms of its three Key Projects and the Hubble Deep Fields, both of which made “outstanding contributions” to HST Science. The report also noted that there were many theories about the low numbers of large observing programs up to that time, but said “a major proactive step” was needed to encourage them.⁴⁹ STScI introduced Treasury Programs in Cycle 11 in 2002 that required between 100 and 300 orbits of observing time over several observing cycles. Data from Treasury Programs became immediately available to all. After Servicing Mission 4 in 2009, the Institute began to authorize even larger Treasury Programs due to growing demand from the astronomical community.

Demand was also growing for observations that encompassed all wavelengths available from telescopes on Earth and in space. So starting in 2000 with Cycle 9, scientists could submit joint observing proposals involving HST and other observatories, including the National Optical Astronomy Observatory, National Radio Astronomy Observatory, Chandra X-Ray Observatory, Spitzer Space Telescope, and XMM-Newton X-Ray Telescope. Beginning in 2015, some orbits were set aside for General Observers to apply for small amounts of time to address scientific questions that required observations sooner than the next full call for proposals, enabling a faster turnaround for rapidly evolving or new science questions.⁵⁰

The Institute changed the structure of the panels in the TAC process over the years as scientific interests evolved and in order to minimize opportunities for conflicts of interest. When the panels for Cycle 24 met in June 2016, there were 15 panels, including one for the solar system, two for planets and planet formation, three for stellar physics, two for stellar populations, three for galaxies, two for black holes and their host galaxies, and two for intergalactic medium. The broad subject areas with multiple panels reduced the chances for

investigators to be on a panel judging their own proposals. By that cycle, paper had been almost eliminated from the TAC process, and all information was transmitted electronically to panel and committee members. Because of the large number of proposals, panel members considered proposals well before the formal meetings, issuing preliminary grades and eliminating weaker proposals so that the meetings could concentrate on fewer proposals.⁵¹

The TAC process involved many measures to prevent conflict of interest and reduce bias. Rules prevented panel members from voting on or taking part in decisions affecting their own proposals and those involving co-investigators, current or former advisors and students, relatives, competing proposals, or those with institutional or other ties. Personal identification on proposals going to panel and committee members was sharply reduced as one of several measures to combat bias against female and minority principal investigators. Panel and committee members were selected to ensure female and minority representation, and starting with Cycle 21, annual TAC meetings began with a talk on reducing bias in the process. All TAC panels and committee meetings were open to observers from NASA and ESA. Despite these measures, the Institute still found differences in the success rates of proposals led by male and female principal investigators. “We don’t know the cause, but unconscious/implicit bias may play a role,” STScI Director Ken Sembach said at the Cycle 24 TAC meetings.⁵²

An expert on issues of unconscious bias, Stephanie Johnson of the University of Colorado, sat in on the TAC process for Cycle 25 in 2017, which also produced higher success rates for proposals led by men than those led by women. She recommended that STScI implement a fully blind application process for HST time where the identities of all applicants and reviewers are kept anonymous. A working group and the Space Telescope User Committee approved the recommendation, and the dual-anonymous proposal system took effect for the first time in Cycle 26 in 2018. The results showed that proposals from male and female investigators had almost identical acceptance rates. Johnson noted that the discussions at the Cycle 26 TAC process had a different flavor from those in Cycle 25. After the success of the dual-anonymous proposal system of Cycle 26 was repeated in Cycle 27 in 2019, NASA decided to use this system for all NASA astrophysics observation programs.⁵³

DIVERSITY AND HST

HST’s high profile among scientists and the public meant that both STScI and NASA were motivated to encourage diversity in their workplaces. STScI’s work to remove biases against women astronomers in the Hubble time allocation

process was just part of a wider effort on the part of NASA, its contractors and other astronomical institutions to make astronomy more welcoming for women and minorities. The Institute, which had a particularly high profile in the effort to foster diversity, found that making workplaces welcoming for women and minority scientists is an ongoing process that requires continuing attention.

Even before HST was launched, STScI staff raised questions about the place of women and minorities at the Institute. In 1988, the Institute Visiting Committee called for an affirmative action program at STScI that was met with the response from STScI management that one was in place in accordance with the law. The following year, the committee noted, "The percentage of women in the organization is approximately 33 percent of the total complement, but among the science staff the ratio is much lower." Because one of the only two female scientists then at STScI was leaving that year, the committee called for a search for qualified women or minority candidates for open positions.⁵⁴ While STScI awarded three of 15 Hubble Fellowships to women and made a major effort to hire women in professional positions, including offering positions to three of four shortlisted women, only one woman accepted. The 1990 Visiting Committee report highlighted the issue of accommodating couples where both were professionals, and reported that the "lack of arrangements for day care, or for parental leave, might deter women from accepting jobs at STScI."⁵⁵ Although the Institute made progress on child care in 1991, the Visiting Committee complained that "there continue to be problems in successfully recruiting women and persons of color." Women represented only six percent of research astronomers at STScI, and women, and persons of color were under-represented in the ranks of senior management. This compared to a 1992 survey that found that 12 percent of working astronomers in the United States with Ph.D.'s were women.⁵⁶

STScI responded to pressures from AURA, the Institute Visiting Committee, and its own staff with a number of affirmative action measures, including more aggressive hiring policies and training programs to combat sexual harassment.⁵⁷ Its best-remembered action was a meeting held at the Institute on 8 and 9 September 1992 that arose from suggestions from staff at the STScI and from Goetz Ortel, then the President of AURA. "Women at Work: A Meeting on the Status of Women in Astronomy," featured papers on the past and present of women in science and was sponsored by STScI, NASA, AURA, the Maryland Space Grant Consortium, and the Computer Sciences Corporation, whose employees staffed some functions at STScI. The meeting built on work by the American Astronomical Society, which had established a working group in 1972 that grew into a permanent Committee on the Status of Women in Astronomy.⁵⁸



▲ Group photo of participants in *Women at Work: A Meeting on the Status of Women in Astronomy*, September 1992, at STScI in Baltimore, Maryland. (STScI)

The 160 participants at the meeting considered different topics when they were divided into 18 working groups, and the resulting ideas were then further discussed at the meeting's final session. After the meeting, STScI astronomers Meg Urry, Laura Danly, and Institute Associate Director Ethan Schreier, with the help of writer and educator Sheila Tobias, worked the recommendations into what is now known as the Baltimore Charter. (See appendix C.) The charter criticized existing recruitment and training systems and called for "a scientific culture within which both women and men can work effectively and within which all can have satisfying and rewarding careers." The charter promoted the idea that diversity contributes to excellence in science and called for actions to improve the place of women in astronomy and to promote minorities that are "even more disenfranchised." The document laid out steps to promote affirmative action and concluded, "Women want and deserve the same opportunity as their male colleagues to achieve excellence in astronomy."⁵⁹ The charter was signed by the participants in the 1992 meeting, endorsed by the board of AURA, and presented to the 1993 AAS meeting in Berkeley. Soon the Baltimore Charter became known as a landmark event in the history of women in astronomy in the United States, and a copy of the Charter was put on permanent display near the Institute's main entrance.⁶⁰

The progress made on affirmative action in the 1990s and the general good feeling at STScI generated by the success of HST appeared to lower the profile of concerns about affirmative action until 2001. That year the Institute Visiting Committee pointed to a large number of women leaving the Institute and suggested that STScI pay closer attention to the issue. As a result of these concerns, AURA's board of directors requested an external review of the status of women at STScI. The external panel given the job visited the Institute in 2002 and interviewed men and women who had left STScI or turned down a

job offer there. While women made up 15 percent of the Ph.D. staff at STScI in 1992, the number had fallen to 10.4 percent a decade later. Women scientists from outside STScI received a greater proportion of director's discretionary funds than their numbers might suggest, but were underrepresented in terms of awards given by the Institute and AURA. Women staff members were less satisfied than men and more likely to find the climate of the Institute unfriendly. When questioned about issues of gender bias, the attitude of STScI management "could be described as dismissive of both the issue itself and the concern of staff to these matters." The report said STScI had once been a leader in advancing women scientists, stating, "It is our conclusion that the Institute has substantially changed its character. Our extensive interviews revealed that a surprising proportion of STScI staff found the current scientific and working environment to be inhospitable to women." The report, which included critical references to director Steven Beckwith, blamed the problem on STScI leadership changing their focus from science to management.⁶¹ AURA supported the measures suggested by the panel, and Beckwith worked to improve the working climate at the Institute. Beckwith later recalled that male scientists had often used strong language to express differences of opinion over scientific matters, which made many women uncomfortable, and he tried to make meetings more civil. At the time of the panel's report, STScI was entering a period of turbulence that saw troubled relations with NASA Headquarters due to the cancellation of Servicing Mission 4. Beckwith, who had tried to account for women's concerns at the Institute but admitted that he didn't handle them "particularly well," stepped down as director of STScI in 2005.⁶²

His successor, Matt Mountain, saw the combative nature of traditional scientific debate as lying at the heart of the problem. "The pursuit of excellence was somehow associated with a 'harsh environment' as a natural by-product, or phrases such as 'survival of the fittest' were often used." While the competition involved in science must continue, Mountain emphasized in his communications to his staff that the harsh environment was excluding women and other people, and that henceforth, all groups and individuals must feel empowered. "So we basically started to change the culture over the course of four or five years. And today [in 2016], as you look at the Institute, half the recruits on the science staff are women. We have a better reputation, in fact."⁶³

Mountain set up a committee on the workplace and took care to listen to and act on its advice. He said that while STScI had many family-friendly policies, they were rarely used and not well known. Fathers never took family leave even though they were allowed to do so. Part of rectifying that problem involved having senior staff set good examples. "For example, I never attend

afternoon or evening meetings on Halloween, or travel on my kids' birthdays." Mountain said that above all, scientific leaders have a responsibility to change how science is done to make it more inclusive.⁶⁴ While a woman has yet to be named director of STScI, Deputy Director Kathryn Flanagan served as interim director in 2015 between the time that Mountain moved on to AURA and Ken Sembach became director later that year.⁶⁵

Many scientists who work on HST and other space telescopes are located at NASA's Goddard Space Flight Center. In 2009, Goddard hosted the third major conference on women in astronomy, following the 1992 meeting at STScI, and a second meeting at Caltech in 2003. Ed Weiler, then NASA's Associate Administrator for Science, welcomed participants by noting that he was hired by Nancy Roman, NASA's first Chief of Astronomy who has become known as the Mother of the Hubble Space Telescope. In turn, Weiler was able to hire and promote many women and minority scientists, and stressed the importance of supporting public outreach work with NASA's scientific missions. "One of the main goals of our outreach efforts is to inspire young people to think about getting into these fields where they may someday make huge contributions," he said. Anne Kinney, then director of the Solar System Exploration



▲ Matt Mountain, fourth director of STScI.
(STScI)



▲ Kathryn Flanagan, interim director of STScI, 2015. (STScI)

Division at Goddard and one of the conference organizers, told the meeting that more work needed to be done on issues facing gay, lesbian, bisexual, and transgender scientists, as well as and persons with disabilities. And while women scientists were present in large numbers at junior levels, they remained poorly represented at higher levels at Goddard. Nicholas White, director of the Sciences and Exploration Directorate at Goddard in 2007, explained that he was responding to a large number of retirements by ensuring that diversity was a priority in hiring their replacements. Of the 58 scientists hired in the preceding 18 months, 34 percent were women. Four of the new hires were African American—about seven percent. White said, “We have a problem: the pool is not big enough in the underrepresented groups. And so my second priority is making sure the pipelines of people coming into the work force are there for us to hire from.” White added that the environment at Goddard must enable these new hires to excel.⁶⁶

THE HST ARCHIVE

HST was created at a time when astronomical data were moving from photographic glass plates and film to electronic and digital formats, and these new technologies were already revolutionizing how astronomical data were obtained and distributed. Just as the change to digital files made data easier to share, the shift that started roughly two decades earlier from private observatories to larger facilities funded by taxpayers and open to large numbers of astronomers raised demand for astronomical data. Due to its expense, location and high profile, HST became the ultimate public observatory of its time. HST’s high profile guaranteed that its data would be sought by large numbers of scientists. The rise of the internet that coincided with the early days of HST increased the portability of data far beyond the imagination of the people who first began building Hubble in the 1970s.

Computers and digital data were coming into increasing use early in the 1960s as particle physicists began to require them to deal with increasing amounts of data generated by accelerators and other instruments. Astronomers soon followed with their own observations using telescopes and spectrographs. Even before HST was designed, NASA began working to gather and preserve scientific data collected by early satellites. In 1966, NASA set up the National Space Science Data Center at Goddard to archive both astrophysics and other space science data. Eleven years later, NASA set up the Astronomical Data Center with a mandate to collect and distribute astronomical catalogs, beginning the expansion of NASA’s archival facilities as it launched more space science missions.⁶⁷ The coming flood of data from space missions including HST

raised questions about how to handle it, and so in 1978 the Space Science Board of the National Academy of Science formed the Committee on Data Management and Science. When the committee reported in 1982, its recommendations included scientific control of data management and an emphasis on making data available to scientists not involved in gathering that data.⁶⁸

NASA decided that the archive for Hubble should be established at STScI rather than at the Agency's own National Space Science Data Center. Data archiving for HST also became a prime area of cooperation between NASA and the European Space Agency. The 1977 Memorandum of Understanding between ESA and NASA on the Space Telescope stipulated that a copy of the HST archive be set up at ESA's Space Telescope European Coordinating Facility (ST-ECF) near Munich, Germany, to make this data available to European astronomers. NASA also contemplated other archives for HST data in other locations outside the United States.⁶⁹

The work to create an HST data archive began before Hubble was launched, when NASA Goddard contracted Loral AeroSys to build the Data Archive and Distribution Service (DADS). When development problems with DADS delayed its activation to 1992, STScI developed an interim archive system, the Data Management Facility, with help from European astronomers at the ST-ECF and from the newly established Canadian Astronomy Data Centre (CADAC) at the Dominion Astrophysical Observatory in Victoria, B.C. The relationship between STScI, ST-ECF, and CADAC on the HST archive continued, with the Europeans and Canadians assessing new storage media and developing new interfaces between the data and data catalogues using the internet, although ESA's active participation in archival development ended in 2010 with the closure of ST-ECF.⁷⁰

Sharing and handling digital data was much different in the early 1990s than it was even a decade later. Observations were recorded, processed, and shared on optical discs, magnetic tape, and large mainframe computers. Soon better computers and more portable discs became available for these purposes. With these tools, which were cutting edge for their time, the work of storing, processing, indexing retrieving, and sharing the data was complicated and difficult. After some delays, DADS became fully operational and open to outside users in October 1994 after 880 gigabytes of data representing all of the HST data contained in the Data Management Facility were converted to data formats compatible with the FITS format and transferred on optical discs to the DADS system.⁷¹

STScI's first Director, Riccardo Giacconi, recalled that a major priority for him was ensuring that HST data provided to all observers were properly calibrated, a process that includes removing signatures from instruments on the

data, such as noise or defective pixels; correcting data to account for measuring instrument behavior at different temperatures or electronic gain; and flagging suspect data. To make calibration work, HST routinely makes calibration observations, which provide information on how HST and the individual detectors on its instruments leave their marks on data, how those effects change in different conditions faced by HST in space, and how those effects change over time. Giacconi argued that the calibration work done by STScI, though controversial at first, constituted a “paradigm shift in observational astronomy” that made data from HST available to many more scientists than was the case when investigators were responsible for calibrating their own data in their own ways. “The data from Hubble could then be used by different scientists for different purposes,” Giacconi explained.⁷² Calibrating all data from HST had the effect of speeding the diffusion and application of that data, and it simplified the comparison of the findings and interpretations arising from that data.

As discussed in chapter four, the internet arose in the 1990s along with new and more powerful computer software and hardware, combined with growing bandwidth available to computer users around the world.⁷³ STScI sought to exploit these improvements to assist astronomers using HST through initiatives such as the Project to Re-Engineer Space Telescope Observing (PRESTO) and Goddard’s Vision 2000 program. On the archival side, STScI began HARP, the Hubble Archive Re-Engineering Project, in 1996 with the goal of streamlining archive operations, improving online access, and reducing costs by moving to lower cost storage media. The Institute’s annual report for 1998 said that by the end of that year, the average data retrieval rate from the archive was two to three times the rate of data entry. The report contended that the HST Data Archive began a departure from the historical practice of using science data from telescopes just once, marking a change from the time when previous research findings had not been catalogued or made available in an easily accessible form. It should be noted that other observatories were also developing digital archives of their own at the time.⁷⁴

The digitization of data and the arrival of the internet made data sharing amongst astronomers much easier than in the past. The fact that much new data remained proprietary to investigators for a year after observations were made did slow the sharing of data. Robert Williams’ decision in 1995 to make the entire data set associated with the first Hubble Deep Field observations available to everyone immediately after it had been processed was a landmark decision in making astronomical data available to all. Increasing amounts of data obtained by HST and other observatories have become available upon receipt and processing.

All HST data became available online starting in 1998, and the STScI archive expanded to cover astronomical observations from other sources including the IUE, the Extreme Ultraviolet Explorer, digitized sky surveys, and radio data from the Very Large Array in New Mexico. As a result, the archive became known that year as the Multi-mission Archive at STScI (MAST). By 2002, the archive grew to 12 terabytes of data from 17 different missions and surveys.⁷⁵ In 2012, STScI renamed the archive the Barbara A. Mikulski Archive for Space Telescopes, in honor of the Maryland senator who strongly supported HST. By the end of HST's 25th anniversary year in 2015, MAST held more than 236 terabytes of data, with 116 TB of data from Hubble alone. The majority of papers written using HST data starting in 2007 were based on archival data and did not originate with the teams that submitted the original observing proposals.⁷⁶

A study of 6,703 HST papers in refereed journals from 1998 to 2008 showed that publication rates for archival data from HST increased steadily over that period. The study's authors argued that this growth in the use of the archive "is consistent with the hypothesis that an archive's productivity is proportional to the total data storage." The study's authors also argued that the archive has doubled the scientific productivity of HST.⁷⁷ Hubble archival data retrievals doubled after SM4 in 2009, and archival and partly archival articles exceeded GO articles from that point on. In 2016, the archive had more than 12,000 registered archive users from all 50 states and 85 countries. They had access to about 100 terabytes of HST data based on 1.2 million observations.⁷⁸

MAST expanded the reach of HST by allowing researchers to access data from individual astronomical objects at various wavelengths obtained by different instruments. This helped researchers keep track of the full range of observations on celestial objects, and helped classify objects in sky surveys. The growth of the Hubble archive, the larger MAST incorporating other data sources, and similar archives, opened the door to virtual surveys for rare objects. These archives offered large amounts of data acquired under reliable conditions, which was important for researchers trying to compare data sets.⁷⁹

In the early 21st century, astronomy was exploiting the exponential growth in computing power and sensor capabilities to move into an era of large surveys based on observations by spacecraft and instruments on the ground. Exploiting its experience that began with HST, in 2016 the MAST at STScI became the home of the public science archive for the Panoramic Survey Telescope and Rapid Response System (Pan-STARRS), a large ground-based survey of large areas of the sky, and was preparing for the massive amounts of data that expected to stream from numerous new spacecraft including JWST, TESS (Transiting Exoplanet Survey Satellite), and the Nancy Roman Space Telescope. TESS was

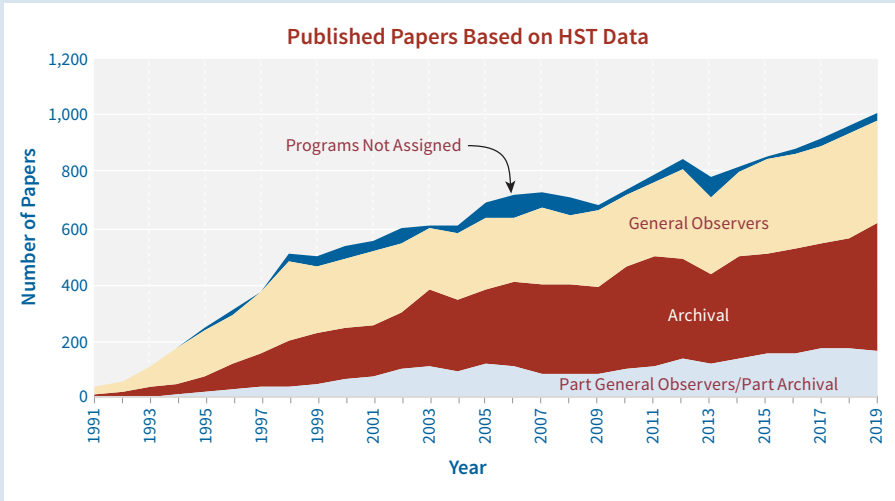

▲ Published papers based on HST data. Data are presented in appendix D.

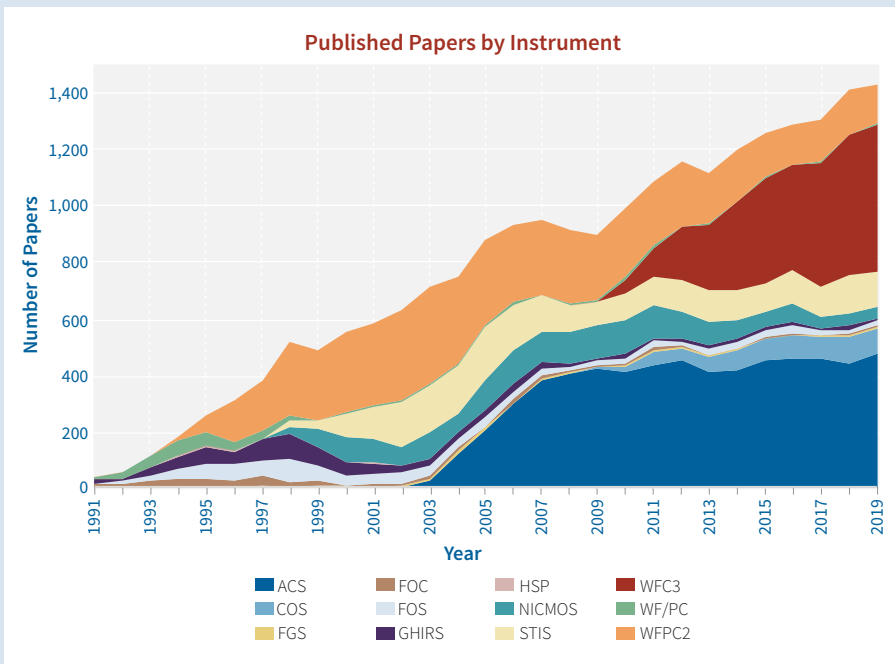

▲ Published papers by instrument. Data are presented in appendix D.

launched in 2018 to continue the search for exoplanets, and the Roman Space Telescope is planned to fly after JWST and perform wide-area infrared surveys of the sky to address the accelerating expansion of the universe and, using microlensing, to search for exoplanets.⁸⁰

ANOTHER OBSERVATORY

The Hubble data archive in effect became an observatory of its own that will continue to be used long after HST itself has ceased to function. Data are available in both raw and calibrated form, with the calibrations continually updated to reflect the latest technological advances and data analysis techniques. The universe changes over time, and the archive is a place where astronomers can go to follow those changes as seen in Hubble observations. “Because it’s a stable platform, it’s been there a long time, and has exquisite spatial resolution, you can see things change,” explained Canadian astronomer John Hutchings. “The supernova in 1987 in the [Large Magellanic Cloud], you can actually see the expanding nebulae around it. Novae that go off in the local galaxy, you can see the nebulae expanding. You can see planetary nebulae changing by taking pictures year after year and watching how it’s actually changed.”⁸¹ Advances in image processing allowed images gathered for one reason to be taken from the archive, reprocessed, and used for another purpose. For example in 2009, University of Toronto astronomer David Lafreniere used new processing techniques on NICMOS images taken in 1998 to identify an exoplanet that had gone undiscovered when the data were originally obtained. The exoplanet was discovered in 2007 and 2008 by the Keck and Gemini telescopes, and the reprocessed NICMOS images from a decade earlier increased astronomers’ knowledge of the planet. “The Space Telescope data is so homogeneous, and always taken under the same conditions, and the calibration is so good, that the archive has become a tremendous resource,” said Robert Kirshner. “So, lots of data that was taken for one purpose has been used again for another purpose.”⁸² Astronomer Sandra Faber said that HST, along with the Sloan Digital Sky Survey, has “brought the archive concept to full maturity.”⁸³

As time went on during the lifetime of HST, astronomers have come to recognize the importance of the archive. Thomas Ayres, for example, proposed and won what he called “no regrets” observing programs on STIS to ensure that certain types of ultraviolet observations were available in the HST archive for analysis when HST and STIS or an equivalent are no longer be available to make such observations.⁸⁴ As pointed out above, HST’s Treasury Programs have the goal of broadening the Hubble archive and preparing for the day when HST is no longer operating. The result of these HST observations is a massive

archive of data that will require decades of analysis. The fact that astronomers worked to make data from HST and other observatories available in common formats such as FITS vastly simplifies the task of scientists and even enthusiastic members of the public to use and understand the data, and to combine data from multiple observatories. The creation of massive astronomical data archives has resulted in astronomers never going to a telescope but instead becoming data miners.⁸⁵

The HST archive has reopened HST to amateur astronomers. The STScI's website, Hubblesite.org, includes a page to assist amateur image processors making use of HST image data.⁸⁶ Astrophotographer Robert Gendler, a physician by profession, took HST imagery of the M106 spiral galaxy and combined it with images he and fellow astrophotographer Jay GaBany obtained of the galaxy to create an image in 2013 with help from Institute personnel.⁸⁷ Large numbers of astronomy enthusiasts helped astronomers involved in the Panchromatic Hubble Andromeda Treasury (PHAT) search for star clusters in a series of images that resolved more than 100 million stars in the Andromeda galaxy. The PHAT images were obtained during two months of observations using HST's Advanced Camera for Surveys and Wide Field Camera 3. Julianne Dalcanton of the University of Washington, who leads the PHAT program, said her group had mixed results using students to search for and classify star cluster in the PHAT images. Chris Lintott, the Oxford astrophysicist, host of the BBC television show *Sky at Night*, urged the PHAT team to crowdsource this work through Zooniverse, an organization he founded dedicated to promoting citizen science. More than 10,000 volunteers helped out in the first round of image classifications and 5,000 in the second round. "People did such an amazing job," Dalcanton said.⁸⁸ This effort was just one of many citizen science projects facilitated by Zooniverse. Other citizen science projects related to HST included the Galaxy Zoo project, and the Hubble Hot Stars project, which both involved members of the public in classifying objects from HST and other observatories.⁸⁹

CHANGING ASTRONOMY

Many scientists accustomed to traditional astronomy see HST and other space-based observatories as causing "a major transformation in their practice of astronomy," according to historian W. Patrick McCray. "Scientific discoveries aside, astronomers saw Hubble affecting their field sociologically and culturally, particularly in the funding area." The funding model NASA first applied for Hubble eased the process of getting telescope time and funding by combining both needs into one transaction, which led to NASA supplanting NSF as the prime source of funding for United States astronomy.⁹⁰

The changes that HST has brought to astronomy have struck astronomers in different ways. Harley Thronson, who enjoyed his time alone with a telescope under chilly skies early in his career, found himself “underwhelmed” by the experience of HST despite its much higher efficiency and its unique capabilities. “But there is no romance, no emotion. I find it drier. Intellectually more exciting, because you get better data, but emotionally less fulfilling.”⁹¹ While many astronomers of Thronson’s generation agree, others appreciate the rise of teamwork in astronomy. Sandra Faber did not have such fond memories of being on her own in the observatory, and she began working to build research groups of astronomers even before HST flew. “I have found it extremely fun and interesting to work with large groups of people.”⁹² Indeed, HST and similar telescopes are attractive to astronomers who orient their careers to being part of teams. Randy Kimble, an HST Instrument Scientist at Goddard who helped develop WFC3, said project scientists have the opportunity to enable science. “I never would have been able to conceive of this instrument independently, or write the compelling proposal that got 200 orbits of Hubble time to be the lead of the Deep Field investigation. But as a part of this team of talented people, I could make a definite contribution to creating this instrument that does all this great stuff.”⁹³ The evidence that astronomy on HST is a team effort came quickly in the form of a study of highly cited papers based on HST data that appeared in *The Astrophysical Journal* between 1995 and 1998. The study showed that these papers had an average of 9.7 authors, 2.7 times more than the average of 3.6 authors for other papers from that time. “In many cases the team members represented many different institutions from many countries.”⁹⁴

The creation of massive archives such as MAST and those related to the great astronomical surveys means that growing numbers of astronomers are doing their work without reference to observatories or their own observations, as in the past. McCray has written about the larger groups of astronomers that have become involved in each discovery and each published paper, and how the shift of astronomical work from telescopes to archives has changed the nature of astronomy itself, making it more reliant on gigantic instruments and databases much like particle physics. Anthropologist Götz Hoeppe has written about how astronomers have shifted to laptop computers connected to the internet and away from observatories, and how astronomers use algorithms to help calibrate data but rely on their own knowledge gained from their own observations and experiences to verify data before reaching research conclusions.⁹⁵

The fact that STScI experts do most of the work between the time proposals are approved by the TAC process and the time the data are made available to investigators “removes the need to be a black belt” astronomer, explained Matt

Mountain. “So, the only requirement to get time on the Hubble is that you have a credible science idea, which is picked by peer review, and the complexity of the telescope and the data processing is hidden from you by this institution. As a result, you have a very large community that is now able to use the Hubble.”⁹⁶ Mountain also credited Giacconi with creating the “science systems engineering approach” that has opened astronomy up to the nonexpert and increases the scientific return from the very expensive facilities paid for by the public. Both Mountain and Giacconi compared this approach in astronomy to author Thomas L. Friedman’s claim that the world is being changed or “flattened” due to the growing ability of individuals with internet connections to participate in many activities previously closed to them. “In astronomy, we are creating a similar paradigm, where anyone with an internet connection can get access to fully calibrated data taken with the Hubble Space Telescope.” However, Mountain did share the concerns expressed by Giacconi and others about the growing separation between builders and users in astronomy.⁹⁷

For those involved with HST, even those who have had differences at times with the Institute, the scientific organization for HST has won praise. “Hubble is a superb observatory because it’s been run like an observatory, and you have thousands of astronomers from all around the world competing every year for who has the best ideas,” said David Leckrone, the longtime HST Senior Project Scientist. Speaking as HST marked 26 years in space, he said, “The demand for Hubble is still very high, and that means that for every one great idea, there are five that get rejected, and they’re still potentially great ideas. And so opening up the observatory to the world-wide community, and letting this be a marketplace of the best ideas, I think has gone a long way toward its success and the innovative science that’s come out of it, and continues to come out of it.” NASA adopted a model similar to STScI for the Chandra X-ray Observatory with the Chandra X-ray Center in Cambridge, Massachusetts, and the Spitzer Space Telescope with the Spitzer Science Center in Pasadena, California.⁹⁸

HST has been a leading force in causing changes in astronomy such as the shift to teamwork, the need for proposals for obtaining observing time, and the rise of data archives, but it wasn’t the only source of these changes. Observatories back on Earth are also instituting similar systems out of necessity. Even before 1990, radio astronomers had become familiar with receiving data obtained by others after waiting in a queue, and even some ground-based optical observatories were instituting such systems. When the two 8.19-meter Gemini telescopes in Hawaii and Chile began operations in 2000, they used queue systems and service observing, and these practices have spread to other observatories. McCray argued many of these changes were already underway

at ground observatories due to technological changes such as the digitization of data, and due to the need for greater efficiency as demand for telescope time grew.⁹⁹ HST Senior Project Scientist Jennifer Wiseman has argued that HST accelerated this movement in other observatories, saying, “Hubble was one of the pioneering facilities that by necessity forced astronomers to think about proposing and carrying out observations without actually, themselves, personally being there.”¹⁰⁰

The ranks of astronomers have grown around the world in the decades since HST was created, and many of the scientific problems that astronomers, physicists, and other scientists investigate have grown in complexity. Astronomy, a science that was once seen as a solitary pursuit, has become a team and in some cases even a mass pursuit. This change has been strongly facilitated by the creation of the internet, but as has been discussed here, HST’s time allocation procedures encouraged many investigators to work together to reach their research goals. NASA funding for American astronomers working with HST and other space telescopes has fostered the growth of the science in the United States. NASA’s decision to make HST observing time available to anyone regardless of where they live and subject only to the merit of their proposals confirmed the move to public observatories in astronomy. Even more importantly, the data obtained by HST are open for use by anyone who wishes to access it, much of it immediately after it has been obtained and processed, and this openness has spread to other observatories and institutions. The openness fostered by NASA and STScI with HST may ultimately be Hubble’s most important contribution to science.

ENDNOTES

- 1 Smith, *The Space Telescope*, pp. 375–388; Robert W. Smith, “The Biggest Kind of Big Science: Astronomers and the Space Telescope,” in *Big Science: The Growth of Large-Scale Research*, eds., Peter Galison and Bruce Hevly (Stanford, CT: Stanford University Press, 1992), pp. 184–211.
- 2 McCray, *Giant Telescopes*, pp. 290–294.
- 3 Edmondson, *AURA and Its US National Observatories*, pp. xxvii–xxviii, and McCray, *Giant Telescopes*, pp. 34–42; Alexander MacDonald, *The Long Space Age: The Economic Origins of Space Exploration from Colonial America to the Cold War* (New Haven, CT: Yale University Press, 2017).
- 4 Edmondson, *AURA and Its US National Observatories*; McCray, *Giant Telescopes*; Allan A. Needell, “Lloyd Berkner, Merle Tuve, and the Federal Role in Radio Astronomy,” *Osiris* 3 (1987): 261–288.

- 5 McCray, *Giant Telescopes*, pp. 267–268; Edmondson, *AURA and Its US National Observatories*, pp. 178–180.
- 6 McCray, “How Astronomers Digitized the Sky,” pp. 928–938 (quote from p. 937); Donald C. Wells, “The FITS Experience: Lessons Learned,” in *Information Handling in Astronomy—Historical Vistas*, ed., Andre Heck (Dordrecht: Kluwer Academic Publishers, 2011), pp. 65–72.
- 7 John Krige and Dominique Pestre, eds., *Science in the Twentieth Century* (London: Routledge, 2014), p. 637; Helmut A. Abt, “Is the Astronomical Literature Still Expanding Exponentially?” *Publications of the Astronomical Society of the Pacific* 110, no. 744 (February 1998): 210–213; American Astronomical Society, “What Is the AAS?” <https://aas.org/about/what-aas> (accessed 29 August 2017).
- 8 According to the American Institute of Physics report, Starr Nicholson and Patrick J. Mulvey, “Roster of Astronomy Departments with Enrollment and Degree Data, 2015,” there were 79 degree-granting astronomy departments in the US that year, about half of them stand-alone astronomy departments and the remainder astronomy and physics departments. See also Susan R. Trammell, “Astronomy Education in the United States,” in *International Symposium on Astrophysics Research and Science Education*, ed., C. D. Impey, Vatican Observatory, 1999, pp. 85–89.
- 9 T. P. Snow, “A Guide for Guest Investigators Using the Princeton Telescope on the Satellite Copernicus,” second edition, April 1975. Posted in the Mikulski Archive for Space Telescopes, http://archive.stsci.edu/copernicus/gi_guide/guide.html (accessed 7 August 2017); Smith, *The Space Telescope*, p. 343.
- 10 Albert Boggess, oral history interview by author, 21 September 2015, p. 1; Theodore Gull, oral history interview by author, 12 May 2015, pp. 2–4; Freeman Dyson, *From Eros to Gaia* (New York: Pantheon Books, 1992), p. 5; Yoji Kondo et al., “Astrophysical Contributions of the International Ultraviolet Explorer,” *Annual Review of Astronomy and Astrophysics*, 1989 27, pp. 397–420. IUE continued operations until it was shut down on 30 September 1996; Thomas Ayres, oral history interview by author, 23 September 2015, pp. 11–12.
- 11 Space Science Board, The National Research Council, *Institutional Arrangements for the Space Telescope: Report of a Study at Woods Hole, Massachusetts, July 19–30, 1976* (Washington, DC: National Academy of Sciences, 1976), pp. 8, 11, 12.
- 12 NASA, *Announcement of Opportunity for Space Telescope*, 18 March 1977, AO No. OSS-1-77, 7-9.
- 13 Kitt Peak began developing the Interactive Data Reduction and Analysis Facility in 1981 for reduction and analysis of astronomical data. Space Science Board, *Institutional Arrangements for the Space Telescope*, 20; F. Valdes, “The Interactive Data Reduction and Analysis Facility (IRAF),” 164th AAS Meeting, Baltimore, MD, 25.07, 1984; George H. Jacoby and Doug Tody, “The Use of the IRAF System at NOAO,” in Heck, *Information Handling in Astronomy*, pp. 73–92. See also McCray, “How Astronomers Digitized the Sky.”
- 14 NASA HST policy guidelines 1, 2, and 3 for STScI attached to letter from W. R. Lucas, Director, Marshall Space Flight Center, to Dr. Noel W. Hinners, Director, Goddard Space Flight Center, 3 July 1984. Archival Research would only be funded after going through

- a peer review process. See also STScI, *SO-20 Policies and Guidelines for the Use of the Hubble Space Telescope*, May 1993, SC193259A, in STScI Archive, Box 2.3, file “SO-20 Policies and Guidelines for the Use of the Hubble Space Telescope, May 1993,” JHU Library Special Collections
- 15 McCray, “How Astronomers Digitized the Sky,” p. 935; NASA, *International Ultraviolet Explorer Proposal Instruction Package for the Fifteenth Episode of the NASA IUE Guest Observer Program*, NASA Goddard Space Flight Center, September 1991, 14; Yoji Kondo and W. Wamsteker, eds., *Exploring the Universe with the IUE Satellite*. (Dordrecht: Kluwer, 1987), p. 27; Jeffrey S. Newmark et al., “A Summary of IUE Project Policies,” *IUE Observing Guide*, IUE Observatory and Computer Sciences Corporation, May 1992, http://archive.stsci.edu/iue/instrument/obs_guide/node49.html#SECTION00100000000000000000 (accessed 8 August 2017).
 - 16 Ed Weiler, “Question on the Origin of Grants to General Observers,” e-mail to author, 16 August 2017; Giacconi, *Secrets of the Hoary Deep*, pp. 236–237; Neta Bahcall, oral history interview by author, 31 August 2016, pp. 7–8.
 - 17 Riccardo Giacconi, “Notes for the CSAA Task Group for STScI,” 10 December 1984, from STScI Library, pp. 8–9. See also Neta Bahcall, OHI, 31 August 2016, pp. 2–3.
 - 18 Neta A. Bahcall, “The Hubble Space Telescope,” *Annals of the New York Academy of Sciences*, 470 (1986): 336.
 - 19 Neta Bahcall OHI, pp. 4–5. See also Giacconi, “Notes for the CSAA Task Group,” pp. 8–10.
 - 20 Bahcall, “Hubble Space Telescope”; Neta Bahcall, slides for Institute Visiting Committee Meeting, 10 May 1989; Neill Reid, “The Evolution of the *Hubble* TAC Process,” *STScI Newsletter* 30, no. 1 (2013), pp. 6–11.
 - 21 The figure of 3,500 orbits differs from the 1,230 hours available in Cycle 1 because of the higher efficiency of HST over time and the difference in observing time between an orbit and an hour.
 - 22 Riccardo Giacconi, *Annual Report to the AURA Board of Directors, Space Telescope Science Institute, April 1986* (Baltimore, MD: STScI, 1986), p. 13; Giacconi, *STScI 1989 Annual Report*, pp. 19–21; Neta Bahcall, presentation to Space Telescope Institute Visiting Committee, 11 May 1989, in documents of 1989 Institute Visiting Committee; Report of the Space Telescope Institute Visiting Committee, Seventh Annual Meeting, 17 May 1989. A search of meeting minutes and correspondence from that time did not turn up complaints of conflicts of interest arising from this process.
 - 23 Riccardo Giacconi, *Annual Report to AURA Board of Directors: Space Telescope Science Institute*, (Baltimore, MD: STScI, March 1990), pp. 10–11; Judy A. Rumerman, *NASA Historical Data Book, Volume V* (Washington, DC: NASA History Office, 1999), p. 523. See Glenn E. Miller and Mark D. Johnston, “A Case Study of Hubble Space Telescope Proposal Processing, Planning and Long-Range Scheduling,” 8th Computing in Aerospace Conference, Computers in Aerospace Conference, American Institute of Aeronautics and Astronautics, 1991.
 - 24 Riccardo Giacconi, *Annual Report to AURA Board of Directors: Space Telescope Science Institute*, (Baltimore, MD: STScI, March 1991), p. 10–11. Ken Carpenter communication with author, 12 October 2016, “I desopped my own GHRS GTO program, removing some

- targets to get more observing time for the remaining ones to make up for the lower transmission of the GHRS slits.”
- 25 “Policy 14: Revision of Guaranteed Time Observer (GTO) Award Due to Spherical Aberration,” in STScI, *SO-20 Policies and Guidelines for the Use of the Hubble Space Telescope*; e-mail from Al Boggess to Peter Stockman, “Policy 14,” 3 December 1990.
 - 26 Riccardo Giacconi, *Annual Report to AURA Board of Directors: Space Telescope Science Institute*, (STScI, Baltimore, MD, March 1992), pp. 10–11.
 - 27 Robert E. Williams, *Annual Report to AURA Board of Directors: Space Telescope Science Institute*, (STScI, Baltimore, MD), March 1994, p. 13; “Cycle 2 peer review underway,” *Space Telescope Science Institute Newsletter*, (November 1991), p. 19; “Cycle 3 proposal review completed,” *Space Telescope Science Institute Newsletter*, (October 1992), p. 17; “Cycle 4 proposal review completed,” *Space Telescope Science Institute Newsletter*, (September 1993), p. 15; Reid, “The Evolution of the Hubble TAC Process.”
 - 28 Jennifer Wiseman, oral history interview by author, 8 May 2015, p. 8; Ken Sembach, oral history interview by author, 25 May 2017, p. 14.
 - 29 Committee on Astronomy and Astrophysics, National Research Council, *Federal Funding of Astronomical Research* (Washington, DC: National Academy Press, 2000) quote on p. 2; Giacconi, *Secrets of the Hoary Deep*, p. 237. For more recent figures, see also Astronomy and Astrophysics Advisory Committee, “Completed Grant Success Rates in US Astronomy and Astrophysics,” 15 March 2016.
 - 30 Riccardo Giacconi, *STScI Annual Report 1992* (Baltimore, MD: STScI, 1992) pp. 29–36; NASA news release, “NASA Announces New Hubble Fellows Selected for 2018,” 3 April 2018; Giacconi, *Secrets of the Hoary Deep*, pp. 234–236; NASA, “NASA’s Carl Sagan Fellows to Study Extraterrestrial Worlds,” news release 08-218, 3 September 2008; “Einstein Postdoctoral Fellowship Program: 2009 Call for Proposals,” August 2008, <http://cxc.harvard.edu/fellows/CfP fellow.2009.html> (accessed 19 August 2019); Patricia “Padi” Boyd, oral history interview by author, 13 June 2016, pp. 12–13. The Einstein Fellowships were first awarded in 2009 and took the place of previously awarded Chandra and Fermi Fellowships.
 - 31 Stephen Cole, “Astronomy on the Edge: Using the Hubble Space Telescope,” *Sky and Telescope*, October 1992, 386–394. Quotes 386.
 - 32 Kirshner, *The Extravagant Universe*, p. 203.
 - 33 Cole, “Astronomy on the Edge,” p. 391. Before Cycle 5, budgets had to be submitted with Phase I proposals.
 - 34 *Ibid.*, p. 391; Kirshner, *The Extravagant Universe*, pp. 203–206. Kirshner discussed the additional complications of obtaining HST observations on short notice, noting that Tuesday was the best day of the week to make such a last-minute request to fit in STScI’s scheduling cycle for HST.
 - 35 Cole, “Astronomy on the Edge,” p. 391.
 - 36 Tony Krueger, “Astronomer’s Proposal Tools (APT) Project Management Plan,” STScI, 6 June 2000, <http://apst.stsci.edu/apt/documents/documentation/apt-project-plan-word.html> (accessed 30 August 2017); Duccio Macchetto, Robert Williams, and Brett Blacker,

- “HST Cycle 12 Proposal Peer Review,” *STScI Newsletter* 20, issue 3 (Summer 2003): 1, 3, 4; Thomas Ayres, OHI, p. 13; Cole, “Astronomy on the Edge,” p. 391.
- 37 Thomas Ayres, OHI, p. 13.
- 38 Holland Ford, oral history interview by author, 27 October 2015, p. 21.
- 39 Cole, “Astronomy on the Edge,” p. 394; STScI, “HST Data Handbook for WFPC2: Chapter 1: Getting HST Data,” http://www.stsci.edu/instruments/wfpc2/Wfpc2_dhb/intro_ch1.html (accessed 12 August 2017).
- 40 STScI, “History of the Project to Allocate Hubble Space Telescope Observing Time to Amateur Astronomers,” undated but probably 1986, in STScI Archive, Box 2.8, file “Press Releases/Fact Sheets, n.d., 1984-1991,” JHU Library Special Collections; STScI, “Amateur Astronomers to Have Observing Time on Hubble Space Telescope,” news release 86-03, 7 August 1986; Riccardo Giacconi, *Annual Report to AURA Board of Directors: Space Telescope Science Institute*, (STScI, Baltimore, MD, March 1987), p. 42; Wallace Tucker, “The Space Telescope Science Institute,” *Sky and Telescope*, April 1985, pp. 295–299. The seven leaders were Janet A. Mattei, director of the American Association of Variable Star Observers; John E. Westfall, acting director of the Association of Lunar and Planetary Observers; George Ellis, president of the Astronomical League; Jesse E. Eichenlaub, president of the Independent Space Research Group; Gerald Persha of International Amateur-Professional Photoelectric Photometry; David W. Dunham, president of the International Occultation Timing Association; and Stephen J. Edberg, president of the Western Amateur Astronomers, who also chaired the Amateur Astronomers Working Group.
- 41 STScI, *Hubble Space Telescope Handbook for Amateur Astronomers*, (Baltimore, MD: STScI, October 1986), p. 14.
- 42 STScI, “Amateur Astronomers Selected for Observing Time on NASA’s Hubble Space Telescope,” draft news release 89-05, undated. in STScI Archive, Box 2.8, file “Press Releases/Fact Sheets, n.d., 1984–1991,” JHU Library Special Collections; STScI, “Amateur Astronomers Will Use NASA’s Hubble Space Telescope,” news release 1992-23, 10 September 1992; STScI memorandum from A. Kinney to R. Williams, “Recommendation for the Final Cycle of Observations for Amateur Astronomers,” 29 September 1995, and STScI memorandum from Peg Stanley and Anne Kinney, “HST Amateur Astronomer Program Recommendations,” 3 November 1995, in STScI Archive, Box 1.3, file “DO Office Public Outreach, 1994–1996,” JHU Library Special Collections; Max Mutchler and Harald Schenk, “Amateur Astronomers and the Hubble Space Telescope,” 188th Meeting of the American Astronomical Society (AAS) in Madison, WI, 13 June 1996, and the 190th AAS Meeting in Winston-Salem, NC, 10 June 1997, <http://georgenet.net/hubble/bio/amateur.html> (accessed 19 July 2016).
- 43 Chaisson, *The Hubble Wars*, pp. 82–85.
- 44 Ana Larson, oral history interview by author, 28 November 2017, quote on 5.
- 45 Robert Williams e-mail to Stephen J. Edberg, “Amateur Program,” 5 January 1996, in reply to letter, Stephen J. Edberg, Hubble Space Telescope Amateur Astronomers Working Group, to Robert Williams, 30 December 1995, both in STScI Archive, Box 1.3, file “DO Office Public Outreach, 1994–1996,” JHU Library Special Collections; Williams

- notation on Stanley and Kinney, "Amateur Astronomer Program Recommendations"; and Mutchler and Schenk, "Amateur Astronomers and HST."
- 46 Stephen James O'Meara, "The Demise of the HST Amateur Program," *Sky and Telescope*, June 1997, 97–104. Quote on 102.
 - 47 Williams, *1997 STScI Annual Report*, p. 1; STScI, *Hubble Space Telescope Call for Proposals for Cycle 24* (Baltimore, MD: STScI, January 2016), pp. 58–59; Thomas Ayres, OHI, pp. 9–10.
 - 48 STScI, "NASA Hubble Space Telescope 'Snapshots' Probe the Early Universe," news release STScI-1992-03, 13 January 1992; Reid, "The Evolution of the *Hubble* TAC Process;" STScI, *Hubble Space Telescope Cycle 5 Call for Proposals* (Baltimore, MD: STScI, June 1994) 2.
 - 49 Hubble Second Decade Committee, *The Hubble Treasury Program: A New Class of Hubble Observations* (Baltimore, MD: STScI, 2000).
 - 50 Reid, "The Evolution of the *Hubble* TAC Process;" *Space Telescope Science Institute, Hubble Space Telescope Call for Proposals for Cycle 24*, (Baltimore, MD: STScI, January 2016), pp.10–38, 56–60.
 - 51 Claus Leitherer, *Cycle 24 Orientation* (Baltimore, MD: STScI, 5 June 2016); TAC Review Committee, *Review of HST Telescope Allocation Committee (TAC) Actions and Procedures Being Coordinated by STScI* (Baltimore, MD: STScI, June 2002).
 - 52 Ken Sembach, *HST Proposal Review June 5–10, 2016*, PowerPoint presentation. Leitherer, *Cycle 24 Orientation*; Karoline Gilbert, *Achieving a True Meritocracy: Reducing Bias in the Peer Review Process*, slides for presentation to TAC panelists and committee members, 5 June 2016. The author attended the meetings of the Cycle 24 TAC panels and committee meetings at STScI in June 2016 as an observer.
 - 53 The Cycle 26 TAC Process for HST took place later in 2018 and with a different focus than in previous years due to a plan to hold the first JWST TAC process earlier in the year, hence the caution about crediting the anonymous review process for the changes in acceptance rates. N. Reid, "Hubble Cycle 26 TAC and Anonymous Peer Review," *STScI Newsletter* 35, no. 4 (2018); and N. Reid, "Dual-Anonymous Proposal Workshop," *STScI Newsletter* 37, no. 1 (2020). See also Marina Koren, "Who Gets to Look Out to the Edge of the Universe?" 20 December 2018, <https://www.theatlantic.com>.
 - 54 T. M. Donahue, *Report of the Space Telescope Institute Visiting Committee, Seventh Annual Meeting, May 17, 1989* (Baltimore, MD: STScI), p. 16; T. M. Donahue, *Report of the Space Telescope Institute Visiting Committee, May 31, 1988* (Baltimore, MD: STScI), p. 10.
 - 55 *1990 Institute Visiting Committee Meeting* (Baltimore, MD, 9 May 1990), pp. 5–6. See also reply from STScI appended to report.
 - 56 H. Spinrad, *1991 Institute Visiting Committee Meeting* (Baltimore, MD, 20–22 May 1991), pp. 6–7; Ethan J. Schreier, "A Snapshot Survey of Women in Astronomy," in *Women at Work: A Workshop on the Status of Women in Astronomy*, eds., C. Megan Urry, Laura Danly, Lisa E. Sherbert, and Shireen Gonzaga (Baltimore, MD: Space Telescope Science Institute, 1993), pp. 57–62.
 - 57 Riccardo Giacconi, memorandum addressed to all staff, 11 July 1991; Giacconi, memorandum, "Sexual Harassment Complaint Procedure," 30 March 1992; Meg Urry,

- “Workshop on Women in Astronomy,” 30 July 1992, in STScI Archives, Box 2.7, files “Memoranda , 1991,” “Memoranda 1992,” JHU Library Special Collections.
- 58 Peter B. Boyce, “Some Statistics on Women in Astronomy,” in Urry et al., *Women at Work*, pp. 65–70. The publication is available online with other information at http://www.stsci.edu/institute/conference/wia/index_html#Preface (accessed 21 July 2016). The preface to the report notes that a decision was made to address the issue of women in astronomy and not the issue of persons of color because the organizers thought that the issues surrounding racial minorities were different from those involving women and would be best addressed in another forum. The meeting report is an excellent resource on the topic of women in astronomy and science up to that time. The AAS Committee on the Status of Women in Astronomy can be accessed at <http://www.aas.org/csua/#about>. See also *1992 Institute Visiting Committee Report*, 5–8 May 1992, (Baltimore, MD: STScI, 8 May 1992), pp. 8–10; H. S. Stockman, *Annual Report to AURA Board of Directors: Space Telescope Science Institute* (Baltimore, MD: STScI, March 1993), pp. 2, 56. See also Riccardo Giacconi’s opening remarks in *Women at Work*, pp. 3–4.
 - 59 STScI, “The Baltimore Charter: An Initiative to Improve the Status of Women in Astronomy,” news release 1993-12, 8 June 1993.
 - 60 News Release, “The Baltimore Charter.”
 - 61 Panel to Review the Status of Women at STScI, *Review of the Status of Women at STScI*, 24 October 2002 (Baltimore, MD: STScI, pp. 2, 14).
 - 62 Association of Universities for Research in Astronomy, *Status of Women at STScI: AURA Response to the Report of the Independent Review*, undated—probably late 2003; *Report of the Institute Visiting Committee for the Space Telescope Science Institute*, June 2003, Baltimore, MD, 16-1; Beckwith OHI, p. 21.
 - 63 Matt Mountain, oral history interview with author, 4 November 2016, pp. 16–17.
 - 64 Mountain remarks in Anne L. Kinney, Diana Khachadourian, Pamela S. Millar, and Colleen N. Hartman, eds., *Meeting the Challenges of an Increasingly Diverse Workforce: Women in Astronomy and Space Science, Proceedings from the Conference Held at The Inn and Conference Center, University of Maryland, University College, October 21–23, 2009* (NASA, Goddard Space Flight Center, 2010), pp. 77–78. See chapters seven and eight for more on STScI during the 2000–2005 time period.
 - 65 STScI, “Dr. Kathryn Flanagan,” <http://www.stsci.edu/~flanagan/> (accessed 31 August 2017).
 - 66 Weiler remarks in Kinney, Khachadourian, Millar, and Hartman, *Meeting the Challenges*, pp. 13–21; Kinney remarks at 5-10; White remarks at 205-207. For a tribute to HST and NASA’s efforts to hire African American and Hispanic American astronomers, see Dean Tapia, director, *Hubble’s Diverse Universe*, DVD, Boag’s Productions, 2010.
 - 67 Cynthia Cheung and David Leisawitz, “New Frontiers in NASA Data Management,” in *Information Handling in Astronomy*, ed., Heck, pp. 45–63; McCray, *Giant Telescopes*, pp. 292–294. NASA Goddard today maintains an extensive archive setup for all its space missions in the NASA Space Science Data Coordinated Archive.
 - 68 See “Data Management and Computation; Volume 1—Issues and Recommendations,” Committee on Data Management and Computation, Space Science Board, Assembly

- of Mathematical and Physical Processes, National Research Council, published by National Academy Press, 1982.
- 69 Hubble Second Decade Committee, "The Hubble Data Archive: Toward the Ultimate Union Archive of Astronomy" (Baltimore, MD: STScI, December 2000), pp. 6–8; NASA HST policy guidelines 3, "Foreign Data Coordinating Facilities," attached to letter from W. R. Lucas, Director, Marshall Space Flight Center, to Dr. Noel W. Hinners, Director, Goddard Space Flight Center, 3 July 1984.
 - 70 The contract to build DADS had originated with Ford Aerospace, which was sold to Loral in 1990. Giacconi, 1991 *STScI Annual Report*, pp. 2, 22–24; 1992 Institute Visiting Committee Report, 4; Second Decade Committee, "The Hubble Data Archive," pp. 8–10; Albrecht OHI, pp. 14–16; Giacconi, *Secrets of the Hoary Deep*, p. 234; Dennis Crabtree, Daniel Durand, and Andrew Woodsworth, oral history interview by author, 17 August 2017.
 - 71 Robert E. Williams, *Annual Report to AURA Board of Directors: Space Telescope Science Institute* (Baltimore, MD: STScI, March 1995), pp. 1, 33. All of the HST data available in 1994 could fit in the hard drive of the personal computer used by the author to write this book two decades later.
 - 72 Giacconi, *Secrets of the Hoary Deep*, pp. 232–234; STScI, *HST Call for Proposals for Cycle 24*, p. 17; Ethan J. Schreier, "HST Calibration," ESO Conference and Workshop Proceedings, 2–28 April 1995, Garching, Germany.
 - 73 See Paul E. Ceruzzi, *A History of Modern Computing*, Second Edition (Cambridge, MA: The MIT Press, 2003), and Christopher Gainor, "The Hubble Space Telescope in Cyberspace," *Quest: The History of Spaceflight Quarterly* 24, no. 2 (2017): 4–12.
 - 74 Space Telescope Science Institute, *Annual Report 1998* (Baltimore, MD: STScI, 1999), p. 7; Robert E. Williams, *Annual Report to AURA Board of Directors: Space Telescope Science Institute* (Baltimore, MD: STScI, March 1996), p. 16; Robert E. Williams, *Annual Report to AURA Board of Directors: Space Telescope Science Institute* (Baltimore, MD: STScI, March 1997), pp. 10, 15.
 - 75 STScI, *Annual Report 1998*, p. 34; Space Telescope Science Institute, *Annual Report 2001* (Baltimore, MD: STScI, 2002), pp. 48–49.
 - 76 Space Telescope Science Institute, *Annual Report 2012* (Baltimore, MD: STScI, 2013); Space Telescope Science Institute, *Annual Report 2015* (Baltimore, MD: STScI, 2016), p. 7.
 - 77 Daniel Apai et al., "Lessons from a High-Impact Observatory: The Hubble Space Telescope's Science Productivity between 1998 and 2008," *Publications of the Astronomical Society of the Pacific* 122, no. 893 (July 2010): 808–826. Quote from p. 824.
 - 78 John W. MacKenty, *Hubble Space Telescope Status: Cycle 24 TAC Presentation*, STScI, 5 June 2016.
 - 79 Hubble Second Decade Committee, "The Hubble Data Archive," pp. 13–21.
 - 80 Space Telescope Science Institute, *Big Data @ STScI: Enhancing STScI's Astronomical Data Science Capabilities over the Next Five Years* (Baltimore MD: STScI, 15 March 2016). See also Peter Tyson, "Astronomy & Big Data," *Sky and Telescope* (September 2016): 14–21. The Roman Space Telescope was previously known as the Wide Field Infrared Survey Telescope (WFIRST).

- 81 John Hutchings, oral history interview by author, 30 March 2015, pp. 26–27.
- 82 Robert Kirshner, oral history interview by author, 28 September 2016, p. 21; STScI, “Hubble Finds Hidden Exoplanet in Archival Data,” news release STScI-2009-15, 1 April 2009.
- 83 Faber OHI, p. 32,
- 84 Thomas Ayres OHI, p. 5–7.
- 85 John Wenz, “How Stargazing Became a Numbers Game,” *The Atlantic*, 21 May 2015.
- 86 Hubblesite, “Hubble Image Processors,” http://hubblesite.org/get_involved/hubble_image_processors/ (accessed 19 July 2016).
- 87 STScI, “Amateur and Professional Astronomers Team Up to Create a Cosmological Masterpiece,” news release 2013-06, 5 February 2013; Wenz, “How Stargazing Became a Numbers Game.”
- 88 Dalcanton, OHI, p. 18; Elizabeth Howell, “Your Help Needed to Study Andromeda Galaxy,” 10 December 2012, Space.com, <http://www.space.com/18818-andromeda-galaxy-crowdsource-study.html> (accessed 19 July 2016); The Andromeda Project, “Round 2 is Complete!” 30 October 2013, and “Round 2: Welcome Back,” 13 October 2013, <https://blog.andromedaproject.org> (accessed 19 July 2016); Wenz, “How Stargazing Became a Numbers Game.”
- 89 Zooniverse Projects, <https://www.zooniverse.org/projects?discipline=astronomy&page=1&status=live> (accessed 1 September 2017).
- 90 W. Patrick McCray, *Giant Telescopes*, p. 268.
- 91 Thronson, who later became HST Program Scientist at NASA Headquarters, remembered winter observing in the early 1970s at the Yerkes Observatory in Wisconsin, wearing overalls equipped with electrical heating elements to combat the cold. On an Arizona observing run, his plans were defeated by a display of Northern Lights followed by clouds. Observing, he recalled, involved “brewing coffee for the night, making sandwiches for the evening.” Thronson OHI, pp. 19–22.
- 92 Faber, OHI, p. 33.
- 93 Randy Kimble, oral history interview by author, 1 November 2016.
- 94 Helmut A. Abt and Sarah Stevens-Rayburn, “Publication Statistics for Recent Papers from the Hubble Space Telescope,” *Bulletin of the American Astronomical Society*, 34 (2001): 935–937.
- 95 McCray, *Giant Telescopes*, pp. 290–295; Götz Hoeppe, “Astronomers at the Observatory: Place, Visual Practice, Traces.” *Anthropological Quarterly* 85 (4) (2012): 1141–1160; Götz Hoeppe, “Working Data Together: The Accountability and Reflexivity of Digital Astronomical Practice.” *Social Studies of Science* 44 (2) (2014): 243–270.
- 96 Mountain, OHI, p. 4.
- 97 Matt Mountain, “Flattening the Astronomy World,” *Physics Today* (February 2014): 8–9. See also Thomas Friedman, *The World is Flat: A Brief History of the Twenty-First Century* (New York: Farrar, Straus and Giroux, 2005); Giacconi, *Secrets of the Hoary Deep*, p. 234.
- 98 David Leckrone OHI, 13 June 2016, pp. 33–34; STScI, *2001 Annual Report* (Baltimore, MD: STScI, 2002), p. 2.

99 McCray, *Giant Telescopes*, pp. 268–272.

100 Wiseman OHI, p. 8.



CONCLUSION

The World's Most Famous Telescope

▲ ACS's view of Cone Nebula (in NGC 2264) was taken in April 2002. (NASA/Holland Ford [JHU]/ACS Science Team/ESA: heic0206c)

This book was completed with the final chapter of the Hubble Space Telescope's operational career still unwritten. Instead, this account ends as HST was completing its third decade on orbit, twice the original plan to fly Hubble for 15 years. HST is late in its life but still operating at a high level. Large numbers of astronomers are still seeking HST observing time through HST's time allocation process in the hope of making further observations with the aim of refining and broadening our knowledge of the universe. HST is being used to obtain a more precise value for the Hubble constant, trace the evolution of dark energy, study galactic clusters to learn more about dark matter, and exploit gravitational lensing using these clusters to peer even deeper into space. HST continues to follow the evolution of galaxies and black holes, measuring stellar populations and intergalactic matter, and searching for the ingredients of life in atmospheres of exoplanets. Closer to home, Hubble is following changes in the outer planets of our solar system. HST is also gathering ultraviolet observations and other data for deposit in archives. It is working with Chandra and other observatories both in space and on Earth, and a major goal for HST remains to operate simultaneously with the James Webb Space Telescope for at least a year once JWST is launched.¹

Since the completion of Servicing Mission 4 in 2009, HST has been totally dependent on the continued healthy operation of its systems for its survival. Before SM4, Hubble had never gone more than seven years without a servicing mission, and this mark was exceeded following SM4 starting in 2016. HST's systems have generally operated well in the decade since SM4, but substantial



▲ Replica of Galileo's telescope in the flight deck of Atlantis during Servicing Mission 4 to the Hubble Space Telescope in 2009. (John Grunsfeld)

failures will afflict HST in the future. One of HST's six gyroscopes failed in 2011, and two more failed in 2018. The remaining three gyroscopes were built with features designed to enhance their lifetimes, but these instruments will not last indefinitely. NASA developed and tested improved algorithms and other measures when previous gyroscopes had failed before SM4 to allow continued if limited operation even with a single gyroscope, and these measures can be used after further gyroscopes fail. Hubble's three Fine Guidance Sensors are showing signs of degradation, notably the one that has been on board since HST was launched in 1990. One instrument, the Near Infrared Camera and Multi-Object Spectrometer, has not operated fully since 2008, and the Advanced Camera for Surveys and the Wide Field Camera 3 experienced service interruptions in 2019.² Detectors on HST instruments will become less effective with time as they wear out with more exposure to light. Radiation exposure will also cause HST components to degrade. Hubble suffers wear from temperature swings as it passes between the harsh daylight and shadow conditions on every orbit of Earth.³

NASA Goddard estimated in 2016 that without measures to control HST's reentry into Earth's atmosphere, its most probable reentry time would be 2036, with 2028 as the worst case. When HST approaches the time of a major system failure or reentry, NASA will be required under United States government

policy to ensure that it does not make an uncontrolled entry into Earth's atmosphere that could possibly endanger people on Earth. This means that NASA will be obliged to prepare a robotic vehicle to launch into orbit, rendezvous with the telescope, and then attach to the docking fixture affixed during SM4. The robotic vehicle will then either send HST hurtling to destruction at a predetermined point and time above an isolated part of an ocean, or boost HST into a higher orbit.⁴

While these options preclude bringing HST itself back to Earth for display in a museum, its instruments such as the Faint Object Spectrograph, the Wide Field Planetary Camera 2 that took many of its most famous images, and the COSTAR that was part of the fix to HST's spherical aberration, were returned to Earth during servicing missions and are now on display in the National Air and Space Museum in Washington, DC. The unused backup main mirror for HST and Hubble's Structural Dynamic Test Vehicle are also on display at the

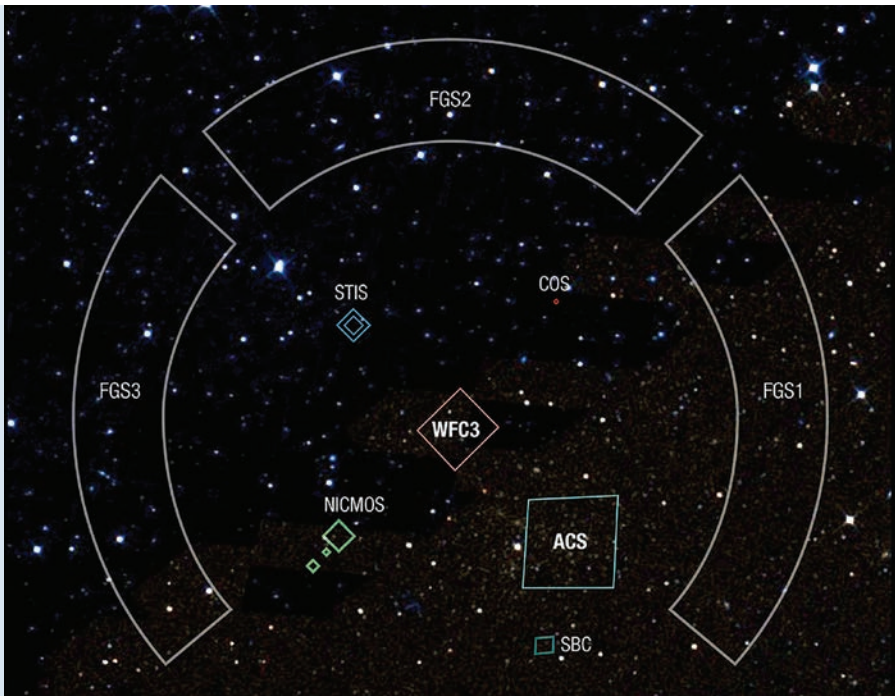

▲ Field of view "footprints" of HST instruments since Servicing Mission 4 in 2009. Instruments include Fine Guidance Sensors (FGS), the Near Infrared Camera and Multi-Object Spectrometer (NICMOS), the Space Telescope Imaging Spectrograph (STIS), the Cosmic Origins Spectrograph (COS), Wide Field Camera 3 (WFC3), and Advanced Camera for Surveys (ACS), which includes the Solar Blind Channel (SBC). (NASA/STScI)

Air and Space Museum. ESA's Faint Object Camera can be seen at the Dornier Museum in Friedrichshafen, Germany, and the High Speed Photometer is on show at the University of Wisconsin's Space Place in Madison, Wisconsin.⁵

Even after HST no longer operates and has fallen out of orbit, its mission will continue in the form of the data it has returned to Earth and is stored in archives located at STScI and elsewhere. Many HST observations that have not yet been examined by scientists have the potential of yielding important discoveries about the universe.

Hubble's three decades of operations have made major impacts on astronomy, space exploration, and the public. This study will conclude with some thoughts on these legacies, starting with space exploration. Because the life of HST has not concluded, there will be further events and more scientific findings to consider in the years to come.

HST AND THE SPACE SHUTTLE

The history of the Hubble Space Telescope is intertwined with that of the Space Shuttle. The Shuttle became the centerpiece of NASA's space programs when President Richard Nixon and Congress formally approved it in 1972, and soon it became the launch vehicle for the Space Telescope. While HST was being built, the availability of the Space Shuttle encouraged its designers to make it serviceable in orbit. In the words of Robert W. Smith, "The Shuttle, at least on the surface, had to a considerable degree merged the interests of the astronomers and NASA—the Shuttle provided the astronomers the capability to service the telescope in orbit, and for the Agency, the telescope provided a solid justification for, and added some much needed scientific legitimacy to, the Shuttle." The Shuttle's precipitously rising costs resulted in what Smith called in 1987 an "absurd situation" where the costs of the Shuttle servicing missions could have covered another space telescope.⁶ In the event, most of the financial costs of Shuttle missions to HST were charged to NASA human space programs rather than to HST, easing the financial impact on NASA's science budget and raising the question of whether that money could ever have been redirected to other science programs.

HST's ties to the Shuttle have imposed other costs. HST flew in an orbit that could be reached by the Shuttle, just 600 kilometers above Earth. Because of this low orbit, Earth blocked astronomical targets for roughly half of each 95-minute orbit on average, and HST's orbit often ran through the South Atlantic Anomaly, a dip in the inner Van Allen radiation belt that further limits the time during which HST's sensitive detectors can operate. The low orbit also placed extra demands on HST's pointing and control systems. As has been

noted, the thermal shock of passing in and out of darkness and solar illumination in each orbit stresses the telescope's thermal controls and outer skin.

The symbiotic relationship between HST and the Shuttle was epitomized by the five servicing missions that restored Hubble's failing systems and transformed it to a more powerful and effective telescope with new instruments. Thanks to the ingenuity of engineers and scientists, the first servicing mission to Hubble in 1993 installed fixes that overcame the spherical aberration inadvertently built into HST's main mirror. While only certain parts of the telescope were meant to be serviced, astronauts and NASA engineers proved that they could make repairs to HST that were not contemplated when the telescope was built. Their ingenuity was key to extending Hubble's lifetime long beyond the original plan for a 15-year mission.

Almost all spacecraft up to the present day can be classified as either human spacecraft or robotic. HST can be said to occupy a middle ground between the two, since it relied on five Shuttle servicing missions to keep operating after its deployment on another Shuttle mission. In one of his historic articles advocating spaceflight in *Collier's* magazine in 1952, Wernher von Braun envisioned a robotic space telescope dependent on human assistance in the form of astronauts changing its photographic film. Spaceflight advocates have since proposed many similar spacecraft, many but not all of them involving telescopes, that came to be called "man tended" and now "human tended."⁷ During the Shuttle Program, astronauts repaired several robotic satellites on single visits, but Shuttle crews serviced only HST on a regular and recurring basis. The Space Shuttle Program turned away from deploying and servicing satellites, starting with the Challenger disaster and concluding with the Columbia disaster, when the remaining Shuttle flights were dedicated to the International Space Station with the exception of HST Servicing Mission 4. Therefore, at the time of writing Hubble has remained the sole spacecraft that could be called human tended.

HUMAN SPACEFLIGHT OPERATIONS

HST's link to NASA's human space program means that Hubble has benefited from the glamor and human interest that comes with having astronauts involved with its operations. Astronauts like Story Musgrave, John Grunsfeld, and Mike Massimino have gained a measure of fame because of their work on HST servicing missions. Between his second and third missions to Hubble, Grunsfeld played a key role in overturning the decision to cancel SM4. Astronaut crews routinely visited Goddard and STScI as part of their work on servicing missions, and some of that work involved raising morale of workers on the ground before

and after the missions. Some astronauts became public ambassadors for HST, and years after the servicing missions concluded, astronauts still play prominent roles in anniversary celebrations for HST. Assignments to HST flights were coveted in the astronaut corps, especially for spacewalkers. One astronaut who did not fly to HST was quoted as saying, “Hubble guys are the Jedi. The coolest.” HST missions were also challenging for pilot astronauts, who had to fly the Shuttle to an orbital altitude greater than 600 kilometers, as high as the Shuttle could go, rendezvous with HST, and assist with the ambitious spacewalks.⁸

Hubble had an outsized impact on the course and perception of the Space Shuttle Program. The first Hubble servicing mission was critical for the continuation of the Shuttle Program and for restoring the Shuttle’s tattered reputation. It followed troubled satellite repair missions by Shuttle crews in 1984, 1985, and 1992 that showed the need for attention to detail and thorough preparation when servicing satellites. HST Servicing Mission 1 came at the end of 1993, a particularly troubling year for NASA. As outlined in chapter three, NASA’s difficulties included problems that delayed Shuttle missions, and ongoing questions about NASA’s long-awaited Space Station Program that brought it to the brink of cancellation. There was speculation in the media that another failure in space with the high-profile Hubble servicing mission could threaten the existence of NASA itself.⁹ The resounding success of SMI allowed the Shuttle and Hubble programs to continue, and gave the Clinton administration breathing room to reorganize the Space Station effort into the International Space Station Program with Russia and other international partners.¹⁰

Thanks to a great deal of preparatory work the HST servicing missions validated the spacewalking techniques and tools created to repair Hubble. The lessons of the first HST servicing mission not only led to successes in the subsequent servicing missions but also in the far larger job of using spacewalking astronauts and robotic devices to construct the ISS.¹¹ NASA astronauts and Johnson Space Center have maintained their expertise in building and servicing the ISS to the present day, and Goddard’s HST repair program has continued since the last HST servicing mission in the form of the Satellite Servicing Projects Division.

Starting with President George W. Bush’s Vision for Space Exploration in 2004 that followed the Columbia disaster the year before, NASA has been reorienting its human space program toward exploration beyond low-Earth orbit. To make this change possible within NASA’s budget, NASA brought the Space Shuttle’s 30-year run to an end in 2011. The ISS’s future beyond 2024 is not decided, and NASA does not have serious plans for a successor space station in Earth orbit. NASA and private contractors are now building a new

generation of human spacecraft that resemble the relatively small Apollo spacecraft that preceded the Shuttle. The future of missions that involve astronauts servicing satellites or constructing space stations remains open to conjecture, and with it the ultimate value of Hubble's contribution to satellite servicing.

HST AND SCIENCE

Most of HST's signature contributions to science have come in concert with other instruments on the ground and in space, as discussed in chapter six. In the most famous example, the bulk of the observations involved in the historic and surprising finding that the universe is expanding at an accelerating rate came from observatories on the ground, with HST data providing the final precise observations of supernovae needed to fine-tune the estimates on the size and age of the universe. HST data alone made possible the famous Hubble Deep Field observations, but now this set of observations and its successors have been complemented with data from other observatories in space and on the ground. HST was not used to discover exoplanets but it has provided important follow-up observations. As Robert Smith wrote in 2000, HST's main role "has been to contribute (sometimes with the aid of observations made by or in support of other telescopes) in very significant ways to a remarkably wide range of astronomical problems." He also noted that HST is only one of many telescopes playing important roles in astronomy today.¹² This study of HST's operations endorses these conclusions, but with a caveat. In the years in the third quarter of the 20th century when the great telescope on Mount Palomar dominated astronomy, the field was much smaller than it became by the time HST was launched. Due to the larger number of astronomers in the time of the Hubble Space Telescope, and the information technologies that came into use during that time, many more astronomers dealing with more different astronomical questions can use HST in their work than the small group of astronomers who were granted access to the Palomar telescope. While the larger number of other observatories might limit HST's influence over astronomy today, this is counterbalanced by the far greater availability of HST data, coupled with HST's unique capabilities that cannot be matched by observatories on Earth or even by upcoming space telescopes such as JWST.

As the end of HST operations approaches, astronomers are making observations in ultraviolet wavelengths that will no longer be available when HST ceases to observe. Other astronomers will miss having a telescope above the atmosphere that operates in visible light at the theoretical diffraction limit. JWST will work only in infrared wavelengths, and there are no firm plans at present to build a space telescope that would operate in the visible and ultraviolet

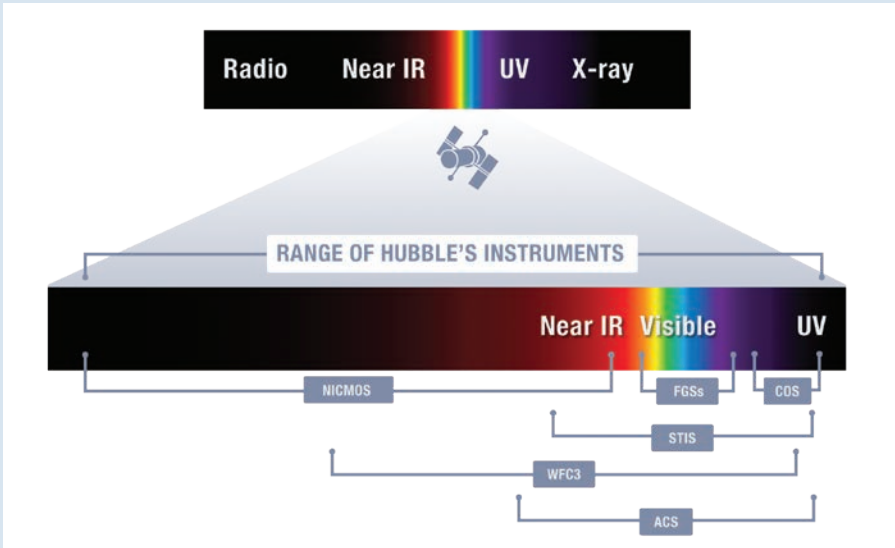

▲ Observable wavelengths for HST instruments since Servicing Mission 4 in 2009. Instruments on board HST are the Fine Guidance Sensors (FGS), the Near Infrared Camera and Multi-Object Spectrometer (NICMOS), the Space Telescope Imaging Spectrograph (STIS), the Cosmic Origins Spectrograph (COS), Wide Field Camera 3 (WFC3), and Advanced Camera for Surveys (ACS), which includes the Solar Blind Channel (SBC). (NASA/STScI)

wavelengths accessible by HST. Telescopes on the ground fitted with adaptive optics that compensate for atmospheric turbulence can only view small parts of the sky and are restricted to the limited wavelengths of light not blocked by the atmosphere. The end of HST will be a loss for many astronomers.

What made HST unique was not that it was the first telescope to operate in space. A number of telescopes had flown before it, though none had gained wide public awareness. Hubble’s popularity and importance stem from the fact that it was the first large telescope in orbit that could image in a wide range of wavelengths, from ultraviolet through visible and into the infrared. This capability allowed it to captivate the public, and it also changed the way scientists understood astronomical objects. The famous “Pillars of Creation” image, for example, was one of many HST images that have increased astronomers’ understanding of how stars are born. Thanks to Hubble, solar system astronomers have been able to keep track of changes taking place on the outer planets and many other objects in the solar system. And HST’s longevity has allowed it to follow changes in the wider universe, the best-known example being the 2014 image of the Eagle Nebula, which revealed changes that had occurred since the original “Pillars of Creation” image 19 years earlier.¹³ In a more general sense,

Hubble gave many astronomers their first clear view of the universe. In the words of HST Senior Project Scientist Jennifer Wiseman, Hubble “transformed the scale of the kinds of questions that astronomers could expect to address, because Hubble had such a profound improvement on an angular resolution and sensitivity from the previous telescopes, that it enabled different kinds of questions to be asked and addressed through observation.”¹⁴

HST has become famous for its scientific productivity. By 2019, more than 16,000 papers in refereed scientific journals relied directly on Hubble data, with roughly 800 new refereed papers appearing each year in journals. About one in five papers in major astronomical journals in recent years have been based on or have been influenced by HST observations, and one quarter of astronomy and astrophysics Ph.D.’s awarded each year rely on Hubble data for at least part of their conclusions. Papers using Hubble data have been cited more than 800,000 times.¹⁵



▲ Two images from the Wide Field Camera 3 of the “Pillars of Creation,” in M16, the Eagle Nebula, taken in 2014, one in visible wavelengths, the other in infrared. These images, released in 2015 to celebrate HST’s 25th anniversary, show changes from the original 1995 image of this area. (NASA/STScI/ESA)

HST's scientific successes have helped astronomers build political support for new telescopes on the ground and in space, especially the James Webb Space Telescope. HST's success not only maintained support for new projects within the American astronomical community but amongst astronomers the world over, all of whom were welcome to submit proposals for observing time on HST and make use of data from Hubble's archives. The international dimension of HST was symbolized in the European Space Agency's sponsorship of Hubble alongside NASA, and ESA's contributions to building, repairing, and maintaining HST and analyzing, curating, and publicizing its findings. HST has contributed to the growing multinational flavor of astronomy.

One of the most frequently invoked superlatives used to describe HST was most eloquently expressed when the crew of STS-125 serviced Hubble for the final time. The astronauts carried with them a replica of Galileo Galilei's historic telescope, and the presence of the replica on board their Shuttle Atlantis implied that HST represented a leap in viewing power and scientific potential comparable to the first telescope used to record scientific observations of the heavens.¹⁶

The span of four centuries between Galileo and HST makes any comparison problematic, however. One of the many major differences between the two time periods is that only a handful of people did any serious work on astronomy and physics in Galileo's time, while tens of thousands of people backed up by major intellectual, institutional, and financial resources are exploring and thinking about the universe in the time of HST. The scope of astronomy has expanded from visible light four centuries ago to the full electromagnetic spectrum today. The relationship between HST and Galileo resembles more a branch on a tree than a step on a ladder. HST sees the universe in optical and part of the infrared and ultraviolet parts of that spectrum, and its findings are being combined with other data obtained using observatories observing radio waves and high-energy wavelengths including x rays, gamma rays, and neutrinos. In 2017, physicists using specially built detectors widened the field of observation when they got the first views of gravitational waves generated by the merger of two neutron stars.¹⁷ Observations in various wavelengths have all led to important discoveries, but scientists can obtain a more complete idea of physical processes by observing in as many wavelengths as possible. While astronomy in various wavelengths outside of visible light began well before HST was launched, Hubble's prominent role in advancing and popularizing digital detectors, and encouraging collaboration amongst astronomers, catalyzed studies involving multiple wavelengths. The turn to coordinating observations of objects using instruments operating in different wavelengths is another example of how HST has played a major role in encouraging teamwork in astronomy and changed how astronomy is done.

The fact that HST is still returning data from space, and that many of its findings remain to be analyzed by scientists, leaves open the possibility that HST's most important discoveries are yet to come. The astronomers and the instruments that follow HST may build on Hubble's findings or overturn them, along with our view of the heavens. Some of the data upcoming instruments and investigators generate will no doubt be combined with Hubble data.

Historians of science have been strongly influenced in recent decades by the ideas of Thomas Kuhn, who argued that change comes to scientific beliefs in the form of paradigm shifts, as in the case of the shift from Newtonian physics to Einsteinian physics. Astronomers have answered many puzzling questions using HST and other instruments in the last 30 years, but newer questions have taken the place of the old ones, notably the two distinct problems of dark matter and dark energy.¹⁸ The answers that arise to those problems, and the timing, nature, and sources of those answers, will likely decide HST's place in the history of astronomy. In the meantime, it is difficult to dispute that in its first three decades of operation, HST has helped transform humankind's knowledge of the universe. The universe now appears more colorful, complicated, and stranger to humankind than it did when HST first took to the skies.

HST AND THE PUBLIC

The explosion in computing power and the arrival of the internet in the 1990s opened up HST and its archive to astronomers everywhere, and HST images became a staple of the internet starting from its early days to the present. Once it began producing high-quality images following the first servicing mission, and made them all easily accessible on home computers and then smartphones, HST caught the public imagination unlike any previous astronomical instrument. Telescopes that had come before, notably the Mount Wilson and Mount Palomar telescopes, became famous because of their sizes, and later on, the discoveries they facilitated. But the fame of those telescopes did not match that of HST. Neither telescope produced the bounty of images associated with them in the public mind in the same way HST has.

The discovery of spherical aberration early in its flight in 1990 caused Hubble to become a byword for failure. Less than four years later, after the first Shuttle servicing mission, NASA revealed the first photos that met HST's promise of stunning views of the universe. Soon the "Pillars of Creation" image and the "Hubble Deep Field" cemented HST's public reputation as humanity's window on the universe. Although many HST images speak for themselves, NASA, ESA, and STScI have also worked hard to promote the work of Hubble with extensive public outreach and education efforts. Hubble's passage through the wilderness

of public disapproval in the time of its spherical aberration also curbed the reluctance of many astronomers to share their discoveries with the public.

Ken Carpenter, a longtime HST Operations Project Scientist at Goddard, who lived through the dark days of spherical aberration as a member of the first-generation GHRS Instrument Definition Team, has learned in his many public appearances that people love HST. "It's become, in a sense, the people's telescope," he said, echoing Senator Barbara Mikulski, a powerful supporter of HST.¹⁹ Hubble's images have become a ubiquitous part of modern life. "It's been in dance; it's been on music albums; we've seen things like people have their guitars painted with Hubble imagery; you can buy clothing now, leotards and dresses and blouses come emblazoned with full-resolution HST images. It's just, literally, everywhere."²⁰

In 2004, when NASA Administrator Sean O'Keefe cancelled Servicing Mission 4, a move that heralded the end of HST, "there was a lot of pressure from the public, as well as from the astronomical community," Carpenter said.²¹ Many members of the public made known their displeasure by e-mailing NASA officials and members of Congress. Many supporters of the Hubble Space Telescope became known as "Hubble Huggers."²² Eventually, this public pressure and Shuttle safety measures allowed O'Keefe's successor, Michael Griffin, to restore the servicing mission, vastly extending HST's lifespan. "I think Hubble really changed the public's perception, made many more people aware of astronomy, interested in astronomy, excited by astronomy, fascinated by the images that were coming down," said astronomer Wendy Freedman.²³

Through most of its operational lifetime, the Hubble Space Telescope has operated in a shower of superlatives, starting with those expressed in expectation before its launch and followed later by the praise that followed its amazing images and surprising discoveries. Even the criticisms leveled at HST and its builders before its vision was corrected had an outsize quality to them.

Before HST was launched, many of its supporters predicted that it would challenge the imaginations of scientists with surprising findings about our universe. Nearly 30 years of HST operations have validated those predictions. The universe looks much different today as a result of HST's findings, and even members of the public unfamiliar with cosmology and space science have been deeply impressed with Hubble's trove of spectacular images. On the way to delivering its scientific bounty, HST challenged the imaginations of those who built it when a serious flaw in its main mirror was overcome by sheer force of human ingenuity. Hubble's longevity has exceeded the hopes of those who supported it when a political judgment that nearly cut short its operational life was overturned by popular reaction unprecedented for a robotic vehicle. And HST may not yet be finished surprising us.

ENDNOTES

- 1 NASA, *2016 Hubble Space Telescope Senior Review* (Washington, DC: 8–10 March 2016); NASA, *2019 Astrophysics Senior Review—Hubble Report* (6–9 May 2019).
- 2 Jim Jeletic, “Long Live Hubble,” *Air & Space Smithsonian* 33, no. 6 (December 2018/January 2019): 18, 20; NASA news release “Hubble’s Wide Field Camera 3 Recovered, Collecting Science Data,” 17 January 2019; NASA news release, “Hubble’s Advanced Camera for Surveys Resumes Operations,” 6 March 2019.
- 3 John W. MacKenty, “Hubble Space Telescope Status: Cycle 24 TAC Presentation,” STScl, 5 June 2016.
- 4 NASA, *Hubble Space Telescope Disposal Study* (Washington, DC: November 2012).
- 5 See David H. DeVorkin, “Epilogue: Exhibiting the Hubble Space Telescope,” in Launius and DeVorkin, *Hubble’s Legacy*, pp. 131–150. Much of the original Wide Field/Planetary Camera was recycled for use in WFC3, but its optical channels are located at the National Air and Space Museum. Much of the Goddard High Resolution Spectrograph was recycled for use in the Cosmic Origins Spectrograph.
- 6 Smith, *The Space Telescope*, pp. 393–395.
- 7 Dr. Wernher von Braun, “Crossing the Last Frontier,” *Collier’s*, (22 March 1952): 24–29, 72–74. Robert Smith discusses “man-tended” telescopes in *The Space Telescope*, pp. 45, 63–73. Roger D. Launius, and Howard E. McCurdy in *Robots in Space: Technology, Evolution and Interplanetary Travel* (Baltimore, MD: The Johns Hopkins University Press, 2008), p. 12, discuss HST and the Space Shuttle in the context of cooperation between humans and robots in space. During the early years of the U.S. Space Station Program that led to the International Space Station, a number of free flyer robotic spacecraft were proposed and abandoned, such as the ESA’s Columbus Man-Tended Free Flyer, which ultimately led to the Columbus module on the ISS.
- 8 Mike Massimino, in his book about his two HST missions, quoted astronaut Robert Curbeam about HST crews. Massimino, *Spaceman*, p. 151. Massimino and Musgrave have developed post-astronaut careers speaking about their experiences in space. Kathryn Sullivan, who flew on the HST deployment mission in 1990, has written a memoir centered on her work with HST, *Handprints on Hubble*. While researching this book, the author has seen former astronauts who flew on HST missions take prominent roles at anniversary and other events at Goddard and STScl.
- 9 Dennis Overbye, “Hubble Jeopardy,” *New York Times Magazine* (28 November 1993); Frank Kuznik, “The Must-Win Mission,” *USA Weekend* (26–28 November 1993).
- 10 Tatarewicz, “HST Servicing Mission,” pp. 388–389; Robert W. Smith, “Ten Years and Counting: HST in Orbit,” *Sky & Telescope* (April 1990): 28–34.
- 11 Tatarewicz, “HST Servicing Mission,” pp. 380–381, 394.
- 12 Smith, “Ten Years and Counting,” p. 34.
- 13 Hammel OHI, part 2, pp. 5–8; STScl, “Hubble Goes High Def to Revisit the Iconic ‘Pillars of Creation,”” news release STScl-2015-01, 5 January 2015.
- 14 Wiseman OHI, p. 8.

- 15 “HST Reports,” <https://archive.stsci.edu/hst/bibliography/pubstat.html> (accessed 24 August 2019).
- 16 IYA2009 Updates, “Galileo’s Telescope Back from Space: STS-125 Mission Astronauts on Visit to Florence, December 18,” 25 November 2009, <https://www.astronomy2009.org/news/updates/list/49/index.html>; See also this NASA/STScI website, which makes the comparison between Galileo and HST in terms of leaps in resolving power: Hubble-site, “Resolution 101,” http://hubblesite.org/the_telescope/nuts_and_bolts/res101.php (both accessed 5 September 2017).
- 17 Calla Cofield, “How Gravitational Waves and ‘Multi-Messenger Research’ Will Change Astronomy,” 17 October 2017, <https://www.space.com>. The gravity wave observations of the neutron star merger took place simultaneously with astronomical observations of the event in a variety of wavelengths of light.
- 18 Thomas Kuhn, *Structure of Scientific Revolutions* (Chicago, IL: University of Chicago Press, 1970); Martin Harwit, *Cosmic Discovery: The Search, Scope and Heritage of Astronomy* (New York: Basic Books Inc., 1981), p. 57; James A. Marcum, “The Revolutionary Ideas of Thomas Kuhn,” *Times Literary Supplement* (17 January 2018).
- 19 Kenneth Carpenter, oral history interview, 30 April 2015, part 1, 12; NASA, “Sen. Mikulski Unveils First Images from Rejuvenated Hubble,” news release 09-205, 9 September 2009.
- 20 Carpenter OHI, part 1, 14.
- 21 Ibid.
- 22 David H. DeVorkin and Robert W. Smith, *The Hubble Cosmos: 25 Years of New Vistas in Space* (Washington, DC: National Geographic, 2015), p. 14.
- 23 Wendy Freedman, oral history interview by author, 6 September 2017.



APPENDICES

▲ Hubble image of the Keyhole Nebula within the Carina Nebula (NGC 3372) taken in 1999.
(NASA/ESA, and The Hubble Heritage Team [AURA/STScI]: opo0006a)

APPENDIX A

HST FUNDING SUMMARY

The Hubble Space Telescope received formal approval from the administration and Congress to start in Fiscal Year 1978. Funding categories for HST changed in FY 1989 in anticipation of its launch, which took place during that fiscal year, and in FY 2006. Allocations for Shuttle servicing missions ended in FY 2009, the year of the final servicing mission to HST. The funding data were supplied by NASA Headquarters.

▼ HST funding summary since new start, science only (in millions of real year dollars).

	Technology	Develop- ment	Ground Systems	Operations/ Servicing Missions	Data Analysis/ Research	Servicing Missions	Operations	TOTAL
FY 75	3.0							3.0
FY 76	7.0							7.0
FY 77								
FY 78		36.0						36.0
FY 79		79.2						79.2
FY 80		112.7	1.8					114.5
FY 81		120.8	6.7					127.5
FY 82		121.5	13.2					134.7
FY 83		184.6	29.8					214.4
FY 84		203.1	34.0					237.1
FY 85		215.6	54.1					269.7
FY 86		153.9	55.8					209.7
FY 87		151.6	41.7					193.3
FY 88		144.3	48.0					192.3
FY 89		104.9		88.5	9.8			203.2
FY 90		81.8		139.1	13.3			234.2
FY 91				186.0	35.9			221.9
FY 92				207.7	36.0			243.7
FY 93				216.7	42.4			259.1
FY 94				215.2	38.5			253.7
FY 95				236.7	37.7			274.4
FY 96				190.7	43.5			234.2
FY 97				213.7	40.9			254.6
FY 98				180.4	39.5			219.9
FY 99				196.1	33.7			229.8
FY 00				185.6	68.4			254.0
FY 01				181.0	75.4			256.4
FY 02				175.2	80.7			255.9
FY 03				145.5	83.1			228.6
FY 04				155.6	87.0			242.6
FY 05				220.2	76.5			296.7
FY 06						183.6	78.6	262.2
FY 07						191.5	86.0	277.5
FY 08						153.7	83.4	237.1
FY 09						135.9	67.2	203.1
FY 10							100.7	100.7
FY 11							91.6	91.6
FY 12							98.3	98.3
FY 13							93.3	93.3
FY 14							98.3	98.3
FY 15							98.6	98.6
FY 16							98.3	98.3
FY 17							97.3	97.3
FY 18							98.3	98.3
FY 19							98.3	98.3
TOTAL	10.0	1,710.0	285.1	3,133.8	842.3	664.8	1,288.2	7,934.1

▼ HST funding summary since new start, science only (in millions of FY 2019 dollars).

	Technology	Develop- ment	Ground Systems	Operations/ Servicing Missions	Data Analysis/ Research	Servicing Missions	Operations	TOTAL
FY 75	14.3							14.3
FY 76	31.4							31.4
FY 77								
FY 78		141.1						141.1
FY 79		278.8						278.8
FY 80		349.4	5.6					355.0
FY 81		339.4	18.8					358.3
FY 82		322.0	35.0					357.0
FY 83		474.4	76.6					551.0
FY 84		499.6	83.6					583.3
FY 85		513.1	128.8					641.9
FY 86		358.6	130.0					488.6
FY 87		341.1	93.8					434.9
FY 88		311.7	103.7					415.4
FY 89		216.1		182.3	20.2			418.6
FY 90		160.3		272.5	26.1			458.9
FY 91				349.7	67.5			417.2
FY 92				378.0	65.5			443.5
FY 93				383.5	75.0			458.6
FY 94				372.3	66.6			438.9
FY 95				397.7	63.3			461.0
FY 96				310.8	70.9			381.7
FY 97				339.8	65.0			404.8
FY 98				283.2	62.0			345.2
FY 99				300.0	51.6			351.6
FY 00				274.7	101.2			375.9
FY 01				260.6	108.6			369.3
FY 02				248.8	114.6			363.4
FY 03				202.2	115.5			317.8
FY 04				210.1	117.4			327.5
FY 05				288.4	100.2			388.6
FY 06						233.2	99.8	333.0
FY 07						235.6	105.8	341.4
FY 08						182.9	99.2	282.1
FY 09						161.7	80.0	241.6
FY 10							117.9	117.9
FY 11							104.5	104.5
FY 12							109.1	109.1
FY 13							102.6	102.6
FY 14							106.2	106.2
FY 15							106.5	106.5
FY 16							105.2	105.2
FY 17							101.2	101.2
FY 18							98.3	98.3
FY 19							98.3	98.3
TOTAL	45.7	4,305.7	675.9	5,054.8	1,291.3	813.4	1,434.4	13,621.2

APPENDIX B

EVOLUTION OF PROPOSAL RATE AND ACCEPTANCE RATE FOR HST OBSERVING PROPOSALS

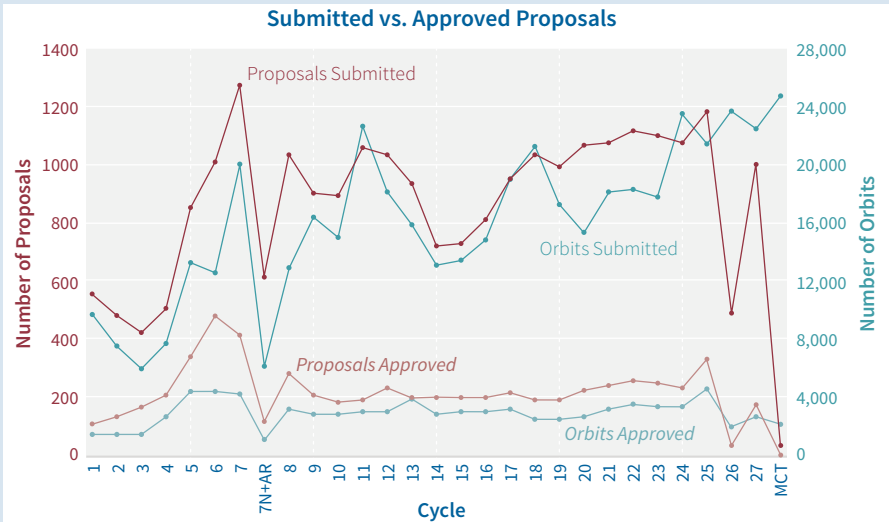

- ▲ Graph showing the number of submitted proposals versus approved proposals, as well as the number of orbits submitted in HST-observing proposals versus approved proposals for Cycles 1–27. Data are shown on the following page. Information provided by the STScI.

Notes: MCT was the call for very large multi-cycle treasury (MCT) proposals that STScI issued after Servicing Mission 4 in 2009. 7N and 7AR were special calls for NICMOS observing and archival proposals after an instrument fault was identified that limited the time that it would be available before its coolant ran out. In Cycles 25 and 26, STScI adjusted the allocations for those two cycles since it expected to be hosting the JWST Cycle 1 TAC in June 2018. The Cycle 25 Call also allocated time in Cycle 26 for small proposals. As a result, the Cycle 26 Call was only for medium and large proposals.

▼ Number of proposals for Hubble Space Telescope time submitted and approved for Cycles 1–27. Information provided by STSci.

Cycle	Approved proposals	Submitted	Approved orbits	Submitted orbits
1	112	556	1,346	10,732
2	141	483	1,380	8,169
3	173	424	1,455	6,303
4	216	501	2,835	8,289
5	352	863	4,574	14,272
6	496	1,025	4,600	13,543
7	424	1,298	4,400	21,734
7N+AR	119	617	1,041	6,473
8	295	1,053	3,300	14,005
9	212	914	2,866	17,690
10	193	906	2,920	16,236
11	198	1,078	3,130	24,667
12	242	1,046	3,150	19,674
13	209	949	4,036	17,257
14	209	727	2,948	14,190
15	203	733	3,223	14,581
16	203	821	3,164	16,078
17	228	960	3,411	20,630
18	196	1,050	2,578	23,096
19	199	1,007	2,554	18,659
20	231	1,085	2,802	16,681
21	248	1,094	3,308	19,742
22	263	1,135	3,707	19,900
23	261	1,115	3,563	19,301
24	245	1,094	3,560	25,611
25	340	1,205	4,900	23,365
26	40	489	2,077	25,775
27	182	1,019	2,686	24,454
MCT	4	39	2,262	26,801
7N	75	448		
7AR	44	169		
TOTAL	6,434	25,286	87,776	507,908

▼ Proposals by continent/region. Information provided by STSci.

Continent/Region	Proposals
United States of America	19,097
Canada and Mexico	409
North America	19,506
Europe	3,430
South America	186
Africa	24
Australia	247
Middle East	102
Asia	1,731

▼ Proposals: HST time by country. Information provided by STSci.

Country	1	2	3	4	5	6	7	7N	8	9	10-16	Sum	16S	17	18	19	20	21	22	23	24	25	26	27
Argentina	4			1	0	0	0	0	0	0	2		0									1		
Armenia	1			1	0	0	0	0	0	0	0		0											
Australia	243	3	2	3	10	12	14	5	12	16	60		3	11	15	12	14	12	15	13	5	3	3	
Austria	44	1	1	1	1	0	0	1	2	9		0	0	1	2	1	2	1	5	5	10	1	3	
Belgium	66	4	1	1	2	2	3	0	1	0	18		2	6	4	3	4	3	2	2	1	2	4	
Brazil	31			1	1	2	2	2	4	2	8		0				2	2	2		1	1	1	
Canada	361	8	4	9	24	26	31	9	19	18	81		2	15	12	13	8	12	15	14	11	6	9	
Chile	143			2	2	2	2	1	4	0	24		4	4	7	9	12	14	15	12	10	3	6	
China	57	1		0	0	2	0	2	0	1	1		1	0	1	4	1	4	7	10	8	8	7	
Columbia	1																							
Czech Republic	17														1	3	2	1	1	4	3	2		
Denmark	67	1			0	2	1	2	4	6	4		0	6	6	4	3	5	5	6	2	5		
Finland	24			1	2	0	2	0	0	0	7		0	1	0	1	2	2	1	1	2	2		
France	569	22	19	9	23	26	33	37	13	37	22	123	5	19	16	23	25	22	24	25	20	11	5	10
Germany	969	25	20	16	18	42	46	78	31	52	46	198	8	32	38	33	33	44	37	41	42	46	11	32
Greece	9			1	0	0	0	0	1	1	4		0	1	1									
Hungary	1																							
Iceland	1																							
India	26	1	1	1	0	2	2	0	2	1	11		0	2	1	1	1	1	1	1	1	1	1	
Ireland	32	1		1	0	0	0	0	0	1	13		5	2	2				4	1	1	1	1	
Israel	101	1	1	1	1	6	3	7	3	8	4	16	1	2	5	5	7	5	3	8	4	6	1	4
Italy	586	19	17	18	9	20	25	33	11	25	20	130	7	16	28	19	23	16	34	23	22	30	11	30

continued ▼

▼ Proposals: HST time by country. (continued)

Country	1	2	3	4	5	6	7	7N	8	9	10-16	Sum	17	18	19	20	21	22	23	24	25	26	27	
Total Submitted	114	1	34	48	4	11	9	7	39	1	24	262	182	172	6	355	1	8	1,494	19,097	3	4	1	
Japan	2	1	1	4	3	3	9	1	5	5	10	9	9	10	12	10	6	10						
Kazakhstan	1	0	0	0	0	1	0	0	0	0	0	0	0	0	0	0	0	0						
Korea	0	0	0	0	3	0	7	1	0	4	4	5	4	4	1	1	1	1						
Mexico	1	1	1	3	4	4	2	0	1	8	3	2	3	2	1	1	3	1	1	3	1	5		
New Zealand	4	1	1	1	1	0	0	1	0	0	1	0	0	0										
Norway	11	1	0	0	0	1	0	2	0	0	2	1	1	1	1	1	1	1	1	1	1	1	1	
Poland	9	0	0	0	0	0	2	1	2	1	2	2	1	2	1	1	2							
Portugal	7								2				2	1	2									
Russia	39	2	0	1	0	0	1	7	1	2	3	3	3	3	5	3	4	2						
Serbia	1																						1	
South Africa	24	3	1	4	2	3	0	1	0	1	1	0	6	2										
Spain	262	2	4	2	2	10	18	6	8	13	66	8	19	11	14	11	11	10	13	7	11	4	12	
Sweden	182	3	4	2	1	5	4	13	3	14	8	36	3	4	6	6	5	9	11	11	12	6	10	
Switzerland	172	3	3	2	2	6	5	4	2	3	4	26	1	7	6	2	6	8	11	11	13	19	18	
Taiwan	6										1	2	1	2										
The Netherlands	355	7	5	7	10	18	13	23	10	18	11	63	4	10	11	16	20	17	12	13	19	25	8	15
Turkey	1													1										
Ukraine	8										1	0	0	0	1	1	1	1	1	2	1	2	1	2
United Kingdom	1,494	16	15	21	21	58	79	105	39	70	57	316	14	51	65	58	65	59	72	74	74	86	28	51
United States	19,097	377	374	333	340	627	747	911	306	760	676	5,002	213	758	788	761	817	835	842	803	796	881	376	774
Uruguay	3														1	1	1							
Venezuela	4										3	0	0	0	1									
Yugoslavia	1										0	0	0											
TOTAL	25,230	481	483	447	863	1,025	1,298	449	1,053	914	6,259	277	958	1,050	1,007	1,090	1,094	1,134	1,115	1,094	1,208	489	1,019	

APPENDIX C

THE BALTIMORE CHARTER FOR WOMEN IN ASTRONOMY

The Baltimore Charter for Women in Astronomy

“Women Hold up Half the Sky” —Chinese saying

Preamble

We hold as fundamental that:

- Women and men are equally capable of doing excellent science.
- Diversity contributes to, rather than conflicts with, excellence in science.
- Current recruitment, training, evaluation and award systems often prevent the equal participation of women.
- Formal and informal mechanisms that are effectively discriminatory are unlikely to change by themselves. Both thought and action are necessary to ensure equal participation for all.
- Increasing the number of women in astronomy will improve the professional environment and improving the environment will increase the number of women.

This Charter addresses the need to develop a scientific culture within which both women and men can work effectively and within which all can have satisfying and rewarding careers. Our focus is on women but actions taken to improve the situation of women in astronomy should be applied aggressively to those minorities even more disenfranchised.

Rationale

Astronomy has a long and honorable tradition of participation by women, who have made many significant and highly creative contributions to the field. Approximately 15% of astronomers worldwide are women but there is wide geographical diversity, with some countries having none and others having more than 50%. This shows that scientific careers are strongly affected by social and cultural factors, and are not determined solely by ability.

The search for excellence which unites all scientists can be maintained and enhanced by increasing the diversity of its practitioners. Great discoveries have always occurred in times of cross-cultural enrichment: along trade routes, in

periods of geographical exploration, among immigrants and multinationals. The introduction of new approaches frequently results in new breakthroughs. Achieving such diversity requires revised, not lesser, criteria for judging excellence, free of culturally-based perceptions of talent and promise.

A review of available information on the relative numbers and career histories of women and men in science reveals extensive discrimination. Access to the profession—graduate education, hiring, promotion, funding—is not always independent of gender. Unequal treatment of women in the laboratory, the lecture hall and the observatory, more subtle but at least as important as overt discrimination, creates a chilly climate which discourages and distresses women, alienates them from the field, and ultimately damages the profession.

Existing inequities can be eliminated only partially by legal stricture or they would not continue today. Improving the situation requires awareness of the very real barriers women currently face, including sexual stereotyping, opportunity and pay differentials, inappropriate time limits on advancement, over-critical scrutiny and sexual harassment. Sexual harassment, ranging from an uncomfortable work environment to unwanted sexual attention to overt extortion of sexual favors, can force confrontation between junior astronomers and older, better established colleagues who can strongly influence career advancement; it diverts attention from science to sex, places an undue burden on the harassed, and damages their self-esteem.

The entire profession must assume the immediate and ongoing responsibility for implementing strategies that will enable women to succeed within the existing structures of astronomy and allow the desired acceptance of diversity to develop fully.

Recommendations

1. Significant advances for women have been made possible by affirmative action. Affirmative action involves the establishment of serious goals, not rigid quotas, for achieving diversity in all aspects of the profession, including hiring, invited talks, committees, and awards.
 - a. Standards for candidates should be established and publicized in advance. Criteria that are culturally based or otherwise extraneous to performance or the pursuit of scientific excellence should not be applied.
 - b. Women should participate in the selection process. If insufficient numbers of women are available at particular institutions, outside scientists can be invited to assist. Men must share fully the

- responsibility for implementing affirmative action, as they hold the majority of leadership positions.
- c. The selection of women should reflect on average their numbers in the appropriate pool of candidates and normally at least one woman should be on the short list for any position, paid or honorific. When women are underrepresented in the pool, their numbers should be increased by active and energetic recruitment.
 - d. Demographic information for each astronomical organization should be widely publicized. If the goals for affirmative action are not achieved, the reasons must be determined.
2. The criteria used in hiring, assignment, promotion and awards should be broadened in recognition of different pacing of careers, care of older and younger family members, and demands of dual-career households. Provision for day care facilities, family leave, time off and re-entry will instantly improve women's access to an astronomical career and is of equal benefit to men.
 3. Strong action must be taken to end sexual harassment. Education and awareness programs are standard in U.S. government and industry and should be adopted by the astronomical community. Each institution should appoint one or more women to receive complaints about sexual harassment and to participate in the formal review process. Action against those who perpetrate sexual harassment should be swift and substantial.
 4. Gender-neutral language and illustrations are important in the formation of expectations, both by those in power and those seeking entrance to the profession. Documents and discussions should be sensitive to bias that favors any one gender, race, sexual orientation, life style, or work style. Those who represent astronomy to the public should be particularly aware of the power of language and images which, intentionally or unintentionally, reflect on astronomy as a profession.
 5. Physical safety is of concern to all astronomers and of particular significance to women, who often feel more vulnerable when working alone on campus or in observatories. This issue must be addressed by those in a position to affect security, making it possible for everyone to work at any hour, in any place, as necessary.

Call to Action

Improving the situation of women in astronomy will benefit, and is the responsibility of, astronomers at all levels. Department heads, observatory directors, policy committee chairs, and funding agency officials have a particular responsibility to facilitate the full participation of women: to nurture new talent, to ensure the effectiveness of teaching, and to examine and correct patterns of inequity. The profession should be responsible for regular review and assessment of the status of women in astronomy, in pursuit of equality and fairness for all.

A rational and collegial environment which allows full expression of intellectual style is necessary for achieving excellence in scientific research. Women should not have to be clones of male astronomers in order to participate in the mainstream of astronomical research. Women want and deserve the same opportunity as their male colleagues to achieve excellence in astronomy.

Signatories

Elise Albert, Ron Allen, Martha Anderson, Martina Belz Arndt, Neta Bahcall, Nancyjane Bailey, Suchitra Balachandran, Vicki Balzano, Stefi Baum, Barbara Becker, Lynne Billard, Karen S. Bjorkman, Cindy Blaha, Elizabeth Bonar, Peter Boyce, Susan W. Boynton, Mimi Bredeson, Margaret Burbidge, Claude Canizares, Nancy Chanover, Grace Chen, Jennifer Christensen, Frederick R. Chromey, Geoffrey C. Clayton, France A. Cordova, Anne Cowley, Laura Danly, Doris Daou, Doug Duncan, Joann Eisberg, Debra Elmegreen, Bruce Elmegreen, Michael Eracleous, Sheryl Falgout, Deborah C. Fort, Pru Foster, Diane L. Fowlkes, Linda French, Riccardo Giacconi, Diane Gilmore, Sherri D. Godlin, Daniel Golombek, Anne Gonnella, Shireen Gonzaga, Eva K. Grebel, Noreen Grice, Elizabeth Griffin, Heidi B. Hammel, Robert J. Hanisch, Helen M. Hart, Hashima Hasan, Isabel Hawkins, Tim Heckman, Charlene Heisler, Lori K. Herold, James E. Hesser, Susan Hoban, Jane Holmquist, Nancy Houk, Sethanne Howard, Svetlana Hubrig, Roberta Humphreys, Todd Hurt, Judith A. Irwin, Deepa R. Iyengar, Vera Izvekova, Helmut Jenkner, Inger Joergensen, Jennifer Johnson, Liana Johnson, Debora M. Katz-Stone, Laura Kay, Anne Kinney, Denise V. Kitson, Anuradha Koratkar, Ira Kostiuk, Susan Lamb, Adair Lane, Krista Lawrance, Robin Lerner, Janet Levine, Stephen Levine, Karen Lezon, Omar Lopez-Cruz, James Lowenthal, Olivia L. Lupie, Julie Lutz, Duccio Macchetto, Sue Madden, Bianca Mancinelli, Cathy Mansperger, Nathalie Martimbeau, Melissa McGrath, Jaylee Mead, Kathy Mead, Mike Meakes, Karen J. Meech, Windsor A. Morgan, Jr., Laretta M. Nagel, Susan Neff, Joy Nichols-Bohlin, Goetz Oertel, Sally Oey, Angela V. Olinto, Nancy Oliverson, Samantha Osmer, Nino Panagia, Pat Parker, Judith Perry, Joanna

Rankin, Luisa Rebull, Patty Reeves, Peter Reppert, Mercedes T. Richards, Carmelle Robert, Claudia A. Robinson, Elizabeth Roettger, Vera Rubin, Laura Ann Ruocco, Penny D. Sackett, Maitrayee Sahi, Londa Schiebinger, Regina E. Schulte-Ladbeck, Ethan Schreier, Andrea Schweitzer, Anouk A. Shambrook, Lea Shanley, Robin Shelton, Debra Shepherd, Lisa E. Sherbert, Angela Silverstein, Linda (Dix) Skidmore, Tatiana Smirnova, Ulysses J. Sofia, Emily Sterner, Sarah Stevens-Rayburn, Peter Stockman, Susan Stolovy, Alex Storrs, Svetlana Suleymanova, Cindy Taylor, Sheila Tobias, Eline Tolstoy, Andrea Tuffli, Meg Urry, Paul Vanden Bout, Fabienne van de Rydt, Liese van Zee, Frances Verter, Stefanie Wachter, William J. Wagner, Nolan R. Walborn, William H. Waller, Harold A. Weaver, Rachel Webster, Alycia Weinberger, Daryl Weinstein, Barbara Whitney, Reva K. Williams, Lance Wobus, Sidney Wolff, James P. Wright, Katharine C. Wright, Eric W. Wyckoff, Emily Xanthopoulos, Sophie Yancopoulos

APPENDIX D

PUBLISHED PAPER COUNTS

Published Papers Based on HST Data

STSci data available at <http://archive.stsci.edu/hst/bibliography/pubstat.html>.

▼ HST paper counts.

This table lists the number of papers in academic journals using Hubble Space Telescope data by year, and broken down according to whether the authors are General Observers who obtained HST observing time through the Time Allocation process, or whether they used HST data obtained from the archive. Some papers used data from both sources, and in others, the source isn't known.

Year	Total Papers	Part GO Part Archival	Archival	General Observers	Programs Not Assigned
1991	42	1	9	31	1
1992	58	4	18	34	2
1993	112	8	29	72	3
1994	178	14	39	122	3
1995	244	20	59	162	3
1996	307	35	84	177	11
1997	378	43	118	213	4
1998	509	41	164	278	26
1999	502	53	174	237	38
2000	537	66	183	247	41
2001	559	72	181	262	44
2002	602	99	202	241	60
2003	607	108	274	216	9
2004	611	98	248	238	27
2005	686	120	267	248	51

Year	Total Papers	Part GO Part Archival	Archival	General Observers	Programs Not Assigned
2006	715	114	295	227	79
2007	728	87	318	267	56
2008	704	81	324	236	63
2009	679	88	306	265	20
2010	734	107	356	259	12
2011	788	112	385	269	22
2012	847	135	361	309	42
2013	785	119	314	279	73
2014	818	142	357	301	18
2015	853	159	353	329	12
2016	883	160	370	333	20
2017	912	175	373	342	22
2018	968	172	397	368	31
2019	1,014	168	457	369	20

Published Papers by HST Instrument

Data is available at <http://archive.stsci.edu/hst/bibliography/pubstat.html>.

▼ HST paper counts by instrument.

This table lists academic papers in academic journals using Hubble Space Telescope data, broken down by instruments used for the observations.

Year	ACS	COS	FGS	FOC	FOS	GHRS	HSP	NICMOS	STIS	WFC3	WF/PC	WFPC2
1991	0	0	2	11	4	13	0	0	0	0	10	0
1992	0	0	3	14	9	9	0	0	0	0	22	0
1993	0	0	2	24	21	25	4	0	0	0	39	1
1994	0	0	3	29	38	39	4	0	0	0	53	15
1995	0	0	1	32	54	59	5	0	0	0	48	55
1996	0	0	2	23	58	45	4	0	0	0	30	147
1997	0	0	7	35	56	75	1	2	1	0	25	177
1998	0	0	5	15	83	88	2	25	20	0	18	258
1999	0	0	8	20	53	62	2	63	29	0	4	246
2000	0	0	7	2	35	47	1	89	83	0	7	279
2001	0	0	4	12	32	38	3	86	112	0	3	294
2002	1	0	6	10	37	25	0	64	160	0	5	319
2003	26	0	7	10	36	25	1	93	165	0	9	338
2004	122	0	9	12	29	26	2	60	175	0	5	306
2005	205	0	8	4	35	21	0	105	192	0	6	303
2006	297	0	4	12	28	28	1	116	163	0	8	274
2007	379	0	10	7	25	22	0	107	130	0	5	262
2008	405	0	5	5	14	10	0	111	98	0	6	260
2009	425	1	5	3	19	3	0	121	81	1	4	233
2010	410	18	4	7	20	18	1	117	95	48	8	245
2011	433	48	9	8	23	10	0	113	106	99	10	223
2012	452	44	3	3	14	15	0	93	113	186	3	231
2013	411	53	5	3	24	10	0	83	108	234	5	177
2014	417	69	7	3	20	11	1	67	108	311	4	181
2015	449	77	4	3	23	12	0	55	103	370	3	156
2016	457	83	3	6	25	11	0	70	114	374	1	141
2017	457	76	7	2	18	5	1	41	103	439	7	145
2018	440	93	8	4	16	13	0	47	131	501	3	156
2019	478	89	7	2	18	10	0	41	124	529	4	137

ACS Advanced Camera for Surveys (2002–present)

COS Cosmic Origins Spectrograph (2009–present)

FGS Fine Guidance Sensor (1990–present)

FOC Faint Object Camera (1990–2002)

FOS Faint Object Spectrograph (1990–1997)

GHRS Goddard High Resolution Spectrograph (1990–1997)

HSP High Speed Photometer (1990–1993)

NICMOS Near Infrared Camera & Multi-Imaging Spectrometer (1997–present)

STIS Space Telescope Imaging Spectrograph (1997–present)

WFC3 Wide Field Camera 3 (2009–present)

WF/PC Wide Field/Planetary Camera (1990–1993)

WFPC2 Wide Field Planetary Camera 2 (1993–2009)

ACRONYMS

▲ ACS image of NGC 346 in the small Magellanic cloud. (NASA, ESA, and A. Nota [STScI/ESA]: heic0502a)

AAS	American Astronomical Society	FGS	Fine Guidance Sensor
ACS	Advanced Camera for Surveys	FITS	Flexible Image Transport System
AO	Announcement of Opportunity	FOC	Faint Object Camera
ASP	Astronomical Society of the Pacific	FOS	Faint Object Spectrograph
AURA	Association of Universities for Research in Astronomy	FSS	Flight Support System
CADC	Canadian Astronomy Data Centre	FY	Fiscal Year
CAIB	Columbia Accident Investigation Board	GAO	Government Accountability Office
CANDELS	Cosmic Assembly Near-infrared Deep Extragalactic Legacy Survey	GO	General Observer
CCD	Charge-Coupled Device	GOODS	Great Observatories Origins Deep Survey
CD-ROM	Compact Disc-Read Only Memory	GSFC	Goddard Space Flight Center
CLASH	Cluster Lensing and Supernova Survey	GHRS	Goddard High Resolution Spectrograph
COBE	Cosmic Background Explorer	GTO	Guaranteed Time Observer
COSTAR	Corrective Optics Space Telescope Axial Replacement	HARP	Hubble Archive Re-Engineering Project
COS	Cosmic Origins Spectrograph	HDF	Hubble Deep Field
CSA	Canadian Space Agency	HIMS	Hubble Imaging Michelson Spectrometer
CSOC	Consolidated Space Operations Contract	HOST	HST Orbital Systems Test
DADS	Data Archive and Distribution Service	HSP	High Speed Photometer
DEC	Digital Equipment Corporation	HST	Hubble Space Telescope
DOC	Data Operations Control	ISS	International Space Station
DSS	Digitized Sky Survey	IUE	International Ultraviolet Observatory
EMU	Extravehicular Mobility Unit	JSC	Johnson Space Center
ESA	European Space Agency	JPL	Jet Propulsion Laboratory
ESAC	European Space Astronomy Centre	JWST	James Webb Space Telescope
EVA	Extra Vehicular Activity	KSC	Kennedy Space Center
		LST	Large Space Telescope

MAMA	Multi-Anode Microchannel Array	SCP	Supernova Cosmology Project
MAST	Mikulski Archive for Space Telescopes	SHOES	Supernovae H0 for the Equation of State
MDA	MacDonald Dettwiler and Associates, Ltd.	SOGS	Science Operations Ground System
MMU	Manned Maneuvering Unit	SOMO	Space Operations and Management Office
MSC	Marshall Space Center	STAC	Space Telescope Advisory Committee
MOSES	Mission Operations Software and Engineering Support	STAR	Space Telescope Axial Replacement
NAS	National Academy of Science	ST-ECF	Space Telescope-European Coordinating Facility
NASA	National Aeronautics and Space Administration	STIC	Space Telescope Institute Council
NGST	Next Generation Space Telescope (later JWST)	STIS	Space Telescope Imaging Spectrograph
NICMOS	Near Infrared Camera and Multi-Object Spectrometer	STOCC	Space Telescope Operations Control Center
NSF	National Science Foundation	STS	Space Transportation System
OAO	Orbiting Astronomical Observatory	STScI	Space Telescope Science Institute
OSS	Observation Support System	STUC	Space Telescope User Committee
OSS	NASA Office of Space Science	TAC	Time Allocation Committee
OTA	Optical Telescope Assembly	TDRS	Tracking and Data Relay Satellite
PHAT	Panchromatic Hubble Andromeda Treasury	TESS	Transiting Exoplanet Survey Satellite
POCC	Payload Operations Control Center	VEST	Vehicle Electrical System Test
PORTS	Preliminary Operations Requirements and Test Support	WETF	Weightless Environment Training Facility
PRESTO	Project to Re-Engineer Space Telescope Observing	WFC3	Wide Field Camera 3
PRS	PORTS Refurbishment System	WFIRST	Wide Field Infrared Survey Telescope (later Nancy Roman Space Telescope)
RFP	Request for Proposals	WF/PC	Wide Field Planetary Camera
SAO	Smithsonian Astrophysical Observatory	WFPC2	Wide Field Planetary Camera 2
		WMAP	Wilkinson Microwave Anisotropy Probe



BIBLIOGRAPHY

▲ 30th Anniversary Hubble image of the giant nebula NGC 2014 and its neighbor NGC 2020.
(NASA, ESA, and STScI)

REPORTS

- Allen, Lew, ed. *The Hubble Space Telescope Optical Systems Failure Report*. Washington, DC: NASA TM-103443, 1990.
- Astronomy and Astrophysics Survey Committee, Space Studies Board. *Astronomy and Astrophysics in the New Millennium*. Washington, DC: National Academy Press, 2001.
- Astronomy Survey Committee, *Astronomy and Astrophysics for the 1970s, Vol. 1*. Washington, DC: National Academy of Sciences, 1972.
- Astronomy Survey Committee, National Research Council. *Astronomy and Astrophysics for the 1980's, Volume I: Report of the Astronomy Survey Committee*, Washington, DC: National Academy of Sciences, 1982.
- Bahcall, John, et al. *Report of the HST-JWST Transition Panel*. Washington, DC: National Aeronautics and Space Administration, August 2003.
- Beckwith, Steven V. W. *The Hubble-JWST Transition: A Policy Synopsis*. Baltimore: STScI, 18 July 2003.
- Bely, Pierre-Yves, Christopher J. Burrows, and Garth D. Illingworth, eds. *The Next Generation Space Telescope: Proceedings of a Workshop Jointly Sponsored by the National Aeronautics and Space Administration and the Space Telescope Science Institute held at the Space Telescope Science Institute, Baltimore, Maryland, 13–15 September 1989*. Baltimore: STScI, 1989.
- Benvenuti, P. F. D. Macchetto, and E. J. Schreier, eds. *Science with the Hubble Space Telescope—II*. Baltimore: STScI, 1996.
- Bless, Robert. “Space Science: What’s Wrong at NASA.” In Francis T. Hoban, ed. *Issues in NASA Program and Project Management*. NASA SP 6101 (4). Washington, DC: National Aeronautics and Space Administration, 1991, pp. 35–43.

- Brandt, J. C., T. B. Ake III, and C. C. Petersen, eds. *The Scientific Impact of the Goddard High Resolution Spectrograph*. Astronomical Society of the Pacific Conference Series, vol. 143, 1998.
- Brown, Robert A., and Holland C. Ford, eds. *Report of the Hubble Space Telescope Strategy Panel: A Strategy for Recovery: Results of a Special Study August–October 1990*. Baltimore: Space Telescope Science Institute, 1991.
- Brown, Robert A. *The Future of Space Imaging: Report of a Community-Based Study of an Advanced Camera for the Hubble Space Telescope*. Baltimore: Space Telescope Science Institute, 1993.
- Christian, C. A., and Kinney, A. *The Public Impact of Hubble Space Telescope*. Space Telescope Science Institute, 1999.
- Columbia Accident Investigation Board Report, Volume 1*. Washington, DC: U.S. Government Printing Office, 2003.
- Committee on Astronomy and Astrophysics, National Research Council. *Federal Funding of Astronomical Research*. Washington, DC: National Academy Press, 2000.
- Committee on the Assessment of Options for Extending the Life of the Hubble Space Telescope. *Letter Report, July 13, 2004*. Washington, DC: National Academies Press, 2004.
- . *Assessment of Options for Extending the Life of the Hubble Space Telescope, Final Report*. Washington, DC: National Academies Press, 2005.
- Committee on International Space Programs, Space Studies Board. *U.S.-European Collaboration in Space Science*. Washington, DC: National Academy Press, 1998.
- Dressler, Alan, ed. *Exploration and the Search for Origins: A Vision for Ultraviolet-Optical-Infrared Space Astronomy: A Report of the 'HST and Beyond' Committee*. Washington, DC: Association of Universities for Research in Astronomy, 1996.
- Foster, Carleton, et al. *The Solar Array-Induced Disturbance of the Hubble Space Telescope Pointing System: NASA Technical Paper 3556*. Huntsville, AL: Marshall Space Flight Center, May 1995.
- Goddard Space Flight Center. *Hubble Space Telescope Robotic Servicing Mission: Mission Feasibility Study for the WFC3 and COS Scientific Instrument Installation*. Greenbelt: NASA Goddard Space Flight Center, 6 April 2004.
- Hall, Donald N. B. *The Space Telescope Observatory: Special Session of Commission 44, IAU, August 1982*. STScI, NASA Scientific and Technical Information Branch, 1982. NASA CP-2244.

- Hoban, Francis T., ed. *Issues in NASA Program and Project Management*. Washington, DC: NASA Scientific and Technical Information Program, 1991.
- Hubble Second Decade Committee. *The Hubble Data Archive: Toward the Ultimate Union Archive of Astronomy*. Baltimore: Space Telescope Science Institute, 2000.
- . *The Hubble Treasury Program: A New Class of Hubble Observations*. Baltimore: Space Telescope Science Institute, 2000.
- Hubble Space Telescope Post-SM4 Scientific Review Panel. *Final Report of the Hubble Space Telescope Post-SM4 Scientific Review Panel*. Washington, DC: National Aeronautics and Space Administration, 25 April 2003.
- Hubble European Space Agency Information Centre. *Hubble: 15 Years of Discovery*. Garching, Germany: European Space Agency, 2006.
- “Institutional Arrangements for the Space Telescope: Report of a Study at Woods Hole, Massachusetts, July 19–30, 1976.” Washington, DC: National Academies of Science, 1976.
- Kinney, Anne L., Diana Khachadourian, Pamela S. Millar, and Colleen N. Hartman, eds. *Meeting the Challenges of an Increasingly Diverse Workforce: Women in Astronomy and Space Science, Proceedings from the Conference Held at The Inn and Conference Center, University of Maryland, University College, October 21–23, 2009*. National Aeronautics and Space Administration, Goddard Space Flight Center, 2010.
- Livio, Mario S., Michael Fall, and Piero Madau, eds. *The Hubble Deep Field: Proceedings of the Space Telescope Science Institute Symposium Held in Baltimore, Maryland, May 6–9, 1997*. Cambridge and New York: Cambridge University Press, 1998.
- Macchetto, F. Duccio, ed. *The Impact of HST on European Astronomy, Astrophysics and Space Science Proceedings*. Chichester, UK: Springer-Praxis, 2010.
- Mattice, James J. *Hubble Space Telescope Systems Engineering Case Study*. Dayton, OH: Center for Systems Engineering, Air Force Institute of Technology, Wright-Patterson AFB, 2005.
- Moore, Duncan T., ed. *Final Report: Hubble Independent Optical Review Panel*. Greenbelt, MD: Goddard Space Flight Center P-442-0078, 1991.
- NASA Office of Inspector General. “Space Telescope Science Institute, Goddard Space Flight Center, 19 June 1989.” Document released to *www.governmentattic.org* on 25 March 2010 in response to requests made under the Freedom of Information Act and posted on 21 August 2009 on *www.governmentattic.org*.

- . “NASA OIG Report of Investigation: Hubble Space Telescope, Hughes Danbury Optical Systems Inc. (I-GO-90-259), January 8, 1991.” Document released to *www.governmentattic.org* on 24 March 2009 in response to requests made under the Freedom of Information Act and posted on 21 August 2009 on *www.governmentattic.org*.
- NASA. *The Role of the STScI in the HST Project: Prepared for the Subcommittee on Space Science and Applications of the Committee on Science and Technology of the U.S. House of Representatives*, undated but issued in 1986.
- . *2016 Hubble Space Telescope Senior Review*. Washington, DC: 8–10 March 2016.
- . *Hubble Space Telescope Disposal Study*. Washington, DC: November 2012.
- Newman, Ronald L. *STS-61 Mission Director’s Post-Mission Report: NASA Technical Memorandum 104803*. Houston: NASA Johnson Space Center Space Station Program Office, January 1995.
- Project RAND. *Preliminary Design of an Experimental World-Circling Spaceship*. Santa Monica, CA: Douglas Aircraft Company, Inc., 2 May 1946. Republished in 1996 by the RAND Corporation.
- Report of the Presidential Commission on the Space Shuttle Challenger Accident*. Washington, DC: June 1986.
- Return to Flight Task Group. *Final Report of the Return to Flight Task Group*. Washington, DC: National Aeronautics and Space Administration, July 2005.
- Rodney, George A. *Hubble Space Telescope: SRM&QA Observations and Lessons Learned*. Washington, DC: NASA Office of Safety and Mission Quality, 1990.
- Sembach, Kenneth R. *Hubble’s Science Legacy: Future Optical/Ultraviolet Astronomy from Space. Proceedings of a Workshop Held at University of Chicago, Chicago, Illinois, 2–5 April 2002*. San Francisco: Astronomical Society of the Pacific, 2003.
- Shea, Joseph F. *Report of the Task Force on the Hubble Space Telescope Servicing Mission*. Washington, DC: NASA, 21 May 1993.
- Space Science Board, The National Research Council. *Institutional Arrangements for the Space Telescope: Report of a Study at Woods Hole, Massachusetts, July 19–30, 1976*. Washington, DC: National Academy of Sciences, 1976.
- . *Space Science in the Twenty-First Century: Imperatives for the Decades 1995 to 2015, Astronomy and Astrophysics*, Washington, DC: National Academy Press, 1988.

- Space Telescope Science Institute Task Group, Space Science Board, National Research Council. *Institutional Arrangements for the Space Telescope: A Mid-Term Review*. Washington, DC: National Academy Press, 1985.
- Space Telescope Science Institute. *A Response to Report "The Role of the Space Telescope Science Institute in the Hubble Space Telescope Project" Prepared for the Space Telescope Institute Council*. 21 March 1986.
- Urry, C. Megan, Laura Danly, Lisa E. Sherbert, and Shireen Gonzaga, eds. *Women at Work: A Workshop on the Status of Women in Astronomy*. Baltimore: Space Telescope Science Institute, 1993.
- U.S. Congress, House of Representatives, Committee on Science, Space, and Technology. *Space Telescope Flaw: Hearing before the Committee on Science, Space, and Technology*. 101st Congress, 2nd session, 13 July 1990. Washington, DC: U.S. Government Printing Office, 1990.
- . *Review of the Hubble Space Telescope Mission: Hearing before the Committee on Science, Space, and Technology*. 103rd Congress, 2nd session, 8 March 1994. Washington, DC: U.S. Government Printing Office, 1994.
- U.S. Congress, Senate, Committee on Commerce, Science, and Transportation, Subcommittee on Science, Technology, and Space. *Status of the Hubble Space Telescope*. 101st Congress, 2nd session, 29 June 1990. Washington, DC: U.S. Government Printing Office, 1990.
- . *Hubble Space Telescope and the Space Shuttle Problems*. 101st Congress, 2nd session, 10 July 1990. Washington, DC: U.S. Government Printing Office, 1990.
- White, R. L., and R. J. Allen, eds. *The Restoration of HST Images and Spectra*. Baltimore: Space Telescope Science Institute, 1990.

BOOKS

- Adamcik, Robert A. *Voyages of Discovery: The Missions of the Space Shuttle Discovery*. Burlington, Ontario: Apogee Books, 2012.
- Anton, Ted. *Bold Science: Seven Scientists Who Are Changing Our World*. New York: W. H. Freeman and Company, 2000.
- Associated Press, The. *The Hubble Space Telescope: A Universe of New Discovery*. Miami: Mango Media, 2015.
- Baker, David. *NASA Hubble Space Telescope: Owner's Workshop Manual*. Sparkford, Yeovil, Somerset, UK: Haynes Publishing, 2015.
- . *US Spy Satellites, 1959 onwards (all missions, all models)*. Sparkford, UK: Haynes Publishing, 2016.
- Barbree, Jay, and Martin Caidin. *A Journey Through Time: Exploring the Universe with the Hubble Space Telescope*. New York: Penguin Books, 1995.

- Baumgarten, Dennis, ed. *Ball Aerospace: The First Forty Years*. Ball Aerospace and Technologies Corp., 1996.
- Benjamin, Marina. *Rocket Dreams: How the Space Age Shaped Our Vision of a World Beyond*. New York: Free Press, 2003.
- Billings, Lee. *Five Billion Years of Solitude: The Search for Life Among the Stars*. New York: Current, 2013.
- Bizony, Piers. *Island in the Sky: Building the International Space Station*. London: Aurum Press, 1996.
- Bonnet, Roger M., and Vittorio Manno. *International Cooperation in Space: The Example of the European Space Agency*. Cambridge: Harvard University Press, 1995.
- Bortz, Fred. *Beyond Jupiter: The Story of Planetary Astronomer Heidi Hammel*. Washington, DC: Joseph Henry Press, 2005.
- Brandt, John C., Thomas B. Ake III, and Carolyn Collins Peterson, eds. *The Scientific Impact of the Goddard High Resolution Spectrograph*. San Francisco: Astronomical Society of the Pacific Conference Series, vol. 143, 1998.
- Cabbage, Michael, and William Harwood. *Comm Check... The Final Flight of Shuttle Columbia*. New York: Free Press, 2004.
- Ceruzzi, Paul E. *A History of Modern Computing, Second Edition*. Cambridge, MA: The MIT Press, 2003.
- Chaisson, Eric J. *The Hubble Wars: Astrophysics Meets Astropolitics in the Two-Billion-Dollar Struggle over the Hubble Space Telescope*. New York: HarperCollins, 1994.
- Christianson, Gale E. *Edwin Hubble: Mariner of the Nebulae*. New York: Farrar, Strauss and Giroux, 1995.
- Christenson, L. L., and R. Fosbury. *Hubble: 15 Years of Discovery*. New York: Springer Science, 2006.
- Clark, Stuart. *Universe in Focus: The Story of the Hubble Telescope*. Abingdon, UK: Andromeda Oxford, 1997.
- Clary, David A. *Rocket Man: Robert H. Goddard and the Birth of the Space Age*. New York: Hyperion, 2003.
- Clinton, Bill. *My Life*. New York: Alfred A. Knopf, 2004.
- Collins, Martin. *Cold War Laboratory: RAND, the Air Force, and the American State, 1945–1950*. Washington, DC: Smithsonian Institution Press, 2002.
- Damohn, Mark. *Back Down to Earth: The Development of Space Policy for NASA During the Jimmy Carter Administration*. San Jose: Authors Choice Press, 2001.
- David, James E. *Spies and Shuttles: NASA's Secret Relationships with the DoD and CIA*. Gainesville, FL: University Press of Florida, 2015.

- Davies, John K. *Satellite Astronomy: The Principles and Practice of Astronomy from Space*. Chichester: Ellis Horwood Ltd., 1988.
- DeVorkin, David H. *Science With A Vengeance: How the Military Created the US Space Sciences After World War II*. New York: Springer-Verlag, 1992.
- DeVorkin, David H., ed. *Beyond Earth: Mapping the Universe*. Washington, DC: National Geographic Society, 2002.
- DeVorkin, David, and Robert W. Smith, *The Hubble Space Telescope: Imaging the Universe*. Washington, DC: National Geographic Society, 2004.
- . *Hubble: Imaging Space and Time*. Washington, DC: National Geographic Society, 2011.
- . *The Hubble Cosmos: 25 Years of New Vistas in Space*. Washington, DC: National Geographic Society, 2015.
- Dick, Steven J., and James E. Strick. *The Living Universe: NASA and the Development of Astrobiology*. New Brunswick, NJ: Rutgers University Press, 2005.
- Dickinson, Terence. *Hubble's Universe: Greatest Discoveries and Latest Images*. Toronto: Firefly Books, 2012.
- Dyson, Freeman. *From Eros to Gaia*. New York: Pantheon Books, 1992.
- Edmondson, Frank K. *AURA and Its US National Observatories*. Cambridge: Cambridge University Press, 1997.
- European Space Agency. *A Long Look Back: ESA's Faint Object Camera*. Paris: ESA, 1990 (ESA BR-67).
- Expanding Universe: Photographs from the Hubble Space Telescope*. Contributions from Owen Edwards, Charles F. Bolden, Zoltan Levay, and John M. Grunsfeld. Cologne: Taschen GmbH, 2015.
- Finkbeiner, Ann K. *A Grand and Bold Thing: An Extraordinary Map of the Universe Ushering In a New Era of Discovery*. New York: Free Press, 2010.
- Fischer, Daniel, and Hilmar Duerbeck. *Hubble: A New Window on the Universe*. New York: Springer-Verlag, 1996.
- . *Hubble Revisited: New Images From the Discovery Machine*. New York: Springer-Verlag, 1998.
- Florence, Ronald. *The Perfect Machine: Building the Palomar Telescope*. New York: HarperCollins, 1994.
- Giacconi, Riccardo. *Secrets of the Hoary Deep: A Personal History of Modern Astronomy*. Baltimore: Johns Hopkins University Press, 2008.
- Goodstein, David L. *Adventures in Cosmology*. Singapore: World Scientific Publishing Co. Ptc. Ltd., 2011.
- Goodwin, Simon. *Hubble's Universe: A Portrait of Our Cosmos*. New York: Penguin Books, 1996.

- Goodwin, Simon, and John Gribbin. *Deep Space: New Pictures From the Hubble Space Telescope*. London: Constable and Company Limited, 1999.
- Hanlon, Michael. *The Worlds of Galileo: The Inside Story of NASA's Mission to Jupiter*. New York: St. Martin's Press, 2001.
- Harwit, Martin. *Cosmic Discovery: The Search, Scope and Heritage of Astronomy*. New York: Basic Books Inc., 1981.
- . *In Search of the True Universe: The Tools, Shaping, and Cost of Cosmological Thought*. Cambridge: Cambridge University Press, 2013.
- Heck, Andre, ed. *Information Handling in Astronomy—Historical Vistas*. Dordrecht: Kluwer Academic Publishers, 2011.
- Heilbron, J. L. *Galileo*. Oxford: Oxford University Press, 2010.
- Hitt, David, and Heather R. Smith. *Bold They Rise: The Space Shuttle Early Years, 1972–1986*. Lincoln: University of Nebraska Press, 2014.
- Hoskin, Michael, ed. *The Cambridge Concise History of Astronomy*. Cambridge: Cambridge University Press, 1999.
- Houston, Rick. *Wheels Stop: The Tragedies and Triumphs of the Space Shuttle Program, 1986–2011*. Lincoln: University of Nebraska Press, 2013.
- Impey, Chris, and Holly Henry. *Dreams of Other Worlds: The Amazing Story of Unmanned Space Exploration*. Princeton, NJ: Princeton University Press, 2013.
- Jenkins, Dennis R. *Space Shuttle: Developing an Icon*, 3 vols. Forest Lake, MN: Specialty Press, 2016.
- Jenkins, Dennis R., and Jorge R. Frank. *Servicing the Hubble Space Telescope: Space Shuttle Atlantis—2009*. North Branch, MN: Specialty Press, 2009.
- Kanipe, Jeff. *Chasing Hubble's Shadows: The Search for Galaxies at the Edge of Time*. New York: Hill and Wang, 2006.
- Kelly, Scott, and Margaret Lazarus Dean. *Endurance: A Year in Space, A Lifetime of Discovery*. New York: Alfred A. Knopf, 2017.
- Kerrod, Robin, and Carole Stott. *Hubble: The Mirror on the Universe, Third Edition*. Toronto: Firefly Books, 2011.
- Kessler, Elizabeth A. *Picturing the Cosmos: Hubble Space Telescope Images and the Astronomical Sublime*. Minneapolis: University of Minnesota Press, 2012.
- Kirshner, Robert P. *The Extravagant Universe: Exploding Stars, Dark Energy and the Accelerating Cosmos*. Princeton: Princeton University Press, 2002.
- Kondo, Yoji, and W. Wamsteker, eds. *Exploring the Universe with the IUE Satellite*. Dordrecht: Kluwer Academic Publishers, 1987.
- Krige, J., A. Russo, and L. Sebesta. *A History of the European Space Agency, 1958–1987, Vol. 1, The Story of ESA, 197–1987*, Nordwijk: European Space Agency SP-1235, April 2000.

- Krige, John, Angelina Long Callahan, and Ashok Maharaj. *NASA in the World: Fifty Years of International Collaboration in Space*. New York: Palgrave Macmillan, 2013.
- Krige, John, and Dominique Pestre, eds. *Science in the Twentieth Century*. London: Routledge, 2014.
- Kuhn, Thomas. *Structure of Scientific Revolutions*. Chicago: University of Chicago Press, 1970.
- Launius, Roger D., and Howard E. McCurdy. *Robots in Space: Technology, Evolution and Interplanetary Travel*. Baltimore: The Johns Hopkins University Press, 2008.
- Launius, Roger D., and David H. DeVorkin, eds. *Hubble's Legacy: Reflections by Those Who Dreamed It, Built It, and Observed the Universe With It*. Washington, DC: Smithsonian Institution Scholarly Press, 2014.
- Leckrone, David S. *Life With Hubble: An Insider's View of the World's Most Famous Telescope*. London: IOP Publishing, 2020.
- Lenehan, Anne E. *Story: The Way of Water*. Hornsby Westfield NSW, Australia: The Communications Agency, 2014.
- Leverington, David. *New Cosmic Horizons: Space Astronomy from the V2 to Hubble Space Telescope*. Cambridge: Cambridge University Press, 2000.
- Levy, David H. *Impact Jupiter: The Crash of Comet Shoemaker-Levy 9*. Cambridge, MA: Basic Books, 1995.
- . *A Nightwatchman's Journey: The Road Not Taken*. Toronto: The Royal Astronomical Society of Canada, 2019.
- Livio, M., S.M. Fall, and P. Madeu, eds. *The Hubble Deep Field*. New York: Cambridge University Press, 1998.
- Livio, Mario S., Keith Noll, Massimo Stiavelli, and Michael Fall, eds. *A Decade of Hubble Space Telescope Science*. New York: Cambridge University Press, 2003.
- Longair, Malcolm. *Alice and the Space Telescope*. Baltimore, MD: Johns Hopkins University Press, 1989.
- MacDonald, Alexander. *The Long Space Age: The Economic Origins of Space Exploration from Colonial America to the Cold War*. New Haven: Yale University Press, 2017.
- Massimino, Mike. *Spaceman: An Astronaut's Unlikely Journey to Unlock the Secrets of the Universe*. New York: Crown Archetype, 2016.
- McCray, W. Patrick. *Giant Telescopes: Astronomical Ambition and the Promise of Technology*. Cambridge, MA: Harvard University Press, 2004.
- McCurdy, Howard E. *Space and the American Imagination*. Washington, DC: Smithsonian Institution Press, 1997.

- . *Faster Better Cheaper: Low-Cost Innovation in the U.S. Space Program*. Baltimore: The Johns Hopkins University Press, 2001.
- McDonald, Allan J., and James R. Hansen. *Truth, Lies and O-Rings: Inside the Space Shuttle Challenger Disaster*. Gainesville: University Press of Florida, 2009.
- McDougall, Walter A. ...*The Heavens and The Earth: A Political History of the Space Age*. New York: Basic Books Inc., 1985.
- Meacham, John. *Destiny and Power: The American Odyssey of George Herbert Walker Bush*. New York: Random House, 2015.
- Messeri, Lisa. *Placing Outer Space: An Earthly Ethnography of Other Worlds*. Durham, NC: Duke University Press, 2016.
- Neal, Valerie. *Spaceflight in the Shuttle Era and Beyond: Redefining Humanity's Purpose in Space*. New Haven: Yale University Press, 2017.
- Neff, Todd. *From Jars to the Stars: How Ball Came to Build a Comet-Hunting Machine*. Denver: Earthview Media, 2010.
- Neufeld, Michael J. *The Rocket and the Reich: Peenemünde and the Coming of the Ballistic Missile Era*. Cambridge: Harvard University Press, 1995.
- Nussbaumer, Harry, and Lydia Bieri. *Discovering the Expanding Universe*. New York: Cambridge University Press, 2009.
- Oberth, Hermann. *The Rocket Into Planetary Space*. English edition, Berlin: De Gruyter Oldenbourg, 2014.
- Overbye, Dennis. *Lonely Hearts of the Cosmos: The Scientific Quest for the Secrets of the Universe*. New York: HarperCollins, 1991.
- Panek, Richard. *Seeing and Believing: How the Telescope Opened Our Eyes and Minds to the Heavens*. New York: Viking, 1998.
- . *The 4% Universe: Dark Matter, Dark Energy and the Race to Discover the Rest of Reality*. Boston: Houghton Mifflin Harcourt, 2011.
- Pellerin, Charles J. *How NASA Builds Teams: Mission Critical Soft Skills for Scientists, Engineers, and Project Teams*. Hoboken, NJ: John Wiley and Sons, Inc., 2009.
- Peterson, Carol Collins, and John C. Brandt. *Hubble Vision: Astronomy with the Hubble Space Telescope*. Cambridge, UK: Cambridge University Press, 1995.
- . *Hubble Vision: Further Adventures with the Hubble Space Telescope*. Cambridge, UK: Cambridge University Press, 1998.
- . *Visions of the Cosmos*. Cambridge, UK: Cambridge University Press, 2003.
- Powell, Joel W., and Lee Robert Caldwell. *Space Shuttle Almanac: A Comprehensive Overview of the First 20 Years of Space Shuttle Operations*. Calgary: Microgravity Press, 2012.

- Preston, Richard. *First Light: The Search for the Edge of the Universe*. New York: Random House, 1996.
- Rector, Travis A., Kimberley Kowal Arcand, and Megan Watzke. *Coloring the Universe: An Insider's Look at Making Spectacular Images of Space*. Fairbanks: University of Alaska Press, 2015.
- Rieke, George H. *The Last of the Great Observatories*. Tucson: University of Arizona Press, 2006.
- Schaller, Michael. *Right Turn: American Life in the Reagan-Bush Era 1980–1992*. New York: Oxford University Press, 2007.
- Shayler, David J., and David M. Harland. *The Hubble Space Telescope: From Concept to Success*. New York: Springer-Praxis Books, 2015.
- . *Enhancing Hubble's Vision: Service Missions That Expanded Our View of the Universe*. New York: Springer-Praxis Books, 2015.
- Sietzen, Frank, and Keith L. Cowing. *New Moon Rising: The Making of America's New Space Vision and the Remaking of NASA*. Burlington, ON: Apogee Books, 2004.
- Smith, Robert W. *The Space Telescope: A Study of NASA, Science, Technology and Politics*. Cambridge: Cambridge University Press, 1993.
- . *The Expanding Universe: Astronomy's "Great Debate," 1900–1931*. New York: Cambridge University Press, 1982.
- Sobel, Dava. *The Glass Universe: How the Ladies of the Harvard Observatory Took the Measure of the Stars*. New York: Penguin Books, 2017.
- Soluri, Michael Robert. *Infinite Worlds: The People and Places of Space Exploration*. New York: Simon & Schuster, 2014.
- Spencer, John R., and Jacqueline Mitton, eds. *The Great Comet Crash: The Collision of Comet Shoemaker-Levy 9 and Jupiter*. Cambridge: Cambridge University Press, 1995.
- Sullivan, Kathryn D. *Handprints on Hubble: An Astronaut's Story of Invention*. Cambridge, MA: The MIT Press, 2019.
- Tasker, Elizabeth. *The Planet Factory: Exoplanets and the Search for a Second Earth*. London: Bloomsbury Sigma, 2019.
- Tucker, Wallace, and Karen Tucker. *Revealing the Universe: The Making of the Chandra X-Ray Observatory*. Cambridge, MA: Harvard University Press, 2001.
- Vaughn, Diane. *The Challenger Launch Decision: Risky Technology, Culture, and Deviance at NASA*. Chicago: University of Chicago Press, 1996.
- Weiler, Edward J. *Hubble: A Journey Through Space and Time*. New York: Abrams, 2010.
- Westwick, Peter J. *Into the Black: JPL and the American Space Program 1976–2004*. New Haven: Yale University Press, 2007.

- Whitfield, Steven. *Hubble Space Telescope*. Burlington, ON: Apogee Books, 2006.
- Wilford, John Noble, ed. *Cosmic Dispatches: The New York Times Reports on Astronomy and Cosmology*. New York: W. W. Norton and Co., 2001.
- Wilson, Andrew. *ESA Achievements: More Than 30 Years of Pioneering Space Activity, 3rd Edition*. Noordwijk: European Space Agency, 2005.
- Woodward, Bob. *The Agenda: Inside the Clinton White House*. New York: Simon & Schuster, 1994.
- Zimmerman, Robert. *The Universe in a Mirror: The Saga of the Hubble Space Telescope and the Visionaries Who Built It*. Princeton, NJ: The Princeton University Press, 2008.

NASA HISTORIES

- Alexander, Joseph K. *Science Advice to NASA: Conflict, Consensus, Partnership, Leadership*. Washington, DC: NASA Monographs in Aerospace History, no. 57, 2017.
- Asner, Glen R., and Stephen J. Garber. *Origins of 21st-Century Space Travel: A History of NASA's Decadal Planning Team and the Vision for Space Exploration, 1999–2004*. Washington, DC: National Aeronautics and Space Administration, 2019. NASA SP-2019-4415.
- Dunar, Andrew J., and Stephen P. Waring. *Power to Explore: A History of Marshall Space Flight Center 1960–1990*. Washington, DC: National Aeronautics and Space Administration, 1999.
- Erickson, Edwin F., and Allan W. Meyer. *NASA's Kuiper Airborne Observatory, 1971–1995: An Operations Retrospective With a View to SOFIA*. Moffett Field, CA: NASA Ames Research Center, 2013.
- Heppenheimer, T. A. *The Space Shuttle Decision: NASA's Search for a Reusable Space Vehicle*. Washington, DC: NASA History Office, 1999.
- . *The Development of the Space Shuttle 1972/1981*. Washington, DC: Smithsonian Institution Press, 2002.
- Hogan, Thor. *Mars Wars: The Rise and Fall of the Space Exploration Initiative*. Washington, DC: National Aeronautics and Space Administration, August 2007.
- Logsdon, John M., general editor, Amy Paige Snyder, Roger D. Launius, Stephen J. Garber, and Regan Anne Newport. *Exploring the Unknown: Selected Documents in the History of the U.S. Civil Space Program, Volume V, Exploring the Cosmos*. NASA SP-2001-4407, 2001.
- McRoberts, Joseph J. *Space Telescope*. Washington, DC: National Aeronautics and Space Administration, 1982.

- Portree, David S. F., and Robert C. Trevino. *Walking to Olympus: An EVA Chronology*. Washington, DC: NASA History Office, Monographs in Aerospace History No. 7, October 1997.
- Rottner, Renee M. *Making the Invisible Visible: A History of the Spitzer Infrared Telescope Facility (1971–2003)*. Washington, DC: NASA Monographs in Aerospace History, No. 47, 2017.
- Tatarewicz, Joseph N. “The Hubble Space Telescope Servicing Mission.” In Pamela E. Mack, ed. *From Engineering Science to Big Science: The NACA and NASA Collier Trophy Research Project Winners*. Washington, DC: NASA History Office, 1998.
- Tsiao, Sunny. “Read You Loud and Clear!” *The Story of NASA’s Spaceflight Tracking and Data Network*. Washington, DC: National Aeronautics and Space Administration, 2008. NASA SP-2007-4232.
- Wallace, Lane E. *Dreams, Hopes, Realities: NASA’s Goddard Space Flight Center: The First Forty Years*. Washington, DC: National Aeronautics and Space Administration, 1999. NASA SP-4312.

JOURNALS, PERIODICALS, AND MANUSCRIPTS

- Abt, Helmut A. “Is the Astronomical Literature Still Expanding Exponentially?” *Publications of the Astronomical Society of the Pacific*, vol. 110, no. 744 (February 1998): 210–213.
- Abt, Helmut A., and Sarah Stevens-Rayburn. “Publication Statistics for Recent Papers from the Hubble Space Telescope.” *Bulletin of the American Astronomical Society*, 34 (2001): 935–937.
- Bahcall, John N., Puragra Guhathakurta, and Donald P. Schneider. “What the Longest Exposures from the Hubble Space Telescope Will Reveal.” *Science*, vol. 248 (13 April 1990): 178–183.
- Bahcall, Neta A. “The Hubble Space Telescope.” *Annals of the New York Academy of Sciences*, 470 (1986): 331–337.
- Beckwith, Steven V. W., et al. “The Hubble Ultra Deep Field,” *The Astronomical Journal*, 132: 1729–1755, 2006
- Bogges, Albert, and David S. Leckrone. “The History and Promise of the Hubble Space Telescope,” *Optics and Photonics News*, 1(3) (March 1990): 9–16.
- Brasch, Klaus. “A Short History of Astrophotography: Part 1.” *Journal of the Royal Astronomical Society of Canada*, vol. 111, no. 2 (April 2017): 52–59.
- Capers, Robert, and Eric Lipton. “Hubble Error: Time, Money, and Millionths of an Inch.” *Hartford Courant* (31 March 1991–3 April 1991).

- Cepollina, Frank J., and James Mansfield. "In-Orbit Servicing," *Aeronautics & Aeronautics* (AIAA: February 1975): 48-56.
- Chaisson, E.C. "Early Results from the Hubble Space Telescope," *Scientific American*, 226(6) (June 1992): 44–51.
- Chaisson, E. C., and R. Villard. "The Science Mission of the Hubble Space Telescope." *Vistas in Astronomy*, 33(2) (1990): 105–141.
- Cole, Stephen. "Astronomy on the Edge: Using the Hubble Space Telescope." *Sky & Telescope* (October 1992): 386-394.
- Cowen, Ron. "Space Telescope: A Saga of Setbacks." *Science News* (6 January 1990): 8+. *Business Insights: Essentials*. Web page (accessed 20 August 2015).
- Crocker, James H. "Engineering the COSTAR." *Optics and Photonics News*, vol. 4 no. 11 (November 1993): 22–26.
- Dalcanton, J. J. "18 Years of Science with the Hubble Space Telescope." *Nature*, 457, 41–50.
- Ferrarese, Laura. "Measuring the Expansion Rate of the Universe." In *Adventures in Cosmology*, edited by David L. Goodstein. Singapore: World Scientific Publishing Co. Ptc. Ltd., (2011).
- Field, George B. "Lyman Spitzer, Jr. (1914–1997)." *Publications of the Astronomical Society of the Pacific*, vol. 110, no. 745 (March 1998): 215–222.
- Foster, Carlton, et al. *The Solar Array-Induced Disturbance of the Hubble Space Telescope Pointing System: NASA Technical Paper 3556*. Huntsville, AL: Marshall Space Flight Center, May 1995.
- . "Solar-Array-Induced Disturbance of the Hubble Space Telescope Pointing System." *Journal of Spacecraft and Rockets*, vol 32, no. 4 (July–August 1995): 634–644.
- Freedman, Wendy L., et al. "Final Results from the Hubble Space Telescope Key Project to Measure the Hubble Constant." *The Astrophysical Journal*, vol. 553 (20 May 2001): 47–72.
- Gainor, Christopher. "The Hubble Space Telescope and Astrophotography." *The Journal of the Royal Astronomical Society of Canada*, vol. 104, no. 5 (October 2010): 199–200.
- . "The Hubble Space Telescope in Cyberspace." *Quest: The History of Spaceflight Quarterly*, vol. 24, no. 2, (2017): 4–12.
- . "Hubble Space Telescope and the Shuttle: Advancing Satellite Servicing." *Spaceflight* (July 2017): 262–268.
- Griffiths, R. E., et al. "The Hubble Space Telescope Medium Deep Survey with the Wide Field and Planetary Camera. 1. Methodology and Results on

- the Field Near 3c 273." *The Astrophysical Journal*, vol. 437 (10 December 1994): 67–82.
- Hawley, Steven A. "How Launching Hubble Space Telescope Influenced Space Shuttle Mission Operations." *Journal of Spacecraft and Rockets*, vol. 51, no. 2 (2014): 385–396.
- . "Hubble Space Telescope Solar Array Concerns and Consequences for Servicing Mission 2." *Journal of Spacecraft and Rockets*, online November 2015.
- Henson, B. W. "ESA's First In-Orbit-Replaceable Solar Array." *ESA Bulletin*, no. 61 (February 1990): 13–19.
- Hoeppe, Götz. "Astronomers at the Observatory: Place, Visual Practice, Traces." *Anthropological Quarterly* 85 (4) (2012): 1141–1160.
- . "Working Data Together: The Accountability and Reflexivity of Digital Astronomical Practice." *Social Studies of Science* 44 (2) (2014): 243–270.
- Hughes, Thomas P. "The Evolution of Large Technological Systems," in *The Social Construction of Technological Systems*, edited by Wiebe Bijker, Thomas P. Hughes, and Trevor Pinch, 51–82. Cambridge: MIT Press, 1989.
- Jeletic, Jim. "Long Live Hubble." *Air & Space Smithsonian*, vol. 33, no. 6 (December 2018/January 2019): 18, 20.
- Kahan, Mark A. "Optical Testing and Verification on HST." In *Optics and Photonics News*, vol. 4 no. 11 (November 1993): 28–34.
- Kessler, Elizabeth. "The Hubble's Anniversary." *Quest: The History of Spaceflight Quarterly*, vol. 17, no. 2 (2010): 34–43.
- Kondo, Yoji, et al. "Astrophysical Contributions of the International Ultraviolet Explorer." *Annual Review of Astronomy and Astrophysics*, 1989, vol. 27, 397–420.
- Kragh, Helge. *Conceptions of Cosmos from Myths to the Accelerating Universe: A History of Cosmology*. New York: Oxford University Press, 2006.
- Kragh, Helge, and Robert W. Smith. "Who Discovered the Expanding Universe?" *History of Science*, vol. 41, no. 2 (2003): 141–162.
- Lambright, W. Henry. "Leadership and Change at NASA: Sean O'Keefe as Administrator." *Public Administration Review* (March–April 2008): 230–240.
- Lattis, James M. *A Hubble Instrument Comes Home: UW Madison's High Speed Photometer*. 2012, <https://spacegrant.carthage.edu/ojs/index.php/wsc/article/download/27/27/1/PB.pdf>.
- Lasker, Barry M., et al. "The Second-Generation Guide Star Catalog: Description and Properties." *The Astronomical Journal*, vol. 136 (August 2008): 735–766.

- Laurance, R. J. "The History of the Hubble Space Telescope and ESA's Involvement." *ESA Bulletin*, no. 61 (February 1990): 9–11.
- Leckrone, David S. "The Space Telescope Science Instruments." *Publications of the Astronomical Society of the Pacific*, vol. 92, no. 545 (February 1980): 5–21.
- Livio, Mario. "Hubble's Legacy," *Nature* (15 April 2015): 287–289.
- Lindley, David. "Space Telescope Ready at Last," *Nature*, vol. 339 (16 March 1990): 199.
- Malumuth, Eliot M., and Sara R. Heap. "UBV Stellar Photometry of the 30 Doradus Region of the Large Magellanic Cloud with the Hubble Space Telescope." *The Astronomical Journal*, vol. 107, no. 3 (March 1994): 1054–1066.
- Marcum, James A. "The Revolutionary Ideas of Thomas Kuhn." *Times Literary Supplement* (17 January 2018).
- McCray, W. Patrick. "How Astronomers Digitized the Sky." *Technology and Culture* 55, no. 4 (October 2014): 908–44.
- . "The Biggest Data of All: Making and Sharing a Digital Universe." In *Data Histories: Osiris 32*, edited by Elena Aronova, Christine von Oertzen, and David Sepkoski, 243–263, 2017.
- Mende, S. B., et al. "Space Vehicle Glow Measurements on STS 41-D." *Journal of Spacecraft and Rockets*, vol. 23, no. 3 (March–April 1986): 189–193.
- Miller, Glenn E., and Mark D. Johnston. "A Case Study of Hubble Space Telescope Proposal Processing, Planning and Long-Range Scheduling." 8th Computing in Aerospace Conference, Computers in Aerospace Conference, American Institute of Aeronautics and Astronautics, 1991.
- Mountain, Matt. "Flattening the Astronomy World." *Physics Today* (February 2014): 8–9.
- Nota, Antonella, Mark McCaughrean, Bob Fosbury, Colleen Sharkey, and Carl Walker. "Seeing with Hubble Vision," *ESA Bulletin*, no. 142 (May 2010): 3–11.
- O'Meara, Stephen James. "The Demise of the HST Amateur Program." *Sky & Telescope* (June 1997): 97–104.
- Perlmutter, Saul S., et al. "Measurements of Omega and Lambda from 42 High Redshift Supernovae." *Astrophysical Journal*, vol. 517, no. 6 (1999): 565–586.
- Posey, Daniel. "'Gateway to the Stars': Science, Civic Identity, and Tourism at the Dominion Astrophysical Observatory, Victoria B.C. 1903–1941." Master's Thesis, University of Victoria, 2013.

- Pressel, Phil. "The Hexagon KH-9 Spy Satellite," *Quest: The History of Spaceflight Quarterly*, vol. 24, no. 3 (2017): 13–23.
- Rector, Travis A., Zoltan G. Levay, Lisa M. Frattare, Jayanne English, and Kirk Pu'uhou-Pummill. "Image Processing Techniques for the Creation of Presentation- Quality Astronomical Images." *The Astronomical Journal*, 133(2): 598–611.
- Reid, Neill. "The Evolution of the Hubble TAC Process." *STScI Newsletter*, vol. 30, no. 1 (2013): 6-11.
- Riess, Adam G., et. al. "Observational Evidence from Supernovae for an Accelerating Universe and a Cosmological Constant." *The Astronomical Journal*, vol. 116, no. 3 (September 1998): 1009–1038.
- Riess, et al. "A 2.4% Determinant of the Local Value of the Hubble Constant." *The Astrophysical Journal*, vol. 286, no. 1 (21 July 2016).
- Ross-Nazzal, Jennifer. "An Interview with Kathryn D. Sullivan." *Quest: The History of Spaceflight Quarterly*, vol. 17, no. 2 (2010): 18–33.
- Rothenberg, Joseph. "Hubble Space Telescope: Restoring the Image." *Optics and Photonics News*, vol. 4 no. 11 (November 1993): 10–16.
- Smith, Robert W. "The Biggest Kind of Big Science: Astronomers and the Space Telescope." In *Big Science: The Growth of Large-Scale Research*, edited by Peter Galison and Bruce Hevly. Stanford: Stanford University Press, 1992, 184–211.
- Smith, Robert W., and Joseph N. Tatarewicz. "Replacing a Technology: The Large Space Telescope and CCDs." *Proceedings of the IEEE 73/7 (7/1985)*: 1221–1237.
- . "Counting on Invention: Devices and Black Boxes in Very Big Science." *Osiris*, vol. 9 (1994): 101–123.
- . "HST in Orbit: Ten Years and Counting," *Sky & Telescope* (April 2000): 28–34.
- . "The Making of Space Astronomy: A Gift of the Cold War." In *Earth-Bound to Satellite: Telescopes, Skills and Networks*, edited by A.D. Morrison-Low, Sven Dupre, Stephen Johnston, and Georgio Strano. Leiden: Brill, 2011, 235–249.
- . "Hubble's Law." In *Discoveries in Modern Science: Exploration, Invention, Technology*, edited by James Trefil. Farmington Hills, MI.: Macmillan Reference USA, 2014, 511–522.
- "Space Telescope European Coordinating Facility." *ESA Bulletin*, no. 142 (May 2010): 4–5.
- Spitzer, Lyman Jr. "History of the Space Telescope." *Quarterly Journal of the Royal Astronomical Society* 20 (1979): 29–36.

- Timothy, Gethyn. "Review of Multianode Microchannel Array Detector Systems." *Journal of Astronomical Telescopes, Instruments, and Systems* 2(3), 030901 (July–September 2016).
- Trauger, John. "Wide Field and Planetary Camera 2: The Camera that Saved Hubble," undated memoir.
- Tremaine, Scott D. *John Norris Bahcall 1934–2005, A Biographical Memoir*. Washington, DC: National Academy of Sciences, 2011.
- Tucker, Wallace. "The Space Telescope Science Institute." *Sky & Telescope*, (April 1985): 295–299.
- Vaughn, Arthur H., and David H. Rogers. "Development of the Second Generation Wide Field Planetary Camera for HST." *Optics and Photonics News*, vol. 4, no. 11 (November 1993): 17–21.
- Villard, Ray, and Zoltan Levay. "Creating Hubble's Technicolor Universe," *Sky & Telescope* (September 2002): 28–34.
- Wenz, John. "How Stargazing Became a Numbers Game." *The Atlantic* (21 May 2015).
- Williams, Robert E., et al. "The Hubble Deep Field: Observations, Data Reduction, and Galaxy Photometry." *Astronomical Journal*, vol. 112 (October 1996): 1335.
- Wood, H. John. Notebooks on his work with HST at NASA Goddard, 1990–1994.
- . "Some Personal Recollections About the Recovery of the Hubble Space Telescope Optical Performance 1990–1993," undated manuscript.
- Zimmerman, Robert. "Mr. Fix It: Frank Cepollina Takes Repair Calls to New Heights." *Air & Space Smithsonian* (May 2010).
- Zwicky, F. "Research with Rockets," *Publications of the Astronomical Society of the Pacific*, vol. 59, no. 347 (April 1947): 64–73.

VIDEOS

- Christensen, Lars Lindberg, executive producer/director. *Hubble: 15 Years of Discovery*, European Space Agency. DVD, 2005.
- Gaynes, David, director. *Saving Hubble*. American Ideal Pictures, 2013.
- Ferguson, Graeme, producer/writer. *Destiny in Space*. IMAX Experience. IMAX video, 1994.
- Hubble's Amazing Rescue*. PBS Nova, 2009.
- Hubble's Amazing Universe*. National Geographic Channel, 2008.
- Hubble's Diverse Universe*. Boag's Productions. DVD, 2010.
- Hubble's Cosmic Journey*. National Geographic Channel, 2015.

Myers, Toni, producer/director. *Hubble*. Warner Bros. pictures and IMAX filmed entertainment. IMAX DVD, 2011.

Rescue Mission in Space: The Hubble Space Telescope. PBS Nova, 1994.

STS-31 Mission Highlights Resource Tape. Washington, DC: NASA, 1990.

The Greatest: The Hubble Telescope. The Learning Channel, 1999.

Zucker, David, director. *The Naked Gun 2½: The Smell of Fear*. Paramount Pictures DVD, 1991.



ACKNOWLEDGMENTS

▲ Hubble image released in 2019 of a spiral galaxy called NGC 3717 in the constellation Hydra.

(ESA/Hubble/NASA/D. Rosario: potw1940a)

This book began when scientists and engineers at NASA's Goddard Space Flight Center decided that a history of Hubble Space Telescope operations should be written. This new historical work would complement Robert W. Smith's classic study, *The Space Telescope: A Study of NASA, Science, Technology and Politics*, which chronicled the lengthy process that brought HST to the point of launch. With support from historians at the NASA History Office and the Smithsonian Institution's National Air and Space Museum, NASA Goddard issued Request for Proposal NNG14500087Q in April 2014 for an academic quality history of HST operations and an archive of historical materials for future historians to draw on when creating future histories of HST.

I was encouraged that spring to compete for this contract by astronomer friends at the Dominion Astrophysical Observatory located near my home in Victoria, B.C., Canada, but I knew that it would require more than a single person to complete. I was soon contacted by John D. Ruley of Modesto, California, whom I did not know but who had recently completed the master's program in space studies from the University of North Dakota (UND), a program I had completed years before. Dr. Stephen B. Johnson, who had taught us both at UND, recommended John and I to each other. John was interested in creating the archive for this project, and he was also associated with Foresight Science & Technology, Inc., a technology commercialization and consulting company that specializes in accelerating the transition to market of technologies and in providing commercial evaluation and assistance for technologies supported by federal and state government agencies and laboratories.

I worked with John and Foresight on our successful bid for the competition, and Foresight signed a contract for our team with NASA Goddard in November 2014 to develop the book and the archive. Throughout the term of the contract, I worked closely with John, who developed an excellent online archive of

interviews and documents based on my research. John helped with many of the interviews I conducted while researching this book, and he also reviewed my drafts, provided valued advice, and joined me for some research trips. We both worked closely with Daniel M. Satinsky, Foresight's Vice President for Business Development, who ensured that our contract with NASA ran smoothly. We were also assisted by Phyl Speser, Norton Kaplan, and Arendt Speser of Foresight. Thanks are also due to our transcriptionist, Jane Dillingham of Transcription Professionals.

The archive was developed using the Omeka platform from George Mason University, and grew to include more than 22,000 scanned document pages, audio interviews (and in selected cases, high definition video) with some 80 interviewees, and over 150 still images. In total, 115 gigabytes of searchable data covering the history of the Hubble project from the telescope launch in 1990 through 2017 when the archive was delivered to NASA. This collection is now housed at NASA Headquarters, in the NASA History Division's archives, and is accessible to historians and other researchers.

At Goddard, James F. Jeletic, Deputy Project Manager for Hubble Space Telescope Operations, worked hard to make this book and the archive a reality. I would also like to recognize HST Project Manager Patrick L. Crouse and Jeannine A. Kashif, their Project Support Specialist, who provided invaluable help to both John and me. Kenneth G. Carpenter, HST Operations Project Scientist, was always available to assist us, and so was HST Senior Project Scientist Jennifer J. Wiseman. I received a great deal of help, advice, and support from Goddard Emeritus Astrophysicist Theodore R. Gull, Deputy HST Project Scientist for Operations Patricia T. (Padi) Boyd, Tod R. Lauer of the National Optical Astronomy Observatory, and former NASA Headquarters HST Program Scientist Harley A. Thronson. I interviewed many people at NASA Goddard, and I would like to express special thanks to David S. Leckrone, HST Senior Project Scientist from 1992 to 2009, whose three interviews covering his lengthy work with HST were especially valuable to my work.

James Reis, HST Grounds Systems Manager at Goddard, worked with John on creating the online archive. Holly A. McIntyre, Goddard's Archivist, provided valuable assistance to both of us in retrieving documents, along with Michael J. Chesnes, Heather Johnson, Jessica Deibert, Katrina Jackson, Jim White, and Amber N. Straughn. I called on Craig Neelands and Richard Dancy for advice on archival work.

The staff of the NASA History Division at NASA Headquarters in Washington, DC, also played crucial roles in the creation of this book. Stephen J. Garber reviewed drafts of this book, helped find information sources around

NASA, and was our main contact with the history office. Thanks are also due to NASA Chief Historian William P. Barry for his assistance and advice, and his predecessor Steven J. Dick, who generously shared the interviews and documents he gathered while researching his paper on NASA Administrator Sean O’Keefe’s decision to cancel HST Servicing Mission 4. Thanks also to Nadine Andreassen for her invaluable assistance. John and I worked with the late NASA Chief Archivist Jane H. Odom before her retirement, her successor Robyn Rodgers, and archivists John Hargenrader, Elizabeth Suckow, and Colin Fries, along with Gwen Pitman in the Headquarters Photo Library. Craig Tupper in the Science Mission Directorate supplied useful budget information on HST.

Many thanks to the exemplary production team in the Communications Support Services Center (CSSC). Shawna Byrd, Anne Factor, and Lisa Jirousek expertly copyedited the manuscript; Michele Ostovar did a wonderful job laying out the design; Tun Hla skillfully oversaw the printing and the entire production team. Additional thanks to Kristin Harley, who did an outstanding job of preparing the index. Thank you all for your skill, professionalism, and customer-friendly attitudes in bringing this book to fruition.

Throughout the development of this book and archive, we enjoyed full cooperation from everyone we dealt with at the Space Telescope Science Institute in Baltimore, Maryland, including Directors C. M. “Matt” Mountain and Kenneth R. Sembach. Hussein Jirdeh, Head of Communications and Public Outreach, and his staff were unfailingly helpful. Helmut Jenkner helped introduce me to the inner workings of the Institute, and Neill Reid was always available to educate me in the workings of the time allocation process for HST. I had known STScI’s longtime News Chief and Public Information Manager, Ray Villard, for 20 years before I started on this book, and Ray’s insights and friendship were invaluable for my work. STScI Chief Librarian Jill Lagerstrom was always eager to help me find important documents, and her successor Jenny Novacescu picked up where Jill left off. Roslyn Baxter, Ann Jenkins, Cheryl Gundy, Sherita Hanna, and Martha Devaud also helped. Many Institute scientists past and present are on the list of people who granted interviews.

Historians at the National Air and Space Museum of the Smithsonian Institution provided me with invaluable assistance. David H. DeVorkin, who has coauthored several books on HST, provided vital critical commentary on my drafts and a great deal of helpful advice. I would also like to thank Roger D. Launius, Michael J. Neufeld, Paul E. Ceruzzi, Valerie Neal, Margaret Weitekamp, and James E. David for their advice and assistance.

Historian Erik M. Conway and archivist Julie A. Cooper made our visit to the Jet Propulsion Laboratory in California profitable. Rosalyn H. Brown

facilitated my interviews at Ball Aerospace in Boulder, Colorado, as did Lynne Vanin at MDA in Brampton, Ontario, and Patricia Alvarez at Lockheed Martin in Littleton, Colorado. I interviewed several astronauts for this book, and I also profited from unrecorded discussions with astronauts Kathryn D. Sullivan and Steven L. Smith. Dr. Sullivan made an even bigger contribution to my work with many helpful comments on a draft of this book and by sharing the galleys of her own excellent book on her experiences with HST, *Handprints on Hubble: An Astronaut's Story of Invention*.

An important source of documents for this book and the archive was the Rare Books and Manuscripts Department of the Milton S. Eisenhower Library at Johns Hopkins University in Baltimore, Maryland. Senior Reference Archivist James Stimpert and his staff were always ready to help when I needed to consult the Space Telescope Collection there that was assembled by Robert W. Smith while writing *The Space Telescope*, and the Space Telescope Science Institute Collection that was assembled by Daniel Golombek while he worked at STScI. Golombek, who worked at the American Institute of Physics while I researched this book, was also helpful, and the AIP proved to be a useful source for information in my work.

I am most grateful to Maria J. Wood, who lent me the journals and other materials created by her late husband, H. John Wood, while he worked to overcome HST's spherical aberration problem during his career at NASA Goddard. Lick Observatory astrophysicist Sandra M. Faber made available the diaries she kept while she and other members of the WF/PC team first encountered and flushed out the spherical aberration that afflicted HST. Elizabeth Kessler of Stanford University provided documents related to the Hubble Heritage Program. Rick Fienberg, the Press Officer of the American Astronomical Society, helped me keep up to date with astronomical news. I also consulted with John M. Logsdon and Scott Pace of the Space Policy Institute at George Washington University, Dwayne A. Day of the National Research Council, and Joanne Leung at MDA.

Throughout my work on this project I have received encouragement and a great deal of useful advice from my friends at the Dominion Astrophysical Observatory. James E. Hesser served for many years as DAO director and is a valued friend along with his wife Betty. John B. Hutchings shared his extensive knowledge of HST, supplemented by records of meetings at STScI. Laura Ferrarese, whose many accomplishments include a Hubble Fellowship, was always available to answer my questions about cosmology. Dennis Crabtree introduced me to the Canadian Astronomy Data Centre and its trove of HST

data long before I started on this book. I have also been assisted by Patrick Côté and James Di Francesco.

In addition to the libraries and archives mentioned above, I called on the resources of the Library of Congress and libraries at the University of Victoria, University of Washington, University of British Columbia, and the University of Alberta.

I want to extend a special thanks to Professor Robert W. Smith of the University of Alberta. In addition to being the author of *The Space Telescope* and many other works on HST, he was my faculty advisor during my Ph.D. studies, and he has been a constant source of advice and encouragement since that time, especially for this book, which has also benefitted from his critical reading of a draft manuscript. I also want to thank other anonymous reviewers of my manuscript, who all have made it better. Remaining deficiencies in this work are the responsibility of the author.

In the 1990s, the late Barry Shanko introduced me to people like Ray Villard at STScI and Dennis Crabtree at the DAO, and he reintroduced me to the Royal Astronomical Society of Canada. He has also helped out with this book by sharing books and media guides I otherwise wouldn't have found.

I also wish to thank Paul Fjeld, Randy Attwood, Randall Rosenfeld, Scott Sacknoff, David Baker, Ken Harman, Matt Nelson, Margaret Panton, Will Offley, Rolf Maurer, Steve Pacholuk, Steve Shallhorn, Marcus Gee, Kate Andrew, Sue Birge, Shawn Strandberg, Martha Starr, Forrest McCluer, Charity Weeden, Brian Weeden, Rob Cottingham, and Bob Hupfer.

None of my work would have possible without the support of my wife Audrey McClellan.

INTERVIEWS

Albrecht, Rudolf	11/09/2015
Ayres, Thomas R.	09/23/2015
Bahcall, Neta A.	08/31/2016
Bahcall, Neta A.	09/01/2016
Beckwith, Steven V. W.	09/26/2016
Boggess, Albert	09/21/2015
Bolden, Jr., Charles F.	10/31/2017
Boyd, Patricia T. (Padi)	06/13/2016
Brown, Robert A.	12/14/2016
Burch, Preston M.	11/09/2015
Burch, Preston M.	06/07/2017
Burrows, Christopher J.	02/15/2017

Campbell, John H.	05/22/2017
Carpenter, Kenneth G.	04/30/2015
Cepollina, Frank J.	05/08/2015
Cheng, Edward S.	06/17/2017
Coffman, Phil	04/10/2015 (Interview by John Ruley)
Crabb, William G.	01/04/2018
Crabtree, Dennis; Durand, Daniel; and Woodsworth, Andrew	08/17/2017
Crocker, James H.	09/21/2015
Crouse, Patrick L.	06/17/2016
Dalcanton, Julianne	02/16/2017
Dunham, Larry	09/19/2017
Ebbetts, Dennis	09/22/2015
Ebbetts, Dennis; LaPole, Mark; Lightsey, Paul; and Sullivan, Joseph F.	09/22/2015
Faber, Sandra M.	09/29/2016
Ford, Holland C.	10/31/2015
Freedman, Wendy L.	09/06/2017
Goldin, Daniel S.	08/07/2017
Green, James C. and Michael Shull	09/24/2015
Griffin, Michael D.	05/22/2017
Grunsfeld, John M.	11/02/2016
Gull, Theodore R.	05/22/2015
Hammel, Heidi B.	05/18/2017
Haskins, David N.	06/15/2016
Heap, Sara R. (Sally)	05/22/2015
Hester, John J. (Jeff)	03/20/2017
Hiltz, Michael	10/21/2015
Hutchings, John B.	03/30/2015
Jeletic, James F.	05/19/2017
Jenkner, Helmut	05/19/2015
Kimble, Randy A.	11/01/2016
Kirshner, Robert P.	09/28/2016
LaPole, Mark	09/22/2015
Larson, Ana M.	11/28/2017
Lauer, Tod R.	08/15/2016
Leckrone, David S.	05/06/2015
Leckrone, David S.	11/06/2015
Leckrone, David S.	06/13/2016

Levay, Zoltan G.	06/08/2016
Lightsey, Paul A.	09/22/2015
Linsky, Jeffrey L.	09/18/2015
Livio, Mario	05/19/2015
Livio, Mario	05/20/2015
Macchetto, F. Duccio	05/09/2017
Mountain, C. M. (Matt)	11/04/2016
Musgrave, F. Story	10/25/2015
Niedner, Malcolm B., Jr.	11/10/2015
Noll, Keith S.	05/15/2017
Nota, Antonella	05/17/2017
O'Keefe, Sean C.	06/05/2017
Pellerin, Charles J.	09/17/2017
Polidan, Ronald S.	08/18/2016
Ratti, John	10/21/2015
Reid, I. Neill	11/02/2016
Reis, James	12/11/2017 (Interview by John Ruley)
Riess, Adam G.	05/20/2015
Rothenberg, Joseph H.	09/27/2016
Ruitberg, Edward O.	05/16/2017
Sembach, Kenneth R.	05/25/2017
Sheffield, Ronald	09/30/2016
Suntzeff, Nicholas B.	06/07/2016
Tanner, Joseph R.	09/20/2015
Thronson, Harley A.	05/12/2015
Trauger, John T.	10/03/2016
Troeltzch, John R.	09/22/2015
Villard, Ray	10/30/2015
Villard, Ray	11/04/2016
Weiler, Edward J.	10/24/2016
Williams, Robert E.	05/21/2015
Wiseman, Jennifer J.	05/08/2015



THE NASA HISTORY SERIES

▲ Hubble's WFC3 was used to probe the Eta Carinae star in ultraviolet light, uncovering the glow of magnesium embedded in warm gas. (NASA/ESA/N. Smith [University of Arizona]/J. Morse [BoldlyGo Institute]: heic1912a)

REFERENCE WORKS, NASA SP-4000

Grimwood, James M. *Project Mercury: A Chronology*. NASA SP-4001, 1963.

Grimwood, James M., and Barton C. Hacker, with Peter J. Vorzimmer. *Project Gemini Technology and Operations: A Chronology*. NASA SP-4002, 1969.

Link, Mae Mills. *Space Medicine in Project Mercury*. NASA SP-4003, 1965.

Astronautics and Aeronautics, 1963: Chronology of Science, Technology, and Policy. NASA SP-4004, 1964.

Astronautics and Aeronautics, 1964: Chronology of Science, Technology, and Policy. NASA SP-4005, 1965.

Astronautics and Aeronautics, 1965: Chronology of Science, Technology, and Policy. NASA SP-4006, 1966.

Astronautics and Aeronautics, 1966: Chronology of Science, Technology, and Policy. NASA SP-4007, 1967.

Astronautics and Aeronautics, 1967: Chronology of Science, Technology, and Policy. NASA SP-4008, 1968.

Ertel, Ivan D., and Mary Louise Morse. *The Apollo Spacecraft: A Chronology, Volume I, Through November 7, 1962*. NASA SP-4009, 1969.

Morse, Mary Louise, and Jean Kernahan Bays. *The Apollo Spacecraft: A Chronology, Volume II, November 8, 1962–September 30, 1964*. NASA SP-4009, 1973.

Brooks, Courtney G., and Ivan D. Ertel. *The Apollo Spacecraft: A Chronology, Volume III, October 1, 1964–January 20, 1966*. NASA SP-4009, 1973.

Ertel, Ivan D., and Roland W. Newkirk, with Courtney G. Brooks. *The Apollo Spacecraft: A Chronology, Volume IV, January 21, 1966–July 13, 1974*. NASA SP-4009, 1978.

Astronautics and Aeronautics, 1968: Chronology of Science, Technology, and Policy. NASA SP-4010, 1969.

- Newkirk, Roland W., and Ivan D. Ertel, with Courtney G. Brooks. *Skylab: A Chronology*. NASA SP-4011, 1977.
- Van Nimmen, Jane, and Leonard C. Bruno, with Robert L. Rosholt. *NASA Historical Data Book, Volume I: NASA Resources, 1958–1968*. NASA SP-4012, 1976; rep. ed. 1988.
- Ezell, Linda Neuman. *NASA Historical Data Book, Volume II: Programs and Projects, 1958–1968*. NASA SP-4012, 1988.
- Ezell, Linda Neuman. *NASA Historical Data Book, Volume III: Programs and Projects, 1969–1978*. NASA SP-4012, 1988.
- Gawdiak, Ihor, with Helen Fedor. *NASA Historical Data Book, Volume IV: NASA Resources, 1969–1978*. NASA SP-4012, 1994.
- Rumerman, Judy A. *NASA Historical Data Book, Volume V: NASA Launch Systems, Space Transportation, Human Spaceflight, and Space Science, 1979–1988*. NASA SP-4012, 1999.
- Rumerman, Judy A. *NASA Historical Data Book, Volume VI: NASA Space Applications, Aeronautics and Space Research and Technology, Tracking and Data Acquisition/Support Operations, Commercial Programs, and Resources, 1979–1988*. NASA SP-4012, 1999.
- Rumerman, Judy A. *NASA Historical Data Book, Volume VII: NASA Launch Systems, Space Transportation, Human Spaceflight, and Space Science, 1989–1998*. NASA SP-2009-4012, 2009.
- Rumerman, Judy A. *NASA Historical Data Book, Volume VIII: NASA Earth Science and Space Applications, Aeronautics, Technology, and Exploration, Tracking and Data Acquisition/Space Operations, Facilities and Resources, 1989–1998*. NASA SP-2012-4012, 2012.
- No SP-4013.
- Astronautics and Aeronautics, 1969: Chronology of Science, Technology, and Policy*. NASA SP-4014, 1970.
- Astronautics and Aeronautics, 1970: Chronology of Science, Technology, and Policy*. NASA SP-4015, 1972.
- Astronautics and Aeronautics, 1971: Chronology of Science, Technology, and Policy*. NASA SP-4016, 1972.
- Astronautics and Aeronautics, 1972: Chronology of Science, Technology, and Policy*. NASA SP-4017, 1974.
- Astronautics and Aeronautics, 1973: Chronology of Science, Technology, and Policy*. NASA SP-4018, 1975.
- Astronautics and Aeronautics, 1974: Chronology of Science, Technology, and Policy*. NASA SP-4019, 1977.

- Astronautics and Aeronautics, 1975: Chronology of Science, Technology, and Policy.* NASA SP-4020, 1979.
- Astronautics and Aeronautics, 1976: Chronology of Science, Technology, and Policy.* NASA SP-4021, 1984.
- Astronautics and Aeronautics, 1977: Chronology of Science, Technology, and Policy.* NASA SP-4022, 1986.
- Astronautics and Aeronautics, 1978: Chronology of Science, Technology, and Policy.* NASA SP-4023, 1986.
- Astronautics and Aeronautics, 1979–1984: Chronology of Science, Technology, and Policy.* NASA SP-4024, 1988.
- Astronautics and Aeronautics, 1985: Chronology of Science, Technology, and Policy.* NASA SP-4025, 1990.
- Noordung, Hermann. *The Problem of Space Travel: The Rocket Motor.* Edited by Ernst Stuhlinger and J. D. Hunley, with Jennifer Garland. NASA SP-4026, 1995.
- Gawdiak, Ihor Y., Ramon J. Miro, and Sam Stueland. *Astronautics and Aeronautics, 1986–1990: A Chronology.* NASA SP-4027, 1997.
- Gawdiak, Ihor Y., and Charles Shetland. *Astronautics and Aeronautics, 1991–1995: A Chronology.* NASA SP-2000-4028, 2000.
- Orloff, Richard W. *Apollo by the Numbers: A Statistical Reference.* NASA SP-2000-4029, 2000.
- Lewis, Marieke, and Ryan Swanson. *Astronautics and Aeronautics: A Chronology, 1996–2000.* NASA SP-2009-4030, 2009.
- Ivey, William Noel, and Marieke Lewis. *Astronautics and Aeronautics: A Chronology, 2001–2005.* NASA SP-2010-4031, 2010.
- Buchalter, Alice R., and William Noel Ivey. *Astronautics and Aeronautics: A Chronology, 2006.* NASA SP-2011-4032, 2010.
- Lewis, Marieke. *Astronautics and Aeronautics: A Chronology, 2007.* NASA SP-2011-4033, 2011.
- Lewis, Marieke. *Astronautics and Aeronautics: A Chronology, 2008.* NASA SP-2012-4034, 2012.
- Lewis, Marieke. *Astronautics and Aeronautics: A Chronology, 2009.* NASA SP-2012-4035, 2012.
- Flattery, Meaghan. *Astronautics and Aeronautics: A Chronology, 2010.* NASA SP-2013-4037, 2014.
- Siddiqi, Asif A. *Beyond Earth: A Chronicle of Deep Space Exploration, 1958–2016.* NASA SP-2018-4041, 2018.

MANAGEMENT HISTORIES, NASA SP-4100

- Rosholt, Robert L. *An Administrative History of NASA, 1958–1963*. NASA SP-4101, 1966.
- Levine, Arnold S. *Managing NASA in the Apollo Era*. NASA SP-4102, 1982.
- Roland, Alex. *Model Research: The National Advisory Committee for Aeronautics, 1915–1958*. NASA SP-4103, 1985.
- Fries, Sylvia D. *NASA Engineers and the Age of Apollo*. NASA SP-4104, 1992.
- Glennan, T. Keith. *The Birth of NASA: The Diary of T. Keith Glennan*. Edited by J. D. Hunley. NASA SP-4105, 1993.
- Seamans, Robert C. *Aiming at Targets: The Autobiography of Robert C. Seamans*. NASA SP-4106, 1996.
- Garber, Stephen J., ed. *Looking Backward, Looking Forward: Forty Years of Human Spaceflight Symposium*. NASA SP-2002-4107, 2002.
- Mallick, Donald L., with Peter W. Merlin. *The Smell of Kerosene: A Test Pilot's Odyssey*. NASA SP-4108, 2003.
- Iloff, Kenneth W., and Curtis L. Peebles. *From Runway to Orbit: Reflections of a NASA Engineer*. NASA SP-2004-4109, 2004.
- Chertok, Boris. *Rockets and People, Volume I*. NASA SP-2005-4110, 2005.
- Chertok, Boris. *Rockets and People: Creating a Rocket Industry, Volume II*. NASA SP-2006-4110, 2006.
- Chertok, Boris. *Rockets and People: Hot Days of the Cold War, Volume III*. NASA SP-2009-4110, 2009.
- Chertok, Boris. *Rockets and People: The Moon Race, Volume IV*. NASA SP-2011-4110, 2011.
- Laufer, Alexander, Todd Post, and Edward Hoffman. *Shared Voyage: Learning and Unlearning from Remarkable Projects*. NASA SP-2005-4111, 2005.
- Dawson, Virginia P., and Mark D. Bowles. *Realizing the Dream of Flight: Biographical Essays in Honor of the Centennial of Flight, 1903–2003*. NASA SP-2005-4112, 2005.
- Mudgway, Douglas J. *William H. Pickering: America's Deep Space Pioneer*. NASA SP-2008-4113, 2008.
- Wright, Rebecca, Sandra Johnson, and Steven J. Dick. *NASA at 50: Interviews with NASA's Senior Leadership*. NASA SP-2012-4114, 2012.

PROJECT HISTORIES, NASA SP-4200

- Swenson, Loyd S., Jr., James M. Grimwood, and Charles C. Alexander. *This New Ocean: A History of Project Mercury*. NASA SP-4201, 1966; rep. ed. 1999.

- Green, Constance McLaughlin, and Milton Lomask. *Vanguard: A History*. NASA SP-4202, 1970; rep. ed. Smithsonian Institution Press, 1971.
- Hacker, Barton C., and James M. Grimwood. *On the Shoulders of Titans: A History of Project Gemini*. NASA SP-4203, 1977; rep. ed. 2002.
- Benson, Charles D., and William Barnaby Faherty. *Moonport: A History of Apollo Launch Facilities and Operations*. NASA SP-4204, 1978.
- Brooks, Courtney G., James M. Grimwood, and Loyd S. Swenson, Jr. *Chariots for Apollo: A History of Manned Lunar Spacecraft*. NASA SP-4205, 1979.
- Bilstein, Roger E. *Stages to Saturn: A Technological History of the Apollo/Saturn Launch Vehicles*. NASA SP-4206, 1980 and 1996.
- No SP-4207.
- Compton, W. David, and Charles D. Benson. *Living and Working in Space: A History of Skylab*. NASA SP-4208, 1983.
- Ezell, Edward Clinton, and Linda Neuman Ezell. *The Partnership: A History of the Apollo-Soyuz Test Project*. NASA SP-4209, 1978.
- Hall, R. Cargill. *Lunar Impact: A History of Project Ranger*. NASA SP-4210, 1977.
- Newell, Homer E. *Beyond the Atmosphere: Early Years of Space Science*. NASA SP-4211, 1980.
- Ezell, Edward Clinton, and Linda Neuman Ezell. *On Mars: Exploration of the Red Planet, 1958–1978*. NASA SP-4212, 1984.
- Pitts, John A. *The Human Factor: Biomedicine in the Manned Space Program to 1980*. NASA SP-4213, 1985.
- Compton, W. David. *Where No Man Has Gone Before: A History of Apollo Lunar Exploration Missions*. NASA SP-4214, 1989.
- Naugle, John E. *First Among Equals: The Selection of NASA Space Science Experiments*. NASA SP-4215, 1991.
- Wallace, Lane E. *Airborne Trailblazer: Two Decades with NASA Langley's 737 Flying Laboratory*. NASA SP-4216, 1994.
- Butrica, Andrew J., ed. *Beyond the Ionosphere: Fifty Years of Satellite Communications*. NASA SP-4217, 1997.
- Butrica, Andrew J. *To See the Unseen: A History of Planetary Radar Astronomy*. NASA SP-4218, 1996.
- Mack, Pamela E., ed. *From Engineering Science to Big Science: The NACA and NASA Collier Trophy Research Project Winners*. NASA SP-4219, 1998.
- Reed, R. Dale. *Wingless Flight: The Lifting Body Story*. NASA SP-4220, 1998.
- Heppenheimer, T. A. *The Space Shuttle Decision: NASA's Search for a Reusable Space Vehicle*. NASA SP-4221, 1999.

- Hunley, J. D., ed. *Toward Mach 2: The Douglas D-558 Program*. NASA SP-4222, 1999.
- Swanson, Glen E., ed. "Before This Decade Is Out..." *Personal Reflections on the Apollo Program*. NASA SP-4223, 1999.
- Tomayko, James E. *Computers Take Flight: A History of NASA's Pioneering Digital Fly-By-Wire Project*. NASA SP-4224, 2000.
- Morgan, Clay. *Shuttle-Mir: The United States and Russia Share History's Highest Stage*. NASA SP-2001-4225, 2001.
- Leary, William M. "We Freeze to Please": *A History of NASA's Icing Research Tunnel and the Quest for Safety*. NASA SP-2002-4226, 2002.
- Mudgway, Douglas J. *Uplink-Downlink: A History of the Deep Space Network, 1957–1997*. NASA SP-2001-4227, 2001.
- No SP-4228 or SP-4229.
- Dawson, Virginia P., and Mark D. Bowles. *Taming Liquid Hydrogen: The Centaur Upper Stage Rocket, 1958–2002*. NASA SP-2004-4230, 2004.
- Meltzer, Michael. *Mission to Jupiter: A History of the Galileo Project*. NASA SP-2007-4231, 2007.
- Heppenheimer, T. A. *Facing the Heat Barrier: A History of Hypersonics*. NASA SP-2007-4232, 2007.
- Tsiao, Sunny. "Read You Loud and Clear!" *The Story of NASA's Spaceflight Tracking and Data Network*. NASA SP-2007-4233, 2007.
- Meltzer, Michael. *When Biospheres Collide: A History of NASA's Planetary Protection Programs*. NASA SP-2011-4234, 2011.
- Gainor, Christopher. *Not Yet Imagined: A Study of Hubble Space Telescope Operations*. NASA SP-2020-4237, 2020.

CENTER HISTORIES, NASA SP-4300

- Rosenthal, Alfred. *Venture into Space: Early Years of Goddard Space Flight Center*. NASA SP-4301, 1985.
- Hartman, Edwin P. *Adventures in Research: A History of Ames Research Center, 1940–1965*. NASA SP-4302, 1970.
- Hallion, Richard P. *On the Frontier: Flight Research at Dryden, 1946–1981*. NASA SP-4303, 1984.
- Muenger, Elizabeth A. *Searching the Horizon: A History of Ames Research Center, 1940–1976*. NASA SP-4304, 1985.
- Hansen, James R. *Engineer in Charge: A History of the Langley Aeronautical Laboratory, 1917–1958*. NASA SP-4305, 1987.
- Dawson, Virginia P. *Engines and Innovation: Lewis Laboratory and American Propulsion Technology*. NASA SP-4306, 1991.

- Dethloff, Henry C. *“Suddenly Tomorrow Came...”: A History of the Johnson Space Center, 1957–1990*. NASA SP-4307, 1993.
- Hansen, James R. *Spaceflight Revolution: NASA Langley Research Center from Sputnik to Apollo*. NASA SP-4308, 1995.
- Wallace, Lane E. *Flights of Discovery: An Illustrated History of the Dryden Flight Research Center*. NASA SP-4309, 1996.
- Herring, Mack R. *Way Station to Space: A History of the John C. Stennis Space Center*. NASA SP-4310, 1997.
- Wallace, Harold D., Jr. *Wallops Station and the Creation of an American Space Program*. NASA SP-4311, 1997.
- Wallace, Lane E. *Dreams, Hopes, Realities. NASA's Goddard Space Flight Center: The First Forty Years*. NASA SP-4312, 1999.
- Dunar, Andrew J., and Stephen P. Waring. *Power to Explore: A History of Marshall Space Flight Center, 1960–1990*. NASA SP-4313, 1999.
- Bugos, Glenn E. *Atmosphere of Freedom: Sixty Years at the NASA Ames Research Center*. NASA SP-2000-4314, 2000.
- Bugos, Glenn E. *Atmosphere of Freedom: Seventy Years at the NASA Ames Research Center*. NASA SP-2010-4314, 2010. Revised version of NASA SP-2000-4314.
- Bugos, Glenn E. *Atmosphere of Freedom: Seventy Five Years at the NASA Ames Research Center*. NASA SP-2014-4314, 2014. Revised version of NASA SP-2000-4314.
- No SP-4315.
- Schultz, James. *Crafting Flight: Aircraft Pioneers and the Contributions of the Men and Women of NASA Langley Research Center*. NASA SP-2003-4316, 2003.
- Bowles, Mark D. *Science in Flux: NASA's Nuclear Program at Plum Brook Station, 1955–2005*. NASA SP-2006-4317, 2006.
- Wallace, Lane E. *Flights of Discovery: An Illustrated History of the Dryden Flight Research Center*. NASA SP-2007-4318, 2007. Revised version of NASA SP-4309.
- Arrighi, Robert S. *Revolutionary Atmosphere: The Story of the Altitude Wind Tunnel and the Space Power Chambers*. NASA SP-2010-4319, 2010.

GENERAL HISTORIES, NASA SP-4400

- Corliss, William R. *NASA Sounding Rockets, 1958–1968: A Historical Summary*. NASA SP-4401, 1971.
- Wells, Helen T., Susan H. Whiteley, and Carrie Karegeannes. *Origins of NASA Names*. NASA SP-4402, 1976.

- Anderson, Frank W., Jr. *Orders of Magnitude: A History of NACA and NASA, 1915–1980*. NASA SP-4403, 1981.
- Sloop, John L. *Liquid Hydrogen as a Propulsion Fuel, 1945–1959*. NASA SP-4404, 1978.
- Roland, Alex. *A Spacefaring People: Perspectives on Early Spaceflight*. NASA SP-4405, 1985.
- Bilstein, Roger E. *Orders of Magnitude: A History of the NACA and NASA, 1915–1990*. NASA SP-4406, 1989.
- Logsdon, John M., ed., with Linda J. Lear, Jannelle Warren Findley, Ray A. Williamson, and Dwayne A. Day. *Exploring the Unknown: Selected Documents in the History of the U.S. Civil Space Program, Volume I: Organizing for Exploration*. NASA SP-4407, 1995.
- Logsdon, John M., ed., with Dwayne A. Day and Roger D. Launius. *Exploring the Unknown: Selected Documents in the History of the U.S. Civil Space Program, Volume II: External Relationships*. NASA SP-4407, 1996.
- Logsdon, John M., ed., with Roger D. Launius, David H. Onkst, and Stephen J. Garber. *Exploring the Unknown: Selected Documents in the History of the U.S. Civil Space Program, Volume III: Using Space*. NASA SP-4407, 1998.
- Logsdon, John M., ed., with Ray A. Williamson, Roger D. Launius, Russell J. Acker, Stephen J. Garber, and Jonathan L. Friedman. *Exploring the Unknown: Selected Documents in the History of the U.S. Civil Space Program, Volume IV: Accessing Space*. NASA SP-4407, 1999.
- Logsdon, John M., ed., with Amy Paige Snyder, Roger D. Launius, Stephen J. Garber, and Regan Anne Newport. *Exploring the Unknown: Selected Documents in the History of the U.S. Civil Space Program, Volume V: Exploring the Cosmos*. NASA SP-2001-4407, 2001.
- Logsdon, John M., ed., with Stephen J. Garber, Roger D. Launius, and Ray A. Williamson. *Exploring the Unknown: Selected Documents in the History of the U.S. Civil Space Program, Volume VI: Space and Earth Science*. NASA SP-2004-4407, 2004.
- Logsdon, John M., ed., with Roger D. Launius. *Exploring the Unknown: Selected Documents in the History of the U.S. Civil Space Program, Volume VII: Human Spaceflight: Projects Mercury, Gemini, and Apollo*. NASA SP-2008-4407, 2008.
- Siddiqi, Asif A., *Challenge to Apollo: The Soviet Union and the Space Race, 1945–1974*. NASA SP-2000-4408, 2000.
- Hansen, James R., ed. *The Wind and Beyond: Journey into the History of Aerodynamics in America, Volume 1: The Ascent of the Airplane*. NASA SP-2003-4409, 2003.

- Hansen, James R., ed. *The Wind and Beyond: Journey into the History of Aerodynamics in America, Volume 2: Reinventing the Airplane*. NASA SP-2007-4409, 2007.
- Hogan, Thor. *Mars Wars: The Rise and Fall of the Space Exploration Initiative*. NASA SP-2007-4410, 2007.
- Vakoch, Douglas A., ed. *Psychology of Space Exploration: Contemporary Research in Historical Perspective*. NASA SP-2011-4411, 2011.
- Ferguson, Robert G. *NASA's First A: Aeronautics from 1958 to 2008*. NASA SP-2012-4412, 2013.
- Vakoch, Douglas A., ed. *Archaeology, Anthropology, and Interstellar Communication*. NASA SP-2013-4413, 2014.
- Asner, Glen R., and Stephen J. Garber. *Origins of 21st-Century Space Travel: A History of NASA's Decadal Planning Team and the Vision for Space Exploration, 1999–2004*. NASA SP-2019-4415, 2019.

MONOGRAPHS IN AEROSPACE HISTORY, NASA SP-4500

- Launius, Roger D., and Aaron K. Gillette, comps. *Toward a History of the Space Shuttle: An Annotated Bibliography*. Monographs in Aerospace History, No. 1, 1992.
- Launius, Roger D., and J. D. Hunley, comps. *An Annotated Bibliography of the Apollo Program*. Monographs in Aerospace History, No. 2, 1994.
- Launius, Roger D. *Apollo: A Retrospective Analysis*. Monographs in Aerospace History, No. 3, 1994.
- Hansen, James R. *Enchanted Rendezvous: John C. Houbolt and the Genesis of the Lunar-Orbit Rendezvous Concept*. Monographs in Aerospace History, No. 4, 1995.
- Gorn, Michael H. *Hugh L. Dryden's Career in Aviation and Space*. Monographs in Aerospace History, No. 5, 1996.
- Powers, Sheryll Goecke. *Women in Flight Research at NASA Dryden Flight Research Center from 1946 to 1995*. Monographs in Aerospace History, No. 6, 1997.
- Portree, David S. F., and Robert C. Trevino. *Walking to Olympus: An EVA Chronology*. Monographs in Aerospace History, No. 7, 1997.
- Logsdon, John M., moderator. *Legislative Origins of the National Aeronautics and Space Act of 1958: Proceedings of an Oral History Workshop*. Monographs in Aerospace History, No. 8, 1998.
- Rumerman, Judy A., comp. *U.S. Human Spaceflight: A Record of Achievement, 1961–1998*. Monographs in Aerospace History, No. 9, 1998.

- Portree, David S. F. *NASA's Origins and the Dawn of the Space Age*. Monographs in Aerospace History, No. 10, 1998.
- Logsdon, John M. *Together in Orbit: The Origins of International Cooperation in the Space Station*. Monographs in Aerospace History, No. 11, 1998.
- Phillips, W. Hewitt. *Journey in Aeronautical Research: A Career at NASA Langley Research Center*. Monographs in Aerospace History, No. 12, 1998.
- Braslow, Albert L. *A History of Suction-Type Laminar-Flow Control with Emphasis on Flight Research*. Monographs in Aerospace History, No. 13, 1999.
- Logsdon, John M., moderator. *Managing the Moon Program: Lessons Learned from Apollo*. Monographs in Aerospace History, No. 14, 1999.
- Perminov, V. G. *The Difficult Road to Mars: A Brief History of Mars Exploration in the Soviet Union*. Monographs in Aerospace History, No. 15, 1999.
- Tucker, Tom. *Touchdown: The Development of Propulsion Controlled Aircraft at NASA Dryden*. Monographs in Aerospace History, No. 16, 1999.
- Maisel, Martin, Demo J. Giulianetti, and Daniel C. Dugan. *The History of the XV-15 Tilt Rotor Research Aircraft: From Concept to Flight*. Monographs in Aerospace History, No. 17, 2000. NASA SP-2000-4517.
- Jenkins, Dennis R. *Hypersonics Before the Shuttle: A Concise History of the X-15 Research Airplane*. Monographs in Aerospace History, No. 18, 2000. NASA SP-2000-4518.
- Chambers, Joseph R. *Partners in Freedom: Contributions of the Langley Research Center to U.S. Military Aircraft of the 1990s*. Monographs in Aerospace History, No. 19, 2000. NASA SP-2000-4519.
- Waltman, Gene L. *Black Magic and Gremlins: Analog Flight Simulations at NASA's Flight Research Center*. Monographs in Aerospace History, No. 20, 2000. NASA SP-2000-4520.
- Portree, David S. F. *Humans to Mars: Fifty Years of Mission Planning, 1950–2000*. Monographs in Aerospace History, No. 21, 2001. NASA SP-2001-4521.
- Thompson, Milton O., with J. D. Hunley. *Flight Research: Problems Encountered and What They Should Teach Us*. Monographs in Aerospace History, No. 22, 2001. NASA SP-2001-4522.
- Tucker, Tom. *The Eclipse Project*. Monographs in Aerospace History, No. 23, 2001. NASA SP-2001-4523.
- Siddiqi, Asif A. *Deep Space Chronicle: A Chronology of Deep Space and Planetary Probes, 1958–2000*. Monographs in Aerospace History, No. 24, 2002. NASA SP-2002-4524.

Merlin, Peter W. *Mach 3+ : NASA/USAF YF-12 Flight Research, 1969–1979*.

Monographs in Aerospace History, No. 25, 2001. NASA SP-2001-4525.

Anderson, Seth B. *Memoirs of an Aeronautical Engineer: Flight Tests at Ames*

Research Center: 1940–1970. Monographs in Aerospace History, No. 26, 2002. NASA SP-2002-4526.

Renstrom, Arthur G. *Wilbur and Orville Wright: A Bibliography*

Commemorating the One-Hundredth Anniversary of the First Powered Flight on December 17, 1903. Monographs in Aerospace History, No. 27, 2002.

NASA SP-2002-4527.

No monograph 28.

Chambers, Joseph R. *Concept to Reality: Contributions of the NASA Langley*

Research Center to U.S. Civil Aircraft of the 1990s. Monographs in Aerospace History, No. 29, 2003. NASA SP-2003-4529.

Peebles, Curtis, ed. *The Spoken Word: Recollections of Dryden History, The*

Early Years. Monographs in Aerospace History, No. 30, 2003. NASA SP-2003-4530.

Jenkins, Dennis R., Tony Landis, and Jay Miller. *American X-Vehicles: An*

Inventory—X-1 to X-50. Monographs in Aerospace History, No. 31, 2003. NASA SP-2003-4531.

Renstrom, Arthur G. *Wilbur and Orville Wright: A Chronology*

Commemorating the One-Hundredth Anniversary of the First Powered Flight on December 17, 1903. Monographs in Aerospace History, No. 32, 2003.

NASA SP-2003-4532.

Bowles, Mark D., and Robert S. Arrighi. *NASA's Nuclear Frontier: The Plum Brook Research Reactor*. Monographs in Aerospace History, No. 33, 2004.

NASA SP-2004-4533.

Wallace, Lane, and Christian Gelzer. *Nose Up: High Angle-of-Attack and*

Thrust Vectoring Research at NASA Dryden, 1979–2001. Monographs in Aerospace History, No. 34, 2009. NASA SP-2009-4534.

Matranga, Gene J., C. Wayne Ottinger, Calvin R. Jarvis, and D. Christian

Gelzer. *Unconventional, Contrary, and Ugly: The Lunar Landing Research Vehicle*. Monographs in Aerospace History, No. 35, 2006. NASA

SP-2004-4535.

McCurdy, Howard E. *Low-Cost Innovation in Spaceflight: The History of*

the Near Earth Asteroid Rendezvous (NEAR) Mission. Monographs in Aerospace History, No. 36, 2005. NASA SP-2005-4536.

Seamans, Robert C., Jr. *Project Apollo: The Tough Decisions*. Monographs in

Aerospace History, No. 37, 2005. NASA SP-2005-4537.

- Lambright, W. Henry. *NASA and the Environment: The Case of Ozone Depletion*. Monographs in Aerospace History, No. 38, 2005. NASA SP-2005-4538.
- Chambers, Joseph R. *Innovation in Flight: Research of the NASA Langley Research Center on Revolutionary Advanced Concepts for Aeronautics*. Monographs in Aerospace History, No. 39, 2005. NASA SP-2005-4539.
- Phillips, W. Hewitt. *Journey into Space Research: Continuation of a Career at NASA Langley Research Center*. Monographs in Aerospace History, No. 40, 2005. NASA SP-2005-4540.
- Rumerman, Judy A., Chris Gamble, and Gabriel Okolski, comps. *U.S. Human Spaceflight: A Record of Achievement, 1961–2006*. Monographs in Aerospace History, No. 41, 2007. NASA SP-2007-4541.
- Peebles, Curtis. *The Spoken Word: Recollections of Dryden History Beyond the Sky*. Monographs in Aerospace History, No. 42, 2011. NASA SP-2011-4542.
- Dick, Steven J., Stephen J. Garber, and Jane H. Odom. *Research in NASA History*. Monographs in Aerospace History, No. 43, 2009. NASA SP-2009-4543.
- Merlin, Peter W. *Ikhana: Unmanned Aircraft System Western States Fire Missions*. Monographs in Aerospace History, No. 44, 2009. NASA SP-2009-4544.
- Fisher, Steven C., and Shamim A. Rahman. *Remembering the Giants: Apollo Rocket Propulsion Development*. Monographs in Aerospace History, No. 45, 2009. NASA SP-2009-4545.
- Gelzer, Christian. *Fairing Well: From Shoebox to Bat Truck and Beyond, Aerodynamic Truck Research at NASA's Dryden Flight Research Center*. Monographs in Aerospace History, No. 46, 2011. NASA SP-2011-4546.
- Renee M. Rottner. *Making the Invisible Visible: A History of the Spitzer Infrared Telescope Facility (1971–2003)*. Monographs in Aerospace History, No. 47, 2017. NASA SP-2017-4547.
- Arrighi, Robert. *Pursuit of Power: NASA's Propulsion Systems Laboratory No. 1 and 2*. Monographs in Aerospace History, No. 48, 2012. NASA SP-2012-4548.
- Goodrich, Malinda K., Alice R. Buchalter, and Patrick M. Miller, comps. *Toward a History of the Space Shuttle: An Annotated Bibliography, Part 2 (1992–2011)*. Monographs in Aerospace History, No. 49, 2012. NASA SP-2012-4549.

- Ta, Julie B., and Robert C. Treviño. *Walking to Olympus: An EVA Chronology, 1997–2011*, Vol. 2. Monographs in Aerospace History, No. 50, 2016. NASA SP-2016-4550.
- Gelzer, Christian. *The Spoken Word III: Recollections of Dryden History; The Shuttle Years*. Monographs in Aerospace History, No. 52, 2013. NASA SP-2013-4552.
- Ross, James C. *NASA Photo One*. Monographs in Aerospace History, No. 53, 2013. NASA SP-2013-4553.
- Launius, Roger D. *Historical Analogs for the Stimulation of Space Commerce*. Monographs in Aerospace History, No. 54, 2014. NASA SP-2014-4554.
- Buchalter, Alice R., and Patrick M. Miller, comps. *The National Advisory Committee for Aeronautics: An Annotated Bibliography*. Monographs in Aerospace History, No. 55, 2014. NASA SP-2014-4555.
- Chambers, Joseph R., and Mark A. Chambers. *Emblems of Exploration: Logos of the NACA and NASA*. Monographs in Aerospace History, No. 56, 2015. NASA SP-2015-4556.
- Alexander, Joseph K. *Science Advice to NASA: Conflict, Consensus, Partnership, Leadership*. Monographs in Aerospace History, No. 57, 2017. NASA SP-2017-4557.

ELECTRONIC MEDIA, NASA SP-4600

- Remembering Apollo 11: The 30th Anniversary Data Archive CD-ROM*. NASA SP-4601, 1999.
- Remembering Apollo 11: The 35th Anniversary Data Archive CD-ROM*. NASA SP-2004-4601, 2004. This is an update of the 1999 edition.
- The Mission Transcript Collection: U.S. Human Spaceflight Missions from Mercury Redstone 3 to Apollo 17*. NASA SP-2000-4602, 2001.
- Shuttle-Mir: The United States and Russia Share History's Highest Stage*. NASA SP-2001-4603, 2002.
- U.S. Centennial of Flight Commission Presents Born of Dreams—Inspired by Freedom*. NASA SP-2004-4604, 2004.
- Of Ashes and Atoms: A Documentary on the NASA Plum Brook Reactor Facility*. NASA SP-2005-4605, 2005.
- Taming Liquid Hydrogen: The Centaur Upper Stage Rocket Interactive CD-ROM*. NASA SP-2004-4606, 2004.
- Fueling Space Exploration: The History of NASA's Rocket Engine Test Facility DVD*. NASA SP-2005-4607, 2005.
- Altitude Wind Tunnel at NASA Glenn Research Center: An Interactive History CD-ROM*. NASA SP-2008-4608, 2008.

A Tunnel Through Time: The History of NASA's Altitude Wind Tunnel. NASA SP-2010-4609, 2010.

CONFERENCE PROCEEDINGS, NASA SP-4700

Dick, Steven J., and Keith Cowing, eds. *Risk and Exploration: Earth, Sea and the Stars.* NASA SP-2005-4701, 2005.

Dick, Steven J., and Roger D. Launius. *Critical Issues in the History of Spaceflight.* NASA SP-2006-4702, 2006.

Dick, Steven J., ed. *Remembering the Space Age: Proceedings of the 50th Anniversary Conference.* NASA SP-2008-4703, 2008.

Dick, Steven J., ed. *NASA's First 50 Years: Historical Perspectives.* NASA SP-2010-4704, 2010.

SOCIETAL IMPACT, NASA SP-4800

Dick, Steven J., and Roger D. Launius. *Societal Impact of Spaceflight.* NASA SP-2007-4801, 2007.

Dick, Steven J., and Mark L. Lupisella. *Cosmos and Culture: Cultural Evolution in a Cosmic Context.* NASA SP-2009-4802, 2009.

Dick, Steven J. *Historical Studies in the Societal Impact of Spaceflight.* NASA SP-2015-4803, 2015.



INDEX

▲ Hubble's ACS produced this image of the Whirlpool Galaxy (M51) in 2005. (NASA/ESA/S. Beckwith [STScI]/The Hubble Heritage Team [STScI/AURA]: heic0506a)

Page numbers in **bold** indicate pages with images.

A reference to an endnote is indicated with an “n” after an entry's page number.

60 Minutes, 131

A

Adams, Ansel, 134

Advanced Research Projects Agency
(ARPA), 127

Advanced X-ray Astrophysics Observatory
(AXAF), 40–41

Aerospace Corporation, 226

Ahmed, Mansoor, 272

Air Force, U.S., 21

Allen, Lew, 79

Edwards Air Force Base, 6, 150, 158, 238

launch facilities, 14

Space Shuttle, 21

Akers, Thomas D., 98–99, 103–106, **104**,
106

Albrecht, Rudolf, 48n31, 254

Allen, Joseph P., 99

Allen, Lew, 79, **79**

Altman, Scott D., 159, **163**, 232, 235, **237**

American Astronomical Society (AAS), 15,
108–109, 120, 191–220, 290, 320n7

women, 306–307, 325n58

Anderson, Michael P., **215**

Angel, Roger, 111n5

Anglo-Australian Observatory, 136n7,
137n12, 260

Apollo program, 14–17, 36–37, 46n18,
50n52, 51n67, 98, 117, 130

Arcand, Kimberley Kowal, 133

Ares program, 233–234, 247n80

Army, U.S., 10, 12, 89

rocket team, 14

Signal Corps, 255

Army Air Forces, U.S., 12

artificial satellites. *See* satellites

Associated Universities, Inc., 37, 289

Association of Universities for Research
in Astronomy (AURA), 37–39, 209,
252, 256, 266–267, 274–276, 289

Gemini telescopes, 280n15

rivalries, 153, 274–275

Sembach, Ken, 309

women, 306–308

Astronomical League, 300, 323n40

astronomy, 1–2, 15, 191, 277, 287–288,
316–319, 320n8

Apollo program, 16–17

astronomers, professional, **290**

changes in, 316–319, 335–340

Cold War, the, 21

data, 317–319

data archive, 287–288

digital images, 120–121, 310–311

Giacconi, Riccardo, 38–40, 318

Hubble Space Telescope (HST), 2–3, 6,
82, 85, 133, 202, 291, 316–319,
335–340

unique investigations, **296**

images, 124

infrared, 144–145, 210

- internet, the, 317
 - light (electromagnetic radiation), 338–339
 - minorities, 325n58
 - NASA, 16–18, 219
 - Newton, Isaac, 10
 - Near Infrared Camera and Multi-Object Spectrometer (NICMOS), 315
 - photography, 10, 136n7
 - radio, 121
 - ultraviolet, 144
 - unique investigators, **296**
 - women, 287, 305–308, 325n58
 - x-ray, 38, 179
 - Astrophysical Journal, The*, 317
 - Atacama Large Millimeter/submillimeter Array, 134
 - Australia, 136n7, 179, 182, 259–260
 - Australian National Observatory, 179
 - Ayres, Thomas, 299–300, 315
- B**
- Baade, Walter, 181
 - Back to the Future*, 73n17
 - Bahcall, John N., 2, **18**, 87, 210, 217
 - Grunsfeld, John M., 220–221
 - Hubble Space Telescope (HST)
 - images, 125–126
 - infrared capabilities, 144
 - long exposures, 189–192
 - SM4, 223–224
 - SM5, 218–219
 - spherical aberration, 67, 103
 - James Webb Space Telescope, 217
 - Large Space Telescope (LST), 17–18
 - Spitzer Space Telescope, 210
 - Bahcall, Neta A., 293–294
 - Ball Aerospace, 57, 83, 146, 167, 211–213, **232–233**
 - Advanced Camera for Surveys (ACS), 132, 146, 155, 159–160
 - Cosmic Origins Spectrograph (COS), 167, 212, 232–234
 - Faint Object Spectrograph (FOS), 23, 55–57
 - COSTAR (Corrective Optics Space Telescope Axial Replacement), 85–88, 94–97
 - Goddard High Resolution Spectrograph (GHRS), 57–58, 212
 - James Webb Space Telescope (JWST), 211
 - Near-Infrared Camera and Multi-Imaging Spectrometer (NICMOS), 184
 - Space Telescope Imaging Spectrograph (STIS), 150
 - Wide Field Camera 3 (WFC3), 213, 228
 - balloons, 12, 15, 100
 - Basedow, Bob, 66
 - Beckers, Jacques, 83
 - Beckwith, Steven, 193, 221–224, **223**, 229, 274–275, 278n2
 - women, 308
 - Bedke, John, 129
 - Beggs, James M., 70
 - Behnken, Robert L., 247n82
 - Bell Laboratories, 121, 226
 - Bely, Pierre-Yves, 83
 - Black, David C., 216
 - Bless, Robert C., 22, 34, 68, 85
 - Block, Herbert L. (Herblock), 77
 - Boe, Eric A., 235
 - Boeing, 19
 - Boggess, Albert, 62, 82, 291
 - Bolden, Jr., Charles F., **vii**, **4**, 5
 - Bond, Christopher, 224
 - Bond, Howard, 130
 - Bonestell, Chesley, 134
 - Bottema, Murk, 83–84, 94
 - Bowen, Stephen G., 235
 - Bowersox, Kenneth D., 99, 103–106, **104**, **148**, 149–152
 - Brandt, John C., 22, 58
 - Brinkley, Randy, 99, 109
 - British Aerospace, 61, 91, 162
 - Broome, Doug, 68, 75n37
 - Brown, Curtis L., Jr., **154**, 156, **157**, 170n24
 - Brown, David M., **215**
 - Brown, Emmett, 73n17
 - Brown, George E., 107
 - Brown, Robert A., 83–84, 240n1
 - Burch, Preston, 225, 268–272, **269**
 - Burleson, Winslow, **301**
 - Burrows, Christopher, 64–67, 73n17, 80, 83, 252
 - AGK+81°266 Hubble image, 107–108
 - Hubble Space Telescope (HST) Strategy Panel, 83
 - Bush, George H. W., 70, 92, 98–99, 113n34, 214, 282n47

- Bush, George W., 214–215, 220–222, 225–230, **227**
 Vision for Space Exploration, 227, 334
 Butler, Paul, 201
- C**
- Campbell, John H., 156, 268, **268**, 270
 Canada, 60, 91, 112n28, 115n59, 131, 203n9, 211, 225, 227
 Canada-France-Hawaii Telescope, 131, 203n9
 Canadian Space Agency (CSA), 211, 225, 254
Canadian Spacewalkers: Hadfield, MacLean and Williams Remember the Ultimate High Adventure, 112n28
 Cape Canaveral, 14, 41, 69
 Carey, Duane G., 159, **163**
 Carnegie, Andrew, 288
 Carnegie Observatories, 129, 179, 210
 Carpenter, Ken, 175, 187–188, **188**, 321n24, 340
 Carr, Frank, 39, 257
 Carter, Jimmy, 19
 Cassegrain, Laurent, 9
 Cepollina, Frank J., 90–91, **91**, 256
 Hubble Space Telescope (HST)
 efficiencies, 268
 fixes, 95, 154, 167
 robotic mission, 225, 230
 SM4, 234
 Cerro Tololo Inter-American Observatory, 131, 182, 203n9, 267
 Chaisson, Eric J., 62, 70, 72n14, 72n15
 astronomers, amateur, 302
 Hubble Space Telescope (HST) images, 125–126
Hubble Wars, The, 73n21, 126, 137n18, 138n20
 Chandra X-Ray Observatory, **40**, 41, 134, 156, 193, 195, 297, 304, 329
 Chandra X-ray Center, 318
 Small Magellanic Cloud, **9**
 Chandrasekhar, Subrahmanyan, 41
 Chawla, Kalpana, **215**
 Cheng, Edward, 167, 213
 Chile, 63, 134–135, 179, 182, 267, 289, 318
 Christian, Carol, 130
 Clark, Laurel B., **215**
- Clervoy, Jean-Francois, 156–159, **157**, 252
 Clinton, William J., 98, 102, 107, 282n46, 282n47, 334
 CNN (Cable News Network), 118
 Code, Arthur D., 38
 Cold War, the, 13–14, 16, 20, 44, 267, 288
 Cole, Stephen, 298–299
 Comet Shoemaker-Levy 9, 93, 117–118, **118**, 120, 127–128, 136n2, 195–196, 299
 Compton, Arthur Holly, 41, 88
 Compton Gamma Ray Observatory, **40**, 41, 270
 Computer Sciences Corporation, 273, 306
 Congress, U.S., 98, 282n47
 Advanced X-ray Astrophysics Observatory (AXAF), 41
 astronomers, amateur, 300
 Atlantis crew testimony, 238
 Great Observatories program, 41
 House Subcommittee on Space Science and Applications, 39
 Hubble Space Telescope (HST)
 funding, 249–251
 SM4, 223–231
 SM5, 216–217
 spherical aberration, 70–71
 successes, 86, 107
 support, 267–268, 340
 infrared observing capabilities, 41
 International Space Station, 98, 102
 Large Space Telescope (LST), 17–19, 23, 26
 NASA budgets, 26–27, 32, 92
 NASA space station, 268
 Senate Committee on Appropriations, 81
 Space Exploration Initiative, 70
 Space Shuttle program, 332
Contact, 135
 Copernicus, 15, 291
 Corning Glass, 11, 26
 Cos-B observatory, 179
 Covey, Richard O., 99, 103–106, **104**
 COVID-19 pandemic, 272
 Cox, Nancy, **301**
 Crabb, William “Bill,” G., 73n22, 75n37
 Crocker, James, 83–85, **85**, 94
 Crouse, Patrick, 272–273, **276**, 277
 Curbeam, Robert, 341n8
 Currie, Nancy J., 159, **163**, 164

D

- Dalcanton, Julianne J., 191, 316
 Danly, Laura, 307
 Davidsen, Arthur F., 240n1
 Davis, Bob, 3
 Department of Defense, 214
 ARPANET, 127
 National Aeronautics and Space Administration (NASA), 20
 Perkin-Elmer Corporation, 27–28
 Space Shuttle, 32
 spacecraft, 36
 Strategic Defense Initiative (SDI), 21, 230
 Department of Energy, 3
 Department of Justice, 81
 Dick, Steven J., 222, 244n44
 Dickinson, Mark, 189
 Digital Equipment Corporation (DEC), 257
 Dordain, Jean-Jacques, 279n10
 Dornier GmbH
 Dornier Museum, 25, 332
 Faint Object Camera (FOC), **24**
 Doxsey, Rodger, 65, 83, 260, 276
 Dressler, Alan, 209–210, 242n24
 Dressler report, 211–213
 Dunbar, Brian, 128
 Dunham, David W., 323n40
 Dunham, Larry, 271
 Duque, Pedro, **154**, 170n24
- E**
- Earth, 134, 136, 140, 152, 190, 255
 atmosphere, 12–14, 40, 58, 121, 144, 175, 179, 195–196
 Hubble Space Telescope (HST)
 images, 20, 63, 65–66, 120–121, 176
 infrastructure, 249
 mirror (main), 2
 orbit, 56, 60–61, 175, 258, 269, 298
 preparations, 42, 44, 155
 repairs, 32, 34, 78–79, 82, 88, 105
 magnetic field, 14
 as observing obstacle, 11–14, 40, 128, 144, 191, 332–333
 orbit, 41
 telescope, largest/powerful, 10, 199, 290
 Eastman Kodak, 19, 26, 30
 Edberg, Stephen J., 302–303, 323n40
 Edwin P. Hubble Space Telescope. *See* Hubble Space Telescope (HST)
 Eichenlaub, Jesse E., 323n40
 Einstein, Albert, 184, 187, 298, 339
 Einstein X-ray Observatory, 124–125, 137n9, 137n15, 291
 astronomers, amateur, 300
 Ellis, George, 323n40
 Ellis, Richard S., 240n1
 England, 9, 100
 English, Jayanne, 130
 Europe
 communism, 21, 44
 European Space Research Organization, 22
 Hubble Space Telescope (HST) solar arrays, 44
 space travel, 11
 European Southern Observatory (ESO), 83, 252, **253**, 267, 293
 European Space Agency (ESA)
 Advanced Camera for Surveys (ACS), 159
 astronauts, 99, 252
 astronomers, 252–253
 astronomy, 277
 budget cuts, 253–254
 Burrows, Christopher, 64
 Duque, Pedro, **154**, 170n24
 European Space Astronomy Centre (ESAC), 59–60, 254
 Faint Object Camera (FOC), 23–25, **24**, 65–66, 83, 85, 108–110, 123, 126, 252–254
 displayed, 332
 Herschel Space Observatory, 120
 Hubble Space Telescope (HST), 1, 251–254, 277, 338
 data, 59–60
 data archive, 311
 European Coordinating Facility, 59, 83
 Hubble Space Telescope (HST) Faint Object Camera (FOC), 57
 images, 131
 Independent Optical Review Panel, 80
 SM4 cancellation, 279n10
 solar arrays, 61, 91
 Strategy Panel, 84
 Huygens probe, 198
 James Webb Space Telescope (JWST), 211

- Large Space Telescope (LST), 22–23
 Niccollier, Claude, 99, 155
 Planck spacecraft, 186
 robotic spacecraft, 341n7
 Space Telescope, 251–252
 Space Telescope European Coordinating Facility (ST-ECF), 59, 83–84, 252, **253**, 279n10, 311
 Space Telescope Science Institute (STScI), 64
 spacetelescope.org, 128
 staff, 279n7
 Wide Field Camera 3 (WFC3), 213
 extravehicular activities (EVAs), 5, 42, 54, 155
 astronauts, **104**, **106**, **148**
 difficulties of, 88–89, 99–100
 equipment, 96, 100
 Gemini program, 88
 history of, 112n28
 Lockheed Missiles and Space Company, 89–90
 NASA confidence in, 152–153
 problems, 97–98, 235–236
 simulated, 99–100, 149–150
 three-person, 97
 untethered, 7n11, 88
 women, 4–5, 7n11, 42–44, 88–90, 112n28, 164. *See also* individual astronaut names
- Extreme Ultraviolet Explorer, 312–313
- F**
- Faber, Sandra M., 64–67, **66**, 73n17, 73n18, 73n21, 73n23, 138n22, 315
 astronomy, changes in, 317
 Hubble Space Telescope (HST) observing power, 239
 Hubble Space Telescope (HST) Strategy Panel, 83
- Far Ultraviolet Spectroscopic Explorer mission, 276
- Fastie, Bill, 49n44
- Ferguson, Christopher J., 235
- Ferrarese, Laura, 181
- Ferris, Timothy, 6
- Feustel, Andrew J., 232, 235–238, 236, **237**
- Field, George B., 41
- Fisk, Lennard A., 2–3, 62–63, 79
- Hubble Space Telescope (HST) spherical aberration, 67–69, 72n15, 81
 NASA budgets, 95, 114n38
- Fitts, Richard, 99
- Flanagan, Kathryn, 309, **309**
- Fletcher, James C., Large Space Telescope (LST), 18
- Foale, Michael C., 155, **157**, 158
- Ford, Gerald R., 18–19
- Ford, Holland C., 83, 94, 160, 300
- Foreman, Michael J., 247n82
- France, 9, 131, 201, 253
 Faint Object Camera (FOC), **24**
- Fratarre, Lisa, 130
- Freedman, Wendy L., 179, 186–187, 203n9, 240n1, 340
- Friedman, Thomas L., 318
- Frosch, Robert A., 23–24, 37
- G**
- GaBany, Jay, 316
- galaxies, 10, 13, 87, 126, 130–131, 176–178, 194–195, 304
 Abell 370, **194**
 Abell 2218, 159
 Andromeda, **1**, 135, 177–180, 195, 203n6, 316
 black holes, 153, 188
 Bullet Cluster, 187
 clusters, **194**, 238, 294, 329
 cores, 25
 distances to, 178–181, 186
 early formation, 188
 Faint Object Camera (FOC), 160
 Hubble Deep Field (HDF), 93, 120, 127, 188–191, **190**
 Hubble Ultra Deep Field (HUDF), 192–193
 hydrogen clouds, 153
 Infrared Astronomical Satellite, 144
 intergalactic medium, 304, 329
 Large Magellanic Cloud, 86, **108**, 186, 200, 315
 Milky Way galaxy, the, 10, 177–178, 195
 M16, **337**
 M31 (Andromeda), **1**, 135, 177–180, 195, 203n6, 316
 M81, 179
 M87, 117
 M100, **107**, 109

- M106, 316
 NGC 188, 65
 NGC 346, **359**
 NGC 2014, **361**
 NGC 2020, **361**
 NGC 2174, **vii**
 NGC 2264, **329**
 NGC 2392, 159, 200
 NGC 3372, **343**
 NGC 3532, 62–63, **33**
 NGC 3717, **381**
 NGC 5033, **175**
 NGC 6302, **209**
 NGC 7635, **xi**, **122**
 nuclei, 294
 redshifted, 177–178, **180**, 191–192, 210
 Seyfert, 130
 Small Magellanic Cloud, **9**, 177
 UGC 1810 galaxy, **1**
 Whirlpool galaxy, 117, **403**
 Galaxy Zoo, 316
 Galileo (Galileo Galilei), 2–3, 9, 45n2
 telescope, 176, 338, 342n16
 telescope replica, **330**
 Galileo spacecraft, 98, 196–197
 Gehman, Harold, 224
 Geithner, Paul, 94
 Gemini Observatory, 131, 275
 Gemini program, 51n67, 88, 99
 Gemini telescopes, 275, 280n15, 315, 318
 Gendler, Robert, 316
 General Electric, 11
 Germany, 12, 59, 252–253, 274, 311, 332
 Dornier, 24
 Dornier Museum, 25
 Faint Object Camera (FOC), **24**
 Hubble Space Telescope (HST)
 European Coordinating Facility, 59
 Hubble Space Telescope (HST) Strategy
 Panel, 84
 Large Space Telescope (LST), 23
 Giacconi, Riccardo, 38–40, 74n29, 83, 86,
 124–125, 258–259, **258**, 266–267,
 301
 astronomers, amateur, 300–302
 Hubble Space Telescope (HST) data,
 311–312, 318
 Space Telescope Science Institute
 (STScI) director, **301**
 Glenn, Jr., John H., 154, **154**, 170n24
 Goddard, Robert H., 11–12, 17
 Goddard Space Flight Center (GSFC), 14,
 16, 60–61, 269
 African Americans, 310
 astronomers, 37
 Ball Aerospace, 94
 bias at, 309–310
 Boggess, Al, 62
 budget cuts, 102
 Cepollina, Frank J., 90, 256
 COSTAR (Corrective Optics Space
 Telescope Axial Replacement), 87
 Data Archive and Distribution Service
 (DADS), 311
 data path, 58–60, **60**, 63
 Explorer 6, 94
 High Fidelity Mechanical Simulator, 100
 High Resolution Spectrograph, 86, 91
 history of, 254–257
 Hubble Space Telescope (HST), 36,
 53–54, 58, 90
 data, 59–60, 115n59
 efficiencies, 269–270
 fixes, 110
 Independent Optical Review Panel, 80
 infrared capabilities, 143–147
 lifetime, 330–331
 observing cycles, 258
 Payload Operations Control Center
 (POCC), 264
 replacement camera (WFPC2), 79
 robotic mission, 225
 Science Instrument Command and
 Data Handling system, 234
 SM3A and 3B, 256
 solar arrays, 91, 164
 spherical aberration, 66–68, 77, 79,
 126–127
 Independent Optical Review Panel, 87
 Kimble, Randy, 317
 Large Space Telescope (LST), 17,
 22–24, 37
 LGBT staff, 310
 NASA communications network center,
 59
 National Space Science Data Center,
 310–311
 Near Infrared Camera and Multi-Object
 Spectrometer (NICMOS) repair,
 167

- partnerships, 64, 94, 265–266, 274
 Reverse Brayton Cycle Cryocooler, 153
 rivalries, 73n23, 274–275
 roles and responsibilities, 24, 37, 81, 87,
 254–257, 258, 262
 Satellite Servicing Projects Division, 334
 Satellite Servicing Team, 278n4
 satellites servicing, 90
 Servicing Mission 1 (SM1), 100–101
 Servicing Mission Operations Room, 263
 simulators, 95
 Solar Maximum, 89
 Space Telescope, 39
 Space Telescope Imaging Spectrograph
 (STIS), 145–147
 Space Telescope Operations Control
 Center (STOCC), 5, 59, 256–257,
257, 260, 262–266, **265**, 270–
 271, **271**, 273–274
 Space Telescope Science Institute
 (STScI), 37–38, 54, 64–66
 STAR (Space Telescope Axial
 Replacement), 84–85
 Tracking and Data Relay Satellites
 (TDRS), 256
 Vehicle Electrical Systems Test (VEST)
 Facility, 95, 114n40, **263**, 264
 Vision 2000, 251, 268–270, 273, 312
 Wide Field Camera 3 (WFC3), 213, **228**
 Wide Field/Planetary Camera 2
 (WFPC2), 87, 213
 Goldin, Dan, 98–99, **99**, 102, 109, 167,
 214, 267–268
 Good, Michael T., 232, 235–238, **237**
 Gore, Al, 70, 107
 Gorie, Dominic L., 247n82
 Great Observatories Origin Deep Survey
 (GOODS), 195
 Great Observatories program, 40–41, **40**,
 51n65, 134, 168, 195
 Green, James C., 212, 232
 Green, Richard F., 240n1
 Griffin, Michael D., 222, 230–234, **230**,
 238, 246n72, 254, 340
 Groth, Edward, 83
 Grumman, 20, 211
 Grunsfeld, John M., 155, **157**, 158–159,
163, 164–166, **218**, **237**, 333
 Hubble Space Telescope (HST), signifi-
 cance of, 238
 Hubble Space Telescope (HST) SM4,
 218, 220–222, 230, 232, 234–238
 Gulf War, the, 87
 Gunn, James E., 71, 74n36
- H**
 Hale, George Ellery, 288
 Hale Telescope, 11, 34, 45n7, 121, 123,
 202, 290
 Haley's Comet, 252
 Hall, Donald, 145
 Hammel, Heidi, 196
Handprints on Hubble, 341n8
 Harbaugh, Gregory J., 102–103, **148**,
 149–152
 Harms, Richard, 22, 56
Hartford Courant, 26
 Harvard College Observatory, 177
 Hauser, Michael G., 240n1
 Hawley, Steven A., **4**, **5**, **148**, 149–152
 Heap, Sara (Sally), 58, 86
 Hefflin, J. Milton, 99, 109
 Heinrichs, Allison M., 133
 Herschel Space Observatory, 120, 195
 Hester, Jeff, 116n71, 118–120, 130
 High Energy Astrophysical Observatories
 (HEAO), 179
 Hinners, Noel W., 37, 39
 Hitler, Adolf, 12
 Hoeppe, Göt, 317
 Hoffman, Jeffrey A., 99, 103–106, **104**
 Hollings, Ernest, 98
 Holtzman, Jon, 65–67
Home Improvement, 107
 Hooker reflector telescope, 10, 178–179
 Hornig, Donald F., 37
 Horowitz, Scott J., **148**, 149, 151–152
 Hricko, Karl, **301**
Hubble, 135, 141n56
 Hubble, Edwin P., 9–11, 177–179, **178**, 288
 Hubble constant, 179–180, 186–187, 329
 Hubble Space Telescope (HST), 1–3, **3**,
 10–11, **40**, **60**, 81, **104**, 154, **163**,
166, 191, **237**, 304, 335–340
 30 Doradus, 86–87
 Abell 370 galaxy cluster, **194**
 Abell 2218 galaxy, 159
 accuracy, 2, 55–56, 69, 80, 176–177,
 186, 258
 activated, 53, 262–264

- Advanced Camera for Surveys (ACS),
132–133, 155, 159–161, 165–166,
192–195, 199, 212, 316
- Abell 370 image, **194**
- Cone Nebula image, **329**
details, **160–161, 168**
field of view, **331**
- Hubble Deep Field image, **192**
- NGC 346, **359**
- observable wavelengths, **336**
- Orion Nebula image, **v**
repair, 233–234, 236–239
service interruption, 330
- Westerlund 2 cluster image, **249**
- Whirlpool galaxy, **403**
- AGK+81°266 Hubble image, 107–108
- Allen Committee (Optical Systems
Board), 79–80, 87
- Allen Committee Report, **28**
- Allen Report, **28**
- Amateur Astronomers Working Group,
300–303
- anniversary, 114n38, 120, 159, 175, 183,
239, 337
- Arrokoth, 199, 206n47
- asteroids, 199
- astronauts, 32, 78, 91–107, 96–98, **104,**
106
- astronauts (EVA), 5, 42–43, 54, 88, **100,**
148
- astronomers, 39, 43, 62, 64–65, 69,
71, 82, 86, 175–177, 276–277,
292–304, 329, 335–336
amateur, 300–303, **301**, 316, 323n40
responses to, 316–319
- astronomy, 287–288, 291, 316–319,
335–340
- astronomy, bias in, 305–310
- Atlantis Space Shuttle, 42
- axial instruments, 82–85
- Bahcall, John N., **18**
- Barbara A. Mikulski Archive for Space
Telescopes (MAST), 313, 317
- Big Science, 287–288
- black holes, 304, 329
- budget, 91–92, 95, 113n34
- budget cuts, 32, 267–268
- Bug/Butterfly Nebula, 135, **209, 238**
- Carina Nebula, 229
- Challenger, loss of, 67, 278n1
- Chandra X-Ray Observatory, 329
- Charge-Coupled Devices (CCD) detectors,
123–124, 136, 147, 273, 284n62
- Cold War, the, 20–21
- Comet Shoemaker-Levy 9, 117–118, **118,**
120, 127–128, 136n2, 195–196
- comets, 199–200
- commissioning, 17, 62–63, 87, 124
- computer, 91, 102, 105, 154–156,
264–265, 269, 273–274
- Cone Nebula, **329**
- configuration, 54, **55**
- construction, 26, **33, 87**
- controlled reentry, 330–331
- Cosmic Origins Spectrograph (COS),
218, 226, 232–234, 236–238
details, **168, 232–233**
field of view, **331**
installation, 341n5
observable wavelengths, **336**
- COSTAR (Corrective Optics Space
Telescope Axial Replacement),
25, 69, 85–87, 94–98, 105–108,
106, 107, 116n71, 116n72, 127,
145–146, 150–151
details, **96–97**
displayed, 331
image, **108**
obsolescence, 167
replacement, 212, 232, 236
- costs, 2–3, 32, 36, 43, 91–94, 101–102,
249, 251, 278n1
- criticism of, 3, 39, **77, 98, 133, 135**
- data, 85–86, 130, 134, 297, 300, 304,
310–319
- data, availability of, 335, 335–340
- data, published papers on, **314, 337**
- data archive, 252–254, 262, 287–288,
300, 310–317, 326n71, 332, 338
- Data Archive and Distribution Service
(DADS), 311–312
- Data Interface Unit, 152
- data path, 58–60, **60, 262, 300**
- data quality, 146–147, 179
- delays, 31, 36, 43–44, 62, 89, 91, 156,
233–234, 260, 295
- Department of Defense, 20
- deployment, **3, 5–6, 9, 17, 44, 53,**
60–62, **60, 84, 88–90, 114n50,**
163, 256, 262

- described, 249
- design, **33**, **55**
- development, 13, 15, 41
- diffraction, 66
- dimensions, 1–2
- Discovery Space Shuttle, 44, 60–62
- Dressler report, the, 209–213
- Eagle Nebula, 116n71, **117**, 118, **119**,
127, 130, 132–134, 135, 139n31,
200, 229, 336–339, **337**
- efficiencies, 268–270, 321n21
- electromagnetic spectrum, 40–41
- Engineering and Science Tape Recorder,
152
- European Space Agency (ESA),
249–251, 251–254
- exoplanets, 201–202, 217, 335
- Faint Object Camera (FOC), 23–25, **24**,
55–57, **55**, 65, 73n21, 83, 85, 95,
102, 108, 116n72, 126–127, 133,
199
details, **168**
displayed, 332
image, **108**, 109–110
replacement, 146, 155, 160, 165–166,
303
- Faint Object Spectrograph (FOS), 55–57,
55, 95, 108–110, 116n72, 145, 151
details, **56–57**, **168**
displayed, 331
replacement, 146, 331
- Fellowships, 298, 306
- Fine Guidance Sensors (FGS), 2, 19, 23,
27, 55–56, 61, 83, 97, 144, 147,
149–158, 264, 273
degradation, 330
details, **30**, 30–31
field of view, **331**
FGS1r, 31, 149, 151
observable wavelengths, **336**
replacement, 147, 155–158, 158
- “First Light,” 62–66, 72n14, 73n21, 79
media release, 62–66, 124–126
- fixes, 5, 32, 34–35, 77, 81–110
- free flight, 6, 53
- Frontier Fields, 193–194
- funding, 249–251, **250**
- future of, 329–332
- galaxies, 117, 126, 130–131, 135, 153, 182,
194, 238, 294, 304, 316, 329, **381**
redshifted, **180**, 210
- Galaxy Zoo, 316
- Giacconi, Riccardo, 38
- Goddard High Resolution Spectrograph
(GHRS), 55–58, **55**, 86, 94–95,
108–110, 116n72, 151, 187
details, **58–59**
failure, 47n30, 91, 106, 296
GTO program, 321n24
replacement, 145, 146, 303, 341n5
- Goddard Space Flight Center (GSFC),
39, 58, 309
- versus ground-based observatories,
298–300
- Guaranteed Time Observers (GTOs),
292, 295–296
- Guide Star Catalog, 252, 258–261, 273,
280n26
- Guide Star Selection System, 39
- gyroscopes, 54–55, 91, 102–103, 103,
105, 155–156, 158, 226, 232–236,
273, 330
- HD96755 star, 63
- Herbig-Haro Jet, **53**
- Heritage Project, 130–131, 133, 135
- High Speed Photometer (HSP), 55–57,
55, 85–86, 86, 105
details, **68–69**
displayed, 332
- Horsehead Nebula, **287**
- Hot Stars project, 316
- HST successor, 210–213
- Hubble constant, 179–180, 186–187,
329
- Hubble Deep Field (HDF), 93, 120,
127–128, 135, 139n31, 188–195,
190, **192**, 267, 269–270, 304,
317, 335, 339
- Hubble Deep Field South, 192
- Hubble Ultra Deep Field (HUDF), 192,
192
- Hubble Wars*, *The*, 73n21
- Hubble-Lemaître law, 178–180
- HubbleSite, 128–129
- image quality, 62, 93–94, 118–120,
135–136
- images, 34–35, 56–57, 65–66, 93,
93–94, 117–120, 124–127, 127,
129–134, 131–132
as art, 133–134, 135

- media release, 124–127
- public release, 128
- imaging (digital), 120–124, 127, 129, 134, 136
- imaging instruments, **168**
- Imaging Michelson Spectrometer (HIMS), 145
- improvements, 43–44
- Independent Optical Review Panel, 80, 87
- infrared observing capabilities, 143–145, **287**
- innovations, 273–274, 289
- instrument replacement, 147, 149–158
- instruments, **168**
 - published papers by, **314**
- intergalactic medium, 304, 329
- International Solar Terrestrial Physics Program, 114n38
- versus International Ultraviolet Explorer (IUE), 299–300
- internet, the, 127–129, 136, 139n31, 312
- Io, 302
- iPhones, 129
- James Webb Space Telescope (JWST), 329, 335, 338
- journalists, 63
- Jupiter, **118, 197**
- Key Projects, 176–202, 294, 304
- Keyhole Nebula, **343**
- Large Magellanic Cloud, 86, **108**, 315
- Late Night with David Letterman*, 62, 72n13
- launch, 38, 62, 72n15, 77, 91, 124, 147, 200
 - costs, 278n1
 - schedule, 31, 32, 42–43, 62, 72n15
- legacy, 6, **183**, 332, 335–340
- lifetime, 210–212, 217, 219, 233, 238, 273–274, 277, 288, 329–332, 335–340
- light (electromagnetic radiation) observable wavelengths, **336**
- long exposures, 294
- management, 24–25, 32, 277
- Mars, **196**
- Marshall to Goddard handover, 90
- media responses to, 2–3, 6, 62–63, 67–70, 74n29, 77–79, 102–103, 107–108, 117–120, 124–131, 191, 251, 278n1, 298, 335–340
- Melnick 34, **108**
- milestones, 36, 62
- military programs, 20–21
- mirror (backup), 331–332
- mirror (main), 2, 20, 26–32, **27**, 35, 38, 47n26, 54, **55**, 64–65, 78–84
 - masking, 84
- mirror (secondary), 2, 26–27, 54, **55**, 64–65, 79–80, 84
 - replacement, 84
- mirror defects, **28**, 35, 49n51, 64–71, 72n13, 73n17, 74n29, 77–83, **77**, 91–94, 126, 179–180, 339–340
 - effects, **108**
- mirrors (pickoff), 83
- mission time estimates, 90
- model, **4**
- Moon, the, 199
- moons, 117, 153, 302
- Mountain, Mattias, 275–276
- MU69 (Arrokoth), 199, 206n47
- Multi-Cycle Treasury Programs, 193–195
- Mystic Mountain, 229
- NASA Office of Inspector General, 81
- Near Infrared Camera and Multi-Object Spectrometer (NICMOS), 94, 102, 132, 145–147, 150, 153, 158, 210, 213, 228, 303
 - degradation, 330
 - details, **168, 184–185**
 - discontinued, 239
 - field of view, **331**
 - long exposures, 192–193
 - observable wavelengths, **336**
 - repair, 162, 166
- nebulae, 118–119, 126, 130–131, 200, 229, 315
 - new start, **250**
- NGC 188 star cluster, 65–66, **65**
- NGC 346, **359**
- NGC 2014, **361**
- NGC 2020, **361**
- NGC 2264, **329**
- NGC 2392 Nebula, 159, 200
- NGC 3372, **343**
- NGC 3532 star cluster (“First Light”), 62–63, **63**
- NGC 3717, **381**

- NGC 5033, **175**
 NGC 6302, **209**
 NGC 7635, **xi**, 122
 novae, 302, 315
 observing cycles, 175–176, 258, 269–
 270, 292–299, **296**, 304–306,
 321n21, 322n34
 observing time allocation, 294–304,
 320n14, 329, 335–336
 operations, 270–271
 Operations Project, 255–256
 Optical Control Electronics
 Enhancement Kit, 151–152
 orbit, 60–61, **166**, 214, 223, 232–233,
 258, 269, 295, 298, 321n21,
 332–334
 Orbital Systems Test (HOST) platform,
 154–156, 162, 256
 organization, 283n58
 versus other robotic spacecraft, 143
 Panchromatic Hubble Andromeda
 Treasury (PHAT), 316
 partnerships, 304–305
 “Pillars of Creation” image, 116n71, **117**,
 119–120, **119**, 127, 130, 132–134,
 135, 139n31, 200, 229, 336–339,
337
 planets, 117, **118**, 120, 125, 126, 130,
 151, 195–200, 304
 popularity of, 339–340
 postal stamp, 159
 potential loss of, 275
 Power Control Unit, 90, 164
 power down, 165
 precedents, 11, 15, 40–41, 291
 preparations for deployment, 88–90
 problems, 5, 25–30, **28**, 32, 44, 49n51,
 60–61, 64–71, 65, 77–83, 91,
 102–103, 153–156, 233–234, 260,
 329–330
 quasars, 294
 Reaction Wheel Assembly, 165
 versus reconnaissance satellites, 20
 reflecting telescope, 9
 refurbishing, 32, 34–35
 Remote Manipulator System (RMS),
106, **237**
 replacement camera (WFPC2), 78–79
 Ritchey-Chrétien Cassegrain reflecting
 telescope, 54
 robotic missions, 225–230, 278n2
 robotic orbit boost, 331
 roles and responsibilities, 37, 335
 Roman, Nancy Grace, 309
 Rothenberg, Joseph H., 81–82, **82**
 safe mode, 60–62, 156
 Saturn, **78**, **198**
 Science Instrument Command and Data
 Handling system, 234
 Science Operations Ground System
 (SOGS), 260–261
 Second Decade Committee, 304
 Servicing Mission 1 (SM1), 91, 91–110,
104, 117, 126–127, 149–150,
 164, 209, 264–265, 267–268
 and observing, 296
 simulation, **100**
 Servicing Mission 2 (SM2), 146–155,
148, 162, 302–303
 preparation, **162**
 Servicing Mission 3 (SM3), 155–159
 Servicing Mission 3A (SM3A), 156, 213,
 252, 265
 Servicing Mission 3B (SM3B), 159–167,
 171n31, 209, 213, 220
 Servicing Mission 4 (SM4), 54, 151,
 167, 193, 209–214, 217–240, 271,
 273–275, 275–277, 304, 329–331,
 338
 cancellation, 219–226, 233, 253–254,
 275, 279n10
 costs, 278n2, 278n4
 Galileo’s telescope replica, **330**
 installations, 336
 Servicing Mission 5 (SM5), 216–219,
 218
 servicing missions, 35, 54, 61, 69, 78,
 82–83, 87–90, 143
 costs, 332
 danger of, 214, 229
 end of, 239, 329–330
 halt of, 221–223
 lessons learned, 334
 partnerships, 255–256
 simulated, **100**
 success of, 332
 Servicing Science Working Group, 146
 simulated Hubble, 100
 Small Magellanic Cloud, **9**
 smartphones, 129

- social media, 128–129, 223
- Soft Capture and Rendezvous System, 54
- solar arrays, 8, 38, 48, 53, 61, 64, 86–87, 91, 105–106, 155, 162–165, **166**, 172n42, 264
 - damaged, 150–152
- Solar Blind Channel (SBC), 331, 336
- solar system, the, 195–200
- Space Shuttle, relationship, 332–335
- Space Telescope: A Study of NASA, Science, Technology and Politics*, 13
- Space Telescope Imaging Spectrograph (STIS), 94, 145–147, 153, **162**, 211–212, 303
 - details, **150–151, 168**
 - field of view, **331**
 - observable wavelengths, **336**
 - repair, 236
- Space Telescope Operations Control Center (STOCC), 5, 59, 256–257, **257**, 260, **271**, 273–274
- Space Telescope Science Institute (STScI), 38, 59–60, 62–63, 83
- SpaceCube, 274
- spacewalkers, 5, 42, 54, 88
- spectrographs, 55
- spectroscopy instruments, **168**
- stakeholders, 36
- STAR (Space Telescope Axial Replacement), 84–85, 94
- stars, 117, 134, 151, 153, 200–202, 304
- stellar magnetic fields, 302
- stellar populations, 329
- Strategy Panel, 83–86
- Structural Dynamic Test Vehicle, 100, 331–332
- successes, 18, 78, 86–87, 106–110, 167–169, 175–177, **183**, 202, 239–240, 253, 277, 297, 318, 335–340
- successor, 210–213, 217, 240
- Sun, the, 199
- sunset mission, 210–213, 217–219, 221
- Supernova 1987A, 134, 200–201
- supernovae, 181–183, 315, 335
- Support Systems Module, 36
- testing, 36, 43, 70, 260–261
- Time Allocation Process, 262
- Tracking and Data Relay Satellites (TDRS), **55**, 58–61, **60**, 249
- Treasury programs, 304, 316
- UGC 1810 galaxy, **1**
- Ultima Thule. *See* Arrokoth
- Ultra Deep Field, 167
- ultraviolet capabilities, 40, 133, 144–145, 303, 329, 335
- ultraviolet wavelengths, 21, 86
- unique investigators, **296**
- universe, the, 332
- Ursa Major, 269–270
- website, 316
- Westerlund 2 cluster, **249**
- Wide Field Camera 3 (WFC3), 120, 132–133, 180, 192–200, 232–235, 316
 - Abell 370 image, **194**
 - details, **168, 228–229**
 - Bubble Nebula, **xi**
 - Bug/Butterfly Nebula, 135, **209**, 238
 - developed, 317
 - field of view, **331**
 - Herbig-Haro Jet image, **53**
 - Hubble Deep Field image, **192**
 - installation, 218, 226, 239
 - Jupiter image, **197**
 - NGC 2174, **vii**
 - NGC 6302 (Bug/Butterfly Nebula), **209**
 - observable wavelengths, **336**
 - Saturn image, **198**
 - service interruption, 330
 - UGC 1810 galaxy image, **1**
 - Westerlund 2 cluster image, **249**
- Wide Field/Planetary Camera 2 (WFPC2), **55**, 78–79, 82–83, 85–87, **100**, **104**, 105, 115n62, 132–133, 144–147, 150–151, 189–192, 196
 - building of, 93–95
 - details, **92–93, 168**
 - displayed, 331
 - Eta Carinae image, **389**
 - Herbig-Haro Jet image, **53**
 - images, 109–110, 116n71, 117–120
 - Jupiter image, **118**
 - M100 image, **107**
 - Mars image, **196**
 - Melnick 134 image, **108**
 - NGC 2174, **vii**
 - replacement, 160, 167, 212–213, 232, 341n5
 - team, 116n71

- Wide Field/Planetary Camera (WF/PC),
 34–36, **34**, **35**, 55–57, 63–71,
 73n21, 78–79, 83, 86, 92–94,
104, 105, 126–127
 details, **168**
 M100 image, **107**
 Melnick 34 image, **108**
 team, 64–67, **66**, 71, 87
 women, **307**
 Zooniverse, 316
- Hubble Wars, The*, 126
- Hughes Aircraft Company, 32, 73n22,
 170n13
- Hughes Danbury, 64, 66–67, 72n22, 80–81
 Optical Systems Inc., 80–81, 170n13
- Humason, Milton L., 178
- Husband, Rick D., **215**
- Hussein, Saddam, 87
- Hutchings, John, 315
- Hutchinson, Kay Bailey, 225
- I**
- Infrared Astronomical Satellite, 144, 179
- International Astronomical Union, 179,
 199, 289, 293
- International Solar Polar Mission, 252
- International Space Station, 3, 59, 70, 102,
 107, 341n7. *See also* NASA space
 station
 Columbus module, 341n7
 completion, 221–222
 construction, 98, 47n18, 143, 149, 219,
 231
 costs, 92, 214
 criticism of, 98
 Dextre robot, 227, 245n67
 future of, 334
 Hubble Space Telescope (HST) SM4,
 222–223, 234–235
 maintenance, 227
 orbit, 214, 223
 priority, 219, 334
 problems, 98, 102, 226
 robotic spacecraft servicing, 341n7
 servicing missions, 214, 231
 end of, 239
 Space Shuttle safe haven, 214, 216, 231,
 243n30
 successes, 109
 successor to, 334
- International Ultraviolet Explorer (IUE),
 137n9, 144, 252, 291, **291**, 293,
 297, 312. *See also* NASA Space
 Station
 versus Hubble Space Telescope (HST),
 299–300
 shut down, 320n10
- Isakowitz, Steve, 220
- Israeli Space Agency, 215
- Italy, 38, 83, 260,
- J**
- Jackson and Tull, 114n40
- Jakobsen, Peter, 25
- James Webb Space Telescope (JWST), 167,
 187, 193, 210–212, 274–275, 313,
 315
 artist's conception, **211**
 astronomers, 276–277
 costs, 220
 data, 276
 development, 275–277
 European Space Agency (ESA),
 252–254
 infrared observing capabilities, 335
 partnership with Hubble, 329, 335
 successor to Hubble, 210–212, 217–
 218, 240
 support for, 338
- Japan, 154, 170n24
- Jarvis, Gregory, **42**
- Jeffreys, Bill, 30
- Jeletic, James, 256
- Jenkner, Helmut, 252
- Jet Propulsion Laboratory (JPL), 14, 87, 95
 Allen, Lew, 79
 Hubble Space Telescope (HST) data, 79
 Morabito, Linda, 137n18
 Trauger, John, 78
 Voyager images, 125
 Wide Field/Planetary Camera (WF/PC),
 36, 56–57
- Wide Field/Planetary Camera 2
 (WFPC2), 92–94, 144, 212–213
- Johnson, Gregory C., 232, 235, **237**
 Wide Field/Planetary Camera 2
 (WFPC2) replacement, 235
- Johnson, Gregory H., 247n82
- Johnson, Lyndon B., 37
- Johnson, Stephanie, 305

- Johnson Space Center (JSC), 15, 88–89, 99, 236, 256
 Hubble Space Telescope (HST)
 fixes, 110, 234, 235
 Payload Operations Control Center (POCC), 263–264
 robotic mission, 225
 SM4, 234, 236
 International Space Station, 109, 334
 Manipulator Development Facility, 100
 NASA Space Station, 109
 rivalries, 110
 robotic spacecraft, 225
 Servicing Mission 1 (SM1), 96, 99–101
 Space Operations and Management Office (SOMO), 270
 Weightless Environment Training Facility (WETF), 100, 149–150
- Jones, Charles, 80
- Jupiter, 9, 35, 117, **118**, 125, 136n2, 138n23, 151, 153, 195–199, **197**, 299
 Comet Shoemaker-Levy, 93, 117, **118**, 120, 127
 Europa, 153, 198
 Galileo (Galileo Galilei), 45n2, 98
 Ganymede, 153, 198
 Io, 117, 125, 137n18, 197, 302
 moons, 45n2, 117, 125, 153, 197, 299, 302. *See also* individual moon names
 Space Telescope Imaging Spectrograph (STIS), 151
- K**
- Keck telescope, 315
 Kelly, Scott J., 156, **157**
 Kennedy, John F., 15
 Orbiting Astronomical Observatory-2 (OAO-2), **19**
 Kennedy Space Center (KSC), 1–2, 14, **19**, 43, 62, 103, 106, 150, 152, 231, 256
 Atlantis Space Shuttle, 239
 Columbia Space Shuttle, 167, 209
 Discovery Space Shuttle, 159, 231
 Vertical Processing Facility (VPF), **162**
 Kennicutt, Jr., Robert C., 179, 242n24
 Kessler, Elizabeth A., 124, 133–134
 Keyworth, George A., 39
 Kimble, Randy, 317
 Kimbrough, Robert S., 235
- Kinney, Anne L., 130, 139n 36, 218–219, 309–310
 Kirshner, Robert P., 176, 182, 189, 240n1, 298, 315, 322n34
 Kitt Peak National Observatory, 37, 73n18, 131, 190, 289, 292–294, 299
 Interactive Data Reduction and Analysis Facility, 320n13
 Korsch, Dietrich, 80
 Kuhn, Thomas, 339
 Kuiper Airborne Observatory, 144
 Kuiper Belt, the, 199, 206n47
 Kulkarni, Shrinivas, 83, 240n1
- L**
- Lafreniere, David, 315
 Lambright, W. Henry, 226
 Lanzerotti, Louis J., 226
 Large Space Telescope (LST), 15–44, **21**, 121. *See also* Space Telescope
 approved, 19
 artists' conception, **21**
 astronomers' lobby, 17–19, 22, 120–121
 budget cuts, 17–19
 construction, 19–25
 design, **21**, 22
 funding, 18
 Giacconi, Riccardo, 38
 name change, 18
 reductions, 18
 ultraviolet spectrographs, 22
 Larson, Ana M., 302
 Las Campanas Observatory, 126
 NGC 3532 star cluster, **63**
 Lasker, Barry M., 260
Late Night with David Letterman, 62
 Lauer, Tod, 64, **66**, 73n17, 73n18, 73n23, 87
 Lawrence, George N., 80
 Lawrence Berkeley National Laboratory, 181
 Leavitt, Henrietta Swan, 177, **177**
 Leckrone, David S., 67, 81, 112n19, 144, 146, 167, **236**
 Cosmic Origins Spectrograph (COS), 212–213
 Giacconi, Riccardo, 267
 Hubble Space Telescope (HST) SM4, 235
 Hubble Space Telescope (HST) successes, 318

- Lee, Mark C., **148**, 149, 151–152
- Lemaître, Georges, 178
- Levay, Zoltan, 129–133, **129**, 133, 139n34, 140n39
- Levy, David H., 117, 195
- Lewycky, George, **301**
- Ley, Willy, 134
- Lick Observatory, 64
- light (electromagnetic radiation), 12, 36, 124
 - Advanced Camera for Surveys (ACS), 160–161, 193, 195, 212–213, 229, 239, **336**
 - astronomers, 10, 40–41, 62, 144, 147, 175–181, 198–200, **290**, 319, 329–340
 - astronomers, amateur, 118, 123, 126, 135, 196, 300
 - diffraction, 66
 - diffraction limit, 109, 335
 - electromagnetic spectrum, 10, 13, 40–41, 338
 - Fine Guidance Sensors (FGS), **336**
 - gamma rays, 40–41, 175, 179, 338
 - gravitational lensing, 87, 134, 187, 193, 329
 - gravity waves, 342n17, 338
 - Great Observatories program, 41
 - HD96755 star, 63
 - Hubble Space Telescope (HST)
 - accuracy, 69
 - Faint Object Spectrograph (FOS)
 - details, **56–57**
 - “First Light,” 62–63
 - image quality, 135
 - instruments observable wavelengths, **336**
 - mirror, 35
 - mirror laser, 28–29
 - Hubble versus Las Campanas images, **63**
 - Hubble versus Nordic Optical images, **65**
 - infrared, 40–41, 120, 123, 143–145
 - interference pattern, 28–29
 - Near Infrared Camera and Multi-Object Spectrometer (NICMOS), **336**
 - neutrinos, 338
 - NGC 3532 star cluster, 62–63
 - Ritchey-Chrétien Cassegrain reflecting telescope, 54
 - Space Telescope Imaging Spectrograph (STIS), **336**
 - spectra, 10–13, 62, 86, 116n72, 124, 176, 181, 289, 294
 - stellar magnitude, 23, 30, 258–260
 - ultraviolet, 12, 15, 21, 68–69, 86, 123, 179
 - ultraviolet decontamination, 34
 - ultraviolet Faint Object Camera (FOC), **24, 336**
 - vignetting, 65
 - visible, 11, 24, 40, 56–57, 62, 68, 93, 120, 131–134, 144–145, 151, 160, 187, 193–194, 198, 213, 335–338
 - Wide Field Camera 3 (WFC3), **336**
 - x rays, 40, 124–125, 179, 300, 338
- Lilly, Simon J., 240n1
- Lindsey, Steven W., **154**
- Linnehan, Richard M., 159, **163**, 164–166
- Lintott, Chris, 316
- Litton Itek Optical Systems, 19, 94
- Livio, Mario, 193, 202
- Lockheed Martin, 227, 230, 265–266
 - Consolidated Space Operations Contract (CSOC), 270–271
 - Space Systems, 255–256
- Lockheed Missiles and Space Company, 19–20, 23–26, **33**, 165
 - extravehicular activities (EVAs) rehearsals, 89–90
 - Hubble Space Telescope (HST)
 - construction, **33**, 88
 - data, 115n59
 - servicing missions, 88–89
 - Optical Systems Laboratory, 80
 - Optical Telescope Assembly (OTA), 36
 - partnerships, 64
 - roles and responsibilities, 24
- Logsdon, John, 102–103
- Loral AeroSys, 93, 257, 264–265, 311, 326n70
- Los Angeles Times*, the, 133
- Low, George M., 18
- Lowell Observatory, 199
- Lupie, Olivia, 112n19
- Lynds, Roger, 64–65, 73n17
- M**
- Macchetto, F. Duccio, 23–24, 73n21, 116n72, 252
 - Hubble Space Telescope (HST) SM4 cancellation, 279n10

- MacDonald Dettwiler and Associates, Ltd., 227
- Malin, David, 136n7
- Mangus, John D., 67, 73n23, 80, 111n5
- Marcy, Geoffrey, 201
- Margon, Bruce H., 223, 240n1
- Marines, U.S., 96, 99
- Mars, 35, 102, 176, 195, **196**, 199
space travel, 16, 70, 92, 121, 128
- Mars Observer, 102
- Mars Pathfinder, 128
- Marshall Space Flight Center (MSFC), 14
extravehicular activities (EVAs) rehearsals, 89–90, **100**, 149–150
Hubble Space Telescope (HST), 36, 54
construction, 87, 254
handover to Goddard, 90
Independent Optical Review Panel, 80
servicing missions, 42, 88–89
spherical aberration, 67
Jones, Charles, 80
Large Space Telescope (LST), 17, 24, 37
Neutral Buoyancy Simulator, 100, **100**, 149, 165
partnerships, 64
rivalries, 73n23
roles and responsibilities, 20, 24, 81, 87, 254
- Martin Marietta Corporation, 19, 56–57, 280n14
- Maryland Space Grant Consortium, 306–307
- Massimino, Michael G., 159, **163**, 165–166, 172n43, **237**, 341n8
Hubble Space Telescope (HST) SM4, 232, 235–238, 333
- Mattei, Janet A., 323n40
- Mauna Kea observatory, 131, 134–135, 179
- Mayor, Michel, 201
- McArthur, K. Megan, 232, 235, **237**, 238
- McAuliffe, Sharon Christa, **42**, 43
- McCandless II, Bruce, **4**
EVAs, 5, 7n11, 88–90
Hubble Space Telescope (HST) deployment, 42–44, 90, 164
Hubble Space Telescope (HST) Strategy Panel, 83–84, 90
- McCool, William C., **215**
- McCray, W. Patrick, 288, 290, 316–319
- McCurdy, Howard E., 167
- McDonald, Robert, 112n28
- McLean, Brian J., 260
- McNair, Ronald E., **42**
- Meinel, Aden, 79–80, 100n4
- Meinel, Marjorie, 79–80
- Mercury, 199
- Mercury program, 154
- Merwarth, Ann C., 255, 268
- Messier, Charles, 119
- Mikulski, Barbara A., 81, 98, 109, 224
Archive for Space Telescopes, 313
Hubble Space Telescope (HST) SM4, 221, 224–226, 228, 231, 238–239
Hubble Space Telescope (HST) support, 70, 267–268, 340
- Miley, George K., 242n24
- Milky Way galaxy, the, 10, 177–178, 195
- Miller, William, 121
- Minkowski, Rudolph, 181
- missile programs, 13–14
- Mitterando, Joseph, **301**
- Moon, the, 9, 14, 56, 182, 190–191, 199, 210
Apollo 16, 16
Galileo (Galileo Galilei), 45n2
Moon landing, 14–16, 21, 92, 117, 221
Space Exploration Initiative, 70
space travel, 11, 14, 21, 70, 121
telescope on, 210
- moons, 125, 196–198
Charon, 25, 117, 199
Europa, 153, 198
Galileo (Galileo Galilei), 45n2
Ganymede, 153, 198
Hydra, 199
Io, 117, 125, 137n18, 197, 302
Jupiter's, 45n2, 117, 125, 153, 197, 299, 302
Kerberos, 199
Nix, 199
Pluto's, 25, 117, 160, 199
Prometheus, 198
Saturn, 197–198
Styx, 199
Titan, 198
Uranus's, 198
- Moore, Duncan T., 80
- Moore, James V., 257
- Morabito, Linda, 137n18
- Moran, Thomas, 134

- Mould, Jeremy, 179
- Mount Palomar Observatory, 11–13, 34, 121, 123, 179, 195, 202, 259, 280n26, 288–290, 335
 Guide Star Catalog II, 260
 popularity of, 339
- Mount Stromlo Observatory, 181–182
- Mount Wilson Observatory, 9–11, 13, 121, 178–179, 288, 339
- Mountain, Mattias, 193, 275–276, 308–309, **309**, 317–318
- Mukai, Chiaki, **154**, 170n24
- Muller, Steven P., 38–39
- Musgrave, F. Story, 5, 88, 96–97, 99–100, 103–106, **104**, 333, 341n8
- N**
- Naked Gun 2 1/2: The Smell of Fear*, 70, 135
- Nancy Grace Roman Space Telescope, 20, 187, 313, 315, 326n80. *See also* Wide Field Infrared Survey Telescope (WFIRST)
- NASA Select*, 103, 115n59
- National Academy of Sciences (NAS)
Astronomy and Astrophysics for the 1970s report, 17
 Committee on Data Management and Science, 311
 Hornig committee, 37
 Hubble Space Telescope (HST)
 robotic mission, 225–226
 SM4, 224–225
 successor, 210
 Large Space Telescope (LST), 15–16
 roles and responsibilities, 37, 39, 224
 Space Telescope Science Institute (STScI) report, 39
- National Advisory Committee for Aeronautics (NACA), 14
- National Aeronautics and Space Administration (NASA)
 African Americans, 310, 325n66
 Allen Committee (Optical Systems Board), 79–80
 Apollo program, 14–17, 36–37, 46n18, 51n67, 98, 117, 130
 Association of Universities for Research in Astronomy (AURA), 37–39, 153, 256, 266–267, 274
 astronomers, 37, 319
 amateur, 300–303
 astronomy, 287–289, 297–300
 changes in, 316–317
 bias at, 305–310
 Bolden, Charles F., 5
 budget, human spaceflight, 251
 budget cuts, 18, 26–27, 37, 228, 267–270, 282n47, 283n48
 budgets, 91–92, 95, 101–102, 113n34, 218–221, 229, 249–251, 278n2, 332
 Challenger, loss of, 43–44, 70
 Columbia Accident Investigation Board (CAIB), 216, 218–222, 224–226, 238–239
 Comet Shoemaker-Levy 9, 136n2
 communications network center, 59
 Constellation program, 233
 Cosmic Origins Spectrograph (COS), 167, 212
 COSTAR (Corrective Optics Space Telescope Axial Replacement), 88, 95
 criticism of, 98, 102–103, 107
 Data Archive and Distribution Service (DADS), 311
 delays, 156–158
 Department of Defense, 20
 Dressler report, the, 210–213, 240n1
 Early Release Observation, 127
 established, 14
 European Space Agency (ESA), 22–23
 collaboration, 251–254
 extravehicular activities (EVAs), 97–98
 “faster, better, cheaper” policy, 167
 fellowships, 298, 306
 Gemini program, 51n67, 88, 99
 grants, 297–298
 Great Observatories program, **40**, 134
 Guaranteed Time Observers (GTOs), 292, 295–296
 High Energy Astrophysical Observatories (HEAO), 40
 High Fidelity Mechanical Simulator, 95
 Hispanic Americans, 325n66
 Hornig committee, 37, 39
 Hornig report, 292
 Hubble Space Telescope (HST), 1, 25, 338

- data, 319
- “First Light,” 62–64
- fixes, 108–110
- images, 62, **107**, **108**, 125
- Independent Optical Review Panel, 80
- infrared capabilities, 143–147
- lifetime, 330–331
- mission time estimates, 90
- observing cycles, 287, 305–310
- Optical Systems Board, 79
- Orbital Verification Program, 53–54
- robotic mission, 225–230
- servicing missions, danger of, 229
- SM4, 223–240
- SM4 cancellation, 279n10
- spherical aberration, 66–67, 77, 81, 86, 126
- successes, 107
- Hubble-Shuttle relationship, 32, 43
- human space programs, 16, 268, 332, 334
 - fate of, 334–335
- Inspector General report, 30
- International Space Station, 46n18, 59, 70, 334
- internet, the, 128, 139n31
- iPhones, 139n33
- James Webb Space Telescope (JWST), 210–211
- Large Space Telescope (LST), 15–44, 22, 25
- Launch on Need missions, 156, 171n28
- Lockheed Missiles and Space Company, 23
- management, 44
- media responses to, 69–70, 102–103, 107–108
- Mercury program, 154
- military programs, 20–21
- minorities, 305–310, 325n58, 325n66
- Mission Operations Software and Engineering Support (MOSES), 265–266
- NASA Select*, 103, 115n59
- National Reconnaissance Office, 20
- National Space Science Data Center, 310–311
- Near Infrared Camera and Multi-Object Spectrometer (NICMOS), 145–147
- Neutral Buoyancy Simulator, 149
- Next Generation Space Telescope (NGST), 210
- Office of Inspector General, 81
- Optical Telescope Assembly (OTA), 17, 31
- Orbiting Astronomical Observatory-2 (OAO-2), **19**
- organizational culture, 69–70, 81
- Origins Program, 217
- partnerships, 265–266
- Pellerin, Charles J., 112n20
- Perkin-Elmer Corporation, 23
- personnel, **162**, **257**
- problems, 102
- programs, 15
- Public Affairs Office, 126
- quality control, 27–29, 49n43, 70–71
- rivalries, 274–275
- roles and responsibilities, 24–25, 28–31, 37–38, 37–39, 254, 316
- Senior Review Process, 277
- simulators, 95
- Skylab, 16, 46n18
- smartphones, 139n33
- social media, 129, 139n33
- space observatories, 131
- Space Operations and Management Office (SOMO), 270–271
- Space Shuttle, 16–17, 23
 - costs, 278n4
 - hydrogen leaks, 69
 - program, 332
- space station, 3, 32, 46n18, 268, 334.
 - See also* International Space Station
- Space Telescope, 251–252
- Space Telescope Development Division, 39
- Space Telescope Science Institute (STScI), 37–39, 80, 274, 318
 - policy guidelines, 292–293
 - report, 39
- space telescopes, 15–17
- STS-61 Mission Director’s Post-Mission Report, 109
- Tracking and Data Relay Satellites (TDRS), 59
- unique investigators, **296**
- Vehicle Electrical Systems Test (VEST) Facility, 95
- virtual reality, 95, 100, 149

- Vision 2000, 251, 268–270
 Vision for Space Exploration (Bush),
 220–221, 226–227
 Welch report, 39
 Wide Field/Planetary Camera 2
 (WFPC2), 86, 92
 Wide Field/Planetary Camera (WF/PC),
 36
 Wilkinson Microwave Anisotropy Probe
 (WMAP), 185–186
 women, 305–310, **307**, 325n58
 Y2K concerns, 156–159
 National Air and Space Museum, 35, 57,
 93, 97, 101, 331–332, 341n5
 Structural Dynamic Test Vehicle,
 100–101
National Geographic, 124
 National Geographic Society, 260, 280n26
 National Optical Astronomy Observatories,
 69, 73n18, 280n15, 289, 304
 National Radio Astronomy Observatory, 37,
 289, 292, 304
 National Research Council, 41, 72n9, 210,
 224, 242n29, 297
 National Science Foundation (NSF), 127,
 289, 297
 roles and responsibilities, 37, 316
 National Space Development Agency
 (NASDA), 154
 Navy, U.S., 14, 214
 Naval Research Laboratory, 14, 255
 Nelson, George, 89
 Neptune, 198–200
New Scientist, 70
New York Times, the, 2, 6, 63, 70, 102–103,
 107, 278n1
 Newell, Jr., Homer E., 15
 Newman, James H., 159, **163**, 165–166
Newsweek, 70
 Newton, Isaac, 9–10, 71n3, 339
 Next Generation Space Telescope (NGST),
 210–213, 274
 Nicollier, Claude, 99, 103–106, **104**, 155,
157, 158, 252
 Niedner, Mal, 234
 Nixon, Richard M., 16–17, 332
 Noll, Keith, 130, 139n36, 298
 Nordic Optical Telescope, 65
 Nota, Antonella, 252
Nova, 109, 116n71
- O**
- Obama, Barack, 238, 247n80
 Oberth, Hermann, 11–12, **12**
 observatories, 37, 40–41, 195. *See also*
 telescopes; individual observatory
 and telescope names
 astronomers, 287–292, **290**
 Charge-Coupled Devices (CCD) detec-
 tors, 121–124
 computers, 120–121
 data, 134–135, 318–319
 differences between, 13
 digital images, 288–290
 film-based, 289–290, 310
 ground-based, 319, 336
 ground-based versus Hubble Space
 Telescope (HST), 298–300
 Hawaii, 131, 134–135, 318
 Hubble Heritage, 131, 135
 Hubble Space Telescope (HST)
 images, 78, 135
 precedent, 318–319
 relationship, 335
 image quality, 136n7
 imaging (digital), 135, 137n12
 versus internet, 317
 observing time, 293
 Osservatorio Astronomico di Torino, 260
 photographic plates, 123–124, 310
 redshifted galaxies, **180**
 rise of, 288–289
 Skylab, 16
 space, 144
 STScI's Astronomy Visualization
 Laboratory, 129
 wide field mode, 56
 O'Connell, Robert, 228
 O'Dell, C. Robert, 17, 200
 Oegerle, William R., 242n24
 O'Keefe, Sean, 209, 214–230, **214**,
 238–239, 279n10
 cancellation of SM4, 219–226, 233,
 245n60, 253–254, 275, 340
 Columbia Accident Investigation Board
 (CAIB), 222–226
 Hubble Space Telescope (HST) robotic
 mission, 225–226
 Weiler, Edward J. criticism, 243n43
 Olivier, Jean, 67–68
 Onizuka, Ellison S., **42**

- Optical Telescope Assembly (OTA), 17, 19, 31, 36
- Oracle, 269
- Orbiting Astronomical Observatories (OAO), 15–16, 81, 144, 179, 270
- astronomy, 291
- Cepollina, Frank J., 90
- Grumman, 20
- orbit, 291
- Orbiting Astronomical Observatory-2 (OAO-2), 15, **19**, 121
- Orbiting Astronomical Observatory-3 (OAO-3), 291
- Orbiting Geophysical Observatories, 15
- Orbiting Solar Observatories, 15, 90
- Ortel, Goetz, 306
- Osservatorio Astronomico di Torino, 260
- Overbye, Dennis, 103
- P**
- Page, Norm, 79
- Panoramic Survey Telescope and Rapid Response System (Pan-STARRS), 313
- Parzynski, Scott E., **154**, 170n24
- Paresce, Francesco, 83
- Pellerin, Charles J., 36, 41, 49n51, 51n65, 64, 71, 86
- COSTAR (Corrective Optics Space Telescope Axial Replacement), 86, 112n20
- Hubble Space Telescope (HST) budgets, 293
- Hubble Space Telescope (HST) spherical aberration, 74n29, 75n37
- Wide Field/Planetary Camera 2 (WFPC2), 112n20
- Perkin-Elmer Corporation, 19–20, 23–24, 30, 64, 73n22, 170n13
- budget shortfalls, 26–27
- costs, 23, 30–31
- Fine Guidance Sensors (FGS), 19, 23, 30, 147
- Hubble Space Telescope (HST)
- Fine Guidance Sensors, **30**, 31
- mirror, 26–31
- mirror defects, 30–31, 49n43, 49n44, 81
- microdensitometers, 259
- Optical Telescope Assembly (OTA), 36
- optics fabrication facility, **27**
- partnerships, 64
- quality control, 28–31, 49n43, 49n44
- roles and responsibilities, 24, 27, 254
- sale to Hughes Aircraft Company, 31–32, 170n13
- Perlmutter, Saul, 181–185, **181**
- Persha, Gerald, 323n40
- Peterson, Donald, 88
- Picturing the Cosmos*, 124
- Pioneer spacecraft, 196–198
- planets, 13, 23, 30. *See also* individual planet names; individual planet moons; solar system, the
- Charon (Pluto's moon), 177, 199
- electronic images, 121–122
- Europa (Jupiter's moon), 153, 198
- exoplanets, 201–202, 217, 240n1, 315, 335
- formation, 304
- Ganymede (Jupiter's moon), 153, 198
- Hubble Space Telescope (HST) images, 117, **118**, 120
- Hubble Space Telescope (HST)
- Planetary Camera, 35
- Io (Jupiter's moon), 117, 125, 137n18, 197, 302
- Jupiter, 9, 35, 45n2, 98, 117, **118**, 125, 136n2, 138n23, 151, 153, 195–199, **197**, 299
- Jupiter's moon, moons, 45n2, 117, 125, 153, 197, 299, 302
- Mars, 16, 35, 70, 92, 102, 121, 128, 176, 195, **196**, 199
- Mercury, 199
- Moon, the, 9, 14–16, 21, 45n2, 56, 70, 92, 117, 121, 210, 221, 182, 190–191, 199, 210
- Neptune, 198–200
- Pluto, 25, 87, 117, 160, 199
- Saturn, 11, 35, 69, **78**, 87, 126, 130, 151, 195–200
- Uranus, 122, 151, 198–199
- Venus, 9, 199
- Pluto, 25, 87, 117, 160, 199
- Charon, 177, 199
- Porco, Carolyn C., 240n1
- Postal Service, U.S., 159
- Project RAND, 12–13
- Project to Re-Engineer Space Telescope Observing (PRESTO), 269–270, 312
- Public Broadcasting Service (PBS), 109

Q

quasars, 13, 58–59, 87, 176, 188, 294
 Queloz, Didier, 201

R

Ramon, Ilan, **215**
 Raytheon, 170n13
 Reagan, Ronald, 21, 39, 41, 282n47
 Rector, Travis A., 133
 Reid, Neill, 116n72, 303
 Resnik, Judith A., **42**
 Richstone, Douglas O., 240n1
 Riess, Adam G., 183–186, **183**, 192
 Ritchey-Chrétien Cassegrain reflecting
 telescope, 54, 71n3
 Robinson, Stephen K., **154**, 170n24
 rockets, 11–15, 41, 46n11
 Rodney, George A., 111n5
 Roe, Robert A., 70
 Roman, Nancy Grace, 15–16, **16**, 309, 315
 Roman Space Telescope. 20, 187, 313,
 315, 326n80
 Rothenberg, Joseph H., 81, **82**, 86, 95–96,
 266, 268
 Rubin, Vera, 187
 Rumsfeld, Donald, 226
 Russia, 11, 102, 334
 Russia (Soviet Union, the)
 Cold War, the, 13, 16, 20–21, 44
 space travel, 11
 Sputnik, 14

S

Sagan, Carl, 135, 298
 Samuel Oschin Schmidt Telescope, 195, 259
 Sandage, Allan, 179
 satellites, 16
 artificial, 12–14
 Cold War, the, 20–21
 communications, 89, 97
 development, 12–14
 electronic images, 121–122
 Explorer, 14
 Explorer 6, 94
 film-based, 121
 first, 14
 Globalstar telephone system, 273
 Hexagon KH-9, 20, 121
 Intelsat VI, 97
 International Geophysical Year (IGY), 14

International Space Station, 46n18, 59
 military, 20, 59
 NASA, 15
 photoreconnaissance, 20
 problems, 102
 reconnaissance, 20, 26–27, 70
 remote sensing, 102
 replacement modules, 91
 servicing missions, 89, 91, 113n30
 Skylab, 16, 46n18, 88
 Solar Maximum, 81, 89, 95, 97, 101
 Space Shuttle, 89
 spectroscope, 12
 Sputnik, 14
 Strategic Defense Initiative (SDI), 21,
 230
 Tracking and Data Relay Satellites
 (TDRS), 58–61, **60**, 249
 Uhuru, 179
 Vanguard, 14
 weather, 59, 98, 102, 121, 255
 Saturn, 11, 35, **78**, 87, 126, 130, 195–200
 rings, 69
 Space Telescope Imaging Spectrograph
 (STIS), 151
 Saturn (rocket), 14
 Savage, Don, 117–118
 Schaefer, William Donald, 38
 Schenk, Harald, **301**
 Scheve, Dave, 270
 Schmidt, Brian P., 181, **181**, 184
 Schmidt, Maarten, 69
 Schmidt telescope, 195, 259
 Schneider, Glenn H., 242n24
 Schreier, Ethan, 307
 Schroeder, Dan, 49n44
 Schulte, Daniel, 80
Science, 102, 189
 Science and Engineering Research
 Council, 291
 Scobee, Francis R., **42**
 Scolese, Chris, 246n72
 Scowen, Paul, 118–119
 Secosky, James, **301**
 Sembach, Kenneth R., 168–169, 239–240,
 276, 297, **297**, 305, 309
 Shannon, Robert R., 111n5
 Shea, Joseph, 98–99
 Sheffield, Ronald L., 89–90
 Shoemaker, Carolyn S., 117, 195

- Shoemaker, Eugene M., 117, 195
- Shriver, Loren J., **4**, 5, 43
- Shull, J. Michael, 242n24
- Sichitiu, Rukmini, **301**
- Silicon Graphics Inc., 269
- Simmons, Larry, 93
- Sky & Telescope*, 130, 302
- Sky at Night*, 316
- Skylab, 16, 46n28, 88, 96
- Slipher, Vesto M., 178
- Sloan Digital Sky Survey, 71, 260, 315
- Smith, Bradford A., 125
- Smith, Michael J., **42**
- Smith, Robert W., 3, 13, 18, 20–21, 39, 123, 158–159
- Big Science, 287
 - Hubble Space Telescope (HST), 18, 202, 335
 - Hubble Space Telescope (HST) costs, 251, 278n1
 - Lockheed Missiles and Space Company, 20
 - Space Shuttle program, 332
 - Space Telescope Science Institute (STScI), 39
- Smith, Steven L., **148**, 149, 151–152, 155, **157**, 158
- Smithsonian American Art Museum, 133–134
- Smithsonian Astrophysical Observatory (SAO), 258–259
- Smithsonian National Air and Space Museum, 35, 57, 93, 97, 101, 331–332, 341n5
- Structural Dynamic Test Vehicle, 100–101
- solar system, the, 13, 35, 117, 126, 195–200, 294. *See also* planets; individual planet names; individual moon names
- Galileo (Galileo Galilei), 45n2
- Space Exploration Initiative, 70, 98–99
- Space Infrared Telescope Facility (SIRTF), 40–41
- Space News*, 70, 278n4
- Space Place, 332
- Space Race, the, 13–14, 332
- Space Shuttle, 21, 44, 51n57
- astronauts, 32, 35, 43
 - Atlantis, 41–42, 217, 231, 234–239 crew, **237**
 - flight deck, **330**, 338
 - payload bay, 42, 114n50, 235, 238
- budgets, 101
- Challenger, 32, 88–89
- crew, **42**, 44
 - loss of, 6n1, 43–44, 44, 51n67, 67, 70, 89, 219, 242n20, 260, 295
 - loss of (costs), 278n1
- Columbia, 32, 41, 44, 155, 156, 163, 214
- crew, **215**
 - loss of, 214–216, 225, 231, 243n30, 245n60, 334
 - SM3B, 164
 - SM4, 214
- Columbia Accident Investigation Board (CAIB), 216, 218–222
- COSTAR (Corrective Optics Space Telescope Axial Replacement), 101
- costs, 32, 34, 92, 101, 251, 278n4, 332
- damage, 44
- delays, 23, 43, 156–158, 214–215, 234
- described, 32
- Discovery, 1–3, 5–6, 6n1, 9, 32, 43, 44, 53, 150–159, 217, 231
- crew, **4**
 - HST launch, 55
 - HST service, 156–159, **157**
 - payload bay, **3**, 262
- Endeavour, 92, 97, 99, 101, 103–107, 217
- payload bay, 235
 - standby, 234–235
- ending of, 278n4, 334
- Flight Support System (FSS), 91, 101, 103, 114n50, 150
- history of service, 239
- Hubble Space Telescope (HST), 1–6, **3**, **4**, 9, 54, 143
- aperture door, 61
 - deployment, 60–61
 - Fine Guidance Sensors, 83
 - launch, 42
 - relationship, 332–335
 - servicing missions, 35, 54, 61, 69, 78, 81–83, 88–110
 - servicing missions, end of, 239
- hydrogen leaks, 69
- improvements, 44
- infrared observing capabilities, 40–41

- ISS servicing missions, end of, 239
 launch, 1–3
 launch delays, 6n1
 Launch on Need missions, 231
 manifests, 169n7
 milestones, 154, 159, 215
 military programs, 21
 mission numbers, 7n11
 Musgrave, Story, 96–97
 Nixon, Richard M., 17
 Optical Telescope Assembly (OTA), 17, 19
 Orbital Replacement Units, 35, 101
 payload bay, 1, **3**, 21, 40, 54, 89, 91, 101, 151–152
 payloads, 32, 44, **162**
 problems, 31, 43, 98, 156–158, 212–218
 proposed, 16–17
 Remote Manipulator System (RMS), **3**, 91, 99, 103–106, **148**, 149–150, 155–159, 165, 235
 retirement, 221
 robotic systems, 227
 Servicing Mission 1 (SM1), 143
 Servicing Mission 2 (SM2), 302
 servicing missions, 89
 Solar Array Carrier, 101
 Solar Maximum, 89
 Space Infrared Telescope Facility (SIRTF), 40–41
 Space Telescope main mirror, 22
 space telescopes, 17
 spacewalkers, 88
 STS-6, 88, 96
 STS-21, 115n59
 STS-31 (Hubble deployment mission), **3**, **4**, 5–6, 6n1, 43, 45n1, 51n67, 90, 97, 113n32, 114n50, 164, 256
 STS-41C, 89, 101
 STS-41D, 44
 STS-49, 97–99
 STS-51, 102
 STS-51A, 113n30
 STS-51I, 113n30
 STS-51L, 42
 STS-54, 102
 STS-57, 102
 STS-61 (SM1), 99–110, **104**, 115n59, 152
 STS-61J, 51n67
 STS-82 (SM2), **148**, 149–153, 162
 STS-95 crew, **154**, 170n24
 STS-103 (SM3A), 156–159, **157**, 171n33
 STS-104, 155
 STS-107 (Spacehab/Columbia), 214–216, 245n60
 STS-109 (SM3B), 159–167
 STS-114, 231
 STS-115, 231
 STS-121, 231
 STS-125 (SM4), 234–239, **272**, 338
 STS-126, 235
 STS-400 (standby rescue mission), 234–235
 Support Systems Module, 17, 19, 22
 Tracking and Data Relay Satellites (TDRS), 59
 Wide Field/Planetary Camera 2 (WFPC2), 82, 101–103
 Y2K concerns, 156–159
 Young, John W., 51n67
 Space Telescope, 18–44, 36, 78, 251–252.
 See also Large Space Telescope (LST)
 astronomers, 292
 astronomers' lobby, 22, 37–38, 120–123
 Charge-Coupled Devices (CCD) detectors, 123
 Congress, U.S., 25
 costs, 18, 23–24, 26–27
 criticism of, 25
 delays, 23
 design, 22
 electronic images, 121–122
 European Space Agency (ESA), 22–23
 Fine Guidance System, 19, 23
 funding, 23–24
 history of, 260–262
 launch schedule, 23
 Lockheed Missiles and Space Company, 23
 mirror (main), 26–30
 observing time, 292
 Perkin-Elmer Corporation, 23
 problems, 25
 reductions, 23, 26
 Request for Proposals (RFPs), 22, 32
 roles and responsibilities, 37
 Science Working Group, 122–126
 security, 23

- Space Telescope Development Division, 39
- Space Telescope Science Institute (STScI), 37–38
 - support for, 23–24
 - ultraviolet spectrographs, 22
 - ultraviolet wavelengths, 123
 - Wide Field/Planetary Camera (WF/PC), 123
- Space Telescope: A Study of NASA, Science, Technology and Politics*, 13
- Space Telescope Advisory Council, 176,
- Space Telescope Advisory Committee (STAC), 266, 294
- Space Telescope European Coordinating Facility (ST-ECF), 83–84, 252–253, **253**, 279n10, 311
- Space Telescope Institute Council, 266
- Space Telescope Operations Control Center (STOCC), 5, 59, 256–257, **257**, 260–266, **265**, 270–273, **271**
- Space Telescope Science Institute (STScI)
 - Association of Universities for Research in Astronomy (AURA), 38–39, 252, 266–267, 274, 276, 306–309
 - astronomers, 65, 249, 292–300
 - astronomers, amateur, 300–303
 - Astronomy Visualization Laboratory, 129
 - Barbara A. Mikulski Archive for Space Telescopes, 313
 - bias at, 305
 - budget cuts, 267–268
 - Burrows, Christopher, 64, 80
 - Chaisson, Eric J., 62
 - COSTAR (Corrective Optics Space Telescope Axial Replacement), 88, 94–95
 - costs, 274
 - created, 37–39, 260–261, 277
 - criticism of, 39
 - Crocker, James, 94
 - data archive, 287–288, 292–293
 - Early Release Observation, 127
 - Education and Public Affairs Office, 126–127
 - European Space Agency (ESA), 252–254
 - European Space Agency (ESA) collaboration, 252
 - General Observer Support Branch, 293
 - Giacconi, Riccardo, 38, 74n29, 83
 - Guaranteed Time Observers (GTOs), 292, 295–296
 - Guide Star Catalog, 260, 273
 - headquarters, **255**
 - Hornig committee, 37, 39
 - Hornig report, 261, 292
 - HST and Beyond committee, 209–210
 - Hubble Archive Re-Engineering Project (HARP), 312
 - Hubble Deep Field (HDF), 304
 - Hubble Space Telescope (HST)
 - data, 319
 - data archive, 311–316
 - data path, 59–60, **60**, 300
 - efficiencies, 269–270
 - “First Light,” 62–65
 - fixes, 110
 - images, 125–126, 131
 - observing cycles, 176, 258, 287, 292, 322n34
 - observing time allocation, 294–304
 - power down, 165
 - Second Decade Committee, 303
 - Servicing Mission 4 (SM4), 275
 - spherical aberration, 65–66, 126–127
 - star catalog, 44
 - Strategy Panel, 83–88
 - verification, 54
 - HubbleSite, 128–129, 316
 - imaging (digital), 129, 139n34
 - internet, the, 128, 139n31
 - James Webb Space Telescope (JWST), 210–211, 274
 - Macchetto, Duccio, 24
 - management, 39
 - minorities, 305–310
 - Multi-mission Archive (MAST), 313
 - Next Generation Space Telescope (NGST), 274
 - Office of Public Outreach, **129**, 140n39
 - Panoramic Survey Telescope and Rapid Response System (Pan-STARRS), 313
 - Partnerships, 266, 274
 - Project to Re-Engineer Space Telescope Observing (PRESTO), 312
 - rivalries, 274–275
 - roles and responsibilities, 254–260, 262, 275
 - Servicing Mission 1 (SM1), 101

- Servicing Mission 4 (SM4) cancellation, 308
 Sloan Digital Sky Survey, 71, 260, 315
 staff, 267, 279n7
 staff cuts, 302
 successes, 274
 Supernova 1997ff, 183
 Time Allocation Committee (TAC), 294–296, 303–305, 317–318
 Wide Field Camera 3 (WFC3), 213, **228**
 women, 305–310
 Women at Work: a Meeting on the Status of Women in Astronomy, **307**
- Space.com, 278n4
 spacecraft, 15, 44, 57
 Advanced X-ray Astrophysics Observatory (AXAF), 40–41
 Apollo, 14, 130, 270
 Apollo program, 334
 Cassini, 196–198
 classified, 20
 commissioning, 53
 Cosmic Background Explorer (COBE), 188
 data, 125–126
 Department of Defense, 20, 36
 future of, 334
 Galileo, 98, 196–197
 Gemini program, 51n67, 88, 99
 Giotto, 252
 Great Observatories program, 41
 Huygens probe, 198
 Juno, 196
 Kepler, 201
 Mars Pathfinder, 128
 Mercury program, 154
 New Horizons, 196, 199
 Pioneer spacecraft, 196–198
 Planck, 186, 188
 robotic, 14, 32, 53, 90–91, 121, 143, 227, 341n7
 servicing missions, 32, 78, 89
 simulated, 88, 95
 Solar Maximum, 81, 89, 95, 97, 101
 Titan, 198
 Tracking and Data Relay Satellites (TDRS), 59
 Transiting Exoplanet Survey Satellite (TESS), 201
 Ulysses, 196
 untethered EVAs, 7n11
 Voyager I spacecraft, 125
 Voyager spacecraft, 63, 118, 125, 130, 137n9, 137n18, 196–198
 Wilkinson Microwave Anisotropy Probe (WMAP), 185–186, 188
Spaceman: An Astronaut's Unlikely Journey to Unlock the Secrets of the Universe, 172n43, 341n8
 spacewalking, 5, 42, 54
 astronauts, **148**
 difficulties of, 88–89, 99–100
 equipment, 96, 100
 Gemini program, 88
 history of, 112n28
 International Space Station, 152
 Lockheed Missiles and Space Company, 89–90
 NASA confidence in, 152–153
 problems, 97–98
 simulated, 99–100
 STS-82 (SM2) crew, **148**
 three-person, 97
 untethered, 7n11, 88
 women, 4–5, 7n11, 42–44, 88–90, 112n28, 164. *See also* individual astronaut names
- Spain, 59–60, 254
 Spitzer, Jr., Lyman S., 9, 12–13, **13**, 41
 Copernicus satellite, 15
 Hubble Space Telescope (HST) long exposures, 189
 Hubble Space Telescope (HST) Strategy Panel, 83–84
 Large Space Telescope (LST), 15, 17–18
 Space Telescope Science Institute (STScI), 37
 Spitzer Space Telescope, 9, **40**, 41, 134, 193, 195, 297, 304
 exoplanets, 201–202
 “faster, better, cheaper” policy, 167
 galaxies, redshifted, 210
 Small Magellanic Cloud, **9**
 Spitzer Science Center, 318
 “Spitzer Warm Mission,” 41
 Spoelhof, Charles P., 111n5
 Stafford, Thomas, 99, 102
Starry Messenger, 45n2
 stars, 23, 40, 176

- 30 Doradus, 86–87, **108**, 109, 112n23
 AGK+81°266, 107
 artificial reference stars, 135
 atmosphere, 25
 balloons, 153
 Betelgeuse, 25
 Big Dipper, 190
 black holes, 25, 117, 151, 176, 187–188, 304
 Bubble Nebula, **xi**, **122**, 130
 Bug/Butterfly Nebula, 135, **209**, 238
 Canes constellation, 175
 Carina constellation, 62
 Carina Nebula, 200, 229
 Cassiopeia constellation, 122
 Catalogue of Nebulae and Star Clusters, 119
 Cat’s Eye Nebula, 200
 Cepheid variables, 177–180, 186
 Cephus constellation, 65–66
 Cetus constellation, **194**
 Cone Nebula, **329**
 Crab Nebula, 69, **77**, **122**
 distances between, 176–177
 Eagle Nebula, 116n71, **117**, 118–120, **119**, 120, 127, 135, **337**
 Eta Carinae star system, 109, **389**
 globular clusters, 13, 25
 Great Nebula in Orion, 109
 Guide Star Catalog II, 260
 guide stars, 258–260
 HD209458, 201
 HD96755, 63
 Helix Nebula, 200
 Herbig-Haro Jet, **53**
 Horsehead Nebula, 229, **287**
 Hubble Space Telescope (HST) distance measurements, 56
 Hydra constellation (NGC 3717), **381**
 Infrared Astronomical Satellite, 144
 interstellar medium, 294
 Keyhole Nebula, **343**
 Large Magellanic Cloud, 86, **108**, 186, 200, 315
 M1, 122
 M16, 119
 magnitude, 30, 258
 masses, 30
 Melnick 34, **108**
 Monkey Head Nebula (NGC 2174), **vii**
 motion, 23, 30
 movement, 258–259
 nebulae, 10, **53**, 118–119, 122, 126, 151, 176–177, 315
 neutron stars, 338, 342n17
 NGC 188 star cluster, 65–66
 NGC 2174, **vii**
 NGC 2264, **329**
 NGC 2392 Nebula, 159, 200
 NGC 3532 star cluster, 62–63, **63**
 NGC 7635, **xi**, **122**
 Nova Cygni 1992, 109
 novae, 302, 315
 Orion Nebula, **v**, 87, 109, 200
 Pegasus constellation, 201
 “Pillars of Creation” image, 116n71, **117**, 118–120, **119**, 127, **337**
 planets, 201
 quasars, 294
 Ring Nebula, 130, 200
 Sagittarius Star Field, 130
 Saturn’s rings, 69
 Serpens constellation, 119
 Sirius, 258
 Smithsonian Astrophysical Observatory (SAO), 258
 Sombrero Nebula, 130
 spectra, 10, 12
 star catalog, 44, 252, 258–260
 star clusters, 126, 176
 star field comparison, 273
 stellar astrophysics, 294
 stellar magnetic fields, 302
 stellar populations, 294, 304, 329
 Supernova 1987A, 25, 109, 117, 134, 200–201
 Supernova 1997ff, 183
 supernovae, 87, 117, 151, 181–182, 194–195, 299, 315, 335
 Supernoval Cosmology Project (SCP), 181
 Tarantula Nebula, 86–87, **108**, 109, 112n23
 Taurus constellation, 122
 Trifid Nebula, 130
 Tucana constellation, 192
 ultraviolet, 12
 Ursa Major, 190, 269–270
 variable stars, 23
 Westerlund 2 cluster, **249**

- white dwarves, 25
 - Steward Observatory, 179
 - Stockman, Peter, 86, 240n1, 267
 - Strategic Defense Initiative (SDI), 21, 230
 - Sturch, Conrad R., 260
 - Sullivan, Kathryn D., **4**, 45n1, 113n32
 - EVAs, 5, 7n11, 42, 88–90, 112n28
 - Handprints on Hubble*, 341n8
 - Hubble Space Telescope (HST) deployment, 42–44, 45n1, 164, 341n8
 - Hubble Space Telescope (HST) servicing missions, 115n59
 - Sun (company), 269
 - Sun, the, 10, 23, 190
 - Advanced Camera for Surveys (ACS), 161
 - black holes, 188
 - Galileo (Galileo Galilei), 45n2
 - Hubble Space Telescope (HST), 53
 - movement around, 56
 - orbit, 41
 - spectra, 12, 40
 - Suntzeff, Nicholas, 182
 - Superman* (comic book), 17
- T**
- Tanner, Joseph R., **148**, 149–153
 - Taylor, Joseph, 229, 242n29
 - telescopes, 65, 131, 134. *See also* observatories; individual observatory and telescope names
 - Apollo 16, 16
 - astronauts, 16
 - astronomers, **4**, 5–6, 13, 16, 37, 287–292
 - amateur, 118, 123–124, 135, 137n12
 - professional, **290**
 - astronomers' lobby, 41
 - astronomical, 20
 - Chandra X-Ray Observatory, **40**
 - Charge-Coupled Devices (CCD) detectors, 290
 - Compton Gamma Ray Observatory, **40**
 - computers, 135
 - data, 41, 134, 318–319
 - development, 9–11, 11–12, 37
 - differences between, 135
 - film-based, 289–290
 - fixes, 11
 - Gamma Ray Observatory (GRO), 40–41
 - Gemini telescopes, 280n15
 - Great Observatories program, 40–42, **40**
 - ground-based, 135, 210, 290, 293, 336
 - Hawaii, 131, 134–135, 318
 - Hubble Space Telescope (HST) relationship, 335
 - image quality, 135
 - infrared observing capabilities, 210
 - invented, 9
 - Lockheed Missiles and Space Company, 20
 - mirrors, 9, 26, 71n3
 - Moon-based, 210
 - National Reconnaissance Office, 20
 - optical, 71n3, 135, 175
 - Perkin-Elmer Corporation, 20
 - radio, 288
 - reflecting, 9, 11, 12
 - refracting, 9
 - remote observation, 289
 - space, 9, 11–15, 46n11, 144, 291, 336
 - Space Shuttle, 16–17
 - space telescopes, 42, 175, 210
 - space travel, 124
 - spacecraft, 218
 - spectrograms, 124
 - temperature, 11, 29, 61, 64, 135, 144
 - ultraviolet, 291
 - ultraviolet observing capabilities, 335–336
 - ultraviolet spectrometer, 15
 - visible light, 335–336
 - Texas Instruments, 35
 - Thomas, Lewis, **301**
 - Thompson, Rodger I., 145, 184
 - Thornton, Kathryn C., 98–99, 103–105, **104, 106**
 - Thronson, Harley A., 240n1, 317, 327n91
 - Thuot, Peter, 97
 - Time*, 120
 - Tinsley Laboratories, 94–95
 - Tobias, Sheila, 307
 - Tombaugh, Clyde, 199
 - Tonry, John L., 240n1
 - Transiting Exoplanet Survey Satellite (TESS), 201, 313, 315
 - Trauger, John, 78–79, 92–93, 109–110
 - Truly, Richard H., 98–99
 - Truran, James, 240n1
 - TRW, Inc., 98, 210–211, 260

U

Udall, Mark, 225
 Uhuru satellite, 179
 UK Schmidt Telescope, 259
 UK Science and Engineering Research Council, 291
 United Kingdom, 259, 291
 United Technologies Corporation, 170n13
 universe, the, 2–3, 9–10, 13, 40, 78, 147, 175–202, 233, 294, 304, 332
 age of, 87, 177–181, 185–187, 335
 Big Bang, the, 180, 186, 188, 193
 dark energy, 329, 339
 dark matter, 187, 329, 339
 early formation, **180**
 expanding, 10, 177–179, 182–192, 203n7, 288, 315, 335
 Milky Way galaxy, the, 10, 177–178, 195
 size of, 23, 30, 56–57, 87, 181, 294, 335
 University of Wisconsin Space Place, 69
 Uranus, 122, 151, 198–199
 Urry, Meg, 307
USA Today, 2, 103, 278n1

V

Van Allen, James, 15
 Van Allen radiation belt, 155, 264, 332–333
 South Atlantic Anomaly, 115, 264, 270, 332
 van Hoften, James, 89
 Venus, 9, 199
 Very Large Array, 289, 312–313
 Villard, Ray, 72n14, 73n21, 86, 117–118, 126–127, 131, 133, **133**, 235
 von Braun, Wernher, 14, 134, 333
 Voyager spacecraft, 63, 118, 125, 130, 137n9, 137n18, 196–198

W

Wall Street Journal, the, 3, 278n1
 Walters Art Museum, 135
Washington Post, the, 2–3, 70, 107, 126, 221
 Block, Herbert L. (Herbblock), 77
 Hubble Space Telescope (HST) costs, 6n4, 278n1
 Hubble Space Telescope (HST) mirror defects (cartoon), **77**
Washington Times, the, 2
 Watzke, Megan, 133

Weiler, Edward J., 35, 68–69, 71, 75n37, 77–79, 107, 119, **217**, 246n72, 309
 Advanced Camera for Surveys (ACS), 159
 astronomers, 293
 Columbia, loss of, 216, 219
 Dressler report, the, 240n1
 Hubble Space Telescope (HST)
 fixes, 109, 216, 218, 238
 General Observers (GOs), 293
 robotic mission, 225
 Servicing Mission 4 (SM4), 219–222, 230, 238, 243n30, 243n43, 246n70, 278n4
 minorities, 309
 NASA budgets, 283n50, 293
 O’Keefe, Sean, 243n43
 rivalries, 110
 Space Shuttle manifests, 169n7
 Wide Field/Planetary Camera 2 (WFPC2), 82, 93, 119, 144–145
 replacement, 212–213
 women, 309
 Weiss, Benjamin, **301**
 Welch, James C., 39
 Wenz, Michael, 165
 Westfall, John E., 323n40
 Westphal, James A., 125–126
 Charge-Couple Device (CCD), 123
 Hubble Space Telescope (HST) images, 63, 65, 125–126
 Space Telescope, 22, 123
 Wide Field/Planetary Camera (WF/PC), 34, 63, 74n36
 White, Nicholas, 310
 Wide Field Infrared Survey Telescope (WFIRST), 20, 187, 313, 315, 326n80. *See also* Nancy Roman Space Telescope
 Williams, Robert E., 130, 182, 189–193, **189**, 267, 274, 302, 312
 Wilson, Raymond, 83
 Wiseman, Jennifer, 225, **236**, 319, 337
 Wolff, Sidney C., 69
 women, 7n11, 88, 275, 287, 305, 325n58, 351–355
 Women at Work: A Meeting on the Status of Women in Astronomy, **307**
 Wood, H. John, 80, 87–88, 108
 Woodgate, Bruce, 145, 150

X

XMM-Newton Observatory/X-Ray
Telescope, 195, 304

Y

Yerkes Observatory, 10, 327n91
Young, A. Thomas, 38
Young, John W., 42–43, 51n67, 99

Z

Zooniverse, 316
Zwicky, Fritz, 46n11, 181, 187

NOT YET IMAGINED

A STUDY OF HUBBLE SPACE TELESCOPE OPERATIONS

The Hubble Space Telescope (HST) is the most famous astronomical instrument of its time and one of the best-known robotic vehicles ever put into space. Its launch and deployment into low-Earth orbit from the Space Shuttle Discovery in April 1990 appeared to fulfill the plans and dreams of astronomers since the beginnings of space exploration to place a telescope beyond the distorting effects of Earth's atmosphere.

The first images from Hubble contained a stunning surprise—the space telescope's main mirror had been precisely ground to the wrong shape. Although HST's images were still superior to anything available from ground-based telescopes, the Hubble Telescope instantly became a byword for incompetence.

With the future of NASA on the line, scientists and engineers devised fixes for the spherical aberration afflicting Hubble, and astronauts flying on the first of five servicing missions to HST installed new instruments that restored the Space Telescope's capabilities to those promised when it was launched. Within weeks, HST produced the breathtaking images and other data that astronomers and the public had long anticipated, and soon Hubble shed its former image as it became a symbol of American technological and scientific prowess.

Not Yet Imagined documents the history of HST from its launch through its first 30 years of operation in space. It focuses on the interactions among the general public, astronomers, engineers, government officials, and members of Congress during that time. The decision-making behind the changes in Hubble's instrument packages on servicing missions that made HST a model of supranational cooperation amongst scientists is chronicled, along with HST's contributions to our knowledge about our solar system, our galaxy, and our universe. This book also covers the impact of HST and the images it produces on the public's appreciation for the universe, and how HST has changed the ways astronomy is done.

ABOUT THE AUTHOR

Christopher J. Gainor is the editor of *Quest: The History of Spaceflight Quarterly*. His books include *The Bomb and America's Missile Age* (2018), *To a Distant Day: The Rocket Pioneers* (2008), and *Arrows to the Moon: Avro's Engineers and the Space Race* (2001). His research interests include aircraft, missile, and space programs in the years following World War II. He has served as President of the Royal Astronomical Society of Canada, and he has a doctoral degree in the history of technology from the University of Alberta, a master of science degree in space studies from the University of North Dakota, and a bachelor of arts degree in history from the University of British Columbia.

FRONT COVER: Hubble image of the Lagoon Nebula
(Credit: NASA, ESA, and STScI); The Hubble Space Telescope in May 2009 (Credit: NASA)

BACK COVER: Hubble image of the Bubble Nebula
(Credit: NASA, ESA, and the Hubble Heritage Team [STScI/AURA])

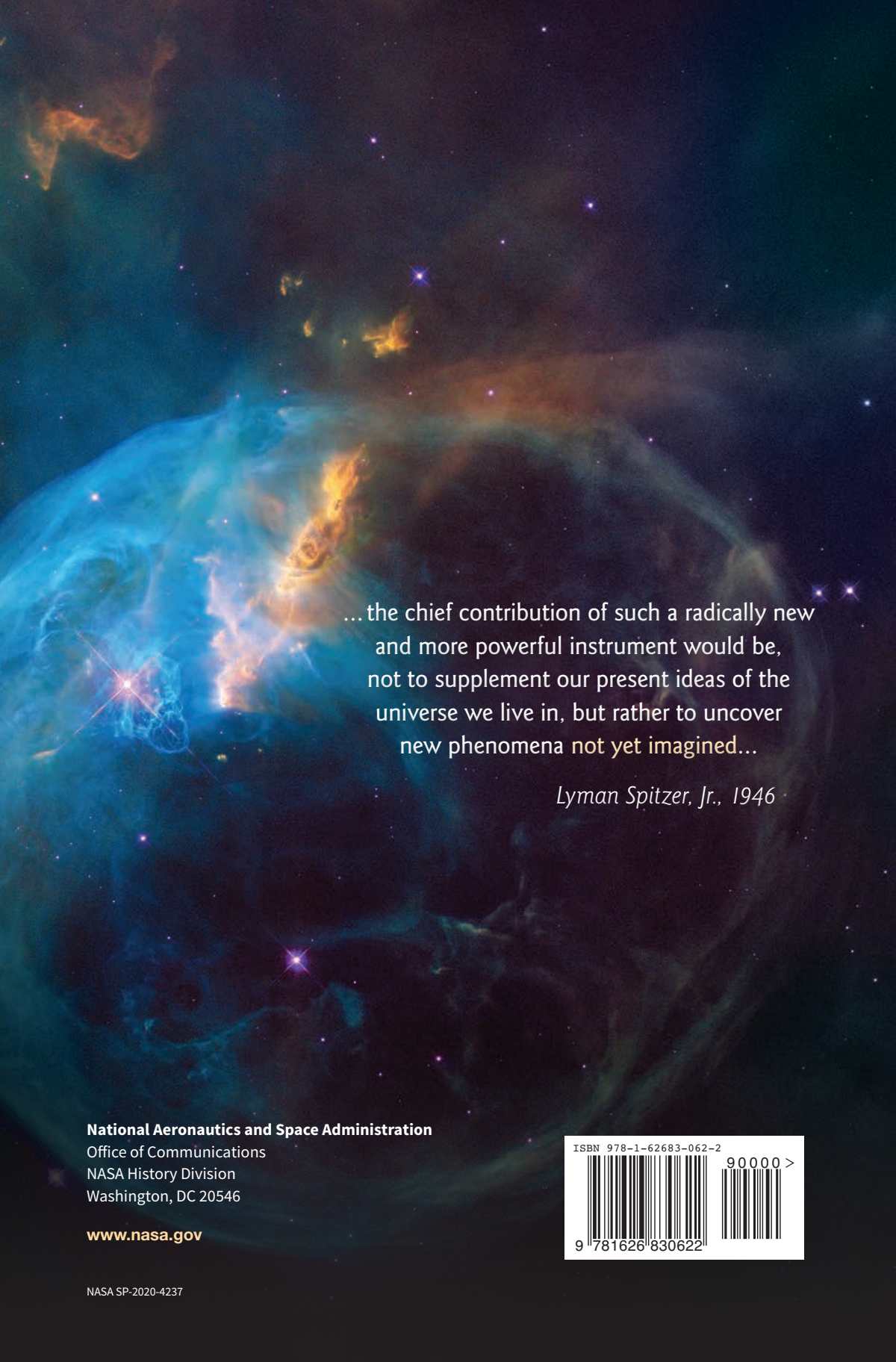

... the chief contribution of such a radically new
and more powerful instrument would be,
not to supplement our present ideas of the
universe we live in, but rather to uncover
new phenomena *not yet imagined...*

Lyman Spitzer, Jr., 1946

National Aeronautics and Space Administration
Office of Communications
NASA History Division
Washington, DC 20546

www.nasa.gov

