

National Aeronautics and Space Administration



NASA Planetary Mission Concept Study for the Astrobiology and Planetary Decadal Survey

# NEPTUNE ODYSSEY:

## MISSION TO THE NEPTUNE-TRITON SYSTEM

August 2020

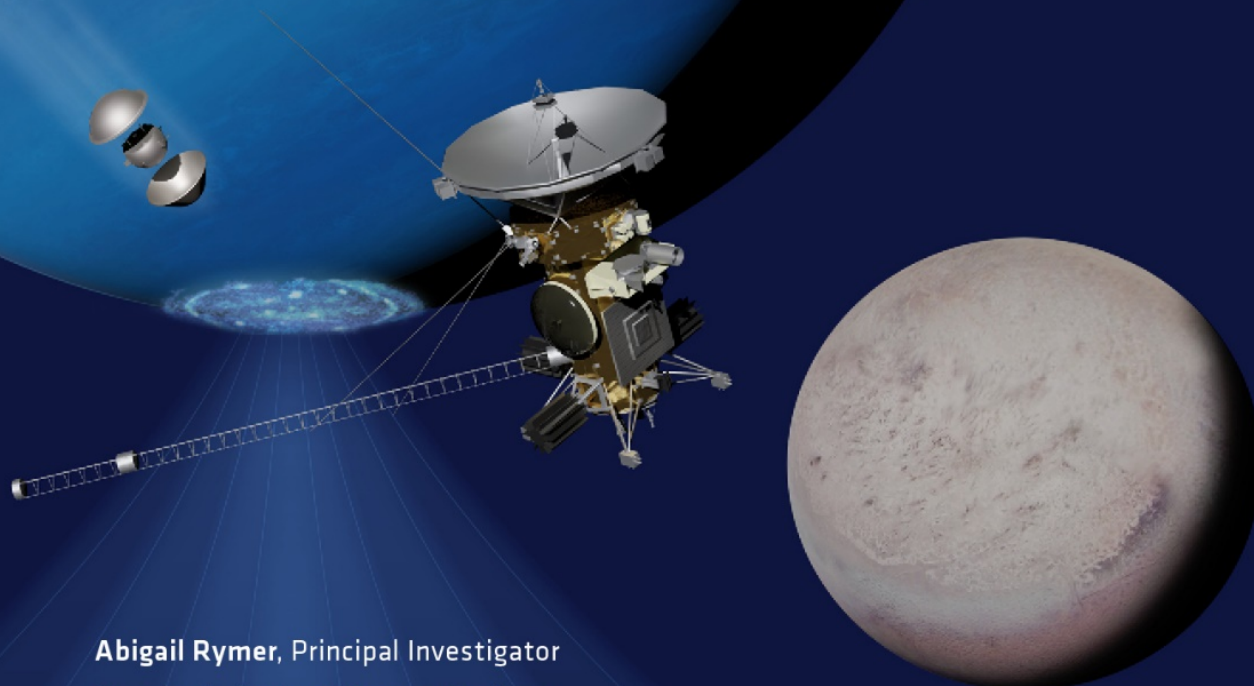

**Abigail Rymer**, Principal Investigator

**Brenda Clyde**, Lead System Engineer

**Kirby Runyon**, Project Scientist

Along with a large national and international team of scientists and engineers

Point of contact: [Abigail.Rymer@jhuapl.edu](mailto:Abigail.Rymer@jhuapl.edu)



# Concept Study Team

We are enormously proud to be part of a large national and international team many of whom have contributed their time in order to make this study a very enjoyable and productive experience. Advancing science despite the lockdown.

Team Member	Role	Home Institution	Team Member	Role	Home Institution
<b>Abigail Rymer</b>	Principal Investigator	APL	<b>George Hospodarsky</b>	Plasma Wave Expert	U. of Iowa
<b>Kirby Runyon</b>	Project Scientist	APL	<b>H. Todd Smith</b>	Magnetospheric Science	APL
<b>Brenda Clyde</b>	Lead Engineer	APL	<b>Hannah Wakeford</b>	Exoplanets	U. of Bristol, UK
<b>Susan Ensor</b>	Project Manager	APL	<b>Imke de Pater</b>	Neptune expert	Berkeley
<b>Clint Apland</b>	Spacecraft Engineer	APL	<b>Jack Hunt</b>	GNC Engineer	APL
<b>Jonathan Bruzzi</b>	Probe Engineer	APL	<b>Jacob Wilkes</b>	RF Engineer	APL
<b>Janet Vertisi</b>	Sociologist, teaming expert	Princeton	<b>James Roberts</b>	Geophysicist	APL
<b>Kenneth Hansen</b>	NASA HQ Representative	NASA HQ	<b>Jay Feldman</b>	Probe Engineer	NASA Ames
<b>Krista Soderlund</b>	Neptune WG Co-lead	U. of Texas	<b>Jeremy Rehm</b>	Outreach	APL
<b>Kunio Sayanagi</b>	Neptune WG Co-lead	Hampton U.	<b>Jorge Nunez</b>	Payload Manager	APL
<b>Alan Stern</b>	Triton WG Co-lead	SwRI	<b>Joseph Williams</b>	Probe Engineer	NASA Ames
<b>Lynne Quick</b>	Triton WG Co-lead	GSFC	<b>Juan Arrieta</b>	Tour Design	NablaZero lab
<b>Tracy Becker</b>	Icies and Rings WG Co-lead	SwRI	<b>Kathleen Mandt</b>	Triton Science	APL
<b>Matthew Hedman</b>	Icies and Rings WG Co-lead	U. of Idaho	<b>Kelvin Murray</b>	Schedule	APL
<b>Ian Cohen</b>	Aurora/Mag WG Co-lead	APL	<b>Kevin Stevenson</b>	Exoplanets	APL
<b>Frank Crary</b>	Aurora/Mag WG Co-lead	U. of Colorado	<b>Kurt Gantz</b>	Mechanical Design Engineer	APL
<b>Jonathan Fortney</b>	Exoplanets WG Lead	UCSC	<b>Larry Wolfarth</b>	Cost Analysis	APL
<b>Adam Masters</b>	Magnetospheric Science	Imperial College	<b>Leigh Fletcher</b>	Physicist	U. of Leicester
<b>Alex Patthoff</b>	Triton Science	PSI	<b>Linda Spilker</b>	Advisor and Physicist	JPL
<b>Amy Simon</b>	Neptune Science	NASA-GSFC	<b>Mark Hofstadter</b>	Neptune Science	JPL
<b>Andrew Annex</b>	Graduate Student	JHU	<b>Martin Ozimek</b>	Trajectory Design and Launch Vehicle Trades	APL
<b>Candy Hansen</b>	Advisor and Triton Science	PSI	<b>Mike Norkus</b>	Mission Operations	APL
<b>Carol Paty</b>	Magnetospheric Science	U. of Oregon	<b>Noam Izenberg</b>	Triton Hopper	APL
<b>Chris Krupiarz</b>	Flight Software	APL	<b>Parisi Marzia</b>	Neptune Science	JPL
<b>Christian Campo</b>	Avionics	APL	<b>Paul Schenk</b>	Triton Science	LPI
<b>Christopher Scott</b>	Mission Design	APL	<b>Ralph McNutt</b>	Advisor and Physicist	APL
<b>Corey Cochran</b>	Triton Induction Analysis	JPL	<b>Robert Stough</b>	SLS Representative	NASA
<b>Dan Gallagher</b>	Power Engineer	APL	<b>Robin Vaughan</b>	APL Lead Engineer (Alumnus)	APL
<b>Dan Rodriguez</b>	Avionics	APL	<b>Romina Nikoukar</b>	Probe Instrument Manager	APL
<b>Dana Hurley</b>	Physicist	APL	<b>Ron Vervack</b>	UV Expert	APL
<b>Dinesh Prabhu</b>	Probe Engineer	ARC	<b>Sarah Moran</b>	Graduate Student	JHU
<b>Doug Crowley</b>	Power Engineer	APL	<b>Seth Kijewski</b>	Propulsion Engineer	APL
<b>Elena Provornikova</b>	Heliophysicist	APL	<b>Soumyo Dutta</b>	Probe Engineer	NASA Langley
<b>Elizabeth Abel</b>	Thermal Engineer	APL	<b>Tom Spilker</b>	Advisor and Physicist	n/a
<b>Elizabeth (Zibi) Turtle</b>	Triton and Satellite Science	APL	<b>Tom Stallard</b>	Neptune Science	U. of Leicester
<b>Emily Martin</b>	Seismologist (Triton)	Smithsonian	<b>Weilun Cheng</b>	Spacecraft Mechanical Engineer	APL
<b>Gary Allen</b>	Probe Engineer	NASA Ames			

# Data Release, Distribution, and Cost Interpretation Statements

This document is intended to support the 2023–2032 Planetary Science and Astrobiology Decadal Survey.

The data contained in this document may not be modified in any way.

Cost estimates described or summarized in this document were generated as part of a preliminary concept study, are model-based, assume an APL in-house build, and do not constitute a commitment on the part of APL.

Cost reserves for development and operations were included as prescribed by the NASA ground rules for the Planetary Mission Concept Studies program. Unadjusted estimate totals and cost reserve allocations would be revised as needed in future more-detailed studies as appropriate for the specific cost-risks for a given mission concept.

# Planetary Mission Concept Study

## Final Report

<b>CONCEPT STUDY TEAM</b> .....	<b>I</b>
<b>DATA RELEASE, DISTRIBUTION, AND COST INTERPRETATION STATEMENTS</b> .....	<b>II</b>
<b>LIST OF FIGURES</b> .....	<b>VI</b>
<b>LIST OF TABLES</b> .....	<b>VI</b>
<b>EXECUTIVE SUMMARY</b> .....	<b>IX</b>
<b>1. SCIENTIFIC OBJECTIVES</b> .....	<b>1</b>
Science Traceability Matrix .....	1
Science Closure .....	5
1. Neptune (Ice Giant and Exoplanet) Origins .....	5
2. Neptune’s Strange Magnetic Field and Magnetospheric Processes .....	6
3. Triton as an Ocean World .....	8
4. Triton as a Kuiper Belt Dwarf Planet: Comparative Planetology (STM-T4) .....	9
5. Small Satellites and Rings .....	9
Cross-Disciplinary Science Opportunities: Exoplanets and Cruise Phase Science .....	10
<b>2. HIGH-LEVEL MISSION CONCEPT</b> .....	<b>11</b>
Overview .....	11
Concept Maturity Level and Technology Maturity .....	12
Power/Radioisotope Thermoelectric Generator (RTG) Trades .....	12
Launch Vehicle Trades .....	13
Opportunities for Future Improvements .....	15
Preserving Knowledge and Cultural Continuity .....	16
<b>3. TECHNICAL OVERVIEW</b> .....	<b>17</b>
Orbiter Instrument Payload Description .....	17
Probe Instrument Payload Description .....	18
Science Data Rates and Volume .....	19
Orbiter Flight System .....	19
Guidance, Navigation, and Control (GNC) .....	21
Spacecraft RF Communications Subsystem (Orbiter) .....	22
Propulsion .....	22
Orbiter and Probe Avionics .....	22
Power .....	23
Mechanical .....	24
Thermal .....	25
Probe Flight System .....	25
Thermal Protection System .....	26
Concept of Operations and Mission Design .....	27
Interplanetary Trajectory .....	27
Launch Vehicle Options .....	28
Approach to Neptune .....	28



Neptune Orbit Insertion .....	29
Triton Tour.....	29
Probe Deployment .....	31
Risk Analysis .....	32
<b>4. DEVELOPMENT SCHEDULE AND SCHEDULE CONSTRAINTS .....</b>	<b>33</b>
High-Level Mission Schedule .....	33
Development Schedule and Constraints .....	34
<b>5. MISSION LIFE-CYCLE COST .....</b>	<b>34</b>
Introduction .....	34
Mission Ground Rules and Assumptions .....	34
Cost Benchmarking .....	35
Cost Estimate .....	35
Confidence and Cost Reserves.....	37
<b>APPENDIX A. ACRONYMS AND GLOSSARY OF TERMS .....</b>	<b>A-1</b>
<b>APPENDIX B. DESIGN TEAM STUDY REPORT .....</b>	<b>B-1</b>
High-Level Mission Concept.....	B-1
Trade Study Summary Data .....	B-1
Triton Lander Study .....	B-1
Launch Vehicle Trades.....	B-2
Technical Overview .....	B-2
Orbiter Payload Images.....	B-4
Details for Each Orbiter Instrument .....	B-5
Probe Instrument Payload Description .....	B-12
Probe Payload Images .....	B-13
Details for Each Probe Instrument.....	B-14
Science Data Rates and Volume.....	B-17
Orbiter Flight System .....	B-19
Guidance, Navigation, and Control (GNC) .....	B-22
Propulsion.....	B-22
Orbiter Avionics .....	B-23
Probe Avionics.....	B-24
Probe Electrical Power System .....	B-24
Power Modes.....	B-25
Flight Software .....	B-25
Probe Flight System .....	B-25
Thermal Protection System .....	B-28
RF Communications .....	B-30
Probe Entry, Descent, and Landing (EDL).....	B-33
Concept of Operations.....	B-35
Mission Life-Cycle Costs .....	B-38
Mission Ground Rules and Assumptions .....	B-38
Instrument Costs.....	B-38
Costing Methodology and Basis of Estimate.....	B-40

WBS 01, 02, 03 Project Management, Systems Engineering, Mission Assurance (PM/SE/MA) .....	B-40
WBS 04 Science .....	B-41
WBS 05 Payload .....	B-41
WBS 06 Spacecraft.....	B-42
WBS 07 & 09 Mission Operations (MOps) & Ground Data Systems (GDS) (Phases A–D).....	B-43
WBS 08 Launch Vehicle and Services .....	B-43
WBS 10 System Integration & Testing (I&T).....	B-43
<b>APPENDIX C. REFERENCES.....</b>	<b>C-1</b>

# List of Figures

Figure 2.1. Number of fuel clads available (y-axis) versus year. ....	13
Figure 2.2. Mass (kg) delivered to Neptune orbit versus launch year. ....	14
Figure 2.3. Comparison of launch vehicle performance. ....	14
Figure 3.1. Data volume breakdown per instrument. ....	19
Figure 3.2. Orbiter and instrument configuration. ....	20
Figure 3.3. Descent module. ....	26
Figure 3.4. Odyssey’s 20-year journey and the locations of the planets during the time 2033–2053. ....	28
Figure 3.5. Odyssey’s 4-year tour of Neptune and Triton (Triton orbit is shown in black, and the axes are in units of Neptune radii). ....	29
Figure 3.6. Ground coverage achieved by Odyssey at Triton, colored by light level (time of day) (top) and distance from the surface (bottom). ....	30
Figure 3.7. Probe trajectory and concept of operations. ....	32
Figure 5.1. Mission cost comparison to other Flagship missions, excluding launch vehicle costs (in billions of FY25 dollars). ....	35
Figure 5.2. Cost risk analysis results (S curve) for Neptune mission, Phases A–F. ....	37
Figure B.1. Summary of orbiter payload heritage. ....	B-4
Figure B.2. Notional depiction of the probe instruments. ....	B-14
Figure B.3. Spacecraft size and fit into Falcon fairing. Spacecraft easily fits into SLS Block 2 fairing. ....	B-20
Figure B.4. Flight system block diagram. ....	B-21
Figure B.5. Atmospheric probe block diagram. ....	B-27
Figure B.6. Odyssey HEEET TPS thickness shown with loom weaving capabilities. ....	B-30
Figure B.7. Telecommunications subsystem block diagram (orbiter). ....	B-30
Figure B.8. Cumulative transmitted probe data for a single channel as a function of time after atmospheric entry. ....	B-31
Figure B.9. Descent module. ....	B-32
Figure B.10. Summary schedule. ....	B-37

# List of Tables

Table 1.1. Mission goals. ....	1
Table 2.1. Mission design table. ....	11
Table 3.1. Neptune Odyssey orbiter instrument payload (includes mission/instrument heritage, TRL, mass, power, and cost). Small discrepancies from Table B.4 are due to contingency margin. ....	17
Table 3.2. Neptune Odyssey probe instrument payload (includes mission/instrument heritage, TRL, mass, power, and cost). ....	18

Table 3.3. Neptune Odyssey system mass summary. ....	20
Table 3.4. Neptune Odyssey flight system dry mass summary. ....	20
Table 3.5. Summary of fuel requirements as a function of mission stage. ....	21
Table 3.6. $\Delta$ -V summary table by phase. ....	31
Table 3.7. Odyssey risk list. ....	32
Table 3.8. Odyssey risk matrix. ....	33
Table 4.1. Key phase duration table. ....	33
Table 5.1. Estimated cost of Neptune Odyssey mission (in thousands of FY25 dollars). ....	35
Table 5.2. Neptune mission confidence levels, based on cost risk analysis. ....	37
Table B.1. Concept maturity level definitions. ....	B-1
Table B.2. Mission element summary (mass, power, LV, tour and cost). ....	B-1
Table B.3. Orbiter instrument payload “plain English” descriptrs. ....	B-2
Table B.4. Heritage Instrument List and Properties. ....	B-3
Table B.5. Orbiter – Color Narrow-Angle Camera. ....	B-5
Table B.6. Orbiter – UV Imaging Spectrograph. ....	B-5
Table B.7. Orbiter – Vis-NIR Imaging Spectrometer. ....	B-6
Table B.8. Orbiter – Thermal IR Imager. ....	B-6
Table B.9. Orbiter – Ion and Neutral Mass Spectrometer. ....	B-7
Table B.10. Orbiter – Thermal Plasma Spectrometer - Ions. ....	B-7
Table B.11. Orbiter – Thermal Plasma Spectrometer - Electrons. ....	B-8
Table B.12. Orbiter – Energetic Particles Detector. ....	B-8
Table B.13. Orbiter – Energetic Neutral Atom Imager. ....	B-9
Table B.14. Orbiter – Laser Altimeter. ....	B-9
Table B.15. Orbiter – Radio and Plasma Wave Detector. ....	B-10
Table B.16. Orbiter – 3D Vector Magnetometer. ....	B-10
Table B.17. Orbiter – Microwave Radiometer. ....	B-11
Table B.18. Orbiter – ToF Dust Spectrometer. ....	B-11
Table B.19. Orbiter – EPO Camera. ....	B-12
Table B.20. Probe instrument summary. ....	B-12
Table B.21. Probe – Mass Spectrometer. ....	B-14
Table B.22. Probe – Helium Abundance Detector. ....	B-14
Table B.23. Probe – Atmospheric Structure Instrument. ....	B-15
Table B.24. Probe – Ortho-Para H <sub>2</sub> Detector. ....	B-15
Table B.25. Probe – Nephelometer. ....	B-16
Table B.26. Probe – Net Flux Radiometer. ....	B-16
Table B.27. Probe – Public Engagement Camera. ....	B-16
Table B.28. Doppler Wind Experiment. ....	B-17

<b>Table B.29. Data volume summary per instrument. ....</b>	<b>B-17</b>
<b>Table B.30. Summary of flight system characteristics. ....</b>	<b>B-19</b>
<b>Table B.31. Flight system power modes.....</b>	<b>B-25</b>
<b>Table B.32. Probe mass summary.....</b>	<b>B-28</b>
<b>Table B.33. Entry parameters, environments, and Heatshield for Extreme Entry Environment Technology (HEEET) sizing. ....</b>	<b>B-29</b>
<b>Table B.34. Mission Operations and Ground Data Systems Table.....</b>	<b>B-35</b>
<b>Table B.35. Estimated cost of orbiter payloads (in thousands of FY25 dollars). ....</b>	<b>B-39</b>
<b>Table B.36. Estimated cost of probe payloads (in thousands of FY25 dollars). ....</b>	<b>B-40</b>



# Executive Summary

The Neptune Odyssey mission concept is a Flagship-class orbiter and atmospheric probe to the Neptune-Triton system. This bold mission of exploration would be the first to orbit an ice giant planet to study the planet, its rings, small satellites, space environment, and the planet-sized moon, Triton. Triton is itself a captured dwarf planet from the Kuiper Belt and a geophysically reactivated twin of Pluto. Odyssey addresses Neptune system-level science, with equal priorities placed on Neptune, its rings, moons, space environment, and Triton. Between Uranus and Neptune, the latter is unique in providing simultaneous access to both an ice giant and a Kuiper Belt dwarf planet. The spacecraft—in a class with Cassini—would launch in 2033 on a Space Launch System (SLS) or equivalent launch vehicle on a 16-year cruise to Neptune for a 4-year prime orbital mission. The defined solution provides annual launch opportunities and allows for easy upgrade to a shorter (12-year) cruise phase that can utilize a Jupiter gravity assist (JGA), if NASA chooses to stand up this mission in time for a launch before 2032. Odyssey would orbit Neptune retrograde (prograde with respect to Triton), providing New Horizons-quality science from Triton every month, using the moon’s gravity to shape the orbital tour and allow coverage of a range of latitudes and longitudes on Triton, on Neptune, and in the space environment. The atmospheric entry probe would descend in ~37 minutes to the 10-bar pressure level in Neptune’s atmosphere just before Odyssey’s orbit-insertion engine burn. Odyssey’s mission would end by conducting a Cassini-like Grand Finale tour, passing inside the rings very close to the giant planet, and ultimately taking a final great plunge into Neptune’s atmosphere.

The mission is motivated by 5 Mission Goals: (1) How do the interiors and atmospheres of ice giant (exo)planets form and evolve? (2) What causes Neptune’s strange magnetic field, and how do its magnetosphere and aurora work? (3) Is Triton an ocean world? What causes its plumes? What is the nature of its atmosphere? (4) How can Triton’s geophysics and composition expand our knowledge of dwarf planets like Pluto? (5) What are the connections between Neptune’s rings, arcs, surface weathering, and small moons (some of which are captured from the Kuiper Belt or the protoplanetary disk)? As part of defining the science traceability matrix (STM) a family of instruments for both the orbiter and the probe were selected, drawing from proven flight heritage designs.

We present the mission concept as a “shovel-ready” concept maturity level of 4 and a total modeled cost (including 50% margin) of less than \$3.4B; this is a mission NASA could choose to stand up now without waiting for significant advances in technology. An SLS rocket with a Centaur upper stage (fitting in the payload fairing) allows direct-to-Neptune launch opportunities every calendar year. The spacecraft would launch with 3816 kg to Neptune orbit and utilize three RTGs (radioisotope thermoelectric generators), requiring 28.8 kg of plutonium. A JGA, although enhancing, is not required. If NASA selects a mission like Odyssey for a new start and an SLS-class vehicle is not available, a Falcon Heavy-class vehicle could deliver the same payload mass using a solar electric propulsion kickstage.

From the start of this long mission, preserving knowledge and cultural continuity would be a priority. Observations along the way (for example, stereo observations of the edges of our heliosphere, asteroid and Centaur flybys, and using Odyssey’s cameras for a rear-view look back at our solar system) will sustain interest and provide unprecedented opportunities for discovery. Finally, equipping both the orbiter and probe with cameras specially purposed for public engagement will help to share the joy of exploration and discovery with those who help make space exploration possible—the general public.

# NEPTUNE ODYSSEY

## ICE GIANT KUIPER BELT SYSTEM SCIENCE

- 1 How do the interiors and atmospheres of ice giant [exo]planets form and evolve?
- 2 What causes Neptune's strange magnetic field, and how do its magnetosphere and aurorae work?
- 3 Is Triton an ocean world? What causes its plumes? What is the nature of its atmosphere?
- 4 How can Triton's geophysics and composition expand our knowledge of dwarf planets like Pluto?
- 5 What are the connections between Neptune's rings, arcs, surface weathering, and small moons?

### COST:

<\$3.5 Billion

### POWER AT LAUNCH:

1087 W from 3 Next-Gen RTGs

### WET MASS AT LAUNCH

3816 kg

PROTEUS



ORBITING  
2049-2053

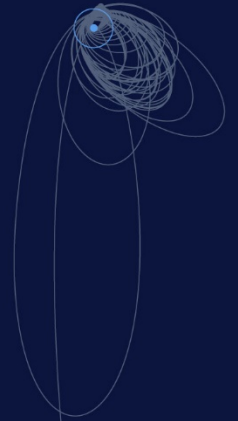

16 YEARS

DIRECT TO NEPTUNE

Small Body Observations  
Heliospheric Science

TRITON



## SCIENCE INSTRUMENTS

### ORBITER

- UV Imaging Spectrograph
- Color Narrow Angle Camera
- Vis-NIR Imaging Spectrometer
- Thermal IR Imager
- Ion and Neutral Mass Spectrometer
- Laser Altimeter
- Thermal Plasma Spectrometer
- Energetic Charged Particle Detector
- Energetic Neutral Atom Imager
- Radio & Plasma Wave Detector
- Magnetometer
- Microwave Radiometer
- Public Engagement Camera
- Dust Detector
- Gravity Investigation

### ENTRY PROBE

- Mass Spectrometer
- Atmospheric Structure Instrument
- Helium Abundance Detector
- Ortho-Para H<sub>2</sub> Detector
- Nephelometer
- Net Flux Radiometer
- Doppler Wind Experiment
- Public Engagement Camera

Centaur  
Upper Stage

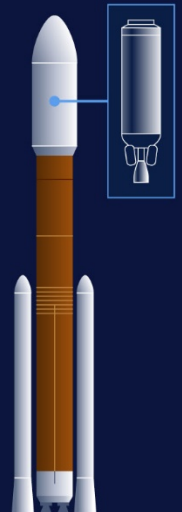

SLS BLOCK 2  
LAUNCH 2033

# 1. Scientific Objectives

Five Mission Goals were identified from which the STM and instrument selection flow:

- How do the interiors and atmospheres of ice giant (exo)planets form and evolve?
- What causes Neptune’s strange magnetic field, and how do its magnetosphere and aurorae work?
- Is Triton an ocean world? What causes its plumes? What is the nature of its atmosphere?
- How can Triton’s geophysics and composition expand our knowledge of dwarf planets like Pluto?
- What are the connections between Neptune’s rings, arcs, surface weathering, small moons and captured Kuiper Belt objects? Entry probe measurements are the most challenging from a time-critical perspective.

## Science Traceability Matrix

Table 1.1 provides a summary of the five Mission Goals and associated instruments. The full STM (p2-4) includes colored boxes indicating how the “science objectives” map to these goals.

**Table 1.1. Mission goals.**

	Color Narrow-Angle Camera	UV Imaging Spectrograph	Thermal IR Mapping Radiometer	Laser Altimeter	Vis-NIR Imaging Spectrometer	Microwave Radiometer	Magnetometer	Radio and Plasma Waves	Mass Spectrometer	Thermal Plasma	Energetic Particles	Energetic Neutral Atom Camera	Dust Analyzer	Public Eng. Camera	Atmospheric Probe	Radio/Gravity Science
<b>1. ORIGINS</b> How do the interiors and atmospheres of ice giant (exo)planets form and evolve?	1	1	1		1	2	1	2		2	2				1	1
<b>2. MAGNETICS</b> What causes Neptune’s strange magnetic field, and how do its magnetosphere and aurora work?	2	1	2		2	2	1	1		1	1	2			2	1
<b>3. OCEAN WORLDS</b> Is Triton an ocean world? What causes its plumes? What is the nature of its atmosphere?	1	2	2	2	1		1	2	1	2	2	2	2			2
<b>4. COMPARITIVE PLANETOLOGY</b> How can Triton’s geology, geophysics, and composition expand our knowledge of dwarf planets like Pluto?	1	2	2	2	1		2		2				2			1
<b>5. SATELLITE AND RING SYSTEMS</b> What are the origins of and connections between Neptune’s rings, arcs, surface weathering, and small moons?	1	2		2	1		2	2	2	1	1		2			

Key: 1 = required to fulfill goal; 2 = Supports fulfilling goal



# Science Traceability Matrix

1. ORIGINS	2. MAGNETICS	3. OCEAN WORLDS	4. COMPARATIVE PLANETOLOGY	5. SATELLITE and RING SYSTEMS
------------	--------------	-----------------	----------------------------	-------------------------------

Scientific Objective		Measurement	Instrument	Functional requirement (e.g. trajectory, pointing)
1	<b>N1. BULK COMPOSITION</b> Determine the bulk composition of Neptune.	In situ measurement of noble-gas abundance (He, Kr, Xe, and Ar) and isotopic ratios of key elements (C, H, O, N, Kr, Xe, and Ar). Threshold: 1-bar (Can measure all noble gases and C, but not deep enough to measure S, N, or O) Baseline: 10-bar (deep enough for S and N, but not O)	Mass Spectrometer (all species), Helium Abundance Detector on Entry Probe	Probe sends data to orbiter; orbiter needs to be within line of sight and relatively close to Probe Entry Location during entry & descent lasting for up to 60 min.
		Measurement of C, N, S, O; P, As, Ge abundances, and He Threshold: 5-bar (below suspected CH <sub>4</sub> cloud) Baseline: 10-bar (below suspected H <sub>2</sub> S clouds)	Mass Spectrometer on Entry Probe (all species), Microwave Radiometer (N, S, O, P), Vis-NIR Imaging Spectrometer (all except O), Thermal IR Imager (for He)	Probe sends data to orbiter; orbiter needs to be within line of sight and relatively close to Probe Entry Location during entry & descent lasting for up to 60 min.
1	<b>N2. INTERNAL STRUCTURE and INTERNAL ROTATION RATE</b> Constrain the structure and characteristics of the planet's interior, including layering, locations of convective and stable regions, and internal dynamics.	Low degree (≤8) gravitational moments through observations of perturbations to spacecraft orbit.	Gravity Investigation	Close periapse passes (within 1.1 Neptune radii) and high-inclination orbits. Ideally have closest approaches that span a wide latitudinal and longitudinal range. High-gain antenna must be Earth-pointed.
		Intrinsic magnetic field up to spherical harmonic degree 10 and its temporal variability.	Magnetometer	
		Kilometric radio emission period, magnetic rotation rate.	Radio & Plasma Wave Detector, Magnetometer	Close periapse passes (within 1.51 planetary radii). Large-scale coverage in planetary longitude and latitude (latitude or longitude coverage of at least 45° in one direction along with coverage of the full planet in the other direction), and time.
1	<b>N3. GLOBAL ENERGY BALANCE and ATMOSPHERIC ENERGY FLUX</b> Measure Neptune's atmospheric energy balance as a function of latitude, and altitude. Understand roles of various processes that redistribute energy in altitude and latitude from the troposphere to the thermosphere.	Visible to IR bond albedo via 0.4–4 μm imaging spectroscopy with spatial resolution on the scale of the narrow bands (i.e., few hundred km).	Vis-NIR Imaging Spectrometer	Sample reflectivity over (i) the full range of phase angles, particularly from the nadir to the terminator, and (ii) temporal variability in the reflectivity.
		Thermal emission Baseline: 5 μm to ~1 mm radiometer	Thermal IR Imager	Full-disk day- and nightside views, plus latitudinally resolved views.
		Spatial distribution and morphology of clouds and aerosols.	Color Narrow Angle Camera, Vis-NIR Imaging Spectrometer	Global dayside coverage with 30 km/pixel resolution from multiple phase angles < 90°.
		Occultations for stratosphere and above.	UV Imaging Spectrograph (solar and stellar occultations), Vis-NIR Imaging Spectrometer, Radio occultation (USO on orbiter preferred)	Close periapse passes: - For Solar and radio occultations, periapsis probably needs to be on nightside. - For radio occultations, high-gain antenna must be Earth-pointed; sample latitudes as possible (ingress and egress). - For Stellar occultation, a bright star must go behind the planet.
		Ground-truth in situ measurements of vertical energy flux and composition, Condensable Species distribution, and Disequilibrium Species.	Net Flux Radiometer, Nephelometer, Mass Spectrometer, Ortho-Para H <sub>2</sub> Detector on Entry Probe	Probe send data to orbiter; orbiter needs to be within line of sight and relatively close to Probe Entry Location during entry & descent lasting for up to 60 min.
1	<b>N4. DYNAMO</b> Determine the configuration and temporal evolution of the intrinsic magnetic field.	Intrinsic magnetic field up to spherical harmonic degree 10 and its temporal variability.	Magnetometer	Close periapse passes (within 1.51 planetary radii). Large-scale coverage in planetary longitude and latitude (latitude or longitude coverage of at least 45° in one direction along with coverage of the full planet in the other direction), and time.
		Remote sensing of magnetic field footprint via auroral radio emission.	Radio & Plasma Wave Detector	Close periapse passes. Large-scale coverage in planetary longitude and latitude, and time.
		Remote sensing of magnetic field footprint via UV and IR emission from auroral and satellite footprints.	UV Imaging Spectrograph, Vis-NIR Imaging Spectrometer	Planet-pointing.
1	<b>N5. METEOROLOGY, CIRCULATION, AEROSOLS, and CHEMISTRY</b> Determine the 3D atmospheric circulation (zonal, meridional, vertical) and temperature structure. Determine how dynamics, cloud chemistry, and moist convection drive temporal and spatial variabilities in composition and circulation. Determine the role of dynamics and composition in the formation and evolution of Neptune's aerosols and discrete meteorological features (e.g., storms, vortices). Determine the effects of seasonal changes in insolation. Establish the coupling between tropospheric phenomena and stratospheric circulation via measurements of wave propagation and contrasts in temperature/composition (e.g., particularly associated with Neptune's seasonal polar vortex). Search for evidence for, and potentially map the distribution of,	Spatial distribution, morphology, and scattering properties of clouds and aerosols, cloud-tracing wind measurements.	Color Narrow Angle Camera, Thermal IR Imager, Vis-NIR Imaging Spectrometer, UV Imaging Spectrograph	Global dayside coverage with 30-km/pixel resolution from multiple phase angles < 90°. Repeat global coverage at least once a year. Feature tracking from nadir to limb. Limb has to be visible in each image to allow high-precision navigation. For wind measurements, visible and near-IR (methane band) images with 30 km/pixel resolution, taken in pairs separated in time by hours and by one planetary rotation at a range of phase angle up to 90°.
		Search for evidence of lightning.	Radio & Plasma Wave Detector	Optical detection requires nightside observations.
		In situ measurements of vertical radiative energy flux, lapse rate, cloud properties, vapor abundances, and winds. Threshold: 5-bar / Baseline: 10-bar (below sunlight penetration)	Net Flux Radiometer, Nephelometer, Mass Spectrometer, Ortho-Para H <sub>2</sub> Detector, USO (Doppler Wind Experiment), Atmospheric Structure Instrument on Entry Probe	Probe send data to orbiter; orbiter needs to be within line of sight and relatively close to Probe Entry Location during entry & descent lasting for up to 60 min.
		Latitudinally resolved (1000 km spatial res) distribution of disequilibrium chemical tracers of motions in the troposphere and stratosphere (para-H <sub>2</sub> , CO, C <sub>2</sub> H <sub>6</sub> , C <sub>2</sub> H <sub>2</sub> , and – if detected – PH <sub>3</sub> , GeH <sub>4</sub> , AsH <sub>3</sub> ).	Vis-NIR Imaging Spectrometer, Thermal IR Imager	If we use OVIRS-type point-spectrometer instrument, the camera must raster-scan the target or requires a scan platform to construct an image.
		Depth of zonal winds and other detectable weather patterns.	Gravity Investigation, Doppler Wind Experiment	Close periapse passes (within 1.1 Neptune radii) and high-inclination orbits. Ideally have closest approaches that span a wide latitudinal and longitudinal range. High-gain antenna must be Earth-pointed.
		Tropospheric condensable volatiles (CH <sub>4</sub> , NH <sub>3</sub> , H <sub>2</sub> S, possibly H <sub>2</sub> O) as a function of latitude, altitude, and time (for atmospheric chemistry and as tracers of motion).	Vis-NIR Imaging Spectrometer, Microwave Radiometer	Must scan the disk to construct an image – adds pointing requirement. Repeat measurements at least once per year.
Distribution and variability of exogenic species falling into Neptune's atmosphere (e.g., H <sub>2</sub> O, CO, HCN, CH <sub>4</sub> ), for atmospheric chemistry and circulation.	Vis-NIR Imaging Spectrometer	Point-spectrometer instrument must raster-scan the target or requires a scan platform.		

# Science Traceability Matrix

1. ORIGINS	2. MAGNETICS	3. OCEAN WORLDS	4. COMPARATIVE PLANETOLOGY	5. SATELLITE and RING SYSTEMS
------------	--------------	-----------------	----------------------------	-------------------------------

Scientific Objective	Measurement	Instrument	Functional requirement (e.g. trajectory, pointing)
previously undetected stratospheric species as tracers of neutral and ion chemistry in Neptune's middle and upper atmosphere. Determine if/how exogenic oxygen species influence stratospheric chemistry.	3D temperature structure, and static stability of the atmosphere. Include temperature contrasts associated with discrete vortices, storm features, and waves. Cover thermosphere, stratosphere, and troposphere.A1	Vis-NIR Imaging Spectrometer, Thermal IR Imager, UV Imaging Spectrograph, Gravity Investigation	Remote sensing: Orbits that allow global mapping of both day- and nightside, feature tracking from nadir to limb. For radio occultation: Close periapse passes – periapsis need to be on nightside – high-gain antenna must be Earth-pointed, repeat measurements for multiple latitudes – every 10° in latitude. For stellar+solar occultations: Close periapse passes – for Solar occultation, periapsis need to be on night side. For Stellar occultation, periapsis orientation doesn't matter ... we need a bright star go behind the planet. Repeat global coverage at least once a year.
<div style="background-color: #d4edda; padding: 2px;">1</div> <div style="background-color: #fff3cd; padding: 2px;">2</div> <p><b>N6. THERMOSPHERIC and IONOSPHERIC PROCESSES, AURORAL DRIVERS and VARIABILITY</b> Determine whether auroral precipitation or infalling equatorial plasma and neutral material from the surrounding space environment affect the composition or temperature of the thermosphere and stratosphere.</p>	Monitor the evolution of auroral emissions (UV, visible/IR/radio).	UV Imaging Spectrograph, Color Narrow Angle Camera, Vis-NIR Imaging Spectrometer, Radio & Plasma Wave Detector, Energetic neutral atom (ENA) imager	Planet-pointing on night side. Pointing stability should be high enough for long exposure needed to image faint aurora emissions. Need dayside and nightside spectra.
	Stratosphere to thermosphere/ionosphere temperature and composition.	Vis-NIR Imaging Spectrometer, Thermal IR Imager	Planet-pointing night side global imaging. Point-spectrometer instrument must raster-scan the target or requires a scan platform.
	Characterize the auroral drivers (in situ particles and fields).	Magnetometer, Radio and plasma wave instrument, Thermal plasma spectrometer, Energetic particle instrument	Some close high latitude Neptune flybys.
	Thermosphere atmospheric density as function of altitude through probe deceleration measurement during atmospheric entry.	Atmospheric Structure Instrument on Entry Probe	Probe sends data to orbiter; orbiter needs to be within line of sight and relatively close to Probe Entry Location during entry & descent lasting for up to 60 min.
<div style="background-color: #d4edda; padding: 2px;">1</div> <div style="background-color: #fff3cd; padding: 2px;">2</div> <div style="background-color: #fff3cd; padding: 2px;">3</div> <div style="background-color: #fff3cd; padding: 2px;">4</div> <div style="background-color: #fff3cd; padding: 2px;">5</div> <p><b>N7. MAGNETOSPHERIC STRUCTURE and DYNAMICS</b> Characterize and determine the spatial distribution and variability of magnetospheric plasma, radiation belts and current systems.</p>	Measure magnetospheric plasma sources and losses and characterize the planetary radiation belts. Measure the energy, angular, and compositional distributions of thermal and energetic plasma versus location and their variability with time. Measure the vector magnetic field and the power and spectrum of electromagnetic waves versus location and their variability with time. Image the auroral (UV, IR?, Vis?) and ENA emissions.	Thermal plasma, Energetic particles, Vector magnetometer, Radio Plasma Wave Instrument, UV spectrometer, IR spectrometer? Visible camera or spectrometer? Energetic neutral atom (ENA) imager	Large-scale coverage in radial distance, planetary longitude and latitude. Need to get multiple crossings of magnetopause (~20–25 RN? dayside) to investigate losses. Need to get at least 5 orbits with apoapsis in the magnetotail - say w/in 15 Rn of Sun-Neptune line and >50 Rn downtail (anti-sunward of Neptune). Would like periapsis as close as possible (definitely within 10 Rn). Large-scale coverage in radial distance, planetary longitude and latitude. High altitude, to look back at system. Need orbit highly inclined relative Triton orbital plane to image potential torus.
	Determine Triton's 3D shape to 1 km accuracy per axis. Measure Neptune's magnetic field upstream/local to Triton, and fully characterize the time-dependent variability (14 & 141 hr periodicity signals). At the closest approach to Triton measure the amplitude ratio of the secondary (induced field) to the primary field. Measure the upstream plasma density and energy to quantify the plasma interaction, and where possible Triton's ionospheric density profile. Need to resolve on the order of 0.05–0.1 nT to determine total ice shell thickness to ± 20% [2]. Measure Triton's low degree static gravity coefficients to determine the ice shell thickness to ±20% and to determine whether the ice shell is in hydrostatic equilibrium. TRITON STRUCTURE: Measure Triton's internal Love number $k_2 < 0.06$ . Both X- and Ka-band to help cancel terrestrial ionospheric fluctuation noise.	Color Narrow Angle Camera, Fluxgate magnetometer, Radio/Gravity science subsystem, Laser Altimeter, UV Imaging Spectrograph.	Image Triton's Sun-illuminated disc at <90° phase angle in visible or NIR wavelengths (~0.4–1 μm) from >3 evenly spaced sub-spacecraft lon/lat on Triton at 1–10 km/pixel, SNR and Dynamic Range >100. Combine with visible stellar occultation measurements at >3 points in spacecraft and Triton's orbits. At least 16 encounters (one for DC field plus three per induced frequency) with a closest approach below 380 km (2°0.333 from body center). These encounters should be distributed over the phase of the driving frequencies, with no gaps greater than 45° in phase for each frequency. The phase of each frequency is defined as (t/P MOD 1)*360, where P = {141.0, 16.1, 14.5, 13.1, 7.2} hr. High-gain antenna to Earth; lidar to nadir (preferable). High-resolution (10s m/pixel), close flyby imaging. Need ranges at ~50 ground-track intersections. Two-way coherent Doppler tracking (< 0.1 mm/s for 60-s count time) when Sun-Earth-Probe angle (SEP) > 10°. Repeated images of the same point at multiple True Anomalies.
<div style="background-color: #fff3cd; padding: 2px;">3</div> <div style="background-color: #d4edda; padding: 2px;">4</div> <p><b>T1. TRITON SHAPE, STRUCTURE, AND OCEAN</b> Determine whether Triton's ice shell is in hydrostatic equilibrium and decoupled; measure induced magnetic field; Map gravity field</p>	Measure surface geological and composition properties; spatial-temporal temperature changes; atmospheric isotopic composition. Better than 3 km/pixel. Composition and images of plumes and deposits. Image southern hemisphere at resolutions equivalent to Voyager (1 - 5 km) in order to look for changes in plume existence, size and/or location.	Multispectral Vis-NIR Imaging Spectrometer, UV imaging spectrograph, Narrow angle camera, Mass spectrometer	Map all available illuminated terrain (i.e. not in polar night) with 12 flybys to better than 3 km/pixel. Passes should be spaced ~30° in longitude, with phase angle <45°, at an altitude <100,000 km. Tour must be flexible to return to location of any new plumes detected at an altitude of <20,000 km, phase angle <30°. Very close Triton flyby through extended upper atmosphere. Mass spectrometer to (near) ram, imaging spectrometer near nadir. If/when plumes are located image the source at a resolution of 100 m or better acquire spectra of plume material at res of 2 km or better.
	Measure the temporal variability of atmospheric composition. Measure the atmospheric pressure and temperature from the base to the thermosphere, and as a function of local time. Measure the atmospheric escape rate. Search for and map surface telltales of atmospheric seasonal variability, such as wind streaks and seasonal layering. Map atmospheric transport; gas and haze composition/evolution; atmospheric pressure, temperature, and spatial-temporal variation. Map distribution of volatiles in order to map polar cap boundaries.	Ion Mass Spectrometer, UV Imaging Spectrometer, Mass Spectrometer, Color Narrow Angle Camera, Radio Science	Mass spectrometer to (near) ram, ~few hundred km altitude. Phase angles to at least 150°, ~few hundred km altitude. 6–12 solar and stellar occultations distributed in latitude and (for the stellar occultations) in local time of day. At least 2 mass spec sampling approaches ~few hundred km altitude; more highly desired. 6–12 solar and stellar occultations distributed in latitude and (for the stellar occultations) in local time of day. At least 2 mass spec sampling approaches ~few hundred km altitude; more highly desired.
<div style="background-color: #fff3cd; padding: 2px;">3</div> <div style="background-color: #d4edda; padding: 2px;">4</div> <p><b>T2. TRITON SURFACE AND PLUMES</b> Characterize the surface and look for changes, including plumes and their composition</p>	Measure the flow of plasma density, energy spectrum, flux, and composition around Triton for ions and electrons. Measure the electron density and the composition of the ionosphere, and how these vary with local/diurnal time. Measure the interaction of Triton with Neptune's magnetosphere including electric currents and electron beams, either directly or through beam-generated plasma waves.	Ion Neutral Mass Spectrometer, Thermal plasma spectrometer. Energetic particle instrument, Magnetometer, Plasma wave instrument.	Mass spectrometer to (near) ram, ~few hundred km altitude. Particle instruments need instrument pointing parallel, anti-parallel and perpendicular to magnetic field.
	Measure the temporal variability of atmospheric composition. Measure the atmospheric pressure and temperature from the base to the thermosphere, and as a function of local time. Measure the atmospheric escape rate. Search for and map surface telltales of atmospheric seasonal variability, such as wind streaks and seasonal layering. Map atmospheric transport; gas and haze composition/evolution; atmospheric pressure, temperature, and spatial-temporal variation. Map distribution of volatiles in order to map polar cap boundaries.	Ion Mass Spectrometer, UV Imaging Spectrometer, Mass Spectrometer, Color Narrow Angle Camera, Radio Science	Mass spectrometer to (near) ram, ~few hundred km altitude. Phase angles to at least 150°, ~few hundred km altitude. 6–12 solar and stellar occultations distributed in latitude and (for the stellar occultations) in local time of day. At least 2 mass spec sampling approaches ~few hundred km altitude; more highly desired. 6–12 solar and stellar occultations distributed in latitude and (for the stellar occultations) in local time of day. At least 2 mass spec sampling approaches ~few hundred km altitude; more highly desired.
<div style="background-color: #fff3cd; padding: 2px;">3</div> <div style="background-color: #d4edda; padding: 2px;">4</div> <p><b>T3. TRITON ATMOSPHERE</b> Measure and map atmospheric composition, temperature, and pressure</p>	Measure the flow of plasma density, energy spectrum, flux, and composition around Triton for ions and electrons. Measure the electron density and the composition of the ionosphere, and how these vary with local/diurnal time. Measure the interaction of Triton with Neptune's magnetosphere including electric currents and electron beams, either directly or through beam-generated plasma waves.	Ion Neutral Mass Spectrometer, Thermal plasma spectrometer. Energetic particle instrument, Magnetometer, Plasma wave instrument.	Mass spectrometer to (near) ram, ~few hundred km altitude. Particle instruments need instrument pointing parallel, anti-parallel and perpendicular to magnetic field.
	Measure the flow of plasma density, energy spectrum, flux, and composition around Triton for ions and electrons. Measure the electron density and the composition of the ionosphere, and how these vary with local/diurnal time. Measure the interaction of Triton with Neptune's magnetosphere including electric currents and electron beams, either directly or through beam-generated plasma waves.	Ion Neutral Mass Spectrometer, Thermal plasma spectrometer. Energetic particle instrument, Magnetometer, Plasma wave instrument.	Mass spectrometer to (near) ram, ~few hundred km altitude. Particle instruments need instrument pointing parallel, anti-parallel and perpendicular to magnetic field.
<div style="background-color: #fff3cd; padding: 2px;">3</div> <div style="background-color: #d4edda; padding: 2px;">4</div> <p><b>T4. TRITON ENERGY FLUX AND NEPTUNE INTERACTION</b> Measure plasma processes and charged particle composition and magnetic fields</p>	Measure the flow of plasma density, energy spectrum, flux, and composition around Triton for ions and electrons. Measure the electron density and the composition of the ionosphere, and how these vary with local/diurnal time. Measure the interaction of Triton with Neptune's magnetosphere including electric currents and electron beams, either directly or through beam-generated plasma waves.	Ion Neutral Mass Spectrometer, Thermal plasma spectrometer. Energetic particle instrument, Magnetometer, Plasma wave instrument.	Mass spectrometer to (near) ram, ~few hundred km altitude. Particle instruments need instrument pointing parallel, anti-parallel and perpendicular to magnetic field.
	Measure the flow of plasma density, energy spectrum, flux, and composition around Triton for ions and electrons. Measure the electron density and the composition of the ionosphere, and how these vary with local/diurnal time. Measure the interaction of Triton with Neptune's magnetosphere including electric currents and electron beams, either directly or through beam-generated plasma waves.	Ion Neutral Mass Spectrometer, Thermal plasma spectrometer. Energetic particle instrument, Magnetometer, Plasma wave instrument.	Mass spectrometer to (near) ram, ~few hundred km altitude. Particle instruments need instrument pointing parallel, anti-parallel and perpendicular to magnetic field.



## Science Traceability Matrix

1. ORIGINS	2. MAGNETICS	3. OCEAN WORLDS	4. COMPARATIVE PLANETOLOGY	5. SATELLITE and RING SYSTEMS
------------	--------------	-----------------	----------------------------	-------------------------------

Scientific Objective	Measurement	Instrument	Functional requirement (e.g. trajectory, pointing)
<div style="background-color: #d4edda; padding: 2px; display: inline-block; margin-bottom: 5px;">5</div> <p><b>S1. RINGS and other SATELLITES</b> Search for small and embedded moonlets, additional rings and arcs, as well as long-term variations in the ring structure</p>	Survey entire ring-moon system from Neptune's upper atmosphere out to the orbit of Triton at high and low phase angles and search for additional clumps and moons that are at least 100 m wide.	Color Narrow Angle Camera	Survey all longitudes of rings and arcs with <10–100 km/pixel resolution <60° and >140°.
<div style="display: flex; gap: 5px;"> <div style="background-color: #f8d7da; padding: 2px; display: inline-block;">1</div> <div style="background-color: #fff3cd; padding: 2px; display: inline-block;">2</div> <div style="background-color: #d4edda; padding: 2px; display: inline-block;">5</div> </div> <p><b>S2. VARIATIONS IN RING STRUCTURE</b> Identify influences from resonances with satellites &amp; planet in rings</p>	Survey all longitudes in the rings multiple times over a period of years to look for changes in the rings. Observe full orbital period of ring particles in the Adams and Le Verrier rings. Repeated observations of same region for all rings for long-term changes. High-resolution imaging of selected ring features.	Color Narrow Angle Camera	Images with <10–100 km/pixel resolution, phase angles <60° and >140° are particularly useful. Images with spatial resolution of <2 km/pixel and all other rings at <50 km/pixel. Cadence of imaging better than 1 month Resolution better than 2 km
<div style="display: flex; gap: 5px;"> <div style="background-color: #f8d7da; padding: 2px; display: inline-block;">1</div> <div style="background-color: #fff3cd; padding: 2px; display: inline-block;">2</div> <div style="background-color: #d4edda; padding: 2px; display: inline-block;">5</div> </div> <p><b>S3. SATELLITE ORBITAL CONFIGURATION</b> Determine the current orbit configuration of the moons and how this evolved over time.</p>	Determine the astrometry of the small moons.	Color Narrow Angle Camera	Periodic observations over the course of several years
<div style="background-color: #d4edda; padding: 2px; display: inline-block; margin-bottom: 5px;">5</div> <p><b>S4. RING PARTICLE SIZE DISTRIBUTION</b></p>	Conduct radio occultations of Adams ring arcs.	Radio Science	High-gain antenna to Earth
	Measure diffraction signals and compare ring optical depths at multiple wavelengths during Stellar and Solar Occultations by the rings.	UV Imaging Spectrometer, Vis-NIR Imaging Spectrometer	Orbit tour gives occultation opportunities.
	Spectral and photometric measurements of fine particles.	Visible Camera, UV Imaging Spectrometer, Vis-NIR Imaging Spectrometer	Observe at phase angles > 140° to study dusty rings.
	Directly detect particles.	Dust Detector, Plasma Instrument	Obtain in situ measurements at multiple longitudes and altitudes above/below ring plane.
<div style="display: flex; gap: 5px;"> <div style="background-color: #f8d7da; padding: 2px; display: inline-block;">1</div> <div style="background-color: #fff3cd; padding: 2px; display: inline-block;">2</div> <div style="background-color: #d4edda; padding: 2px; display: inline-block;">5</div> </div> <p><b>S5. COMPOSITION AND SURFACE PROPERTIES</b> of the rings and moons</p>	Obtain spectral data on the rings to determine ring composition.	Vis-NIR Imaging Spectrometer, UV Imaging Spectrometer	Vis-NIR wavelength coverage up to 4 microns with R ~ 100, phase angles ranging from <1° to >70°. UV wavelength coverage down to 100 nm with spectral resolution < 5 nm at phase angles ranging from <1° to >70°.
	Obtain spatially resolved images on both the leading and trailing hemispheres of all known satellites. Compare hemispheres to look for leading-trailing asymmetries. Characterize the incident radiation environment.	Vis-NIR Imaging Spectrometer, UV Imaging Spectrometer, Thermal plasma spectrometer, Energetic particle instrument	Vis-NIR wavelength coverage up to 4 microns with R ~ 100, phase angles ranging from <1° to >70°. UV wavelength coverage down to 100 nm with spectral resolution < 5 nm at phase angles ranging from <1° to >70°.

## Science Closure

The team were organized into WGs to define the science case and necessary data and tour elements. Here we provide summaries of the science addressed and how this mission achieves science closure in each case organized by five goals (not ordered by priority) and guiding sub-questions; the STM science objectives to which the sub-questions map are included in parentheses (e.g., STM-N#). These topics are also covered in the PMCS presentation available at <https://www.youtube.com/watch?v=1NrYIVNvqLI&feature=youtu.be>.

### 1. Neptune (Ice Giant and Exoplanet) Origins

#### **What are the characteristics of the interiors and atmospheres of ice giant (exo)planets, and how do they form and evolve?**

The Odyssey mission's exploration of the planet Neptune will address overarching goals to understand the planet's origin and how it evolved, and to place it in context with other planetary types. We have identified six science objectives related to Neptune itself and its magnetic phenomena.

#### **Where, when, and how did Neptune form and migrate in the solar system? (STM-N1, -N2, and -N3)**

The single most important measurement to understand the formation of Neptune is the bulk abundance of [noble gases and their isotopic ratios](#)<sup>1</sup>, as well as the isotopic ratios of hydrogen, oxygen, carbon, and nitrogen. Odyssey achieves this with mass spectrometer measurements made from an in situ atmospheric probe with supporting atmospheric pressure, temperature, and helium abundance data down to a pressure of 10 bar. Furthermore, Odyssey will make gravity and magnetometer measurements to determine its [internal density structure](#)<sup>2</sup> and the location and nature of its magnetic-field-generating dynamo, providing clues as to its current interior structure, which constrains formation models. Similarly, the global energy balance of Neptune is also critical to understand its internal structure, both at present and over time.

#### **What processes govern the dynamics, chemistry, and evolution of ice giants? (STM-N3, -N4, -N5, -N6, and -N7)**

The thermal evolution of Neptune is central to understanding Neptune's overall evolution and the [driving forces](#)<sup>3</sup> of interior and [atmospheric dynamics](#)<sup>4</sup>. Odyssey's visible-wavelength cameras and thermal-IR bolometer will determine how much internal heat is being released in the present epoch, constraining processes such as the rain-out of carbon and atmospheric convection. [Neptune's dynamo](#)<sup>5</sup> will be characterized in detail during low periapse flybys. The same instruments can map locally where sunlight is deposited and where internal energy is released to indicate how internal dynamics distribute the incoming and outgoing energy. Vigorous convection and meridional circulation patterns also inform how internal dynamics distribute energy. Such patterns are identified by tracking clouds with visible and near-infrared (NIR) cameras, or the distribution of condensable or disequilibrium gases using a microwave sounder and IR spectrometer, or secular variation from magnetometer measurements). Gravity measurements near Neptune will also determine how deep the zonal winds extend into the planet and whether they interact with the dynamo. The planet's internal rotation rate will be refined primarily by a radio wave detector, which will also search for auroral footprints and lightning.

Neptune exhibits various types of observable changes beyond those associated with thermal evolution. The timescales of these changes vary from hours to decades. The changes are manifest by, for example, variations in zonal wind speeds, cloud/haze distribution, the gas abundance of condensable species, and formation and dissipation of the famous “Dark Spots.” To understand the role of various processes that drive the present-day phenomena (e.g., cloud microphysics, cumulus convection, atmospheric turbulence, radiative transfer/forcing, photochemistry, seasonally varying insolation), the Odyssey orbiter is equipped with a suite of remote-sensing instruments. Imaging cameras will record global distribution of clouds and hazes to determine their vertical layering via radiative transfer models. Cloud-tracking measurements will reveal the turbulent wind field. Ultraviolet (UV), visible, infrared spectrographs and the microwave radiometer will determine the three-dimensional distribution of various chemical species, such as disequilibrium species, to infer the meridional circulation and vertical mixing.

Odyssey’s suite of remote-sensing spectrometers will, by identifying the abundance and distribution of various species in the stratosphere and troposphere, as well as determining temperature profiles, provide information on the composition and chemistry of the observable atmosphere. This information not only provides clues about circulation patterns, as mentioned above, but also informs about the potential infall of material from the rings or the interplanetary environment, and—via chemical modeling—of the bulk composition of the planet.

The atmospheric probe provides ground-truth for all of the “processes” measurements discussed here, even though its measurements are made at only one point in the atmosphere. Its determination of temperature, composition, net flux, winds, and the hydrogen ortho-para ratio provide validation and a calibration point for all remote-sensing observations. Only one giant planet entry probe has been achieved in the 60+ years of planetary exploration. We will double that count, using much more capable instruments than the 1970s technology available to the Galileo probe at Jupiter.

### **How do ice giants differ from gas giants and super-Earths (STM-N-all)**

By understanding the formation and evolution of Neptune, and the present-day processes acting upon it, we gain insights into our own and other planetary systems. For example, identification of key physical processes such as planetary migration and moist convection in thick H<sub>2</sub>/He atmospheres would not have stemmed from Earth studies alone. By utilizing Neptune as a natural laboratory, we will learn about, and be better able to characterize, planetary types that may not exist in our solar system (e.g., super-Earths and sub-Neptunes).

## **2. Neptune’s Strange Magnetic Field and Magnetospheric Processes**

Neptune’s multipolar intrinsic magnetic field has no clear symmetries along any axis, and no information about secular variation is known at present. Although a convection-driven dynamo is widely agreed upon as the source of this field, the underlying reason why it is non-dipolar and non-axisymmetric remains poorly understood. Neptune’s magnetosphere is complex, with significant non-dipolar contributions, tilt, and offset from the planet’s center. These peculiarities, combined with Neptune’s relatively rapid rotational period, lead to widely varying configurations on diurnal and seasonal timescales. In particular, this dynamic behavior tests many precepts in the understanding of planetary magnetospheres. The case of Neptune is made even more intriguing by the presence of the captured dwarf planet Triton, a satellite slightly larger than Pluto with a collisional atmosphere, that might be an active ocean world. The study of Neptune’s aurora and mapping its magnetic

field are vital to understanding processes critical to the Neptune system, including exploring Triton's interactions and whether it contains a subsurface ocean via study of its auroral activity and magnetic induction using magnetic sounding techniques.

**What is the configuration of Neptune's intrinsic magnetic field and how does the dynamo operate? (STM-N1, -N2, -N3, -N4, and -N5)**

A pair of fluxgate magnetometers mounted along a 10.5-m boom will make continuous vector measurements of Neptune's magnetic field with sufficient temporal resolution and sensitivity to probe the internal structure of Neptune (and Triton) and will also investigate magnetospheric currents and dynamics. The Odyssey tour is designed to provide full coverage of Neptune's magnetic environment and will provide the first detailed configuration of an ice giant dynamo and magnetosphere. To determine the location and convective dynamics of the dynamo, the bulk composition, internal structure, global energy balance, interior circulations, and internal energy fluxes must also be investigated as described in the [1. Neptune \(Ice Giant and Exoplanet\)](#) Origins section above.

**How is the Neptunian magnetospheric current system configured? (STM-N4, -N6, -N7, and -T4)**

The magnetospheric investigations benefit from the planet's large dipole tilt and rapid rotation, which allows a spacecraft in a given orbital plane to sample a large range of magnetic latitudes over diurnal timescales. Precession of the Odyssey orbit over the duration of the baseline mission enables comprehensive coverage of all magnetic local times, with multiple chances to investigate solar wind-coupling on the dayside and plasma transport processes in the nightside magnetotail.

**How is plasma sourced, transported, and lost within the Neptunian magnetosphere? Can Neptune develop and sustain significant radiation belts? What drives the aurora? (STM-N4, -N6, -N7, -T4, and -S5)**

Neptune's magnetosphere was observed to contain heavy ions, and it has been suggested that these might be nitrogen coming from Triton—possibly from a neutral torus sourced from Triton. However, given the apparent quiescence of the system, how that torus may be formed and how the resulting particles are transported remain unclear. The Odyssey payload includes a comprehensive plasma suite (including measurements of ions and electrons across a continuous energy range from <10 eV to >10 MeV) mounted to provide  $32\pi$ -steradian coverage. Together this suite will provide energy, angular, and mass species distributions of particle populations throughout the magnetosphere to address particle transport processes, identify magnetospheric sources and losses, characterize the radiation belts, and investigate auroral drivers. A radio and plasma waves sensor with three antennas is included to probe waves from a few hertz to 2 MHz, allowing investigation of both magnetospheric wave-particle interactions and auroral radio emissions. The tour's comprehensive coverage of much of the middle and outer magnetosphere as well as the lower-periapsis orbits (<10  $R_N$ ) also allows for sampling of the planet's radiation belts, which largely reside within Triton's orbit (14  $R_N$ ).

It is unknown how Neptune's complex magnetic topology and interactions with the solar wind will influence the structure and location of the planet's auroral emissions. Voyager 2 observed very faint aurora on the dark side of Neptune, but no additional detections of aurora at Neptune have been possible from Earth, in contrast to the irregular auroral bright spot detections at Uranus. It is also unclear what a potential auroral footprint from Triton might look like, given that the moon's orbit is highly inclined relative to the planet's rotational and magnetic axes. Auroral studies are enabled on Odyssey through a combination of remote-sensing and in situ instruments.

### 3. Triton as an Ocean World

The Odyssey mission has been optimized to study both Neptune and Triton because of Triton's extreme importance: Triton is simultaneously a captured Kuiper Belt dwarf planet, twice as massive as Pluto, a suspected ocean world, and an active moon that Voyager showed is of significant geologic, atmospheric, and geophysical complexity. Owing to this unique trifecta that no other world in the outer solar system can claim, its surface, interior, atmosphere, and magnetospheric interaction with Neptune all compel the kind of study that only a Neptune system orbiter can yield.

#### Is Triton an ocean world? (STM-T1)

The complex nature of Neptune's magnetic field and Triton's inclined orbit produce a background field at Triton that oscillates with its synodic period (14.5 h), its orbital period (141 h), and their harmonics. This oscillating field would drive currents in a subsurface ocean and generate an induced magnetic field. By measuring this field on multiple flybys, Odyssey will detect and [characterize the suspected ocean](#)<sup>6</sup>. This technique was used by the Galileo mission to detect [Europa's ocean](#)<sup>7</sup> and will be used by Europa Clipper to characterize that ocean.

#### What causes Triton's plumes? What are Triton's surface geological and compositional features? What sustains its atmosphere? (STM-T1, -T2, -T3, and -T4)

Has Triton differentiated? What is its interior structure? Does it have an intrinsic or crustal magnetic field? Is there an ocean present, and if so, what is its depth and salinity, and how thick is the overlying ice shell? What generates the plumes? What are the geologic processes responsible for Triton's unique landforms? What is the global range of topographic expression on Triton? What is the global range of surface composition, colors, and photometric properties and temperatures across Triton? What is the degree of surficial variability? How are Triton's surface and atmosphere coupled? What is the complete composition of its atmosphere? What are the distribution and composition of hazes and clouds? What is Triton's current and time-variable atmospheric escape rate? What seasonal factors influence Triton's atmosphere, and how are they manifest? How do the plumes affect the atmospheric composition? How has the atmosphere evolved since Voyager's 1989 flyby? What is the ionospheric density, structure, and composition? How are Triton's ionosphere and Neptune's magnetosphere coupled? How does the highly conducting Triton ionosphere interact with the co-rotating magnetosphere of Neptune? How do Triton's ionosphere and magnetic field interact with and couple to the magnetosphere of Neptune? See for example [Hansen et al. white paper](#)<sup>8</sup> for more information.

To address these questions, we defined an orbiter payload with panchromatic and color imagers, composition mapping spectrometers, a laser altimeter, a UV spectrometer, a magnetometer, an ion and neutral gas spectrometer, a thermal imager, radio and plasma wave spectrometers, and a gravity investigation (using the high-gain antenna [HGA]). Further, a tour repeatedly returns to Triton to map its entire sunlit surface, obtain good phase angle coverage, and pass close enough for laser altimetry and in situ ion and mass spectroscopy and gravity studies, and it closely encounters Triton at a wide range of latitudes and local times of day ([Figure 3.5](#)).

We studied a Triton lander element to augment the capabilities of the Neptune Odyssey system orbiter. However, we found a lander to be only marginally useful in addressing the scientific questions above and yet both expensive and risky owing to a lack of knowledge about Triton's surface geotechnical properties.



## **How are Triton’s ionosphere and Neptune’s magnetosphere coupled? (STM-N6, -N7, -T3, and -T4)**

Multiple flybys of Triton provide opportunities to observe and characterize the moon-magnetosphere interaction. Furthermore, matching of Triton’s inclined orbital plane should provide crossings of the planet’s magnetic polar regions, enabling imaging of auroral emissions and in situ sampling of the conjugate magnetic field lines. With the defined tour design and instrumentation, it should be possible to determine whether Triton is responsible for sculpting Neptune’s radiation belts and to directly observe the nature of Triton’s ionospheric coupling to Neptune’s local variable magnetosphere.

## **4. Triton as a Kuiper Belt Dwarf Planet: Comparative Planetology (STM-T4)**

When a population of planets has been studied to some sufficient level of detail, similarities and differences become apparent between them. Comparing and contrasting these attributes is the basis of the discipline of comparative planetology. Because Triton is a captured Kuiper Belt dwarf planet, its attributes can be tested against Pluto and Charon, and as spacecraft visit more dwarf planets, against those worlds as well.

However, owing to the vast population of >100 dwarf planets (diameters > 400 km) in the Kuiper Belt, their extreme distances of several tens of astronomical units, and the very long travel times necessary to reach them, it is unlikely we will see missions to more Kuiper Belt dwarf planets in the foreseeable future. Triton, as a dwarf planet orbiting a giant planet, is thus the most accessible Kuiper Belt dwarf planet to represent and advance comparative planetology of this population. The following paragraph lists related questions Odyssey could address.

How and why are Triton’s geology and geophysics different from Pluto and Charon? How do Triton’s isotopic ratios compare to Neptune and Uranus, Kuiper Belt objects, comets, and other dwarf planets? And how did the capture of Triton impact its bulk composition and interior structure compared to dwarf planets elsewhere in the Kuiper Belt? These questions can be addressed in tandem with those in the [3. Triton as an Ocean World](#) section above, using the listed instruments.

## **5. Small Satellites and Rings**

### **What are the connections between Neptune’s rings, arcs, and small moons? How does the current ring-moon system operate? (STM-S1, -S2, and -S3)**

The most striking component of the complex ring-moon system is a set of ring arcs embedded within the outer Adams ring. The arcs have been observed to change in brightness, drift in position, and, in some cases, completely vanish. The arcs’ stability and confinement are still areas of active research, with solar radiation forces, inelastic particle collisions, co-orbital moonlets, and resonances with other moons all playing potential roles. The current position of the LeVerrier ring is still unexplained, and the sources of the dust-sized particles that dominate the entire ring system have not been identified. Many aspects of Neptune’s dynamical environment, including the potential role of the planet itself, still need to be explored. To address these questions, Odyssey will use a high-resolution visible camera do the following: (1) perform a comprehensive search at all longitudes of rings and arcs and at both low (<60°) and high (>140°) phase angles for small moonlets (>100 m) that could be source bodies for ring material, as well as additional ring and ring structures that could reveal the physical processes operating in this system; (2) take multiple high-resolution looks at the rings in order to identify the role of both outside forces and internal processes, supported by UV and/or NIR stellar occultation’s ring structure measurements; and (3) make precise

measurements of the small moons' positions to quantify their mutual interactions and perturbations from other bodies.

### **What are the origin and evolution of the rings and small moons? (STM-S4 and -S5)**

Neptune's rings and small moons are thought to be remnants of the material present before Triton was captured. Hence, the composition of these bodies can provide information about the solid material that surrounded Neptune when it formed. Unlike the Saturn system, several of the moons are interior to the corotation of the planet, meaning they should move inward until being tidally disrupted. These bodies could therefore have cycled between being moons and rings multiple times. The small moon Hippocamp, discovered in 2004, may be a fragment knocked off of the larger moon Proteus. The history and evolution of the rings and small moons are therefore complex and require further investigation. Odyssey would probe the origins and evolution of the rings and small moons by doing the following: (1) Use a suite of spectrometers from the UV to the NIR at low ( $<70^\circ$ ) phase angles to measure the composition of the material that forms the rings and moons. Odyssey's proximal orbits would enable spatially resolved images ( $<1$  km/pix resolution) on the leading and trailing hemispheres of the known satellites. These reflectance measurements would be compared with Triton to assess how the material initially surrounding Neptune differs from that in the Kuiper Belt. (2) Take advantage of the close moon flybys, taking high-resolution images to map the geological structures on the moons. Radio science measurements of their bulk physical parameters would constrain their bulk composition and geological history. (3) Measure the size distribution of the ring particles through high phase angle ( $>140^\circ$ ) photometry and through UV and/or NIR stellar occultation observations, which are sensitive to ring particles as small as a few micrometers, in order to ascertain their evolutionary timescales. (4) Repeat images of the same ring longitudes and moon positions to search for slow variations in the moons' and rings' orbits due to tidal interactions with the planet that could reveal how the system evolved into its current state. (5) Study distant satellites of Neptune, especially those that orbit retrograde and are likely captured Kuiper Belt objects. Study of these satellites from the UV to NIR can further our understanding of the composition and geology of other small worlds beyond Neptune. Such insight on small Kuiper Belt objects could yield information on early solar system formation and dynamics.

### **Cross-Disciplinary Science Opportunities: Exoplanets and Cruise Phase Science**

Comprehensive characterization of the planet Neptune, with all of these instruments as well as the entry probe, would yield a detailed understanding of the planet itself. The occurrence rate of exoplanets rises sharply as sizes just smaller than Neptune. Having "ground-truth" measurements for Neptune is important for building a comprehensive theory for the origin and evolution of these "[sub-Neptune exoplanets](#)". An observation of particular interest to exoplanets, which may not naturally come out of already planned comprehensive characterization of Neptune, would be UV-to-NIR scattered light from the poles, because that is a particularly likely orientation for a future exoplanet direct-imaging mission.

The imaging suite aboard Odyssey, from UV to thermal IR, provides all the capabilities needed for transformational observations of solar system planets on the cruise phase to Neptune. Disk-averaged unresolved observations are crucial to understanding how our solar system's planets would be viewed "as exoplanets" by a distant observer. In the first 2 years of the mission, look-back observations of Venus and Earth will characterize their scattered light and thermal emission at a variety of phase angles, and, for Earth, monitor rotational variability. In addition, specular reflection "glint" off oceans has been suggested as a hallmark for water on rocky exoplanets. This

glint signature will also be investigated. At later stages of the cruise, observations of a variety of phase angles for Jupiter, Saturn, Uranus, and some of their moons can be used to better understand their scattered light and thermal IR variability. Such observations are important to future exoplanet direct-imaging missions that are in development or under study. The same observations can be done on approach to Neptune, and at apoapse during orbits around the planet.

The comprehensive particle and fields instruments on Odyssey will enable solar wind studies and monitoring of the outer solar system. The particle suite includes an energetic neutral atom (ENA) camera; data from this imaging technique have been used by Cassini and NASA Heliophysics’ Interstellar Boundary Explorer (IBEX) mission to great effect. During cruise and near apoapse during the nominal tour, Odyssey will provide ENA maps of the heliosphere/interstellar medium (ISM) boundary.

The comprehensive remote-sensing suite would also be ideally suited to achieving a New Horizons-like flyby of a Centaur asteroid en route to Neptune. Distant, opportunistic Centaur observations would allow measurement of Centaur light curves and composition maps. We have computed the closest approach distance to all Centaurs along the route (please contact the PMCS team for these and other trajectory details) to make it straightforward for a future science definition team to optimize the trajectory for imaging such an asteroid. Also, it might be possible on the nominal 16-year, no-JGA trajectory to encounter a bonus Jovian trojan asteroid to supplement the Lucy mission.

## 2. High-Level Mission Concept

### Overview

Odyssey would orbit Neptune, using Triton flybys to alter the spacecraft’s orbit around Neptune and applying a similar mission architecture to Cassini-Huygens. Odyssey would collect data and images at a wide range of altitudes and orbital inclinations and would explore other Neptunian moons and rings. This study focused on using annual direct-to-Neptune launch opportunities, development of a trajectory that supports use of both an orbiter and a probe, and an example tour that demonstrates the ability to collect and downlink the observation data to meet the mission goals ([Table 1.1](#)). The study was completed by an integrated team of scientists and engineers from a variety of organizations. The extensive and relevant experience of the organizations involved in Odyssey would be risk mitigating.

**Table 2.1. Mission design table.**

	Value	Units
Orbit parameters (apogee, perigee, inclination, etc.)		
Mission lifetime	240	months
Total flight element #1 (orbiter) mass <b>with</b> contingency (includes instruments)	1594	kg
Total flight element #2 (probe) mass <b>with</b> contingency (includes instruments)	274	kg
Propellant mass <b>without</b> contingency	1910	kg
Propellant contingency	2	%
Propellant mass <b>with</b> contingency	1948	kg
Launch adapter* mass <b>with</b> contingency	106	kg
Total launch mass (maximum expected value [MEV] dry and propellant masses)	3816	kg
Launch vehicle	SLS Block 2	type
Launch vehicle lift capability (including adapter)	4852	kg

	Value	Units
Launch vehicle mass margin (using MEV dry and propellant masses)	1036	kg
Launch vehicle mass margin (%)	21	%

\*The launch vehicle adapter is the structure that goes between the upper stage of the launch vehicle and the launch vehicle/space vehicle separation system. Because the launch vehicle adapter is chosen by the mission (there are a number of options ranging in capability and interface type), its mass is chargeable to the launch vehicle performance.

## Concept Maturity Level and Technology Maturity

The study was conducted at concept maturity level (CML) 4 preferred point design per the definitions provided in [Appendix B](#). The outcome of the study was the evaluation of the trade space and the development of a point design that achieves the mission goals. Where the information needed for CML 5 initial concept implementation was available, the information is included in the trade space, point design, and this study report.

The technology readiness levels (TRLs) of the Neptune Odyssey instruments are shown in [Table 3.1](#) and [Table 3.2](#) for the orbiter and the probe, respectively. This mission can be executed with very little technology development. All components of the orbiter spacecraft and probe are at TRL 6 or higher, except for the Next-Generation Radioisotope Thermoelectric Generator (NGRTG) and the probe thermal protection system (TPS) material (TRL 5) and manufacturing process. These enabling technologies are critical to providing required power and protection to the probe. Process and material improvements may be required if the material thickness required is greater than current manufacturing processes can support. The material thickness needed is determined by the environmental parameters at probe entry and the geometry of the probe itself. The manufacturing process has been proven, but although within the expected capability of the Heatshield for Extreme Entry Environment Technology (HEEET) technology, the peak stagnation pressure and heat flux predicted at Neptune are higher than the levels to which HEEET was previously tested. NASA Ames recommends a delta test program to confidently achieve TRL 6.

The instruments included in the payload for the study all are based on previously flown instruments that may not represent the state of the art but would allow the mission to be flown now without technology development. All of the mission components are at TRL  $\geq 6$ . It is anticipated that there will be technology advances that continue to improve the TRL levels beyond the existing levels.

## Power/Radioisotope Thermoelectric Generator (RTG) Trades

To optimize the power usage, and therefore the number of RTGs needed by the Neptune Odyssey mission, the design utilizes thermo-coupling to the Next-Generation GPHS-RTGs (General Purpose Heat Source – Radioisotope Thermoelectric Generators) using waste heat from the RTGs to reduce the number of heaters and power needed on the spacecraft. Mechanically and thermally, NGRTGs are nearly identical to the GPHS-RTG used for New Horizons, and are described [here](#)<sup>10</sup> as being ready (TRL-8) by 2028, giving this analysis high heritage. Thermal analysis was done, several options for thermal coupling modifications were evaluated, and an approach to doing the thermal coupling with the NGRTG was identified. The summary of the thermal analysis is included in the [Thermal](#) subsection of the [Orbiter Flight System](#) section.

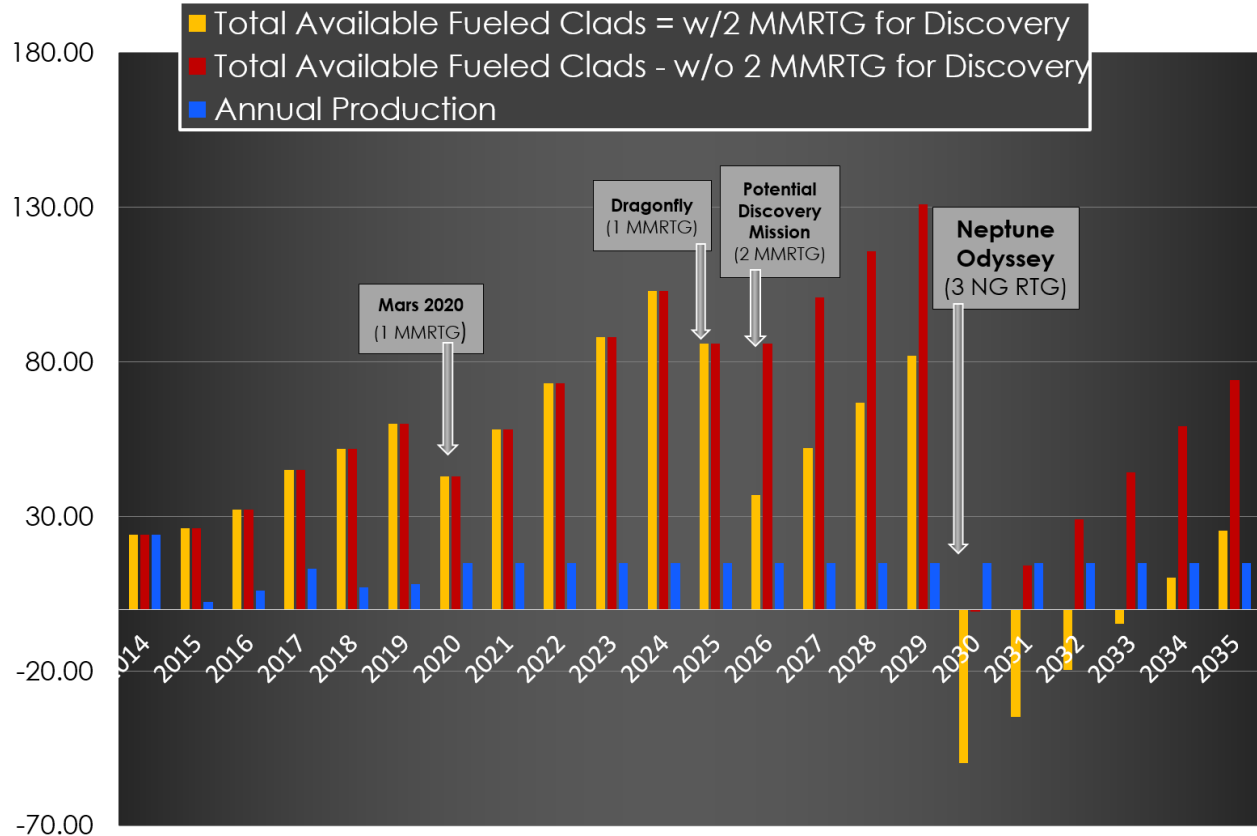

**Figure 2.1. Number of fuel clads available (y-axis) versus year.**

We focused on reducing the power required for this mission concept, for example via the thermal coupling described in the [Thermal](#) subsection of the [Orbiter Flight System](#) section and using a large HGA to reduce power consumption. Neptune Odyssey as currently configured will require three NGRTGs; each NGRTG comprises 16 GPHS-RTG modules, requiring 28.8 kg of plutonium in total, [Figure 2.1](#) is derived from [Zakrajsek et al., 2019](#)<sup>11</sup>.

## Launch Vehicle Trades

Building on and in collaboration with members of the JPL pre-decadal study<sup>34</sup> several trades were conducted to evaluate LVs, launch opportunities, and mass delivered to Neptune. The Neptune Odyssey mission has chosen to use an SLS Block 2 LV with a Centaur kickstage. Choosing this option gives Neptune Odyssey the greatest flexibility in mass, volume, and launch opportunity. The mission design team looked at the launch opportunities with and without a JGA. Requiring a JGA limits launch opportunities to just a few years. The trade determined that using a kickstage or solar electric propulsion (SEP) with a different LV provided the equivalent of the energy gained through the JGA, so SEP could easily be substituted for the kickstage. The launch year (2033) selected for this point design represents (by a small amount) the most mass-constrained option of all annual launch opportunities ([Figure 2.2](#)).

To increase the amount of mass that can be delivered to Neptune, the trajectory selected for the point design takes advantage of a “broken-plane maneuver” (BPM) to reduce needed propellant (the spacecraft performs a burn to exit the ecliptic just after the asteroid belt).



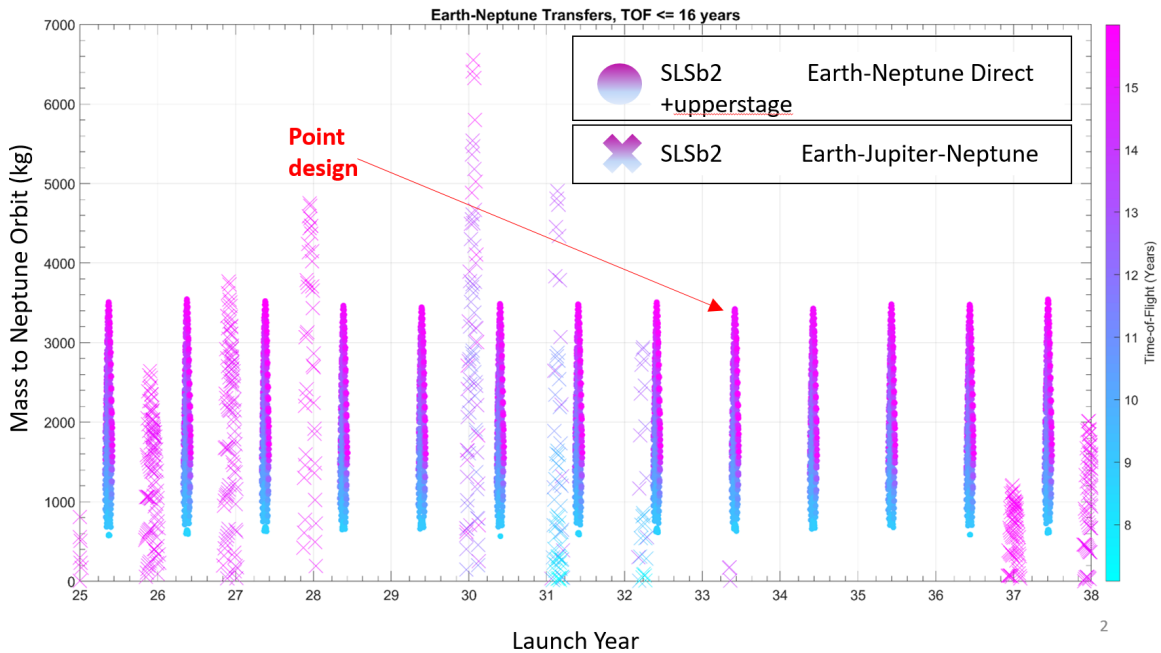

**Figure 2.2. Mass (kg) delivered to Neptune orbit versus launch year. Circles show ~annual direct-to-Neptune launch windows, and crosses indicate launch windows that include a Jupiter gravity assist. Cruise time (years to Neptune orbit insertion) is indicated by the color bar.**

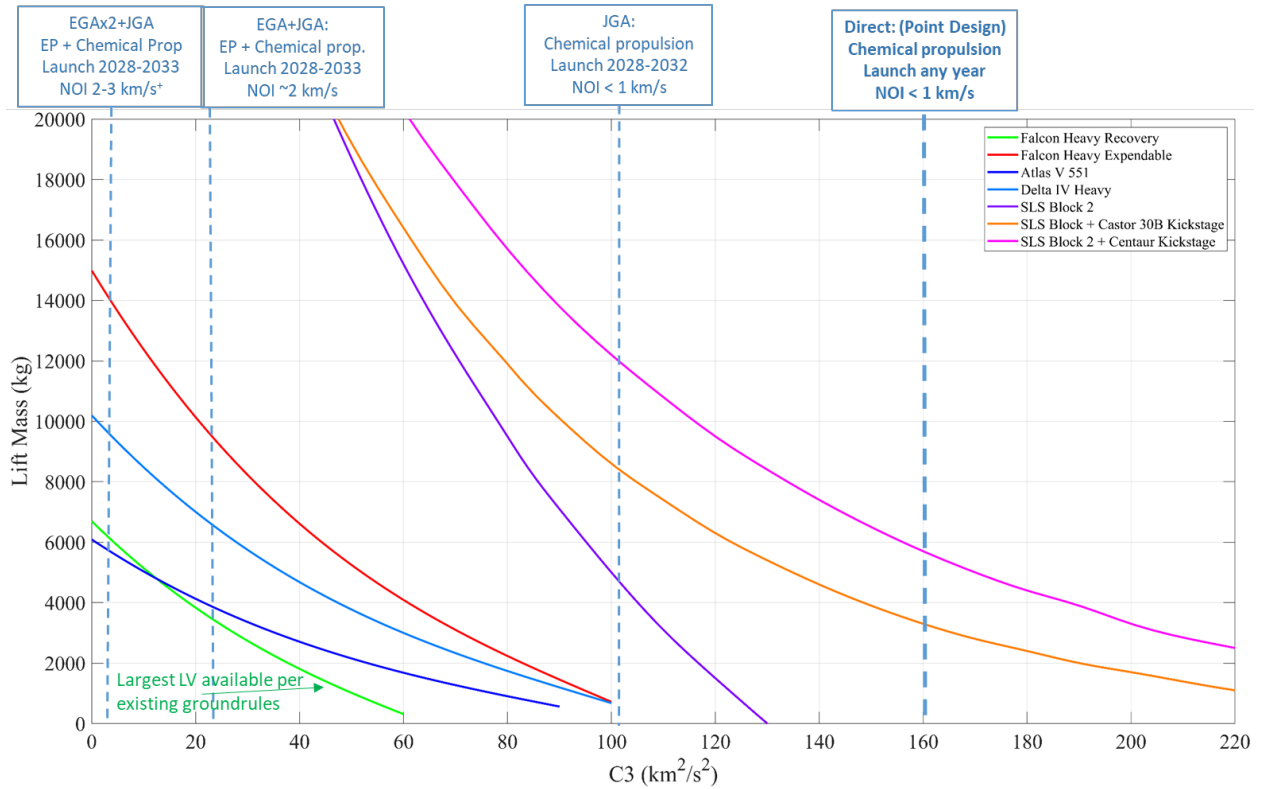

**Figure 2.3. Comparison of launch vehicle performance. Lift mass (kg) versus  $C_3$ ; the defined mission design (without JGA) requires  $C_3 > 160$ .**

[Figure 2.3](#) summarizes the key trades for LVs listed in the index box for cruise phases <16 years. The only LV that is able to deliver the specified mass to Neptune ( $C_3 > 160 \text{ km}^2/\text{s}^2$ ) with a manageable  $\Delta V$  on arrival is the SLS Block 2. **Please note that a Falcon Heavy (FH) expendable with a kickstage or SEP as well as SLS Block 2 with SEP are all viable alternatives.** To use an Atlas V or Delta IV Heavy LV, a JGA or SEP would be required meet the energy ( $C_3$ ) requirements. We would also have to substantially reduce the mass of the spacecraft.

Fairing size was a factor in selecting SLS over FH selection. The Falcon 9/Heavy fairing likely will be too small to house the orbiter and needed SEP/kickstage. It is the shortest of the smaller LV fairings considered. Although fitting the orbiter itself into a Falcon 9/Heavy fairing may be possible, nearly no margin would be left. Unless the SEP stage is very small, Neptune Odyssey will not fit the SEP/orbiter stack within the Falcon fairing, but it is likely that SpaceX could design a new fairing, and if needed, this option should be costed.

## Opportunities for Future Improvements

It is advantageous for power and cost for the spacecraft to be spin stabilized and hibernated for the majority of the cruise phase. The spacecraft as designed must be flown in three-axis stable mode, resulting in increased need for ground operations and Deep Space Network (DSN) time; the need for redundancy to meet lifetime operation requirements may also be increased. We calculated Phase E costs with and without the two hibernative cruise periods. The costs are generated with the NASA-developed, high-level MOCET (Mission Operations Cost Estimating Tool). The cost/month metrics are derived from cost histories for New Frontiers missions, including New Horizons, and outer-planet Flagship missions such as Cassini. The resulting costs cover mission operations and science but not DSN charges. Savings from adding the hibernative cruise phases is \$160M in FY25 dollars.

With the current spacecraft, probe, and tour designs, the geometry for the communication links to return data from the probe is complex and constrained. The probe entry and orbiter insertion at Neptune are closely spaced. The orbiter will need to do maneuvers in preparation for the insertion. Those maneuvers alter the antenna pointing, breaking the communications with the probe. As currently defined, data to 10 bar can be received and the minimum required measurements are returned, but further study could further optimize the window and maximize data return from the probe.

Gap analysis between the heritage instruments and payload revealed the following potential improvements: Color Narrow Angle Camera: New Horizons LORRI augmented with a color filter wheel (already designed for APL's MANTIS mission concept). Vis-IR Imaging Spectrometer: New Horizons' Ralph augmented with IR sensitivity out to 5- $\mu\text{m}$  wavelength. EPO Camera: Rosetta/Philae CIVA cameras augmented with a red-green-blue Bayer filter to allow true-color images.

The defined payload has a spectral gap at 0.18-0.4 micron region, this is a spectrally rich region with potential surface composition clues for Neptune's moons<sup>32</sup>. To avoid this spectral gap, and address lessons learned from the Cassini mission, a final mission might aim to fly new (high TRL) technology UV detectors such as delta-doped electron-multiplying charge-coupled device (EMCCD) (e.g., Nikzad et al. 2000<sup>33</sup>).

## Preserving Knowledge and Cultural Continuity

Space exploration is a team effort, and missions require a plan for managing interactions over a multi-decade span. The literature on the science of team science provide a series of best practices and insights into the human element of scientific collaborations. A Neptune mission would additionally draw upon lessons learned from past missions, especially Cassini, to identify ways to meet three significant challenges on the human scale for a future mission to Neptune; these aspects of the study also apply to other missions and will be shared accordingly.

**Data Stewardship.** Prior studies of long-term projects demonstrate significant hurdles in data management, including establishing standards, maintaining compatibility, and instrumental health<sup>12,13</sup>. A mission to the outer solar system should propose techniques to:

- **Produce robust, long-term plans** for data stewardship, with clear expectations shared across the instrumentation suite<sup>14</sup>
- **Share data** in ways consistent with the operational considerations of the mission<sup>15</sup>
- **Produce a local database that feeds the archive pipeline** with quick-view products available for establishing cross instrumental partnerships
- **Fund stewardship**, compatibility, and process responsibilities, making data work a valued part of the investigation<sup>16</sup>

**Planning for the Long Term.** From point of mission formulation through development and cruise, it will take well over a decade for this mission to reach its target, let alone begin investigations. A mission to the outer solar system should propose techniques to:

- **Adopt a bureaucratic-hierarchical form**<sup>17</sup>, consistent with the Flagship organizational style which best permits multi-generational leadership and team participation and turnover. Such social forms are more likely to support women and minorities in advancement<sup>18,19</sup> and to support the encyclopedic data collection expected of Flagship missions<sup>20</sup>.
- **Include a plan for multi-generational leadership.** For example, each instrument team could nurture more than one deputy-PI to develop to share the experience and skill set necessary for leadership<sup>21</sup>.

**International Partnership.** A mission of this scale and scope would benefit tremendously from international partners, both in terms of scientific expertise and fiscal support. For Neptune, advanced discussions exist, e.g., *Workshop on In Situ Exploration of the Ice Giants*, Marseille, France, January 2019, and a just-completed ESA-led study (<http://sci.esa.int/future-missions-department/61307-cdf-study-report-ice-giants/>) found that an ESA-provided entry probe is the most technologically mature and least expensive option for ESA participation in a NASA-led ice giant mission. International partnerships can be difficult to sustain because of the pressures of institutional and national requirements as well as cultural differences<sup>22</sup>. Study of the extraordinarily successful Cassini mission demonstrates this is best managed through relational work at the level of the mission scientists and technical teams<sup>23</sup>.

### 3. Technical Overview

The flight system consists of a single Neptune Odyssey orbiter with accommodated Neptune atmospheric probe. The spacecraft enters the Neptune-Triton system after a long cruise, plane-change maneuver, probe deployment, and Neptune orbit insertion (NOI) burns. See the [Concept of Operations and Mission Design](#) section and Appendix B for timeline and trajectory. The orbiter has been designed to host all 14 instruments. The spacecraft has sufficient power, thermal, volume, and mass to meet the science objectives. The probe has sufficient battery, thermal, and data volume to host the eight instruments and meet the atmospheric science objectives.

#### Orbiter Instrument Payload Description

The instruments and spacecraft components were chosen for their heritage to minimize the risk to the mission. The payload was selected to achieve the science objectives that flowed from the mission goals and is based on previously flown instruments that do not necessarily represent the state of the art but would allow the mission to be flown now without technology development. [Table 3.1](#) provides a summary of the mass, power, and cost for each instrument on the orbiter. Any instrument that has flown is assigned TRL >6. Detailed tables for each instrument are provided in the Details for Each Orbiter Instrument section in Appendix B.

**Table 3.1. Neptune Odyssey orbiter instrument payload (includes mission/instrument heritage, TRL, mass, power, and cost). Small discrepancies from Table B.4 are due to contingency margin.**

	Measurement Range	Heritage Mission/ Instrument	TRL	Mass with Contingency (kg)	Power with Contingency (W)	Cost in FY25 \$M (+15% cf. FY20)
Magnetometer	<b>Range</b>	MESSENGER/Mag	>6	4.70 (including boom)	5.80	7.1
	±1530 to ±51,300 nT					
	<b>Resolution</b>					
	0.047–1.6 nT					
Color Narrow-Angle Camera	350–850 nm, ~20 channels	Lucy/L'ORRI & New Horizons/LORRI	6*	9.90	5.75	17.5*
UV Imaging Spectrograph	465–1881 Å	New Horizons/Alice	>6	5.00	5.75	15.1
Ion and Neutral Mass Spectrometer	1–99 Da	Cassini/INMS	>6	10.60	26.80	43.2
	100–1,000,000 channels					
Laser Altimeter	1064.5 nm	MESSENGER/MLA	>6	8.50	28.75	21.8
Vis-NIR Imaging Spectrometer	0.4–0.975 µm, 6 channels	Lucy/L' Ralph & New Horizons/Ralph	6*	35.65	27.60	60.6
	1.0–5.0 µm, 1472 channels					
Radio and Plasma Wave Detector	18 channels/decade	Juno/Waves	>6	14.60	9.32	10.3
	<b>Electric</b>					
	few Hz – 20 MHz					
	<b>Magnetic</b>					
	few Hz – 20 kHz					
Thermal Infrared Imager	0.35–400 µm, 9 channels	LRO/Diviner	>6	11.50	18.40	29.3
Microwave Radiometer	0.6–22 GHz, 6 channels	Juno/MWR	6	52.90	36.80	56.4
Thermal Plasma Spectrometer	<b>Ions</b>	Juno/JADE	>6	14.71	3.35	35.8
	0.01–46.2 keV					
	1–50 amu					
	<b>Energy Res.</b>					
	28–18%					

	Measurement Range	Heritage Mission/ Instrument	TRL	Mass with Contingency (kg)	Power with Contingency (W)	Cost in FY25 \$M (+15% cf. FY20)
	<b>Mass Res.</b>					
	2.5–11					
	<b>Electrons</b>					
	0.1–95 keV Energy Res: 10.4–13.2%					
Energetic Charged Particle Detector	<b>Ions</b>	Parker Solar Probe/EPI-Lo	>6	3.91	4.31	15.5
	20 keV – 15 MeV					
	<b>Electrons</b> 25–1000 keV					
Energetic Neutral Atom Imager	<b>Neutrals</b>	IMAP/Ultra	6*	8.20*	7.60*	25.8*
	3–300 keV					
	<b>Ions</b> 5 MeV					
	<b>Electrons</b> 30–700 keV					
Dust Detector	1–500 amu	IMAP/IDEX	6*	13.28*	15.27*	15.1*
	≥200 m/Δm					
EPO Camera	400–900 nm, 3 channels	Rosetta/CIVA	>6	0.80	2.30	1.9

\*CBE = Current Best Estimate.

## Probe Instrument Payload Description

[Table 3.2](#) provides a summary of the mass, power, and cost for each instrument on the probe.

**Table 3.2. Neptune Odyssey probe instrument payload (includes mission/instrument heritage, TRL, mass, power, and cost).**

	Heritage Mission/Instrument	TRL	Mass with Contingency (kg)	Power with Contingency (W)	Cost in FY25 \$M (+15% cf. FY20)
Mass Spectrometer	Galileo Probe/MS; Cassini-Huygens	9	16.90	28.75	22.4
Atmospheric Structure Instrument	SNAP Study/ASI; Cassini-Huygens/HASI	6	1.82	5.75	5.6
Helium Abundance Detector	Galileo Probe/HAD	9	1.82	1.00	3.5
Ortho-Para H <sub>2</sub> Detector	Ice Giant SDT	6	0.65	4.00	4.4
Nephelometer	Galileo Probe/Nephelometer	9	2.99	5.29	7.1
Net Flux Radiometer	Galileo Probe/Net Flux Radiometer	9	4.07	4.60	8.2
Doppler Wind Experiment	Huygens Probe/DWE	9	0.43	1.40	
Public Engagement Camera	Rosetta/Philae	9	0.78	2.30	2.8

NB. The Doppler Wind Experiment is part of the radio frequency (RF) system and counted in the Master Equipment List (MEL) and Power Equipment List (PEL) of the probe and not probe instrument payload.

## Science Data Rates and Volume

We estimated the representative data volume needed to satisfy the STM assuming (1) no data compression, (2) low-end data compression (compression factors of 2–5), and (3) high-end data compression (compression factors of 10–20). Early in the study, we used a low-fidelity iteration of the orbital tour, which assumed a representative 20-orbit, 840-h/orbit mission. (Because of the time-intensive computer processing for the orbital tour, this was finished very late in the study.)

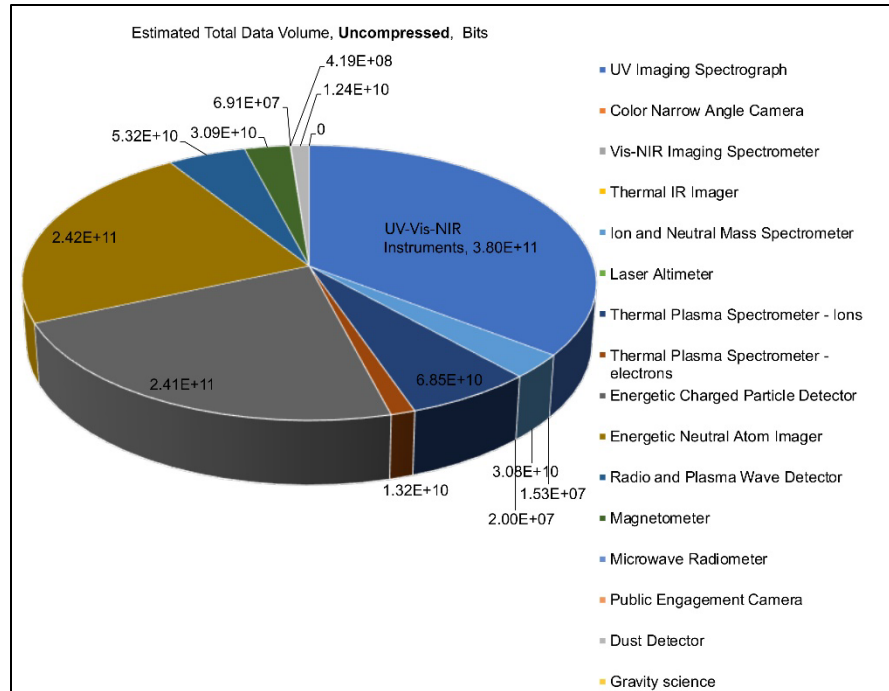

**Figure 3.1. Data volume breakdown per instrument.**

(Because of the time-intensive computer processing for the orbital tour, this was finished very late in the study.)

Although the higher-fidelity, calculated orbital tour has, on average, a shorter orbital period and thus less time to transmit data—but more than 20 orbits—we believe the following estimation is accurate to within a factor of ~1.5. Data volumes are given in bits for the full, 20-orbit representative mission. The full table, with rationale for each estimation, is given in [Table B.29](#). We assumed data rates and volumes from specific heritage instruments and similar phases of past missions. The total data generated for 20 representative orbits (uncompressed, low-end compression, high-end compression, respectively) are  $1.07 \times 10^{12}$ ,  $6.01 \times 10^{11}$ , and  $4.28 \times 10^{11}$  bits.

## Orbiter Flight System

The orbiter uses its large, dual-mode propulsion system engines (445 N HiPAT) for plane-change and NOI  $\Delta$ -V maneuvers, and later for orbit-adjustment  $\Delta$ -V maneuvers. It uses its smaller 4.4-N (1-lbf) reaction engine assemblies as attitude control subsystem (ACS) actuators, along with its reaction wheel assemblies (RWAs). The flight system would employ three-axis stabilization and feature the following: a body-fixed Earth-pointing HGA and a payload suite that is partially body fixed, with selected imaging instruments (narrow-angle camera, IR spectrometer, UV spectrometer, IR camera) articulated such that their field of view (FOV) is adjusted cross-track; X- and Ka-band science data downlinks; and three NGRTGs to provide power.

The flight system would be dual string with cold spares and a 4-m-diameter HGA. The equipment layout and thermal design are intended to minimize heater power required. All of the bus equipment and much of the payload share a highly insulated single enclosure. [Figure 3.2](#) shows the orbiter and probe layout and payload configuration, [Figure B.2](#) shows the overall spacecraft dimension, and [Figure B.3](#) shows the flight system block diagram.



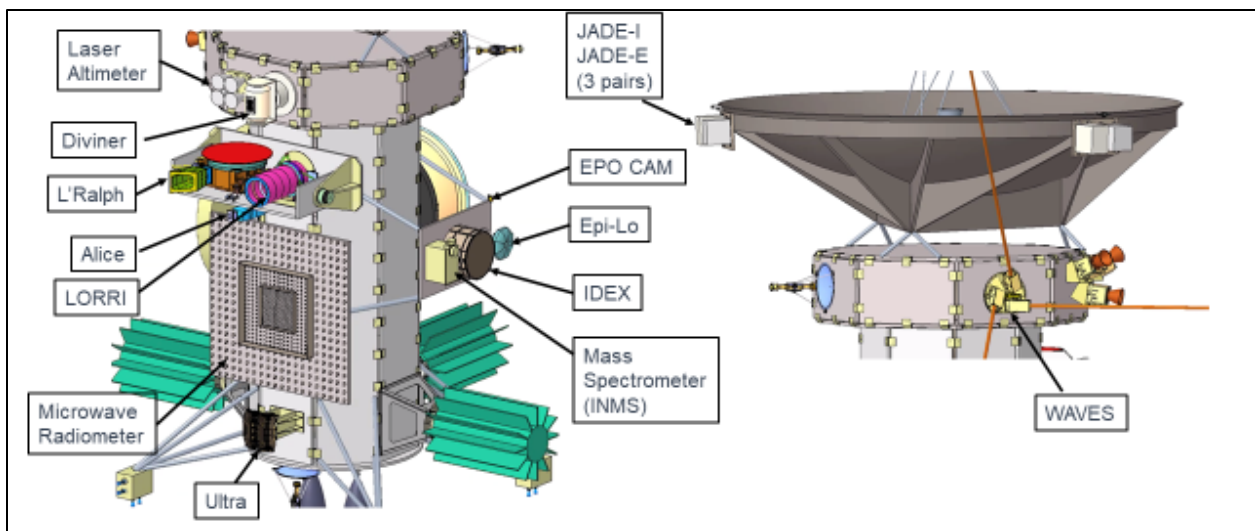
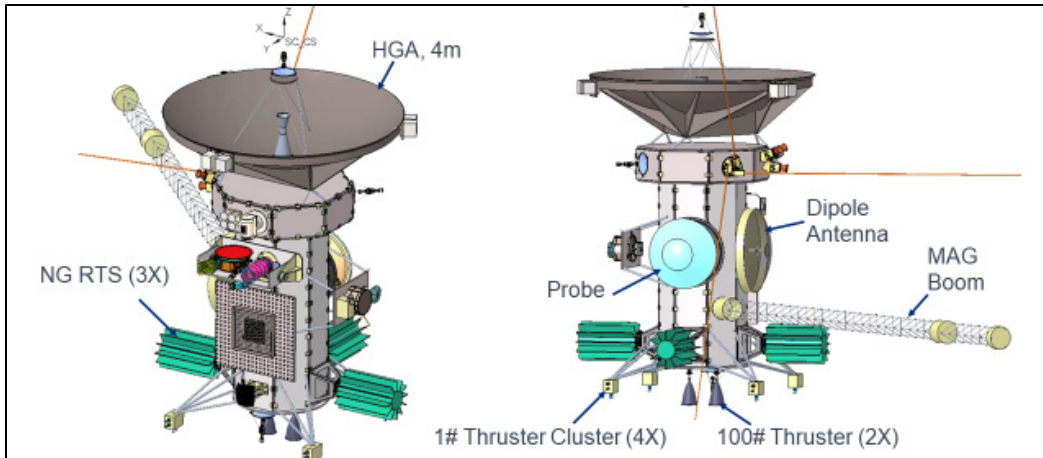

**Figure 3.2. Orbiter and instrument configuration.**

**Table 3.3. Neptune Odyssey system mass summary.**

SLS Block 2B/Centaur Capability* at 154 m <sup>2</sup> /s <sup>2</sup>	4958
Payload Adapter/Sep. System MPV Mass, MEV	106
SLS Block 2B – Centaur Capability, including adapter	4852
Total Propellant Mass, MEV	1948
Flight System Dry Mass, MPV	2904
MEV Launch Mass	3816
Flight System Dry Mass, MEV	1868
Total Propellant Mass, MEV	1948

**Table 3.4. Neptune Odyssey flight system dry mass summary.**

Subsystem	CBE	Cont.	MEV
Command and Data Handling (C&DH) (Avionics)	12	15%	14
Guidance, Navigation, and Control (GNC)	64	15%	74
Electrical Power System (EPS)	242	15%	278
Harness	104	15%	120
Thermal	96	15%	110

Subsystem	CBE	Cont.	MEV
RF Communications	88	15%	101
Propulsion	197	15%	227
Mechanical	347	15%	399
<b>Spacecraft Bus Total</b>	<b>1149</b>	<b>15%</b>	<b>1321</b>
<b>Payload</b>	<b>250</b>	<b>16%</b>	<b>290</b>
<b>Neptune Probe</b>	<b>210</b>	<b>30%</b>	<b>274</b>
<b>Flight System Dry Mass</b>	<b>1610</b>	<b>17%</b>	<b>1886</b>
<b>Dry Mass MPV</b>			<b>2904</b>
<b>Dry Mass Total Margin (kg, %)</b>	<b>1294</b>		<b>45%</b>

**Table 3.5. Summary of fuel requirements as a function of mission stage.**

Event	Predicted $\Delta$ -V, m/s	Propellant, kg	
Launch cleanup	30	36.5	
Neptune targeting	20	24.2	
Broken-plane burn, probe release and deflect	487	544	
Capture/pump down	1067	858.2	
Petal rotation 1	20	20.4	
Mapping 1	25	25.3	
Transition 1	5	5	
Mapping 2	25	24.9	
Petal rotation 2	20	19.7	
Mapping 3	25	24.4	
Transition 2	5	4.8	
Mapping 4	25	24.1	
Disposal	121	74.9	
ACS	56	50.9	
<b>Margin (m/s, kg, %)</b>	<b>337</b>	<b>172.5</b>	<b>15%</b>
<b>Total</b>	<b>2268</b>	<b>1948</b>	

The spacecraft team evaluated a number of power modes that were potential hot- or cold-case thermal drivers or total load power drivers. For the remainder of the power bus, we applied a 43% contingency based on the design requirements with conversion efficiency, switching, and distribution losses applied to determine available power. A power mode summary is provided in [Table B.31](#) of Appendix B. Total propellant mass is CBE + contingency = 1948 kg.

## Guidance, Navigation, and Control (GNC)

The Neptune Odyssey GNC provides a three-axis-controlled platform that satisfies all requirements set by science, navigation, communication, and propulsion. All GNC components are available commercial off-the-shelf (COTS) with multiple potential vendors.

During Neptune orbital operations, the GNC will keep the bus nominally nadir-pointed toward the target body (either Neptune or one of its moons) and control off-pointing via the instrument platform gimbal. The body-fixed HGA will be pointed at Earth for science downlink. Because of the overall spacecraft size, the spacecraft agility using the reaction wheels will be very limited, so large slews will be accomplished via firing of the thrusters. The reaction wheels will be used for fine pointing control and to minimize jitter for the most sensitive measurements. Additional detail on the GNC subsystem is provided in the appendices.



## Spacecraft RF Communications Subsystem (Orbiter)

The telecommunications system features a fully redundant design, including two radios, all necessary redundant RF cabling and switching, and two ultra-stable oscillators (USOs). The radios are connected to a suite of antennas that includes three low-gain antennas (LGAs), three medium-gain antennas (MGAs), and one HGA. The HGA is a 4-m dish similar in design to the Europa Clipper HGA. One of the three LGAs is dedicated to the ultrahigh frequency (UHF) probe link; this link is responsible for receiving probe telemetry during its descent into the atmosphere. Both USOs are operated in an active cross-strapped configuration and will be powered on and available throughout the mission to provide a precision clock source for both radio science and communications. The Ka-band transmission will be supported by an 80-W amplifier, and the X-band will be supported by a 12.5-W amplifier. The spacecraft will communicate to the DSN's family of 34-m beam waveguide antennas. At Neptune, the Ka-band downlink will provide a 29-kbps link with the DSN. This will allow for ~100 Mbit/h (800 Mbit per 8-h window) of science data being sent to Earth.

## Propulsion

The baselined propulsion system for the spacecraft is a dual-mode, pressure-regulated system that provides  $\Delta$ -V capability and attitude control for the spacecraft. The system consists of two main bipropellant ( $N_2H_4$ /NTO) apogee engines in the 445–645 Newton class (100–150 lbf), 16 4.4-N (1.0-lbf) monopropellant ( $N_2H_4$ ) ACS thrusters, and components required to control the flow of propellants and monitor system health and performance. The propulsion system will be purchased as a complete system from a proven supplier who will integrate it onto a Johns Hopkins Applied Physics Laboratory (APL)-furnished spacecraft structure.

The hydrazine is stored in a single 1252-liter titanium tank. The oxidizer is stored in a separate 604-liter titanium tank. Both tanks require custom propellant management devices (PMDs) to ensure positioning of gas-free propellant for all maneuvers at the tank outlets. The maximum expected operating pressure (MEOP) for the mission is 250 psi. Helium pressurant will be stored at a MEOP of 4500 psi in a custom composite-overwrapped titanium pressure vessel. A set of pressure regulators are used to ensure appropriate pressures in the propellant tanks and downstream lines. In addition, the design uses separate routings of check valves, latch valves, and series-redundant pressure regulators to limit fuel and oxidizer migration to the shared pressurant tank. A similar isolation design was used by MESSENGER. Additional detail on the propulsion subsystem in [Table B.29](#) and associated text.

## Orbiter and Probe Avionics

The Neptune orbiter avionics architecture is designed for block redundancy with interface cross-strapping. The avionics hardware is separated into three primary housings: the integrated electronics module (IEM), the remote interface units (RIUs), and the propulsion diode boxes (PDBs). This approach is consistent with previous APL spacecraft programs. It will take advantage of extensive use of heritage hardware from Parker Solar Probe and Europa Clipper.

Command and data handling (C&DH), guidance and control (G&C), and spacecraft fault protection functions will be performed in a single radiation-hardened, quad-core, GR740 processor. A cold redundant processor and solid-state recorder (SSR) will serve as backup. The redundant pro-

cessor can be placed in a warm-spare state as needed. The avionics mode controller will continually monitor the status and health of the single-board computer (SBC) and SSR systems and switch or change power states of the equipment if necessary.

The SSR will form 16 8-Gbit memory banks by stacking four 2-Gbit flash memories. This design leverages existing technologies developed for the Parker Solar Probe mission. Tests will be conducted to verify proper operation of the 2-Gbit memories at a total dose limit of 100 krad, while operating at a 10% duty cycle.

The Neptune probe avionics architecture is designed for block redundancy. The avionics hardware consists of SBCs and mission-specific cards (MiSC). This will take advantage of extensive use of heritage hardware from Parker Solar Probe and DART. C&DH, G&C, and spacecraft fault protection functions will be performed in a single radiation-hardened, quad-core, GR740 processor, same as the orbiter.

The MiSC will provide probe components and instrument interfaces as well as monitoring of temperature sensors. Because the probe will separate from the orbiter 30 days before entering Neptune atmosphere, a low-power and highly optimized timer circuit for power sequence is needed. This timer will work from a 5-V battery, consume no more than 250 mW, and be incorporated as part of the MiSC card design.

## Power

### Orbiter Electrical Power Subsystem (EPS)

The EPS provides power generation, regulation, and distribution for the vehicle through all mission phases. The subsystem is designed to provide a minimum of 30% margin in all load cases. See [Table B.32](#) for additional information.

**Power Generation.** Three NGRTGs provide power to the vehicle. Together the NGRTGs provide 1600 W when initially loaded with fuel and are estimated to provide 1011 W at the end of the mission, assuming the RTGs are loaded 2 years before launch. The RTGs are provided by NASA and will be installed at the launch base. Spacecraft testing will be achieved using RTG simulators, which are similar in form, fit, and function to the RTGs, but the thermocouples are heated using electrical heaters rather than plutonium.

**Power Regulation.** RTG output power is regulated by a linear sequential shunt system with design heritage from the Van Allen Probes and New Horizons missions. The shunt regulator provides power bus voltage control using a fault-tolerant three-stage majority voted control loop to ensure control is maintained under all conditions. The shunt regulator implements a linear sequential topology that can operate with the failure of any single stage, and includes redundant communications interfaces to the spacecraft avionics.

Excess RTG power is dissipated in two sets of shunt resistors. These are located “internal” and “external” to the thermos bottle design described in the [Thermal](#) section of this report. The external shunts are sized to dissipate the difference between beginning of mission (BOM) and end of mission (EOM) RTG power. This allows the dissipation internal to the thermos bottle to remain nearly constant throughout the mission.

**Power Distribution.** Power distribution is provided by block redundant power-switching units (PSUs) similar in concept and topology to many previous missions, including Van Allen Probes,

Europa Clipper, Parker Solar Probe, etc. The switching services are divided into safety and non-safety services; multiple inhibits prevent the former from inadvertent activation. The safety services can also be de-energized when not in use to conserve power. Because the PSUs are block redundant, only a single command and telemetry interface is included. If necessary, a redundant interface can be added so that each PSU can communicate with the redundant avionics.

### **Probe Electrical Power System**

The EPS provides power distribution and energy storage for the probe. Block redundant power distribution is implemented using the same switch slices used in the PSU described above. For the probe, these cards are not separate units but instead are included in consolidated probe electronics modules. Two lithium thionyl chloride primary batteries, selected for high energy density and long storage life, provide power to the probe. The first provides power only to a timer circuit activated when the probe is separated from the orbiter. The second provides power to the probe during descent operations. Before deployment, the probe electronics can be checked by supplying power from the orbiter. The primary batteries remain isolated during these periods.

Thermal batteries, secondary lithium-ion batteries, and other lithium primary chemistries with flight history were considered as part of this study. Thermal batteries have been qualified for 30 years of storage life but are designed for hours, rather than days, of operation after activation. Secondary cells provide lower energy density than primary cells and would require charge and balance electronics for maintenance through the long cruise. Therefore, lithium primary cells with flight heritage for longer performance were selected.

## **Mechanical**

The orbiter is configured with a propulsion module that encloses three stacked propulsion tanks, and a vault module that accommodates electronics. Both the propulsion module and the vault module are honeycomb sandwich panels assembled in octagon geometry that provide flat mounting interfaces for instruments and external components. The 4-m-diameter HGA is located on top of the vault. This top-mount HGA arrangement and the stacked propulsion tanks configuration are driven by the desire to fit into a 5-m fairing, which is common for several available LVs. The orbiter +Y direction is defined as the nadir direction, and the -X direction is defined as the ram direction. The 2.6-m-diameter Neptune probe is mounted to the opposite nadir side (-Y side) of the orbiter with a push-off separation interface that enables the probe to spin up while separating from the orbiter. A dipole antenna is used for communicating with the probe after its separation from the orbiter.

There are 14 instruments onboard the orbiter, with seven facing the Nadir direction. A single-axis gimbal-driven platform provides the imaging instruments with  $\pm 30^\circ$  range of motion. A biaxial gimbal assembly gives the IR radiometer a  $\pm 30^\circ$  range of motion around the Z-axis and a  $\pm 90^\circ$  range of motion around the Y-axis. Two fluxgate magnetometers are accommodated by a 10.5-m-long coilable-style deployable boom.

The orbiter is powered by three NGRTGs that are mounted near the lower section of the orbiter at  $90^\circ$  apart. Sixteen 1-lb thrusters, arranged in four clusters extended from the orbiter via composite struts, are located  $45^\circ$  from each of the three NGRTGs.

## Thermal

The Neptune Odyssey orbiter thermal design accommodates the range of mission solar distances, providing temperature control of the instruments and probe during the launch, cruise, and science mission phases. The instruments, HGA, and probe are thermally isolated from the vault and propulsion modules.

The vault module uses the same compensation heater approach as New Horizons. Electronic components are thermally coupled to the vault structure. The heat dissipation within the module is held nearly constant by powering heaters to make up as electronics boxes are turned off. Louvers provide passive control of the vault module temperatures during variations in solar distance, external optical property degradation, and internal dissipation. The remaining vault module external surfaces are isolated from these changes using multilayer insulation (MLI) blanketing.

The NGRTGs are accommodated by maintaining a large view to space for waste heat rejection via the finned radiators and supported from the propulsion module. A portion of the waste heat generated by the NGRTGs is used to heat the propulsion module by tailoring the thermal conductivity of the mounting brackets. Once the heat has moved to the bracket baseplate, it is transported around the propulsion module via vertical and lateral constant conductance heat pipes (CCHPs). The propulsion tanks as well as the propulsion module panels are covered in MLI to create a “thermos bottle” that maintains the propulsion tanks’ temperature and reduces thermal gradients.

## Probe Flight System<sup>24–30</sup>

The Neptune Odyssey probe has a mass of 273.2 kg, including 30% contingency. More than half the mass is dedicated to the TPS/entry and descent systems. Within the TPS aeroshell, the descent module houses and manages all science instruments and electronics, except for Engineering Science Investigation (ESI) instrumentation sensors that are used to inform Engineering, Descent, and Landing (EDL) models and are embedded within the TPS itself. The orbiter separation mechanism provides spin stabilization of the probe during the approach and entry into the Neptune atmosphere.

The descent module itself is a truncated sphere for atmospheric stability and provides sufficient clearance margin to the interior of the TPS and the mortar-fired descent parachute attached to the backshell. Provisions for anti-spin vanes are included as the design matures. Both the descent module and heat shield have a load path through the backshell. Two sets of three separation mechanisms provide for separation of the heat shield from the backshell, and for the descent module from the backshell. Interior temperature of the descent module is maintained during the 30-day approach using radioisotope heater units (RHUs) to alleviate battery capacity that would otherwise be needed for thermal control. Thermal switches to a radiator on the descent module shell provide for thermal management during cruise, approach, and descent.

During cruise to the Neptune system, the probe flight computer and individual components may be checked and updated using bus power provided by the orbiter; however, the majority of probe electronics are unpowered during cruise and Neptune approach except as needed for opportunistic cruise science. A redundant low-power timer circuit, triggered by orbiter separation, is powered during the 30-day final approach and governs the sequencing of bus power-up based on the expected time of atmospheric entry. Instruments requiring warm-up are powered before entry, such as the USO supporting Doppler wind measurements. Instruments requiring calibration measurements before exposure to the atmosphere are powered before heat shield separation. Accelerometer

and ESI data are recorded during the entry and high-g-load deceleration of the probe. Once the descent module separates from the aeroshell, the instruments begin recording science data to be relayed to the orbiter for eventual return to Earth after NOI.

For more information, see Appendix B, RF Communications section.

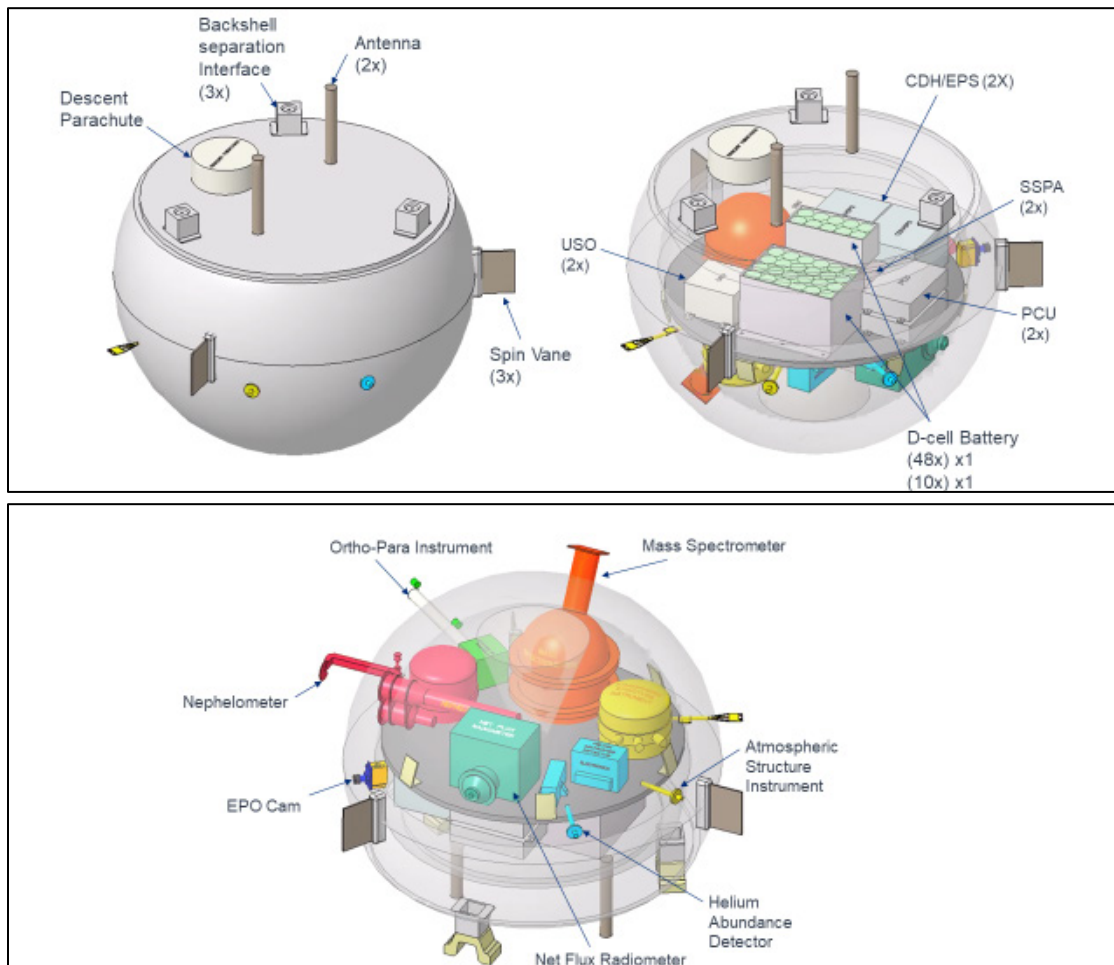

**Figure 3.3. Descent module.**

## Thermal Protection System

A variety of entry trajectory designs were evaluated for initial aerothermal environment and HEEET TPS sizing, resulting in selection of a  $-17.8^\circ$  entry flight path angle as the best option for the probe. Steeper entries yielded stagnation pressures that were beyond the capability of ground test facilities, and shallower entries with higher heat loads resulted in HEEET thicknesses that were greater than current manufacturing abilities. Entry trajectory analysis was conducted using NASA Langley's POST2 software, and aerothermal environments were obtained via computational fluid dynamics (CFD) simulations using data parallel line relaxation (DPLR). A summary of entry parameters, environments along with detailed description of the material and testing is provided in [Table B.35](#) and associated text.

# Concept of Operations and Mission Design

## Interplanetary Trajectory

The interplanetary trajectory delivers *Odyssey* from Earth parking orbit to a hyperbolic encounter with Neptune. In balancing competing goals that include time of flight, LV availability for the required  $C_3$ , phasing of gravity assist bodies, and arrival  $v_\infty$  at Neptune, three alternatives were evaluated: chemical/direct, chemical/direct with a JGA, and chemical with a SEP stage.

Each alternative provides interplanetary trajectories capable of delivering the payload within a 17-year time of flight. However, the last two alternatives were not selected as the baseline. First, although SEP is feasible, it was not selected as the baseline to retire the risk of carrying two separate propulsion subsystems (chemical and SEP). In addition, SEP trajectories lead to higher arrival  $v_\infty$  at Neptune that results in higher  $\Delta$ -V necessary to capture into Neptune's orbit. Second, although chemical trajectories that rely on a JGA can significantly increase delivered mass, these were not selected as the baseline because the required Earth/Jupiter phasing is not favorable between mid-2033 and late 2036, thus leading to a 3-year gap in launch opportunities.

Instead, a purely chemical, direct-to-Neptune trajectory was selected. Launch opportunities that satisfy mass and time-of-flight requirements are available every year in the 2030–2040 decade, each with a period of 18 consecutive daily launch windows arriving to Neptune with  $v_\infty$  of  $\sim 6.5$  km/s. All opportunities can deliver a mass of  $\geq 3400$  kg after Neptune injection.

The 2033 launch opportunity was selected as baseline because it delivers the worst mass performance across the decade. As such, feasibility for this opportunity demonstrates feasibility for the rest.

To increase performance, the  $\Delta$ -V required for interplanetary transfer is broken into two maneuvers: First is the trans-Neptunian injection (TNI), an 8.6 km/s maneuver executed on May 31, 2033, while in a 2000-km Earth parking orbit, that injects the flight system into a highly eccentric ( $e = 0.97$ ) heliocentric orbit departing Earth with  $C_3$  of  $148.3 \text{ km}^2/\text{s}^2$ . The LV upper stage will be used for the TNI. Second is the BPM, a 245 m/s maneuver executed on November 12, 2036, that changes the orbital inclination of the interplanetary trajectory by  $0.5^\circ$  and aligns the transfer plane to intersect Neptune. After an interplanetary trajectory lasting 15.9 years, *Odyssey* starts its approach to Neptune on May 4, 2049, injecting into elliptical orbit on June 3, 2049.



The purpose of the BPM is to distribute the need to increase orbital energy and change orbital plane between two maneuvers, and its performance advantages are not specific to the 2033 opportunity. Selecting a direct-to-Neptune trajectory for the baseline design does not preclude the overall concept from relying on a JGA should the flight system be launched by 2031 or earlier.

### Launch Vehicle Options

The direct-to-Neptune interplanetary trajectory requires a launch  $C_3$  of up to  $160 \text{ km}^2/\text{s}^2$  to deliver the required mass within the time-of-flight limit. This launch performance is well within the capabilities of the SLS equipped with Block 2 boosters and a Centaur upper stage (which can be removed if the interplanetary trajectory leverages a JGA). If a SEP stage is discarded at  $\sim 5 \text{ AU}$ , its performance can be evaluated at arbitrarily large solar distances by angling the solar panels relative to the Sun, potentially certifying solar power for solar distances beyond Jupiter for future missions.

### Approach to Neptune

The approach to Neptune consists of four critical phases of the mission: separation of atmospheric probe (SEP), execution of divert maneuver (DM), establishment of communication with the atmospheric probe during descent (Link), and NOI.

The atmospheric probe separation consists of releasing the atmospheric probe along the spacecraft trajectory 30 days from current time of closest approach. This ballistic trajectory has been designed to attain the desired atmospheric entry conditions for the probe. Although it requires no deterministic  $\Delta\text{-V}$  to target probe entry conditions, it enables the execution of statistical maneuvers that may be needed to fine-tune probe atmospheric entry.

Fifteen days after probe separation, the spacecraft executes a DM to extend its time of closest approach by 1 h and raise its altitude of closest approach to 2000 km above Neptune. The resulting relative geometry between spacecraft and probe enables establishing a strong communication link before atmospheric entry and during atmospheric descent. After atmospheric descent, the spacecraft reaches closest approach to Neptune and executes the NOI.

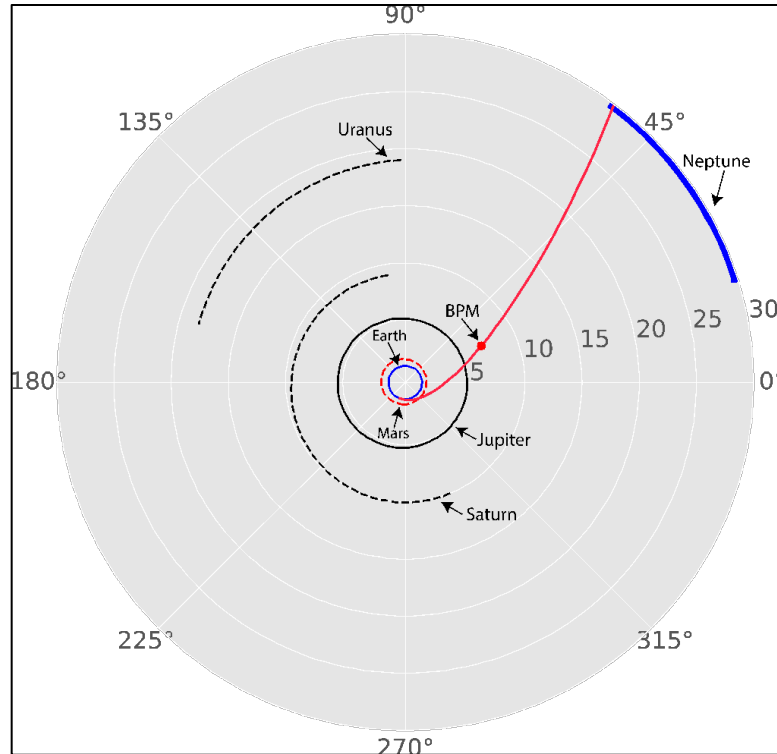

**Figure 3.4. *Odysseey's 20-year journey and the locations of the planets during the time 2033–2053. BPM = Broken-plane maneuver.***

## Neptune Orbit Insertion

To capture into an elliptical orbit around Neptune, the flight system executes NOI, a 946 m/s maneuver at a closest-approach altitude of 2000 km above Neptune, resulting in an orbit with a period of 213.5 days. At the apoapsis of this orbit—106.7 days after NOI over 7 million kilometers above Neptune—a 350 m/s periapsis raise maneuver (PRM) is executed that targets the first encounter in the Triton tour on February 21, 2050, with an incoming  $v_\infty$  of 3.72 km/s.

## Triton Tour

The Triton tour consists of 46 flybys of Triton. Each flyby imparts a large  $\Delta$ -V to the spacecraft that is used in conjunction with small deterministic maneuvers to target the next Triton flyby. Strung in this manner, the multiple flybys result in a trajectory that provides near-global coverage of Triton while remaining in orbit around Neptune. As such, this trajectory provides the opportunity to investigate both Neptune and Triton from a common vantage point without the need to capture into an orbit around Triton.

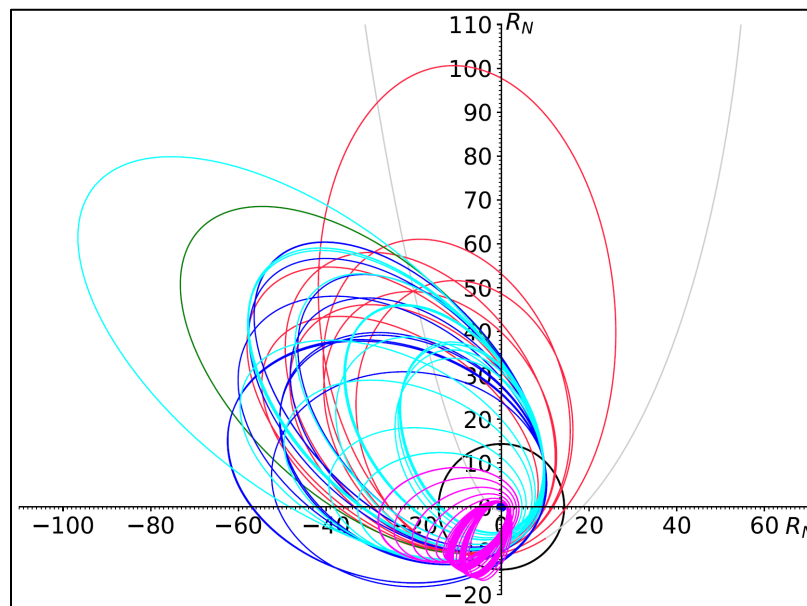

**Figure 3.5.** *Odyssey's 4-year tour of Neptune and Triton (Triton orbit is shown in black, and the axes are in units of Neptune radii). Capture orbit: gray, Phase 1; red, Phase 2; green, Phase 3; blue, Phase 4; cyan, Phase 5; magenta, Phase 6 and end.*

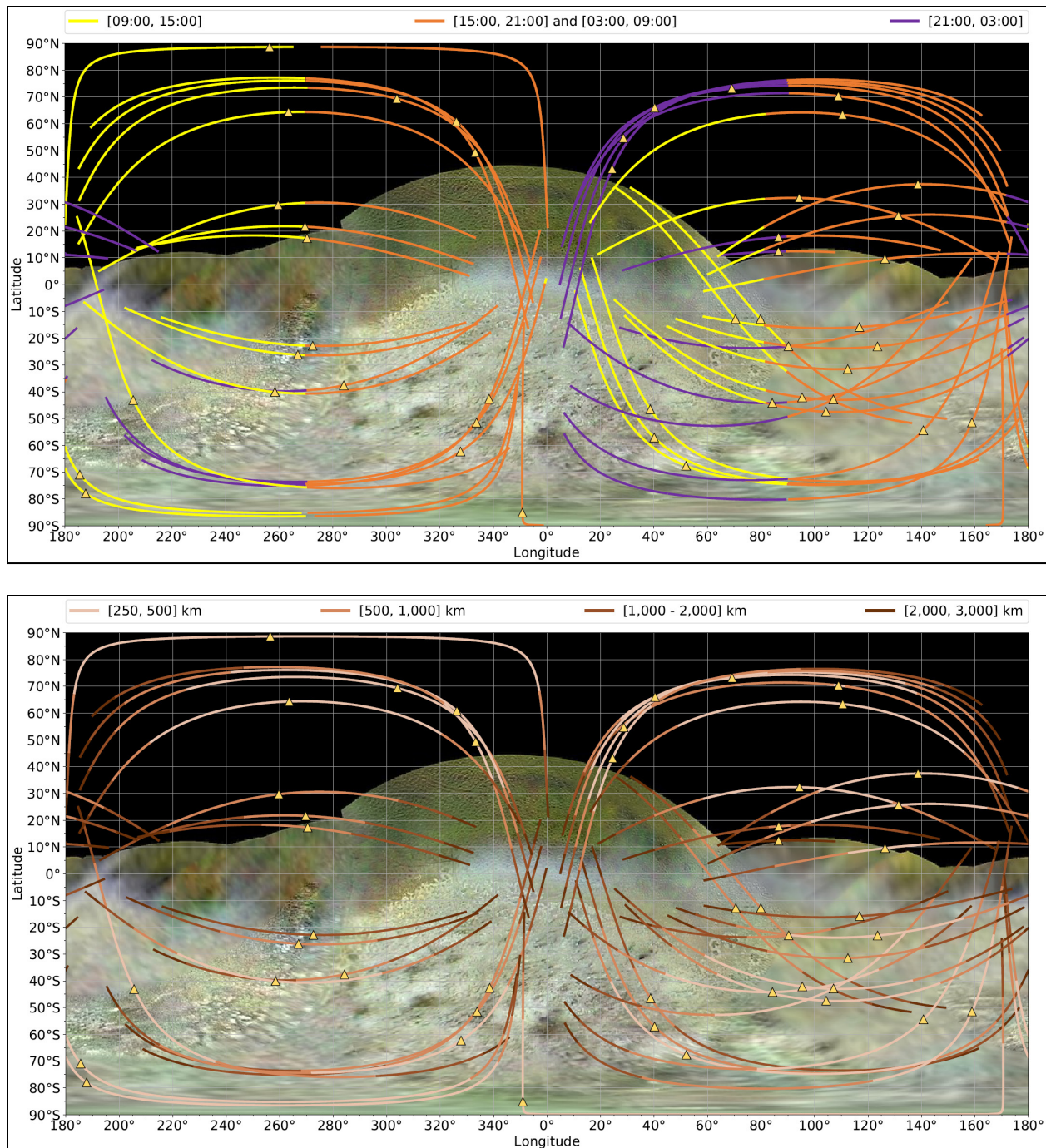

**Figure 3.6. Ground coverage achieved by Odyssey at Triton, colored by light level (time of day) (top) and distance from the surface (bottom). Yellow triangles indicate the closest approach distance. The background image shows Triton's surface as observed by Voyager 2.**

The tour is divided into five phases. First (red on [Figure 3.5](#)) is the *Pump-Down Phase*, which consists of a 641-km-altitude flyby that reduces the orbital period and establishes the cadence for the remainder of the tour. Second (green) is a series of Triton flybys with alternating 4:1 and 5:1 resonances that cover the sub-Neptune hemisphere. Third (blue) follows a transfer maneuver that

brings the spacecraft on the diametrically opposite side of Neptune to enable anti-Neptune hemisphere coverage. Fourth (cyan) is a series of 10 flybys with alternating 4:1 and 5:1 resonances that cover the anti-Neptune hemisphere. Fifth (magenta) is a series of 20 fast transfers that reduce the orbital period, bring the spacecraft near the rings, and stage the last six encounters that reduce Neptune periapsis to very low altitudes, ultimately resulting in safe spacecraft disposal via Neptune atmospheric entry. The resulting trajectory leads to ground tracks at Triton that cover both northern and southern latitudes at all longitudes with a variety of illumination conditions. [Table 3.6](#) presents a summary of the  $\Delta$ -V required by phase.

**Table 3.6.  $\Delta$ -V summary table by phase.**

Name	$\Delta$ -V (m/s)
Trans-Neptunian injection	8,631.332
Broken-plane maneuver	245.282
Divert maneuver	15.089
NOI	946.242
PRM	350.000
Tour	50.136

## Probe Deployment

The entry probe trajectory design leveraged past probe missions to dense atmospheric bodies. The entry vehicle selected was a 1.26-m-diameter, 45° sphere-cone, which has been used in the past at Venus and Jupiter and has demonstrated high static stability during the entry portion of the EDL design. A blunt nose radius (0.4-m) was chosen to limit peak aerothermal environments on the stagnation point and thereby reduce the TPS thickness and mass required. The 275-kg probe will be released from the carrier spacecraft 30 days before atmospheric entry, and the inertial entry flight path angle would be targeted to be  $-17.8^\circ$ . The choice of the entry flight angle was determined after a trade of peak sensed acceleration, peak heat flux, peak stagnation pressure, and the TPS size based on total heat load. Because of Neptune’s thick atmosphere, the vehicle achieves maximum acceleration of 156 Earth g’s  $\sim 2.5$  min after atmospheric interface and achieves a peak heat flux of 5470 W/cm<sup>2</sup>, which is within the expected capabilities of the HEEET TPS, which was recently developed by NASA for outer-planet (and Venus) missions (EDL 5).

The vehicle reaches subsonic conditions 3.5 min after entry, and at this point a mortar deploys a 2.5-m conical ribbon parachute at Mach 0.8, dynamic pressure of 3000 Pa, and an altitude of 43 km (altitude  $>1$  bar pressure level). Conical ribbon parachutes have long heritage for planetary missions, having been used for Venus and Jupiter (EDL 3 and EDL 4), and the mortar deployment conditions are well within conditions seen in other planetary entries. The first parachute decelerates to low subsonic speeds, where the heat shield is jettisoned 15 s after the parachute deployment at Mach 0.44. The first parachute is still attached to the backshell and the descent probe, allowing for a smaller ballistic coefficient while the heat shield and its higher ballistic coefficient vehicle can separate away at rates similar to other planetary entry missions.

After the heat shield has had sufficient separation from the rest of the vehicle, the descent probe and a second smaller, 1.5-m ringsail parachute separate from the backshell and first parachute system. The descent probe separation occurs 30 s after the heat shield separation, at Mach 0.3, and an altitude of 35 km. Once again, the two stages have a positive separation rate because of ballistic coefficient difference.

Data start being received at the spacecraft  $\sim 5$  min after atmospheric entry. After backshell separation, the probe descends under the second parachute until it reaches 1-bar pressure level at 10 min after entry and reaches the mission goal target of 10-bar  $\sim 37$  min after entry. Once the vehicle is under parachute, it continues to have good visibility to the orbiter, with off-zenith angles improving until shortly before the orbiter’s NOI burn  $\sim 60$  min after the probe’s atmospheric entry. At this point, the probe is at 22-bar atmosphere.



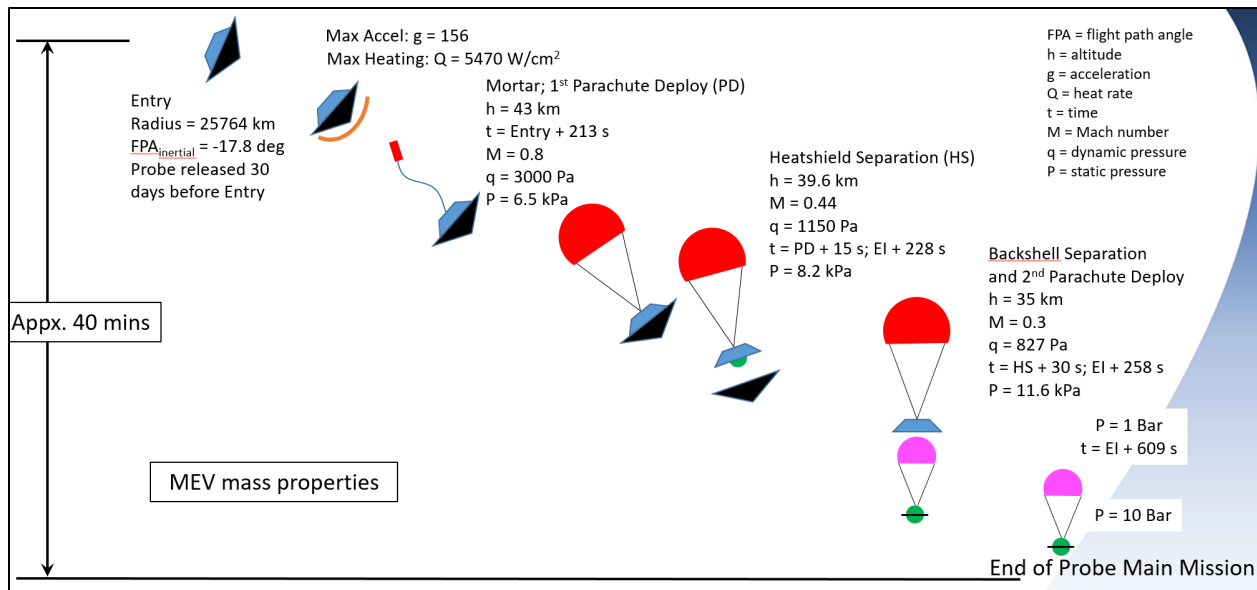

**Figure 3.7. Probe trajectory and concept of operations.**

An overview of mission operations and the Mission Operations and Ground Data Systems Table are located in the [Concept of Operations](#) section in Appendix B.

## Risk Analysis

The top risks have identified likelihood and consequence levels along with a summarized mitigation strategy ([Table 3.7](#)).

**Table 3.7. Odyssey risk list.**

**L is “Likelihood” and C is “Consequence” of the risk from 1 (lowest) to 4 (highest).**

#	Risk	Type	L	C	Mitigation
1	If plutonium supplies are insufficient, then launch readiness date will be impacted.	Schedule	4	4	Mitigation is external to Odyssey
2	If NGRTG availability is not as expected, then alternatives will need to be identified to minimize impact to mission, cost, and schedule.	Technical, Cost & Schedule	3	4	Work with NASA to develop demonstrator
3	If the SLS Block 2 and Centaur upper stage are not available as expected, then alternative launch vehicles would need to be considered.	Technical	3	3	Consider alternative launch vehicle and solar electric propulsion kickstage
4	If probe communications through NOI operations cannot be maintained, then the current mission may need to be changed to increase the time between probe operations and NOI.	Technical	2	2	Consider alternatives for articulating the antenna to reduce complex geometry Model and test communications system
5	If peak acceleration loads have a large impact on the probe design, then mission cost could be impacted.	Cost	2	3	Qualify systems for the environment
6	If system reliability is not shown to be adequate for a long mission, then cost will be impacted.	Cost	1	3	Perform reliability analysis and assess alternatives Provide additional redundancy
7	If attitude control system reliability is not shown to be adequate for the mission, then redundancy and other accommodations will need to be added.	Technical	2	3	Add extra wheels Use both wheels and thrust for attitude control

#	Risk	Type	L	C	Mitigation
8	If system reliability is not shown to be adequate for a long mission, then redundancy and other accommodations will be needed.	Technical	3	3	Perform increased reliability testing and analysis
9	If accommodation of the large number of instruments is more complex than expected, then cost and schedule may be impacted.	Cost & Schedule	2	2	Identify risk mitigation activities in Phase A to be executed in Phase B

**Table 3.8. Odyssey risk matrix.**

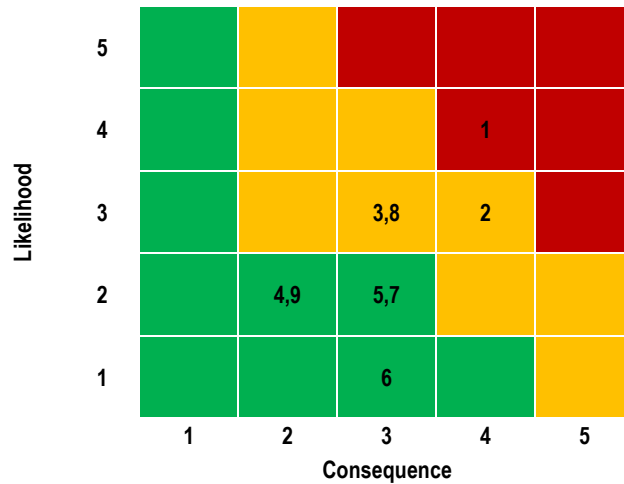

## 4. Development Schedule and Schedule Constraints

### High-Level Mission Schedule

The high-level mission schedule included in [Figure B.10](#) is based on previous schedules for relevant missions and proposed missions in the same class. These were identified as a good approximation of the anticipated schedule for the Neptune Odyssey mission.

**Table 4.1. Key phase duration table.**

Project Phase	Duration (Months)
Phase A – Conceptual Design	13
Phase B – Preliminary Design	15
Phase C – Detailed Design	24
Phase D – Integration and Testing	30
Phase E – Primary Mission Operations	236
Phase F – Final Analysis and Archiving	12
Start of Phase B to Preliminary Design Review (PDR)	16.5
Start of Phase B to Critical Design Review (CDR)	27
Start of Phase B to Delivery of Instrument #1 (Orbiter Instrument Payload)	42
Start of Phase B to Delivery of Instrument #2 (Probe Instrument Payload)	36
Start of Phase B to Delivery of Flight Element #1 (Orbiter)	46
Start of Phase B to Delivery of Flight Element #2 (Probe)	46



Project Phase	Duration (Months)
System-Level Integration and Testing	
Orbiter	5.5
Probe	5
<u>System</u>	+20
Total	30.5
Project Critical Path Schedule Reserve	7.95
Total Development Time, Phases B–D	69

## Development Schedule and Constraints

In the development schedule contained within [Figure B.10](#), both payload and flight systems are broken down into respective orbiter and probe components. The schedule contains a total of 32 weeks of critical path schedule reserve and includes identification and early order of long lead materials. The schedule aligns with a launch window of May 16, 2033, through June 4, 2033. Later launch opportunities exist. Moving to a later launch date would result in additional duration and cost for Phase E. Noteworthy external schedule dependencies (constraints) include timely availability of sufficient plutonium for RTGs; timely availability of sufficient plutonium or other radioisotope material for RHUs; timely availability of required heavy-lift launch services, including LV and compatible upper stages; and timely availability of facilities for environmental testing of the orbiter and orbiter/probe combined unit.

## 5. Mission Life-Cycle Cost

### Introduction

Neptune Odyssey cost estimates are based on a CML 4 mission concept. The payload and spacecraft estimates capture the resources required for the defined point design. Estimates take into account subsystem-level mass, power, and risk. In many instances, they also take into account the technical and predicted performance characteristics of preferred components. Estimates for science, mission operations, and ground data system elements whose costs are primarily labor reflect Phase A–D schedules and Phase E/F timelines.

The mission estimate is comprehensive and representative of expected expenditures for a Neptune mission executed as described above. As this section describes, it is consistent with cross-check model results and the costs of analogous activities, hardware, and software. The estimated Phase A–F mission cost in fiscal year 2025 dollars (FY25\$) with unencumbered cost reserves of 25% on Phases E/F is \$3.395B, including LV and services. The estimated baseline mission cost without reserves is \$2.664B (see [Table 5.1](#)).

### Mission Ground Rules and Assumptions

The mission ground rules and assumptions are presented in the [Mission Life-Cycle Costs](#) section of Appendix B. They are derived from the November 2019 “Decadal Mission Study Ground Rules.”

## Cost Benchmarking

The estimated cost of the Neptune Odyssey mission is comparable to those of many NASA Flagship-class planetary missions, both completed and now being built, after LV and services are excluded. For example, its estimated cost with unencumbered reserves of \$2.737B is in line with the \$2.8B cost in FY25 dollars of the Cassini mission to Saturn, which included the Huygens probe that landed on Titan (see [Figure 5.1](#)).

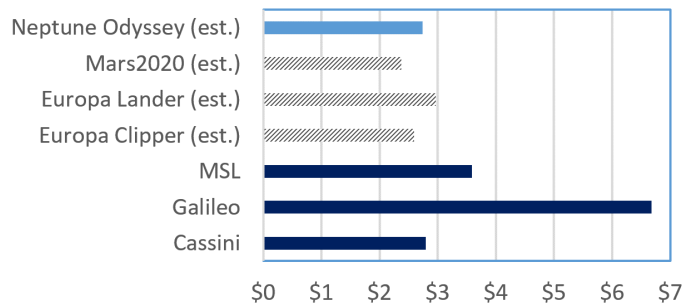

**Figure 5.1. Mission cost comparison to other Flagship missions, excluding launch vehicle costs (in billions of FY25 dollars).**

## Cost Estimate

The Neptune Odyssey CML-4 mission cost estimate results from the merger of parametric cost model results, bottom-up estimates (BUEs), and cost histories of analogous items. The estimate incorporates technical and cost uncertainties in the estimating process and includes unencumbered cost reserves of 25% for Phases A–D and 25% for postlaunch Phases E and F. No attempt was made to remove the costs due to manifested risks from the heritage data or model results. In other words, before reserves are applied, the baseline estimate already includes a historical average of cost risk. This non-adjustment is appropriate for capturing risk and uncertainty commensurate with early formulation stages of a mission. [Table 5.1](#) shows primary and cross-check cost estimates in FY25\$ for the work breakdown structure (WBS) level-2 elements of Phases A–D of the Neptune orbiter mission. Spacecraft cost estimates are parametrically derived and reported by level-3 element (stage). Adjustment for unencumbered cost reserves is reported at the bottom of the table.

**Table 5.1. Estimated cost of Neptune Odyssey mission (in thousands of FY25 dollars).**

WBS	Description	Primary Costing Method	Cost Using Primary Method \$FY25K	Cross-Check Method	Cost Using Cross-Check \$FY25k	Remarks
A	Phase A	Ground Rule	\$24,880	Ground Rule	\$23,628	2% of Phase B–D baseline cost, excluding WBS 08
01	Project Management (PM)	Historical Factor	\$39,638	Historical Factor	\$38,286	Cost factor (15.9%) of WBS 05, 06, and 10 baseline costs, derived from APL New Horizons, Van Allen Probes, Parker Solar Probe mission cost histories. PM covers implementing institution's NEPA compliance activity. Mission SE includes prelaunch mission analysis activities.
02	Systems Engineering (SE)	Historical Factor	\$60,250	Historical Factor	\$58,195	
03	Safety and Mission Assurance	Historical Factor	\$58,664	Historical Factor	\$56,664	
04	Science	BUE	\$38,358	MESSENGER Analogy	\$17,095	WBS covers 15 FTEs (B–D) including PI and PS, Science Operations Center (SOC) development, prelaunch SciBox updating
05	Payloads	Roll-up	\$443,826		\$424,557	Roll-up

WBS	Description	Primary Costing Method	Cost Using Primary Method \$FY25K	Cross-Check Method	Cost Using Cross-Check \$FY25k	Remarks
05.01-03	Payload PM/SE/MA	Historical Factor	\$33,636	Historical Factor	\$32,175	8.5% cost factor applied to payload costs is derived from APL Van Allen Probes, Parker Solar Probe, New Horizons, MESSENGER cost histories
05.04+	Orbiter Instruments	See table	\$356,192	See table	\$332,636	Primary estimates: NICM VIII system-level estimates. Cross-checks: analogous instrument costs, SEER-SPACE estimates
PP.04+	Probe Instruments	See table	\$53,998	See table	\$59,746	
<b>06</b>	<b>Flight System</b>	<b>Roll-up</b>	<b>\$440,987</b>	<b>Roll-up</b>	<b>\$430,081</b>	<b>Roll-up</b>
06.01	Orbiter Spacecraft	TruePlanning Est.	\$349,001	SEER-H Est.	\$347,145	CBE inputs to TP model. Assumes vendor contracts for Orbiter RCS and aeroshell. Orbiter includes \$120M to NASA for 3 NGRTGs; probe, \$5.7M to NASA for RHUs.
06.02	Thermal Protection System (for probe)	TruePlanning Est.	\$42,929	SEER-H Est.	\$41,177	
06.03	Probe Spacecraft	TruePlanning Est.	\$49,057	SEER-H Est.	\$41,759	
07	MOps System (B–D)	TruePlanning Est.	\$32,890	Analogy (New Horizons)	\$29,311	Phases A–D only. Estimates incl. \$8.5M for prelaunch operations and \$10.3M for postlaunch operations through checkout.
08	Launch Vehicle and Services	Guidance + ROMs	\$658,000	Guidance + ROMs	\$658,000	Includes \$500M for SLS Block 2 LV, \$40M for Centaur upper stage, \$80M for 8.7-m-diameter fairing, and \$38M for use of RTGs & RHUs
09	Ground Data Systems	BUE	\$17,017	Analogy (New Horizons)	\$18,676	BUE accounts for hardware, software, licenses for proven mission-independent architecture. Cross-check based on New Horizons cost after adding costs for IT systems administration, testbed software from Van Allen Probes.
10	Integration and Testing (I&T)	Cost factor	\$112,371	Cost factor	\$108,539	Primary estimate uses cost-to-cost factor of 12.7% on WBS 05 and 06 costs
<b>Phases A–D Baseline</b>			<b>\$1,926,880</b>		<b>\$1,863,033</b>	<b>Point estimate including Phase A (2% of B–D, excl. WBS 08)</b>
Phases B–D Reserves			\$571,590	50% on baseline	\$539,667	50% reserves on Phases B–D baseline, excl. LV&S, eMMRTGs, and RHUs
<b>Phases A–D with Reserves</b>			<b>\$2,498,471</b>		<b>\$2,402,700</b>	
<b>Phases E, F Baseline</b>			<b>\$717,521</b>			<b>MOCET estimate for labor + BUE for GSD refreshment + ROM for Phase F labor. Excludes DSN charges</b>
Phases E, F Reserves			\$179,380	25% on baseline		25% reserves on Phases E, F
<b>Phases E, F with Reserves</b>			<b>\$896,901</b>			
<b>Phases A–F Baseline</b>			<b>\$2,644,401</b>			
Phases A–F Reserves			\$750,970			
<b>Phases A–F with Reserves</b>			<b>\$3,395,372</b>			

WBS	Description	Primary Costing Method	Cost Using Primary Method \$FY25K	Cross-Check Method	Cost Using Cross-Check \$FY25k	Remarks
Phases A–F with Reserves, excluding LV&S			\$2,737,372			

## Confidence and Cost Reserves

Per the Planetary Mission Concept Studies Headquarters (PMCS HQ) Ground Rules, added to the baseline cost estimate are unencumbered cost reserves of 50% to all Phase A–D elements except for Launch Vehicle and Services, RTGs, and RHUs (whose prices are set by NASA) and cost reserves of 25% to Phase E–F elements, excluding DSN charges. A probabilistic cost risk analysis was conducted that accounts for historical cost growth of APL nuclear- and non-nuclear-powered spacecraft at the subsystem level, the effect of uncertainty in instrument specifications and design heritage on final payload cost, and commensurate growth for project management, systems engineering, and mission assurance (PM/SE/MA) and system integration and testing (I&T) activities.

**Table 5.2. Neptune mission confidence levels, based on cost risk analysis.**

Description	Value (FY25 \$M)	Confidence Level
Point Estimate, Phases A–F	\$2,644	48%
Mean	\$2,838	
Standard Deviation	\$777	
Coefficient of Variation (CoV)	0.27	
Unallocated Cost Reserves (50% Phases A–D/25% Phases E/F)	\$751	
Mission Cost with Reserves	\$3,395	79%
Mission Cost with 30%/15% Unallocated Reserves	\$2,876	64%

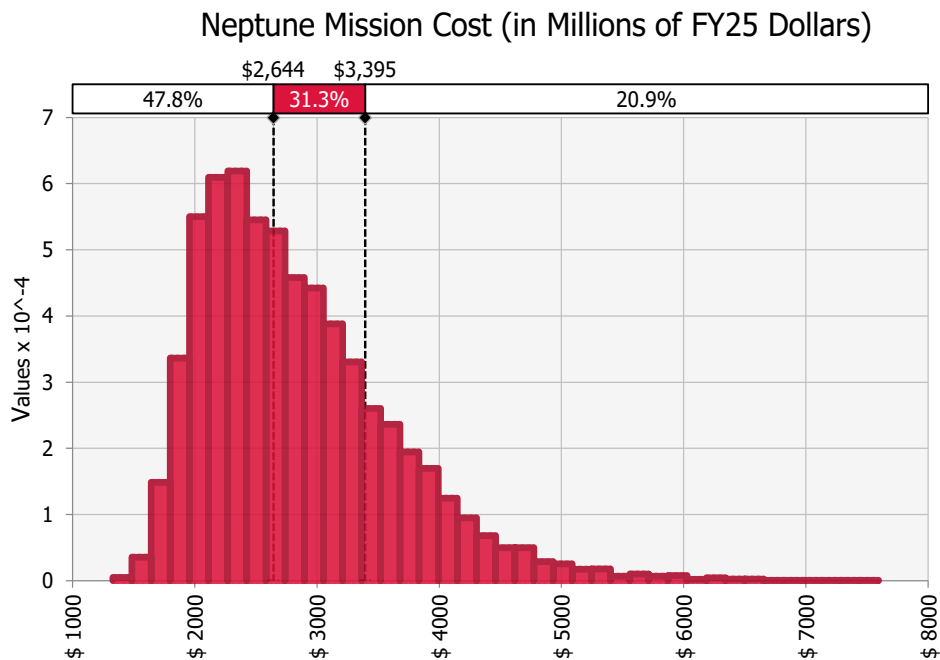

**Figure 5.2. Cost risk analysis results (S curve) for Neptune mission, Phases A–F.**

# Appendix A. Acronyms and Glossary of Terms

ACS	Attitude Control Subsystem
APL	Johns Hopkins Applied Physics Laboratory
ASI	Atmospheric Structure Instrument
BOE	Basis of Estimate
BOM	Beginning of Mission
BPM	Broken-Plane Maneuver
BUE	Bottom-Up Estimate
C&DH	Command and Data Handling
CBE	Current Best Estimate
CCHP	Constant Conductance Heat Pipe
CDR	Critical Design Review
CFD	Computational Fluid Dynamics
CIVA	Comet Infrared and Visible Analyser
CML	Concept Maturity Level
COTS	Commercial Off-the-Shelf
DART	Double Asteroid Redirection Test
DM	Divert Maneuver
DPLR	Data Parallel Line Relaxation
DSAD	Digital Solar Aspect Detector
DSN	Deep Space Network
EDL	Entry, Descent, and Landing
EDS	Entry and Descent Stage
EM	Engineering Model
ENA	Energetic Neutral Atom
EOM	End of Mission
EPI	Energetic Particle Instrument (EPI-Lo)
EPS	Electrical Power System
ESI	Engineering Science Investigation
ETU	Engineering Test Unit

FOV	Field of View
FPGA	Field-Programmable Gate Array
FSW	Flight Software
FY	Fiscal Year
G&C	Guidance and Control
GNC	Guidance, Navigation, and Control
GPHS	General Purpose Heat Source
GSE	Ground Support Equipment
H&S	Health and Status
HAD	Helium Abundance Detector
HEEET	Heatshield for Extreme Entry Environment Technology
HGA	High-Gain Antenna
I&T	Integration and Testing
IBEX	Interstellar Boundary Explorer
IDEX	Interstellar Dust Explorer
IEM	Integrated Electronics Module
IMAP	Interstellar Mapping and Acceleration Probe
INMS	Ion and Neutral Mass Spectrometer
IR	Infrared
ISM	Interstellar Medium
JGA	Jupiter Gravity Assist
JPL	Jet Propulsion Laboratory
LGA	Low-Gain Antenna
LORRI	Long Range Reconnaissance Imager
LRO	Lunar Reconnaissance Orbiter
LV	Launch Vehicle
MEL	Master Equipment List
MEOP	Maximum Expected Operating Pressure
MESSENGER	MErcury Surface, Space ENvironment, GEOchemistry, and Ranging
MEV	Maximum Expected Value
MGA	Medium-Gain Antenna
MiSC	Mission-Specific Card
MLA	Mercury Laser Altimeter



MLI	Multilayer Insulation
MOCET	Mission Operations Cost Estimating Tool
MPV	Maximum Possible Value
MSIM	Mission Simulation
MWR	Microwave Radiometer
NASA	National Aeronautics and Space Administration
NEPA	National Environmental Policy Act
NGRTG	Next-Generation Radioisotope Thermoelectric Generator
NICM	NASA Instrument Cost Model
NIR	Near Infrared
NOI	Neptune Orbit Insertion
NRE	Nonrecurring Engineering
PDB	Propulsion Diode Boxes
PDR	Preliminary Design Review
PEL	Power Equipment List
PI	Principal Investigator
PICA	Phenolic Impregnated Carbon Ablator
PM	Project Management
PMCS HQ	Planetary Mission Concept Studies Headquarters
PMD	Propellant Management Device
PM/SE/MA	Project Management, Systems Engineering, and Mission Assurance
PRM	Periapsis Raise Maneuver
PS	Project Scientist
PSU	Power-Switching Unit
RF	Radio Frequency
RHU	Radioisotope Heater Unit
RIU	Remote Interface Unit
ROM	Rough Order of Magnitude
RTG	Radioisotope Thermoelectric Generator
RWA	Reaction Wheel Assembly
SCIF	Spacecraft Interface Card
SE	Systems Engineering
SEP	Solar Electric Propulsion

SLS	Space Launch System
SNAP	Small Next-generation Atmospheric Probe
SOC	Science Operations Center
SOMA	Science Office for Mission Assessments
SSPA	Solid-State Power Amplifier
SSR	Solid-State Recorder
STM	Science Traceability Matrix
SWRI	Southwest Research Institute
3D	Three-Dimensional
TAC	Thruster/Actuator Controller
TBD	To Be Determined
TCM	Trajectory-Correction Maneuver
TNI	Trans-Neptunian Injection
TPS	Thermal Protection System
TRL	Technology Readiness Level
TVAC	Thermal Vacuum
UHF	Ultrahigh Frequency
USO	Ultra-Stable Oscillator
UV	Ultraviolet
V&V	Verification and Validation
WBS	Work Breakdown Structure
WG	Working Group
$\Delta$ -V	Change in spacecraft speed due to a maneuver or flyby [length/time]
$v_{\infty}$	Magnitude of hyperbolic excess velocity vector [length/time]
$C_3$	Characteristic energy (for hyperbolic orbits, $C_3 \equiv v_{\infty}^2$ ) [length <sup>2</sup> /time <sup>2</sup> ]

# Appendix B. Design Team Study Report

## High-Level Mission Concept

This is the background and additional detail that supports the science objectives section of the main report.

**Table B.1. Concept maturity level definitions.**

Concept Maturity Level	Definition	Attributes
CML 6	Final Implementation Concept	Requirements trace and schedule to subsystem level, grassroots cost, verification and validation (V&V) approach for key areas
CML 5	Initial Implementation Concept	Detailed science traceability, defined relationships and dependencies: partnering, heritage, technology, key risks and mitigations, system make/buy
CML 4	Preferred Design Point	Point design to subsystem-level mass, power, performance, cost, risk
CML 3	Trade Space	Architectures and objectives trade space evaluated for cost, risk, performance
CML 2	Initial Feasibility	Physics works, ballpark mass and cost
CML 1	Cocktail Napkin	Defined objectives and approaches, basic architecture concept

## Trade Study Summary Data

[Table B.2](#) below summarizes results of some key mission elements investigated.

**Table B.2. Mission element summary (mass, power, LV, tour and cost).**

Mass (CBE)	Power	Launch Vehicle	Tour	Cost
Wet 1648 kg Dry 1594 kg Total = 3288 kg SLS Block 2 + kickstage (+ broken-plane maneuver) launch capability = 4958 kg FH + SEP can match this depending on SEP selected (P0) Payload mass = 214 kg Probe mass = 220 kg	3 Next-Generation Radioisotope Thermoelectric Generators (NGRTGs) (max) NGRTGs come in various configurations: Select 16 GPHS module configuration 4 clads per module = 192 clads 1 clad = 0.15 kg Pu 192 clads = 28.8 kg Pu 17 kg Pu existing + (surged) Pu production ~3.75 kg/year =~ 3.5 years for needed Pu production	SLS Block 2 + kickstage launch capability = 4958 kg [NB: Falcon Heavy + SEP or SLS + SEP can achieve the same, but we selected SLS + Centaur for point design.] Delta IV heavy is an option if we include Jupiter gravity assist (JGA) (launch before 2032)	Probe deployed at NOI Contact with probe for 30 minutes End contact with probe 10 minutes before burn Tour duration 4 years, 32 orbits 46 Triton flybys CA minimum 250 km Avoid ~1.4–1.7 Rn in equatorial plane because of ring hazard Closest approach to Neptune 2000 km End of mission – final plunge into Neptune Identify cruise phase opportunities: Solar system planets Asteroid Centaur	<\$3.5B

## Triton Lander Study

The original Neptune Odyssey proposal explicitly excluded a Triton lander element given the risks associated with Triton’s unknown surface properties. However, the review panel found this intentional omission to be a minor weakness. To address this minor weakness, we considered two alternative Triton surface elements in the early point design study: a traditional static lander and an

impactor. The impactor concept would have lofted shallow subsurface material into Triton’s atmosphere for possible detection by the orbiter’s mass spectrometer; while this approach was promising and was presented to and received favorably by planetary protection [Pratt et al., private communication, February 2020], it was deemed to present some risk to the orbiter (because of close Triton approach) and, given the mass of the deployable and possibility of ambiguous science return, the cost/risk/science benefits were deemed less favorable than using the mass to optimize the spacecraft payload for remote observation of Triton. Based on the high science priority of having a Neptune atmospheric entry probe and the inability to accommodate both a probe and a lander, we made the decision to delete the lander from the point design.

## Launch Vehicle Trades

SEP considerations: Like the Centaur upper stage, SEP provides an energy boost that is equivalent to a Jupiter gravity assist (JGA).

An advantage of using SEP would be to evaluate and qualify technology for deep-space, long-duration missions. The Juno spacecraft took the opportunity to tilt the solar panels at 5 AU (Jupiter) to emulate the power expected at 10 AU. A SEP-powered Odyssey could do the same farther out to qualify solar power use for even deeper space missions.

## Technical Overview

[Table B.3](#) provides a brief “plain English” description of the instrument suite for the orbiter.

**Table B.3. Orbiter instrument payload “plain English” descripts.**

Instrument Type	Heritage Instrument	
Color Narrow Angle Camera	New Horizons LORRI Visible imager	This high-heritage camera is a highly capable digital camera/telescope optimized to capture telescopic images as they would be observed by the human eye—optimized for the low light levels at 30 AU. Images of Triton, Neptune, the aurora, small moons, and any other objects will be obtained.
UV Imaging Spectrograph	New Horizons Alice	Imager (camera) with multiple wavelength ranges in the ultraviolet (UV). The spectrometer provides images and spectra across the UV range and will provide vital compositional information for Triton’s atmosphere and characterize the aerosols in Neptune’s atmosphere; the instrument will also take reflectometry measurements for Triton as well as conduct vital auroral activity monitoring for Neptune. Solar and stellar occultation ports will enable occultation measurements to derive thermospheric temperature of Neptune and contribute significantly toward resolving the so-called “thermospheric energy crisis.” These measurements are sensitive to sunlight and energetic particle contamination.
Vis-NIR Imaging Spectrometer	Lucy/Ralph (MVIC and LEISA extended to 5 μm)	Adds the ability to construct spectra as a function of wavelength from the visible to infrared wavelengths to analyze composition of, in particular, the Triton surface. NB: MVIC is a filter imager not a spectrometer.
Thermal Infrared Imager	LRO/Diviner	Extends our measurements further into the infrared to probe the thermal properties of Triton’s surface as well as thermal emissions of Neptune to infer the internal energy flux, which is critical to understanding Neptune’s thermal evolution.
Microwave Radiometer	Juno/Microwave Radiometer (MWR)	Radio that receives in the microwave (0.4–24 GHz) range. This is sensitive to the distribution of H <sub>2</sub> S, NH <sub>3</sub> , H <sub>2</sub> O, and other polar molecules. Will constrain the composition of Neptune’s atmosphere down to a few hundred bars.
Laser Altimeter	MESSENGER/MLA	Actively bounces light to the surface to make very accurate terrain readings. For mapping. Also for subsurface ocean determination via detection of equatorial bulge
Ion & Neutral Mass Spectrometer	Cassini/INMS	This instrument will take in situ measurements of the molecular/atomic composition near the spacecraft and provide vital measurements on the composition of Neptune and Triton as well as atmospheric loss, surface processes, and any variability due to possible plume activity.

Instrument Type	Heritage Instrument	
Dust Detector	IMAP/IDEX	This instrument will take in situ measurements of heavier particles near the spacecraft and provide vital measurements on the composition of large particles in the Neptune system.
Thermal Plasma Spectrometer	Juno/JADE-I (Minimum need 2, 3 desired)	This instrument will take in situ measurements of the low-energy (electronvolts to a few kiloelectronvolts) charged particle (ions, electrons, and negative ions) composition near the spacecraft and provide vital measurements on the composition of Neptune and Triton as well as atmospheric loss, surface processes, and any variability due to possible plume activity.
	Juno/JADE-E (Minimum need 2, 3 desired)	These measurements will also be used to compute the thermal plasma pressure contribution to the magnetic field in order to understand measurements of Triton's possible subsurface ocean. Need to be mounted away from magnetic sources on the spacecraft.
Energetic Neutral Atom Imager	Parker Solar Probe/EPI-Lo	Extends the plasma measurements to higher (kiloelectronvolts to megaelectronvolts) energies to make as complete spectral measurements of plasma composition as possible.  Important to assess surface weathering at the moons and vital for radiation belt physics. Voyager observed Neptune to have weaker radiation belts than other planets with comparable magnetic fields; this will address that mystery.
ENA (Energetic Neutral Atom) Imager	IMAP/Ultra	ENA imaging is a technique to detect energetic neutral atoms (ENAs) in order to construct a picture of the "neutral clouds" in which they were created. It is a clever and powerful technique that was used to great effect by Cassini for Saturn and to probe the outer edges of our Sun's astrosphere. It is not known whether Neptune has extensive neutral clouds. This instrument will discover that. Could contribute to cross-disciplinary science during the cruise phase.
Radio & Plasma Wave Detector	Juno/Waves	Radio receiver (antennas) (hertz to megahertz) with multiple applications, in situ and remote. Most importantly in practice: the in situ measurement of absolute electron density. Vital for magnetospheric science. Important diagnostic for moon activity via remote sensing. Can also detect dust via impacts creating electrostatic "noises." The instrument is also critical to detecting any lightning in the atmosphere, and contributes to understanding atmospheric circulation.
Magnetometer	MESSENGER/MAG (2 MAG sensors on boom)	Makes three orthogonal measurements of the magnetic field line direction in order to provide the magnetic field vector. Magnetic fields can't be remote sensed. Vital for constructing magnetic field maps and for the "induction" experiment at Triton.
Public Engagement Camera (Visible)	Rosetta/CIVA	Camera is mounted to provide contextual images that give a you-are-there perspective.

**Table B.4. Heritage Instrument List and Properties.**

Instrument	Quantity	Mass (kg), each	Total Mass (kg)	Power, Operational, (W)	Survival Power, (W)	Decontamination Power, (W)	Instrument Dimensions (L x W x H, mm), L x W Plane Is Perpendicular to Boresite	IR	Door/Deployment
New Horizons LORRI	1	8.60	8.60	5.00	0.4	10	13.5 x 45.5 x 17 cm	N	door
New Horizons Alice	1	4.35	4.35	5.00	0.4	1	13.5 x 45.5 x 17 cm	N	door
Lucy/Ralph (MVIC and LEISA extended to 5 μm)	1	31.00	31.00	24.00	15	24	TDA: 37.3 x 48.5 x 30.5 cm	Y: 0.4–5 μm	door
Diviner	1	10.00	10.00	16.00	30	20		Y	door
Cassini/INMS	1	9.25	9.25	23.30	4		20.3 x 42.4 x 36.5 cm	N	no
Juno/JADE-I (Minimum need 2, 3 desired)	3	5.24	15.72	1.00			18 x 24 x 22 cm	N	no
Juno/JADE-E (Minimum need 2, 3 desired)	3	7.55	22.66	1.90			21 x 21 x 21 cm	N	no
Parker Solar Probe/EPI-Lo	1	3.91	3.91	3.75	3.2	5.6		N	no
IMAP/Ultra	1	7.10	7.10	6.60					no
MESSENGER/MLA	1	7.40	7.40	25.00	10			N	no

Instrument	Quantity	Mass (kg), each	Total Mass (kg)	Power, Operational, (W)	Survival Power, (W)	Decontamination Power, (W)	Instrument Dimensions (L x W x H, mm), L x W Plane Is Perpendicular to Boresite	IR	Door/Deployment
Juno/Waves	1	12.68	12.68	8.10			2 electric antenna: 2.78 m long x 1.3 cm diameter 1 magnetic antenna: 15 cm long coil	N	antenna deployment x3
MESSENGER/MAG (2 MAG sensors on boom)	1	5.00	5.00	5.00	2		21.1 x 15.2 x 13.2 cm	N	2 Mag sensors on boom
Juno/Microwave Radiometer (MWR)	1	46.00	46.00	32.00			A1: 160 x 160 x 13.1 cm A2: 76.8 x 76.8 x 9.8 cm A3: 77.1 x 67.3 x 8.9 cm A4: 38.6 x 34.0 x 5.7 cm A5: 20.1 x 17.9 x 4.4 cm A6: 15.3 x 15.3 x 34 cm	N	no
EPO Cam	1	0.50	0.50	2.00	1.5		7 x 5.2 x 3.6 cm		
IMAP/IDEX	1	9.35	9.35	13.28				N	Still TBD for IMAP
Pivot	1	19.90	19.90	12.00				N	Still TBD for IMAP
<b>Column Totals</b>		<b>179.24</b>	<b>204.82</b>	<b>178.93</b>					

## Orbiter Payload Images

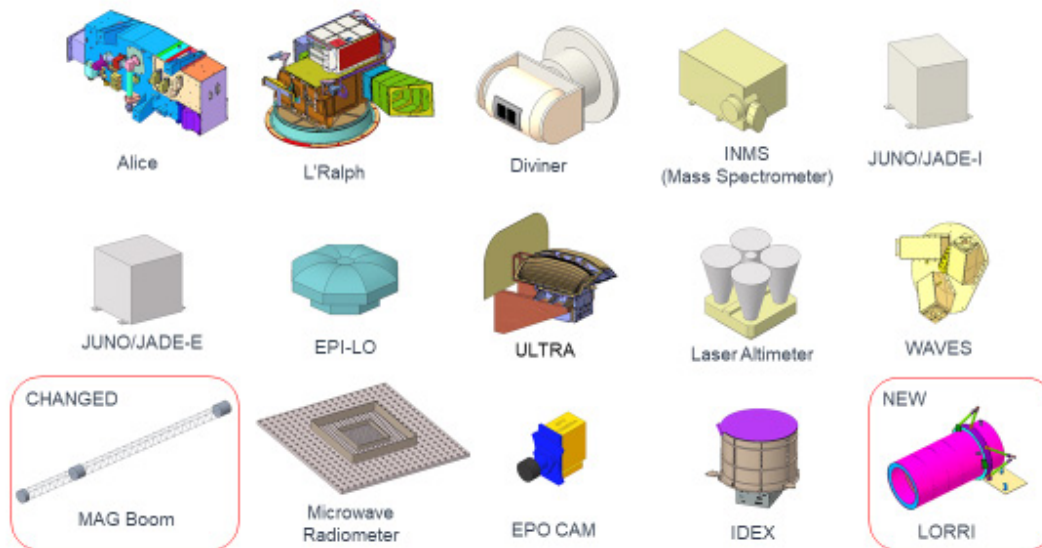

**Figure B.1. Summary of orbiter payload heritage.**



## Details for Each Orbiter Instrument

**Table B.5. Orbiter – Color Narrow-Angle Camera.**

Item	Value	Units
Spectral range	350 – 850	nanometers
Number of channels	~20 (with 2 filter wheels)	channels
Size/dimensions (for each instrument)	Cylinder 22 × 65	cm
Instrument mass <b>without</b> contingency (CBE)	8.6	kg
Instrument mass contingency	15	%
Instrument mass <b>with</b> contingency (CBE+Reserve)	9.9	kg
Instrument average payload power <b>without</b> contingency	5	W
Instrument average payload power contingency	15	%
Instrument average payload power <b>with</b> contingency	5.75	W
Instrument average science data rate <b>without</b> contingency	3.0	kbps
Instrument average science data rate contingency	15	%
Instrument average science data rate <b>with</b> contingency		kbps
Instrument FOVs (if appropriate)	0.29 × 0.29	degrees
Pointing requirements (knowledge)	0.011	degrees
Pointing requirements (control)	0.029	degrees
Pointing requirements (stability)	5.73E-4	degrees/second
Cost		\$M FY25
Heritage instrument	New Horizons LORRI	

**Table B.6. Orbiter – UV Imaging Spectrograph.**

Item	Value	Units
Spectral range	465-1881	angstroms
Number of channels	~157	channels
Size/dimensions (for each instrument)	13.5 × 45.5 × 17	cm × cm × cm
Instrument mass <b>without</b> contingency (CBE)	4.35	kg
Instrument mass contingency	15	%
Instrument mass <b>with</b> contingency (CBE+Reserve)	5.0	kg
Instrument average payload power <b>without</b> contingency	5	W
Instrument average payload power contingency	15	%
Instrument average payload power <b>with</b> contingency	5.75	W
Instrument average science data rate <b>without</b> contingency		kbps
Instrument average science data rate contingency		%
Instrument average science data rate <b>with</b> contingency		kbps
Instrument FOVs (if appropriate)	Slit: 4.0 × 0.1 SOC: 2 × 2	degrees
Pointing requirements (knowledge)	0.2	degrees
Pointing requirements (control)	0.4	degrees
Pointing requirements (stability)	0.57	degrees/second
Cost	15.1	\$M FY25
Heritage instrument	New Horizons Alice	

**Table B.7. Orbiter – Vis-NIR Imaging Spectrometer.**

Item	Value	Units
Spectral range	VIS-NIR: 0.4–0.975 IR Spec: 1.0–5.0	micrometers
Number of channels	VIS-NIR: 6 IR Spec: 1472	channels
Size/dimensions (for each instrument)	37.3 × 48.5 × 30.5	cm × cm × cm
Instrument mass <b>without</b> contingency (CBE)	31	kg
Instrument mass contingency	15	%
Instrument mass <b>with</b> contingency (CBE+Reserve)	35.65	kg
Instrument average payload power <b>without</b> contingency	24	W
Instrument average payload power contingency	15	%
Instrument average payload power <b>with</b> contingency	27.6	W
Instrument average science data rate <b>without</b> contingency		kbps
Instrument average science data rate contingency		%
Instrument average science data rate <b>with</b> contingency		kbps
Instrument FOVs (if appropriate)	VIS-NIR: 8.3 × 0.85 IR Spec: 4.6 × 3.2	degrees
Pointing requirements (knowledge)	0.4	degrees
Pointing requirements (control)	0.833	degrees
Pointing requirements (stability)	3.3E-3	degrees/second
Cost	60.6	\$M FY25
Heritage instrument	Lucy/Ralph (MVIC and LEISA)	

**Table B.8. Orbiter – Thermal IR Imager.**

Item	Value	Units
Spectral range	0.35 - 400	micrometers
Number of channels	9	channels
Size/dimensions (for each instrument)	37.3 × 48.5 × 30.5	cm × cm × cm
Instrument mass <b>without</b> contingency (CBE)	10	kg
Instrument mass contingency	15	%
Instrument mass <b>with</b> contingency (CBE+Reserve)	11.5	kg
Instrument average payload power <b>without</b> contingency	16	W
Instrument average payload power contingency	15	%
Instrument average payload power <b>with</b> contingency	18.4	W
Instrument average science data rate <b>without</b> contingency		kbps
Instrument average science data rate contingency		%
Instrument average science data rate <b>with</b> contingency		kbps
Instrument FOVs (if appropriate)	3.84 × 0.384	degrees
Pointing requirements (knowledge)	0.19	degrees
Pointing requirements (control)	0.384	degrees
Pointing requirements (stability)	0.384	degrees/second
Cost	29.3	\$M FY25
Heritage instrument	LRO Diviner	

**Table B.9. Orbiter – Ion and Neutral Mass Spectrometer.**

Item	Value	Units
Mass range	1-99	daltons
Number of channels	Scan-mode: 100 High-Res: 1.0E6	channels
Size/dimensions (for each instrument)	20.3 × 42.2 × 36.5	cm × cm × cm
Instrument mass <b>without</b> contingency (CBE)	9.25	kg
Instrument mass contingency	15	%
Instrument mass <b>with</b> contingency (CBE+Reserve)	10.6	kg
Instrument average payload power <b>without</b> contingency	23.3	W
Instrument average payload power contingency	15	%
Instrument average payload power <b>with</b> contingency	26.8	W
Instrument average science data rate <b>without</b> contingency	1.5	kbps
Instrument average science data rate contingency	15	%
Instrument average science data rate <b>with</b> contingency	1.73	kbps
Instrument FOVs (if appropriate)	Open Source: 8.6 half-angle cone Closed Source: 2 Pi	degrees steradians
Pointing requirements (knowledge)		degrees
Pointing requirements (control)		degrees
Pointing requirements (stability)		degrees/second
Cost	43.2	\$M FY25
Heritage instrument	Cassini INMS	

**Table B.10. Orbiter – Thermal Plasma Spectrometer - Ions.**

Item	Value	Units
Energy/mass range	Energy: 0.01–46.2 Mass: 1–50	keV amu
Resolution	Energy: 28 to 18 Mass: 2.5–11	%
Size/dimensions (for each instrument)	18 × 24 × 22	cm × cm × cm
Instrument mass <b>without</b> contingency (CBE*)	7.55	kg
Instrument mass contingency	15	%
Instrument mass <b>with</b> contingency (CBE+Reserve)	8.68	kg
Instrument average payload power <b>without</b> contingency	1.9	W
Instrument average payload power contingency	15	%
Instrument average payload power <b>with</b> contingency	2.2	W
Instrument average science data rate^ <b>without</b> contingency	0.576	kbps
Instrument average science data^ rate contingency	15	%
Instrument average science data^ rate <b>with</b> contingency	0.662	kbps
Instrument FOVs (if appropriate)	270 × 90	degrees
Pointing requirements (knowledge)		degrees
Pointing requirements (control)		degrees
Pointing requirements (stability)		degrees/second
Cost	17.9	\$M FY25
Heritage instrument	Jade-I	

**Table B.11. Orbiter – Thermal Plasma Spectrometer - Electrons.**

Item	Value	Units
Energy range	0.1–95	keV
Energy resolution	10.4–13.2	%
Size/dimensions (for each instrument)	21 × 21 × 21	cm × cm × cm
Instrument mass <b>without</b> contingency (CBE)	5.24	kg
Instrument mass contingency	15	%
Instrument mass <b>with</b> contingency (CBE+Reserve)	6.03	kg
Instrument average payload power <b>without</b> contingency	1	W
Instrument average payload power contingency	15	%
Instrument average payload power <b>with</b> contingency	1.15	W
Instrument average science data rate <b>without</b> contingency	0.128	kbps
Instrument average science data rate contingency	15	%
Instrument average science data rate <b>with</b> contingency	0.147	kbps
Instrument FOVs (if appropriate)	360 × 70	degrees
Pointing requirements (knowledge)		degrees
Pointing requirements (control)		degrees
Pointing requirements (stability)		degrees/second
Cost	17.9	\$M FY25
Heritage instrument	Jade-E	

**Table B.12. Orbiter – Energetic Particles Detector.**

Item	Value	Units
Energy range	Ions: 20 keV–15 MeV Electrons: 25–1000 keV	keV–MeV
Energy resolution	11	%
Size/dimensions (for each instrument)		cm × cm × cm
Instrument mass <b>without</b> contingency (CBE)	3.914	kg
Instrument mass contingency	15	%
Instrument mass <b>with</b> contingency (CBE+Reserve)	4.5	kg
Instrument average payload power <b>without</b> contingency	3.75	W
Instrument average payload power contingency	15	%
Instrument average payload power <b>with</b> contingency	4.31	W
Instrument average science data rate <b>without</b> contingency	3.1	kbps
Instrument average science data rate contingency	15	%
Instrument average science data rate <b>with</b> contingency	3.57	kbps
Instrument FOVs (if appropriate)	360 × 90	degrees
Pointing requirements (knowledge)		degrees
Pointing requirements (control)		degrees
Pointing requirements (stability)		degrees/second
Cost	15.5	\$M FY25
Heritage instrument	Parker Solar Probe EPI-Lo	

**Table B.13. Orbiter – Energetic Neutral Atom Imager.**

Item	Value	Units
Energy range	ENA: 3–300 keV; 5 MeV (ions) Electrons: 30–700 keV	keV–MeV
Energy resolution	≤14	%
Size/dimensions (for each instrument)		cm × cm × cm
Instrument mass <b>without</b> contingency (CBE)	7.1	kg
Instrument mass contingency	15	%
Instrument mass <b>with</b> contingency (CBE+Reserve)	8.2	kg
Instrument average payload power <b>without</b> contingency	6.6	W
Instrument average payload power contingency	15	%
Instrument average payload power <b>with</b> contingency	7.6	W
Instrument average science data rate <b>without</b> contingency	4	kbps
Instrument average science data rate contingency	15	%
Instrument average science data rate <b>with</b> contingency	4.6	kbps
Instrument FOVs (if appropriate)	MCP: 90 × 120 SSD: 70 × 120	degrees
Pointing requirements (knowledge)		degrees
Pointing requirements (control)		degrees
Pointing requirements (stability)		degrees/second
Cost	25.8	\$M FY25
Heritage instrument	IMAP Ultra	

**Table B.14. Orbiter – Laser Altimeter.**

Item	Value	Units
Spectral range	1064.5	nanometers
Number of channels	1	channels
Size/dimensions (for each instrument)	28 × 28 × 26	cm × cm × cm
Instrument mass <b>without</b> contingency (CBE)	7.4	kg
Instrument mass contingency	15	%
Instrument mass <b>with</b> contingency (CBE+Reserve)	8.5	kg
Instrument average payload power <b>without</b> contingency	25	W
Instrument average payload power contingency	15	%
Instrument average payload power <b>with</b> contingency	28.75	W
Instrument average science data rate <b>without</b> contingency	0.741	kbps
Instrument average science data rate contingency	15	%
Instrument average science data rate <b>with</b> contingency	0.852	kbps
Instrument FOVs (if appropriate)	0.023	degrees
Pointing requirements (knowledge)	0.0057	degrees
Pointing requirements (control)	0.0074	degrees
Pointing requirements (stability)	0.011	degrees/second
Cost	21.8	\$M FY25
Heritage instrument	MESSENGER MLA	

**Table B.15. Orbiter – Radio and Plasma Wave Detector.**

Item	Value	Units
Frequency range	Electric: few Hz–20 MHz Magnetic: few Hz–20 kHz	Hz to MHz Hz to kHz
Survey resolution	18	chan/decade
Size/dimensions (for each instrument)	E antenna: 2.78 m × 1.3 cm Mag antenna: 15 cm long	m × cm
Instrument mass <b>without</b> contingency (CBE)	12.7	kg
Instrument mass contingency	15	%
Instrument mass <b>with</b> contingency (CBE+Reserve)	14.6	kg
Instrument average payload power <b>without</b> contingency	8.1	W
Instrument average payload power contingency	15	%
Instrument average payload power <b>with</b> contingency	9.32	W
Instrument average science data rate <b>without</b> contingency	1.82	kbps
Instrument average science data rate contingency	15	%
Instrument average science data rate <b>with</b> contingency	2.09	kbps
Instrument fields of view (if appropriate)		degrees
Pointing requirements (knowledge)		degrees
Pointing requirements (control)		degrees
Pointing requirements (stability)		degrees/second
Cost	10.3	\$M FY25
Heritage instrument	Juno Waves	

**Table B.16. Orbiter – 3D Vector Magnetometer.**

Item	Value	Units
Magnetic range	Coarse: ±51,300 Fine: ±1530	nT
Magnetic resolution	Coarse: 1.6 Fine: 0.047	nT
Size/dimensions (for each instrument)	Sensor: 8.1 × 4.8 × 4.6 Boom: 10.5 m	cm × cm × cm
Instrument mass <b>without</b> contingency (CBE)	4.09	kg
Instrument mass contingency	15	%
Instrument mass <b>with</b> contingency (CBE+Reserve)	4.70	kg
Instrument average payload power <b>without</b> contingency	5	W
Instrument average payload power contingency	15	%
Instrument average payload power <b>with</b> contingency	5.8	W
Instrument average science data rate <b>without</b> contingency	1.13	kbps
Instrument average science data rate contingency	15	%
Instrument average science data rate <b>with</b> contingency	1.30	kbps
Instrument FOVs (if appropriate)		degrees
Pointing requirements (knowledge)		degrees
Pointing requirements (control)		degrees
Pointing requirements (stability)		degrees/second
Cost	7.1	\$M FY25
Heritage instrument	MESSENGER Mag	



**Table B.17. Orbiter – Microwave Radiometer.**

Item	Value	Units
Frequency range	0.6 - 22	GHz
Channels	6 (antenna)	channels
Size/dimensions (for each instrument)	A1: 160 × 160 × 13.1 cm A2: 76.8 × 76.8 × 9.8 cm A3: 77.1 × 67.3 × 8.9 cm A4: 38.6 × 34.0 × 5.7 cm A5: 20.1 × 17.9 × 4.4 cm A6: 15.3 × 15.3 × 34 cm	cm × cm × cm
Instrument mass <b>without</b> contingency (CBE)	46.0	kg
Instrument mass contingency	15	%
Instrument mass <b>with</b> contingency (CBE+Reserve)	52.9	kg
Instrument average payload power <b>without</b> contingency	32	W
Instrument average payload power contingency	15	%
Instrument average payload power <b>with</b> contingency	36.8	W
Instrument average science data rate <b>without</b> contingency		kbps
Instrument average science data rate contingency		%
Instrument average science data rate <b>with</b> contingency		kbps
Instrument FOVs (if appropriate)	A1: 20.6 A2: 21.0 A3: 12.1 A4: 12.1 A5: 12.0 A6: 10.8	degrees
Pointing requirements (knowledge)		degrees
Pointing requirements (control)		degrees
Pointing requirements (stability)		degrees/second
Cost	56.4*	\$M FY25
Heritage instrument	Juno MWR	

\*Unmodified cost

**Table B.18. Orbiter – ToF Dust Spectrometer.**

Item	Value	Units
Mass range	1–500	amu
Mass resolution	≥200	m/Δm
Size/dimensions (for each instrument)		cm × cm × cm
Instrument mass <b>without</b> contingency (CBE)	9.35	kg
Instrument mass contingency	15	%
Instrument mass <b>with</b> contingency (CBE+Reserve)	10.75	kg
Instrument average payload power <b>without</b> contingency	13.28	W
Instrument average payload power contingency	15	%
Instrument average payload power <b>with</b> contingency	15.27	W
Instrument average science data rate <b>without</b> contingency	0.3	kbps
Instrument average science data rate contingency	15	%
Instrument average science data rate <b>with</b> contingency	0.345	kbps
Instrument FOVs (if appropriate)	±50	degrees
Pointing requirements (knowledge)		degrees
Pointing requirements (control)		degrees
Pointing requirements (stability)		degrees/second

Item	Value	Units
Cost	15.1	\$M FY25
Heritage instrument	IMAP IDEX	

**Table B.19. Orbiter – EPO Camera.**

Item	Value	Units
Spectral range	400–900	nanometers
Number of channels	1	channels
Size/dimensions (for each instrument)	7 × 5.2 × 3.6	cm × cm × cm
Instrument mass <b>without</b> contingency (CBE)	0.7	kg
Instrument mass contingency	15	%
Instrument mass <b>with</b> contingency (CBE+Reserve)	0.8	kg
Instrument average payload power <b>without</b> contingency	2	W
Instrument average payload power contingency	15	%
Instrument average payload power <b>with</b> contingency	2.3	W
Instrument average science data rate <b>without</b> contingency		kbps
Instrument average science data rate contingency	15	%
Instrument average science data rate <b>with</b> contingency		kbps
Instrument FOVs (if appropriate)	60	degrees
Pointing requirements (knowledge)		degrees
Pointing requirements (control)		degrees
Pointing requirements (stability)		degrees/second
Cost	1.9	\$M FY25
Heritage instrument	Rosetta CIVA	

## Probe Instrument Payload Description

The following table provides a brief description of the instrument suite for the probe.

**Table B.20. Probe instrument summary. Not listed: Doppler Wind Experiment because it is part of the RF system**

Instrument Type	Heritage Mission	
Mass Spectrometer	Galileo Probe	In situ measurements of neutral molecular composition as a function of altitude. Needed for ground-truth measurements of Neptune composition, including noble gases.
Helium Abundance Detector	Galileo Probe	Ingest atmospheric gas and analyze the refractivity to measure precise helium abundance; it assumes that the atmospheric gas is almost entirely hydrogen and helium, and the rest of the minor species do not contribute to the refractivity. Helium is also measured by the mass spectrometer, but because of the measurement's importance, the Helium Abundance Detector was carried for redundancy on Galileo Probe. A Helium Abundance Detector is more precise than a mass spectrometer for helium.  Helium is an inert gas that is difficult to measure any other way. Hydrogen/helium abundances are crucial to solar system and planetary formation models.
Atmospheric Structure Instrument		A package of several measurements to make a time series of “weather” type measurements as the probe descends. Accelerometer, temperature, pressure. Accelerometer needs to cover a huge range between 300 g and cm/s <sup>2</sup> , so it needs several designs to accommodate the range. Temperature and pressure sensors must be mounted on a sensor mast that sticks outside the boundary layer. Pressure sensor will measure the dynamic pressure using a Kiel-type probe, and static pressure has to be deduced analytically.

Instrument Type	Heritage Mission	
Ortho-Para H <sub>2</sub> Detector		<p>Measures the speed of the sound to derive the heat capacity, which can be used to solve for the vertical distribution of the ratio of the hydrogen molecules in the ortho- and para-states. In the ortho- and para-states, the nuclear spin of the two molecules are opposed and aligned, respectively. The ortho-para equilibrium ratio depends on the temperature; because the para-state has higher internal energy; the higher the temperature, the more molecules end up in the para-state. However, the equilibration time is slow, which means that, when there is significant vertical transport, the local ortho-para fraction will be out of equilibrium. If more para hydrogen molecules are found than the equilibrium expected from the local temperature, there must be an upwelling from a deeper, warmer region. If less para hydrogen is found, there must be a downwelling from a higher colder layer. The latent heat release during the state change also affects the atmospheric dynamics, but the latent heat effect is not as strong as cloud condensation.</p> <p><a href="#">Link</a></p>
Nephelometer		<p>A Galileo-style nephelometer has a light source that shines outward into the atmosphere outside the descent module, and two photometers measure the amount of light scattered by particulate matters suspended in the atmosphere (e.g., cloud droplets). A mirror is placed in front of the light source such that it reflects light toward one of the photometers, which will measure the forward scattering. The other photometer is placed such that it only measures the backscattering.</p> <p>Atmospheric aerosols are key determinants of the global heat balance and atmospheric circulation. They are as yet still poorly understood. There is a distinct need for nephelometers on descent probes into these planetary atmospheres.</p> <p><a href="#">Link</a></p>
Net Flux Radiometer	Galileo Probe	<p>Measures the vertical profile of the ratio between upward and downward radiation fluxes in multiple spectral bands from visible to far infrared (IR) wavelengths to measure the net flux (i.e., radiative balance). Derives radiative heating profiles and contributes to better understanding of Jovian atmospheric dynamics, to the detection of cloud layers and determination of their opacities, and to the estimation of water vapor abundance.</p> <p><a href="#">Link</a></p>
Public Engagement Camera	Rosetta CIVA	<p>As above.</p> <p>For some reason costs more on probe.</p>
Ultra-Stable Oscillator	Experiment, not an Instrument	<p>An RF oscillator that has low frequency drift/fluctuation. It is typically a crystal quartz oscillator – quartz oscillation frequency is sensitive to the temperature, so a USO ensures that the quartz temperature is stabilized to a pre-determined temperature by placing the quartz crystal next to a thermal reservoir that is electrically heated.</p>

## Probe Payload Images

[Figure B.2](#) provides a notional depiction of the probe instruments.

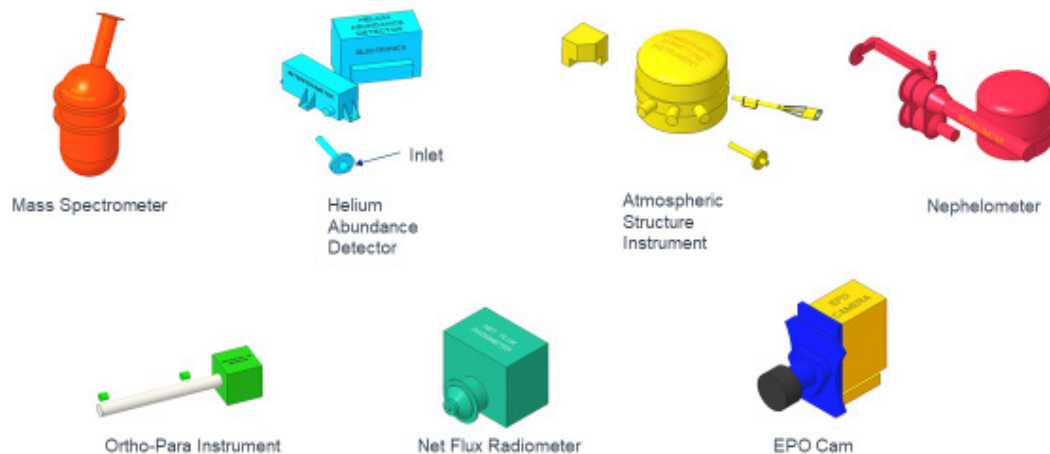

Figure B.2. Notional depiction of the probe instruments.

## Details for Each Probe Instrument

Table B.21. Probe – Mass Spectrometer.

Item	Value	Units
Type of instrument		
Number of channels		
Size/dimensions (for each instrument)	44.34 x 22.59 x 22.21	cm × cm × cm
Instrument mass <b>without</b> contingency (CBE)	13	kg
Instrument mass contingency	30	%
Instrument mass <b>with</b> contingency (CBE+Reserve)	16.9	kg
Instrument average payload power <b>without</b> contingency	25	W
Instrument average payload power contingency	15	%
Instrument average payload power <b>with</b> contingency	28.75	W
Instrument average science data rate <b>without</b> contingency		kbps
Instrument average science data rate contingency		%
Instrument average science data rate <b>with</b> contingency		kbps
Instrument FOVs (if appropriate)		degrees
Pointing requirements (knowledge)		degrees
Pointing requirements (control)		degrees
Pointing requirements (stability)		degrees/second

Table B.22. Probe – Helium Abundance Detector.

Item	Value	Units
Type of instrument		
Number of channels		
Size/dimensions (for each instrument)	12.7 x 4.445 x 5.715	cm × cm × cm
Instrument mass <b>without</b> contingency (CBE)	1.4	kg
Instrument mass contingency	30	%
Instrument mass <b>with</b> contingency (CBE+Reserve)	1.82	kg
Instrument average payload power <b>without</b> contingency	0.9	W
Instrument average payload power contingency	15	%
Instrument average payload power <b>with</b> contingency	1	W

Item	Value	Units
Instrument average science data rate <b>without</b> contingency	0.004	kbps
Instrument average science data rate contingency		%
Instrument average science data rate <b>with</b> contingency		kbps
Instrument FOVs (if appropriate)		degrees
Pointing requirements (knowledge)		degrees
Pointing requirements (control)		degrees
Pointing requirements (stability)		degrees/second

**Table B.23. Probe – Atmospheric Structure Instrument.**

Item	Value	Units
Type of instrument		
Number of channels		
Size/dimensions (for each instrument)	17.604 x 14.862 x 11.711	cm × cm × cm
Instrument mass <b>without</b> contingency (CBE)	1.4	kg
Instrument mass contingency	30	%
Instrument mass <b>with</b> contingency (CBE+Reserve)	1.82	kg
Instrument average payload power <b>without</b> contingency	5	W
Instrument average payload power contingency	15	%
Instrument average payload power <b>with</b> contingency	5.75	W
Instrument average science data rate <b>without</b> contingency	0.050	kbps
Instrument average science data rate contingency		%
Instrument average science data rate <b>with</b> contingency		kbps
Instrument FOVs (if appropriate)		degrees
Pointing requirements (knowledge)		degrees
Pointing requirements (control)		degrees
Pointing requirements (stability)		degrees/second

**Table B.24. Probe – Ortho-Para H<sub>2</sub> Detector.**

Item	Value	Units
Type of instrument		
Number of channels		
Size/dimensions (for each instrument)	32.235 x 7.235 x 7.235	cm × cm × cm
Instrument mass <b>without</b> contingency (CBE)	0.5	kg
Instrument mass contingency	30	%
Instrument mass <b>with</b> contingency (CBE+Reserve)	0.65	kg
Instrument average payload power <b>without</b> contingency	3.5	W
Instrument average payload power contingency	15	%
Instrument average payload power <b>with</b> contingency	4	W
Instrument average science data rate <b>without</b> contingency	0.050	kbps
Instrument average science data rate contingency		%
Instrument average science data rate <b>with</b> contingency		kbps
Instrument FOVs (if appropriate)		degrees
Pointing requirements (knowledge)		degrees
Pointing requirements (control)		degrees
Pointing requirements (stability)		degrees/second

**Table B.25. Probe – Nephelometer.**

Item	Value	Units
Type of instrument		
Number of channels		
Size/dimensions (for each instrument)	44.132 x 13.811 x 8.748	cm × cm × cm
Instrument mass <b>without</b> contingency (CBE)	2.3	kg
Instrument mass contingency	30	%
Instrument mass <b>with</b> contingency (CBE+Reserve)	2.99	kg
Instrument average payload power <b>without</b> contingency	4.6	W
Instrument average payload power contingency	15	%
Instrument average payload power <b>with</b> contingency	5.29	W
Instrument average science data rate <b>without</b> contingency	0.010	kbps
Instrument average science data rate contingency		%
Instrument average science data rate <b>with</b> contingency		kbps
Instrument FOVs (if appropriate)		degrees
Pointing requirements (knowledge)		degrees
Pointing requirements (control)		degrees
Pointing requirements (stability)		degrees/second

**Table B.26. Probe – Net Flux Radiometer.**

Item	Value	Units
Type of instrument		
Number of channels		
Size/dimensions (for each instrument)	17.028 x 15.24 x 13.37	cm × cm × cm
Instrument mass <b>without</b> contingency (CBE)	3.13	kg
Instrument mass contingency	30	%
Instrument mass <b>with</b> contingency (CBE+Reserve)	4.07	kg
Instrument average payload power <b>without</b> contingency	4	W
Instrument average payload power contingency	15	%
Instrument average payload power <b>with</b> contingency	4.6	W
Instrument average science data rate <b>without</b> contingency	0.050	kbps
Instrument average science data rate contingency		%
Instrument average science data rate <b>with</b> contingency		kbps
Instrument FOVs (if appropriate)		degrees
Pointing requirements (knowledge)		degrees
Pointing requirements (control)		degrees
Pointing requirements (stability)		degrees/second

**Table B.27. Probe – Public Engagement Camera.**

Item	Value	Units
Type of instrument		
Number of channels		
Size/dimensions (for each instrument)	0.07 × 0.052 × 0.036	m × m × m
Instrument mass <b>without</b> contingency (CBE)	0.6	kg
Instrument mass contingency	30	%
Instrument mass <b>with</b> contingency (CBE+Reserve)	0.78	kg
Instrument average payload power <b>without</b> contingency	2	W



Item	Value	Units
Instrument average payload power contingency	0.15	%
Instrument average payload power <b>with</b> contingency	2.3	W
Instrument average science data rate <b>without</b> contingency	4	kbps
Instrument average science data rate contingency		%
Instrument average science data rate <b>with</b> contingency		kbps
Instrument FOVs (if appropriate)		degrees
Pointing requirements (knowledge)		degrees
Pointing requirements (control)		degrees
Pointing requirements (stability)		degrees/second

**Table B.28. Doppler Wind Experiment.**

Item	Value	Units
Type of instrument		
Number of channels		
Size/dimensions (for each instrument)		m × m × m
Instrument mass <b>without</b> contingency (CBE*)	2.4	kg
Instrument mass contingency	30	%
Instrument mass <b>with</b> contingency (CBE+Reserve)	3.12	kg
Instrument average payload power <b>without</b> contingency	8.5	W
Instrument average payload power contingency	0.15	%
Instrument average payload power <b>with</b> contingency	3	W
Instrument average science data rate <sup>A</sup> <b>without</b> contingency		kbps
Instrument average science data <sup>A</sup> rate contingency		%
Instrument average science data <sup>A</sup> rate <b>with</b> contingency		kbps
Instrument FOVs (if appropriate)		degrees
Pointing requirements (knowledge)		degrees
Pointing requirements (control)		degrees
Pointing requirements (stability)		degrees/second

## Science Data Rates and Volume

**Table B.29. Data volume summary per instrument.**

Instrument	Heritage Estimation Basis	Data Rate (Survey)	Data Rate (Hi-res)	Data Rate (burst)	Data Volume, bits	Low-End Compression	High-End Compression	Logic on How Data Volume Was Estimated for 20-Orbit Prime Mission
UV Imaging Spectrograph	Alice, New Horizons				<b>3.80E+11</b>	1.90E+11	3.80E+10	11 Gbit for 6-h Pluto flyby, 1.5× to use Neptune shine illumination on Triton. 20 planetary flybys (Triton or Neptune)  Equivalent of 3 flybys for Ring/small sats
Color Narrow Angle Camera	LORRI, New Horizons							
Vis-NIR Imaging Spectrometer	Ralph, New Horizons							
Thermal IR Imager	Diviner, Lunar Reconnaissance Orbiter				<b>1.53E+07</b>	7.67E+06	1.53E+06	Diviner is 21×21 pixels, 9 channels, assume 12 bits per channel, 20+3 flybys, 14 images per flyby (either of Neptune or Triton + 3 of rings/small satellites)

Instrument	Heritage Estimation Basis	Data Rate (Survey)	Data Rate (Hi-res)	Data Rate (burst)	Data Volume, bits	Low-End Compression	High-End Compression	Logic on How Data Volume Was Estimated for 20-Orbit Prime Mission
Ion and Neutral Mass Spectrometer	INMS, Cassini	400	1500	0	<b>3.08E+10</b>	1.54E+10	3.08E+09	90% of orbit in low-resolution "survey" mode, 10% in high-resolution mode
Laser Altimeter	Laser Altimeter, MESSENGER				<b>2.00E+07</b>	?	?	2 Mbit per 12-h Mercury orbit Take data on 10 of the 46 Triton flybys
Thermal Plasma Spectrometer - Ions	JADE-I, Juno	576	6144	0	<b>6.85E+10</b>	1.37E+10	?	90% of orbit in low-resolution "survey" mode, 10% in high-resolution mode
Thermal Plasma Spectrometer - electrons	JADE-I, Juno	128	1024	0	<b>1.32E+10</b>	2.63E+09	?	90% of orbit in low-resolution "survey" mode, 10% in high-resolution mode
Energetic Charged Particle Detector	EPI-Lo, Parker Solar Probe	3100	12000	0	<b>2.41E+11</b>	8.04E+10	?	90% of orbit in low-resolution "survey" mode, 10% in high-resolution mode
Energetic Neutral Atom Imager	EPI-Lo, Parker Solar Probe	4000	4000	0	<b>2.42E+11</b>	?	?	90% of orbit in low-resolution "survey" mode, 10% in high-resolution mode
Radio and Plasma Wave Detector	Wave, Juno	200	2000	100000	<b>5.32E+10</b>	1.33E+10	5.32E+09	90% of orbit in low-resolution "survey" mode, 10% in high-resolution mode, 0.5% in burst-mode
Magnetometer	Magnetometer, MESSENGER	390	1600	0	<b>3.09E+10</b>	?	?	90% of orbit in low-resolution "survey" mode, 10% in high-resolution mode, 0.5% in burst-mode
Microwave Radiometer	MWR, Juno				<b>6.91E+07</b>	?	?	Just at Neptune c/a, 4 orbits, per 1mke email, 800 bps, on for 6 h at a time
Public Engagement Camera	CIVA, Rosetta/Philae				<b>4.19E+08</b>	2.10E+08	2.10E+07	8-bit depth 1024×1024 RGG Bayer color pattern, 5 images every other orbit, mostly near Neptune or Triton closest approach. Highest data compression could be ~20
Dust Detector	IDEX, IMAP	228	0	0	<b>1.24E+10</b>	?	?	100% of orbit in low-res "survey" mode
Gravity science	N/A				-	-	-	Data collected on ground
<b>Total data for mission</b>					<b>1.07E+12</b>	<b>6.01E+11</b>	<b>4.28E+11</b>	
<b>Average per orbit</b>					<b>5.36E+10</b>	<b>3.01E+10</b>	<b>2.14E+10</b>	

# Orbiter Flight System

Table B.30 provides an overall summary of the flight system characteristics.

**Table B.30. Summary of flight system characteristics.**

Flight System Element Parameters	Value/Description
Design life, years, cruise	16
Design life, years, Neptune-Triton	4
Structure material	Aluminum
Number of articulated structures	1: pivot platform for Alice, Ralph, LORRI
Number of deployed structures	2: probe, magnetometer boom
Type of thermal control used	Mostly passive thermal control with heaters, constant conductance heat pipes and louvers utilized to protect the minimum temperature of the system
Systems	Regulated dual-mode (NTO-hydrazine/hydrazine) system
Chemical propulsion $\Delta$ -V	2268 m/s
Chemical propulsion Isp	326 s (dual-mode HiPAT thrusters)
Chemical propulsion thrusters and tanks	gHe pressurant tank, custom PMD hydrazine tank, custom PMD oxidizer tank, 2 100-lbf HiPAT thrusters, 16 1-lbf thrusters (ACS)
Control method	Three-axis
Control reference	Solar (safe), stars (all other modes)
Pointing control capability, degrees	0.029° (based on camera with tightest requirements)
Pointing knowledge capability, degrees	0.011° (based on camera with tightest requirements)
Agility requirements (pivot platform)	Slew rate: 9°/s, knowledge <0.003°
Articulation	Pivot platform with brushless motor accommodates LORRI, Alice, Ralph
Sensor and actuator information (precision/errors, torque, momentum storage, etc.)	2 fine Sun sensors, 3 star trackers with <10-arcsecond accuracy, single SSIRU, 4 RWAs with 50 Nms and 0.06 Nm capability
Flight element housekeeping rate	≤20 kbps
Data storage capacity	256 Gb
Maximum storage record rate	>2 Mbps
Maximum storage playback rate	>2 Mbps
Power source	3 NGRTGs
Beginning-of-life and end-of-life load power capability	1087 W (at launch); 727 W (21 years, postlaunch)

## Spacecraft - Volume

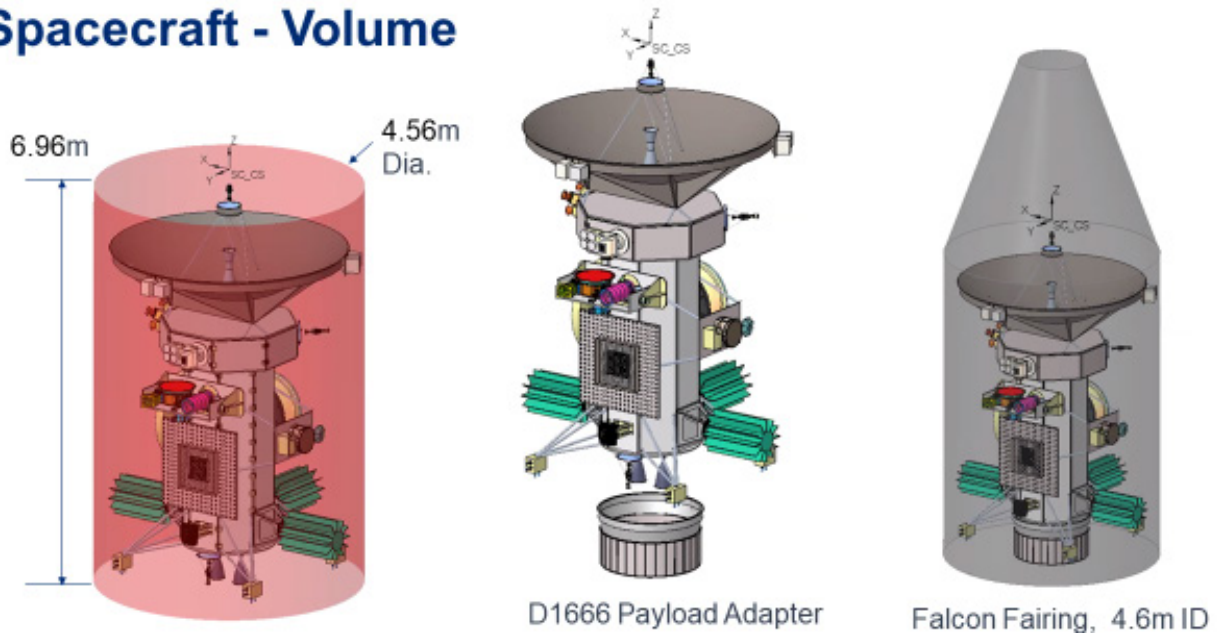

**Figure B.3. Spacecraft size and fit into Falcon fairing. Spacecraft easily fits into SLS Block 2 fairing.**

# Neptune Odyssey Flight Segment Block Diagram

6/11/2020

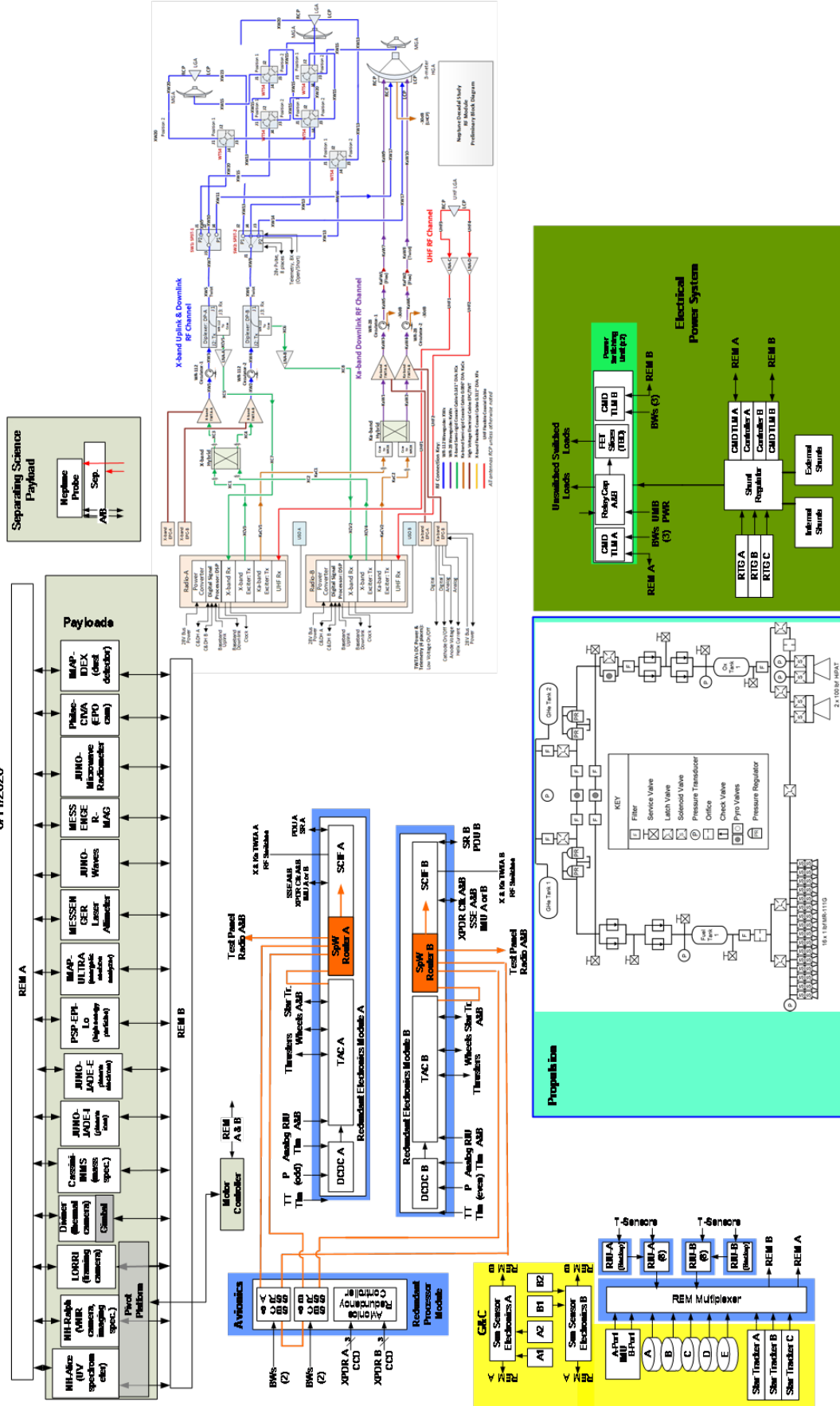

Figure B.4. Flight system block diagram.

## Guidance, Navigation, and Control (GNC)

The Neptune Odyssey GNC provides a three-axis controlled platform that satisfies all requirements set by science, navigation, communication, and propulsion. All GNC components are available commercial off-the-shelf (COTS) with multiple potential vendors.

To meet the attitude knowledge requirements, three Leonardo AA-STR star trackers are used for accuracy ( $<53\text{-}\mu\text{rad}$  boresight inertial knowledge per tracker) and redundancy. The AA-STR is currently flying on Parker Solar Probe and is the newer generation of the A-STR used on MESSENGER, STEREO, and New Horizons. The star trackers have orthogonal fields of view (FOVs) to minimize concurrent disruption by the Sun, Neptune, or other celestial bodies. The internally redundant, Northrop Grumman Scalable-SIRU, as flown on MESSENGER and Parker Solar Probe, contains redundant, cross-strapped gyroscopes and accelerometers; provides spacecraft rotational rates; and is used to propagate the spacecraft attitude solution and provide translational acceleration information for trajectory-correction maneuvers (TCMs). The S-SIRU data can also be used to propagate attitude for a limited time if the star tracker is temporarily unavailable (e.g., during TCMs or high slew rates). The Adcole digital solar aspect detectors (DSADs) are used in safe mode, where Sun-relative pointing and communications with Earth are required. The redundant system includes two electronics boxes and two heads, each with a  $64^\circ \times 64^\circ$  FOV. The DSADs are similar to those used on MESSENGER, New Horizons, and others and utilize gain-switching to provide for the large dynamic range of the mission.

Primary three-axis attitude control actuation is provided by four COTS Rockwell-Collins RSI 68-75/60 reaction wheels, similar to those used on STEREO and MESSENGER (but with larger inertia rings), each capable of providing up to 68 Nms of angular momentum storage capacity and 75 mNm of output torque. The reaction wheels are arranged for redundant torque and momentum storage capability in all three axes. Reaction wheel sizing will be further traded in the future, but the possibilities are constrained by the system mass and power constraints. The GNC also controls firing of the thrusters described in the [Propulsion](#) section when TCMs are required or for dumping of angular momentum that accumulates because of external torques on the spacecraft.

During Neptune orbital operations, the GNC will keep the bus nominally nadir-pointed toward the target body (either Neptune or one of its moons) and control off-pointing via the instrument platform gimbal. The body-fixed high-gain antenna (HGA) will be pointed at Earth for science downlink. Because of the overall spacecraft size, the spacecraft agility using the reaction wheels will be very limited, so large slews will be accomplished via firing of the thrusters. The reaction wheels will be used for fine pointing control and to minimize jitter for the most sensitive measurements.

## Propulsion

The baselined propulsion system for the spacecraft is a dual-mode, pressure-regulated system that provides  $\Delta\text{-V}$  capability and attitude control for the spacecraft. The system consists of two main bipropellant ( $\text{N}_2\text{H}_4/\text{NTO}$ ) apogee engines in the 445–645 N class (100–150 lbf), sixteen 4.4-N (1.0 lbf) monopropellant ( $\text{N}_2\text{H}_4$ ) attitude control system (ACS) thrusters, and components required to control the flow of propellants and monitor system health and performance. The propulsion system will be purchased as a complete system from a proven supplier who will integrate it onto an Johns Hopkins Applied Physics Laboratory (APL)-furnished spacecraft structure.



For the purposes of this study, performance data for the Aerojet Rocketdyne HiPAT Dual-Mode 445-N engine, Aerojet Rocketdyne MR-106E 22-N thrusters, and Aerojet Rocketdyne MR-111C/G 4.4-N thrusters were used, but alternative options exist, such as Nammo's Leros-1B and Moog-Isp's MONARC-5 engines. The MR-111C/G has heritage on multiple APL spacecraft, including MESSENGER, New Horizons, and Parker Solar Probe. The HiPAT engine is flight-qualified but unflown and may require a delta qualification program to verify the engine meets the mission's requirements.

The hydrazine is stored in a single 1252-liter titanium tank. The oxidizer is stored in a separate 604-liter titanium tank. Both tanks require custom propellant management devices (PMDs) to ensure positioning of gas-free propellant for all maneuvers at the tank outlets. The maximum expected operating pressure (MEOP) for the mission is 250 psi. Helium pressurant will be stored at a MEOP of 4500 psi in a custom composite-overwrapped titanium pressure vessel. A set of pressure regulators are used to ensure appropriate pressures in the propellant tanks and downstream lines. In addition, the design uses separate routings of check valves, latch valves, and series-redundant pressure regulators to limit fuel and oxidizer migration to the shared pressurant tank. A similar isolation design was used by MESSENGER.

The remaining components used to monitor and control the flow of propellant and pressurant—latch valves, filters, orifices, check valves, pyro valves, pressure regulators, service valves, and pressure and temperature transducers—will be selected in Phase A from a large catalog of components with substantial flight heritage on APL and other spacecraft. A Phase A trade study will consider alternative pressure regulation schemes, including the bang-bang design favored by the Jet Propulsion Laboratory (JPL).

The propulsion system supplier will be put on contract 30 months before the start of spacecraft integration and testing (I&T) to ensure optimum communication between the propulsion team and the spacecraft mechanical design team. This schedule is also required to allow sufficient time for design and fabrication of PMDs for the selected tank. The primary spacecraft structure and the tank will ship to the propulsion system supplier 6 months before the start of I&T, typical of integrated structure/propulsion systems.

## **Orbiter Avionics**

The Neptune orbiter avionics architecture is designed for block redundancy with interface cross-strapping. The avionics hardware is separated into three primary housings: the integrated electronics module (IEM), the remote interface units (RIUs), and the propulsion diode boxes (PDBs). This approach is consistent with previous APL spacecraft programs. It will take advantage of extensive use of heritage hardware from Parker Solar Probe and Europa Clipper.

Command and data handling (C&DH), GNC, and spacecraft fault protection functions will be performed in a single radiation-hardened, quad-core, GR740 processor. A cold redundant processor and solid-state recorder (SSR) will serve as backup. The redundant processor can be placed in a warm-spare state as needed. The avionics mode controller will continually monitor the status and health of the single-board computer (SBC) and SSR systems and switch or change power states of the equipment if necessary.

The SSR will form sixteen 8-Gbit memory banks by stacking four 2-Gbit flash memories. This design leverages existing technologies developed for the Parker Solar Probe mission. Tests will be

conducted to verify proper operation of the 2-Gbit memories at a total dose limit of 100 krad, while operating at a 10% duty cycle.

The IEM also consists of the Spacecraft Interface Cards (SCIF), the Thruster/Actuator Controllers (TAC), and the Multiplexer Card. The IEM incorporates cross-strapped redundancy for payload and navigation interfacing, and SpaceWire links to the SBCs through a 9-port SpaceWire router. The SpaceWire and payload routing will be performed by an RTG4 field-programmable gate array (FPGA) onboard the SCIF.

The RIUs are configured to measure resistive temperature detectors located on spacecraft components. Each RIU reports a binary count that corresponds to a measured resistance. Test software or flight software then interprets the raw binary values as resistances using linear coefficients obtained during calibration of each RIU. Finally, these calculated resistances are converted to temperature measurements using data provided by the manufacturer of the sensor in question.

The PDBs interface between the A/B side of the IEM and the propulsion subsystem. The two units provide inductive kickback protection from high inductance loads, such as rocket engines.

## **Probe Avionics**

The Neptune probe avionics architecture is designed for block redundancy. The avionics hardware consists of SBCs and MiSCs. This will take advantage of extensive use of heritage hardware from Parker Solar Probe and DART. C&DH, GNC, and spacecraft fault protection functions will be performed in a single radiation-hardened, quad-core, GR740 processor, same as the orbiter.

The MiSCs will provide probe components and instruments interfaces as well as monitoring of temperature sensors. Because the probe will separate from the orbiter 30 days before entering Neptune atmosphere, a low-power and highly optimized timer circuit for power sequence is needed. This timer will work from a 5-V battery and consume no more than 250 mW, and it will be incorporated as part of the MiSC card design.

The probe avionics incorporates redundancy for payload and navigation interfacing, and SpaceWire links between the probe SBCs and MiSCs as well as orbiter SBCs and probe SBCs SpaceWire router. The SpaceWire and payload routing will be performed by an RTG4 FPGA onboard the MiSC.

## **Probe Electrical Power System**

The Electrical Power Subsystem (EPS) provides power distribution and energy storage for the probe. Block redundant power distribution is implemented using the same switch slices used in the power-switching units (PSUs). For the probe, these cards are not separate units but instead are included in consolidated probe electronics modules. Two lithium thionyl chloride primary batteries, selected for high energy density and long storage life, provide power to the probe. The first provides power only to a timer circuit activated when the probe is separated from the orbiter. The second provides power to the probe during descent operations. Before deployment, the probe electronics can be checked by supplying power from the orbiter. The primary batteries remain isolated during these periods.

Timer circuit power is provided by 10 parallel connected SAFT LS 33600 cells operating at ~3.4 V. Probe power is provided by 48 SAFT LSH20 cells connected in six parallel strings of eight series cells, operating at ~26 V. Both batteries have been sized to provide the required power with 30% margin, within cell rate limits, and including capacity degradation of 2% per year. Additional work

is required to demonstrate that the cells can meet the long storage life required. A NASA-funded study, *Energy Storage Technologies for Future Planetary Science Missions* (December 2017), cites the need for long-life (>15 year) primary battery development for atmospheric probe missions.

Thermal batteries, secondary lithium-ion batteries, and other lithium primary chemistries with flight history were considered as part of this study. Thermal batteries have been qualified for 30 years of storage life but are designed for hours, rather than days, of operation after activation. Secondary cells provide lower energy density than primary cells and would require charge and balance electronics for maintenance through the long cruise. Therefore, lithium primary cells with flight heritage for longer performance were selected.

## Power Modes

**Table B.31. Flight system power modes.**

Subsystem/Instrument	Science	$\Delta$ -V Prep	$\Delta$ -V	Radio Science	Data Link
Payload Instruments	179	79	65	65	95
Command and Data Handling (C&DH)	33	28	28	28	28
Guidance, Navigation, and Control (GNC)	92	92	38	62	62
Electrical Power System (EPS)	36	36	36	36	36
Thermal	20	20	80	20	20
Telemetry, Tracking, and Control (TT&C)	14	14	14	224	184
Propulsion	15	115	161	15	15
TOTAL	388	384	421	449	440
System Contingency	43%	43%	43%	43%	43%
Spacecraft with Contingency and Harness Loss	561	555	609	648	635
Total RTG Years	23	23	23	23	23
Available Power	727	727	727	727	727
Unallocated Margin, W	166	172	118	78	91
Unallocated Margin, %	23%	24%	16%	11%	13%

## Flight Software

The Neptune Odyssey flight software (FSW) is built upon software successfully flown on multiple APL missions, including the most recent Parker Solar Probe. The FSW uses a layered architecture to encapsulate functionality into multiple distinct applications. This ensures that functionality is self-contained and readily maintainable.

## Probe Flight System

The Neptune Odyssey probe has a mass of 273.2 kg, including 30% contingency. More than half the mass is dedicated to the thermal protection system (TPS)/entry and descent systems. Within the TPS aeroshell, the descent module houses and manages all science instruments and electronics, except for Engineering Science Investigation (ESI) instrumentation sensors embedded within the TPS itself. The orbiter separation mechanism provides spin stabilization of the probe during the approach and entry to the Neptune atmosphere.

The descent module itself is a truncated sphere for atmospheric stability and provides sufficient clearance margin to the interior of the TPS and the mortar-fired descent parachute attached to the backshell. Provisions for anti-spin vanes are included as the design matures. Both the descent

module and heat shield have a load path through the backshell. Two sets of three separation mechanisms provide for separation of the heat shield from the backshell and for the descent module from the backshell. Interior temperature of the descent module is maintained during the 30-day approach using radioisotope heater units (RHUs) to alleviate battery capacity that would otherwise be needed for thermal control. Thermal switches to a radiator on the descent module shell provide for thermal management during cruise, approach, and descent.

During cruise to the Neptune system, the probe flight computer and individual components may be checked and updated using bus power provided by the orbiter; however, the majority of probe electronics are unpowered during cruise and Neptune approach except as needed for opportunistic cruise science. A redundant low-power timer circuit, triggered by orbiter separation, is powered during the 30-day final approach and governs the sequencing of bus power-up based on the expected time of atmospheric entry. Instruments requiring warm-up are powered before entry, such as the USO supporting Doppler wind measurements. Instruments requiring calibration measurements before exposure to the atmosphere are powered before heat shield separation. Accelerometer and ESI data are recorded during the entry and high-g-load deceleration of the probe. Once the descent module separates from the aeroshell, the instruments begin recording science data to be relayed to the orbiter for eventual return to Earth after Neptune orbit insertion (NOI).

The probe avionics consist of block redundant electronics strings in separately housed IEMs, each including an SBC, instrument data interface, separation timer circuit, power conversion and switching, and RF transmitter based on APL's reliable, small-form-factor CoreSat architecture. Two independent ultrahigh frequency (UHF) solid-state power amplifier (SSPA) transmit channels (10 W RF) are powered simultaneously for one-way data relay to the orbiter during descent. The probe uses two simple monopole antennas, with possible alternatives including conformal, patch, turnstile, and microstrip designs to optimize the radiation pattern for the final orbiter-probe geometry and enhance data return.

## Decadal Neptune Odyssey Probe Block Diagram

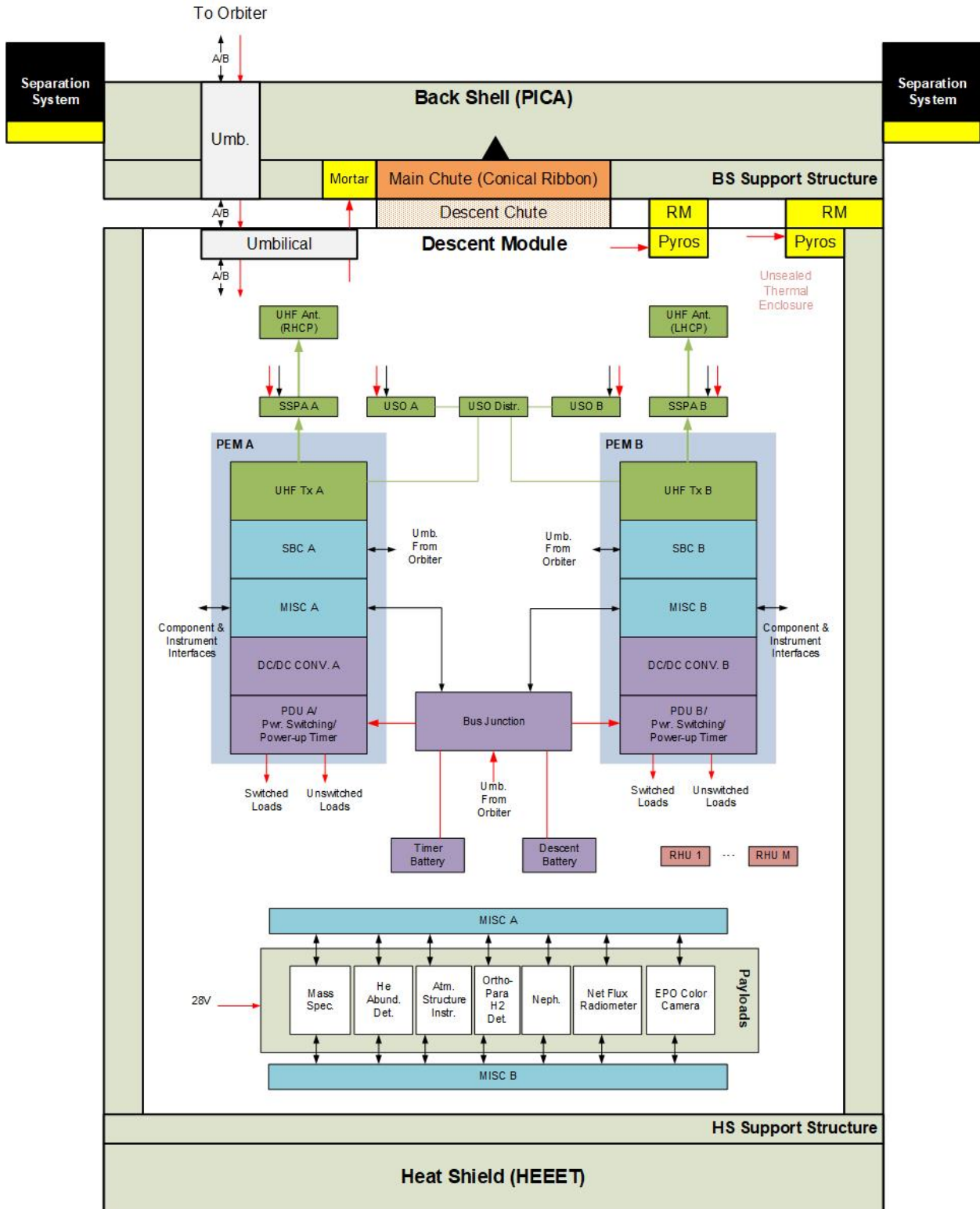

**Figure B.5. Atmospheric probe block diagram.**

**Table B.32. Probe mass summary.**

Neptune Odyssey Probe Mass Summary			
Subsystem	CBE	Cont.	MEV
<b>Entry &amp; Descent System</b>	<b>108.0</b>	<b>30%</b>	<b>140.3</b>
Heatshield (incl. ESI)	75.8	30%	98.5
Backshell (including parachutes)	32.2	30%	41.8
<b>Descent Module Total</b>	<b>102.8</b>	<b>29%</b>	<b>132.9</b>
CDH (Avionics)	2.4	15%	2.8
EPS	15.3	39%	21.1
Harness	3.1	30%	4.0
Thermal	4.6	18%	5.5
RF Communications	4.7	17%	5.6
Mechanical	48.0	29%	61.8
Payload (Instruments)	24.7	30%	32.2
<b>Flight System Entry Mass (at Neptune interface)</b>	<b>210.8</b>	<b>30%</b>	<b>273.2</b>
<b>Orbiter Separation System</b>	<b>22.0</b>	<b>30%</b>	<b>28.6</b>
<b>TOTAL PROBE "PAYLOAD" MASS TO ORBITER</b>	<b>232.8</b>	<b>30%</b>	<b>301.8</b>

Neptune Odyssey Probe Power Loads - Entry & Descent			
Subsystem	CBE	Cont.	MEV
CDH (Avionics)	20.0	15%	23.0
EPS	9.0	0%	9.0
RF Communications	61.9	9%	67.6
Payload (Instruments)	45.0	15%	51.8
Mass Spectrometer	25.0	15%	28.8
Helium Abundance Detector	0.9	15%	1.0
Atmospheric Structure Instrument	5.0	16%	5.8
Ortho-Para Hydrogen Detector	3.5	14%	4.0
Nephelometer	4.6	15%	5.3
Net Flux Radiometer	4.0	15%	4.6
EPO Camera	2.0	15%	2.3
ESI (Engineering Science Investigation)	8.5	15%	9.8
Thermal	RHUs		
Mechanisms	Pulsed		
<b>Total Steady State Load (Watts)</b>	<b>144.4</b>	<b>12%</b>	<b>161.2</b>

## Thermal Protection System

The 3D-woven, dual-layer HEEET TPS was recently developed to TRL 6 for outer-planet (and Venus) missions, and sizing was conducted according to best practices. The Odyssey configuration of the HEEET TPS has recession and insulation layer thicknesses that are similar to HEEET development, which included a 1-m engineering test unit (ETU). However, the peak stagnation pressure of 6.2 atm (and 1560 W/cm<sup>2</sup> nominal heat flux) predicted for Odyssey entry is higher than

key HEEET arc jet testing at 5.4 atm (and 3600 W/cm<sup>2</sup>). Some additional high-pressure testing, or additional analysis and margin, will be needed to achieve TRL 6 for the Odyssey mission. It is noteworthy that no failure was observed in arc jet testing HEEET at 14 atm and 1000 W/cm<sup>2</sup>.

CFD simulations predict a nominal peak heat flux of 5470 W/cm<sup>2</sup> (at 1.7 atm) on the shoulder of the probe forebody. Although this is within the expected performance regime for HEEET, the highest convective heat flux testing performed to date was at 3600 W/cm<sup>2</sup>. While radiative (laser) exposure of HEEET up to 8000 W/cm<sup>2</sup> demonstrated good capability at this heating rate, it will be necessary to design and perform additional arc jet testing to qualify HEEET at the higher heat flux, or apply additional analysis and margin, to achieve TRL 6 for the Odyssey probe. Given the long manufacturing lead times for HEEET, a minimum of 2 years would be required to procure, manufacture, and perform the required testing. The HEEET thickness sizing resulted in 1.48-cm recession layer thickness and 1.0-cm insulation layer thickness, with a total mass of 43.3 kg.

For the backshell TPS, the Phenolic Impregnated Carbon Ablator (PICA) was conservatively sized, assuming a peak heat flux of 400 W/cm<sup>2</sup> and pressure of 0.64 atm. Sizing resulted in a PICA thickness of 1.9 cm and a mass of 7.9 kg. Although PICA has significant flight heritage, a key constituent of the TPS has recently changed, and it is currently in the latter stages of requalification at TRL 6 for missions such as Odyssey. It is assumed that because the requalification is in progress, no technology development will be needed.

**Table B.33. Entry parameters, environments, and Heatshield for Extreme Entry Environment Technology (HEEET) sizing.**

Parameters	Value	Unit
Velocity (inertial)	23.94	km/s
Velocity (planet-relative)	26.26	km/s
Entry flight path angle	-17.8	degrees
Azimuth (inertial)	27.13	degrees
Entry interface altitude	1085	km
Radial distance	25,744	km
Latitude	29.53	degrees
Longitude	163.6	degrees
Max deceleration	156	Earth g's
Max stagnation pressure	6.2	bar
Peak stagnation heat flux	3560	W/cm <sup>2</sup>
Peak heat flux (on flank)	5470	W/cm <sup>2</sup>
Total heat load	92,700	J/cm <sup>2</sup>
HEEET recession layer	1.48	cm
HEEET insulation layer	1.00	cm



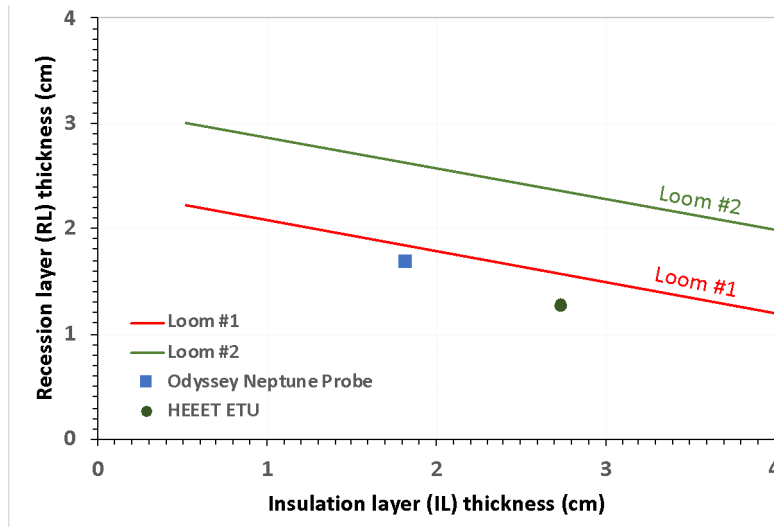

Figure B.6. Odyssey HEET TPS thickness shown with loom weaving capabilities.

There is a need for sustaining the thermal protection systems that would be critical to the Neptune Odyssey probe. Additionally, to support some of the environmental conditions that could be encountered during probe EDL, technology development may be needed to improve manufacturing processing of thermal protection materials. Jay Feldman has drafted a paper describing the need for sustaining and improvements needed for TPSs. The paper is titled: *Sustaining Mature Thermal Protection Systems Crucial for Future In-Situ Planetary Missions*.

## RF Communications

### Spacecraft RF Communications Subsystem (Orbiter)

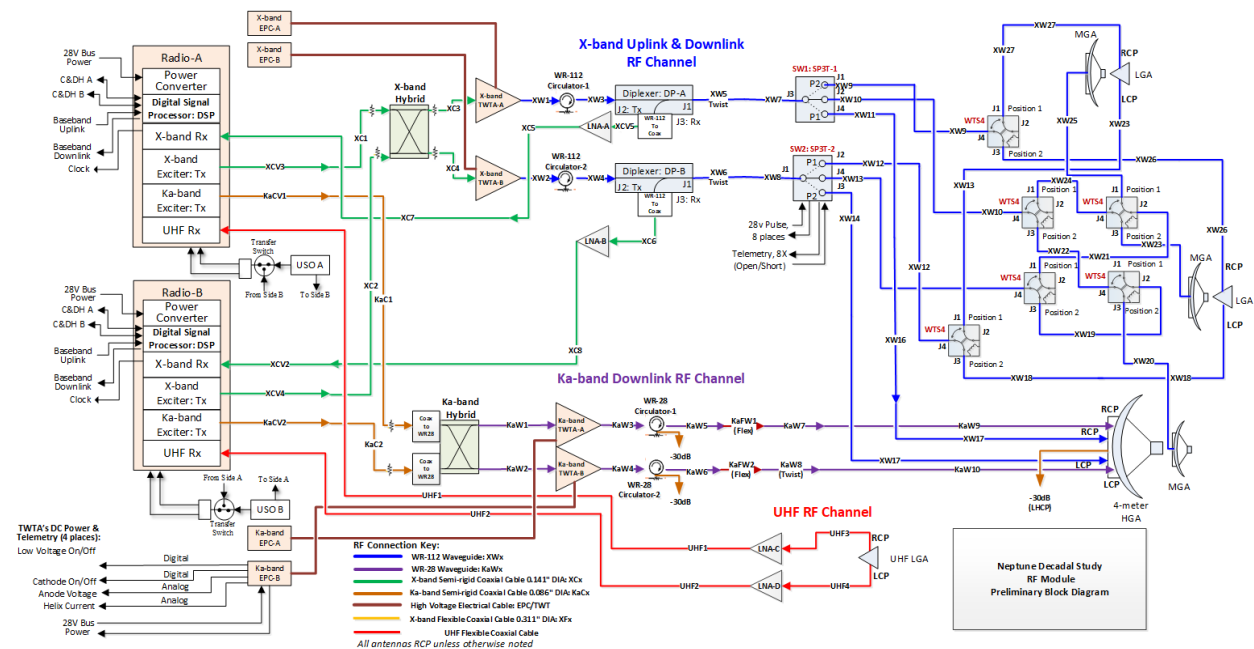
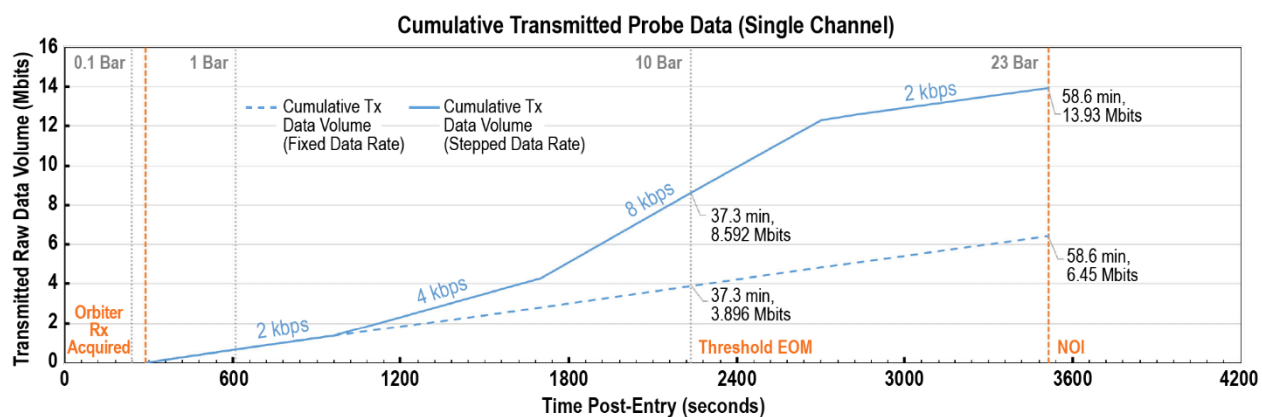

Figure B.7. Telecommunications subsystem block diagram (orbiter).

The orbiter carries a dedicated medium-gain antenna for relay communications with the probe. The orbiter records data soft-symbols and samples carrier frequency and amplitude at high rate during probe descent in support of radio science. Precision stable frequency reference is provided by redundant USOs on both the probe and the orbiter. The orbiter will track the probe with its relay antenna to  $>5^\circ$  using its propulsion system. Although not implemented on this point design, an articulated antenna could facilitate both the NOI burn and probe descent telemetry simultaneously.

The two transmitters will utilize offset frequencies, differential delay in the transmitted data, and potentially opposite polarizations, depending on final choice of antenna design. The two channels provide not only frequency diversity for the Doppler wind radio science but also robustness to scintillation fades and graceful degradation to component failures. Relay data rate is increased by schedule as the orbiter-to-probe geometry improves during descent. Science data may be prioritized for transmission on both channels, or selectively on one, allowing for a balance between redundancy and enhanced science return. A summary of the raw data return achievable with a single relay channel is shown below in [Figure B.8](#).



**Figure B.8. Cumulative transmitted probe data for a single channel as a function of time after atmospheric entry.**

Two lithium thionyl chloride primary batteries, selected for high energy density and long storage life, provide power to the probe. The first ( $10 \times$  SAFT LS 33600 cells at 3.4 V) provides power to the low-power timer circuit activated when the probe is separated from the orbiter. The second ( $48 \times$  SAFT LSH20 cells, 6p8s at 26 V) provides power to the probe during descent operations and is sized for an average probe power draw of 144 W (CBE) supporting all instruments, redundant avionics modules, and parallel RF links concurrently. The primary batteries remain isolated during all other periods during cruise. Both batteries have been sized to provide the required power with 30% margin, within cell rate limits, and including capacity degradation of 2% per year. Additional work is required to demonstrate that the cells can meet the long storage life required. The NASA-funded study, *Energy Storage Technologies for Future Planetary Science Missions* (December 2017), cites the need for long-life ( $>15$  year) primary battery development and qualification for atmospheric probe missions, particularly of the outer ice giant planets.

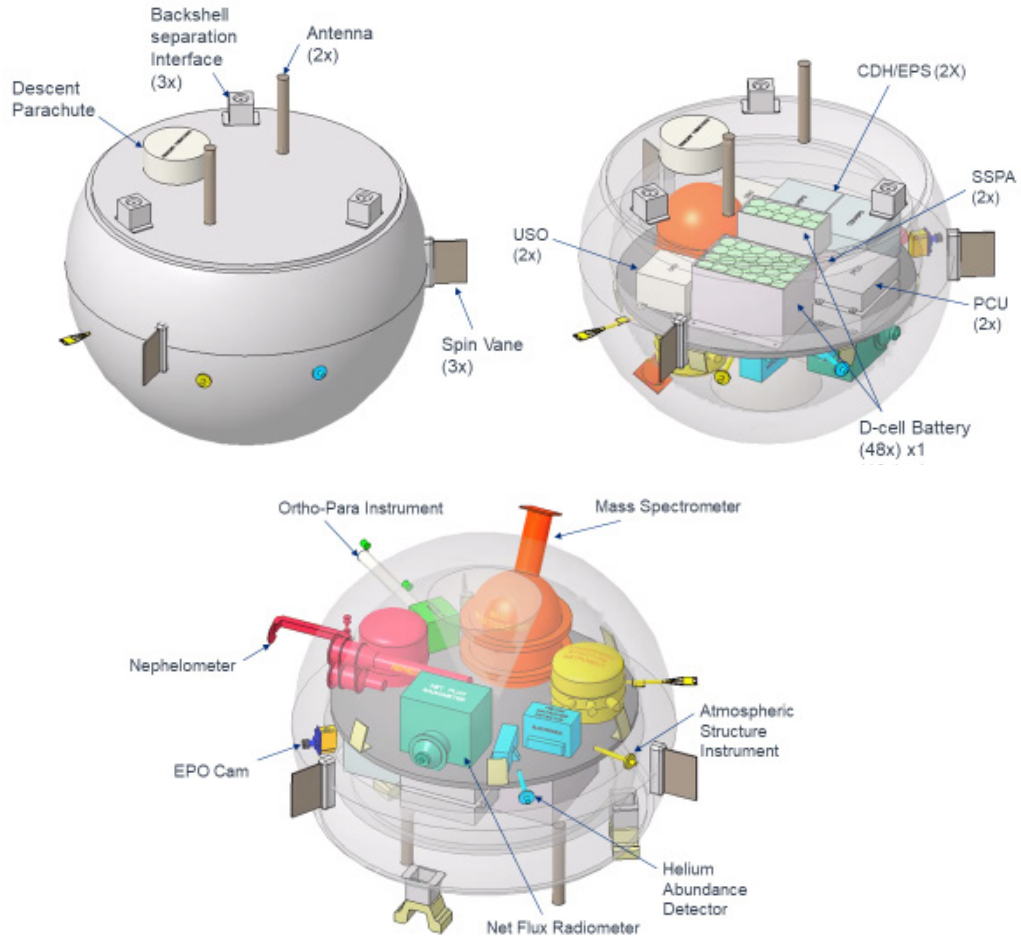

**Figure B.9. Descent module.**

# Probe Entry, Descent, and Landing (EDL)



National Aeronautics and Space Administration

**Neptune Odyssey**  
*Trajectory and Parachute System Discussion*

Soumyo Dutta  
NASA Langley Research Center  
June 9, 2020

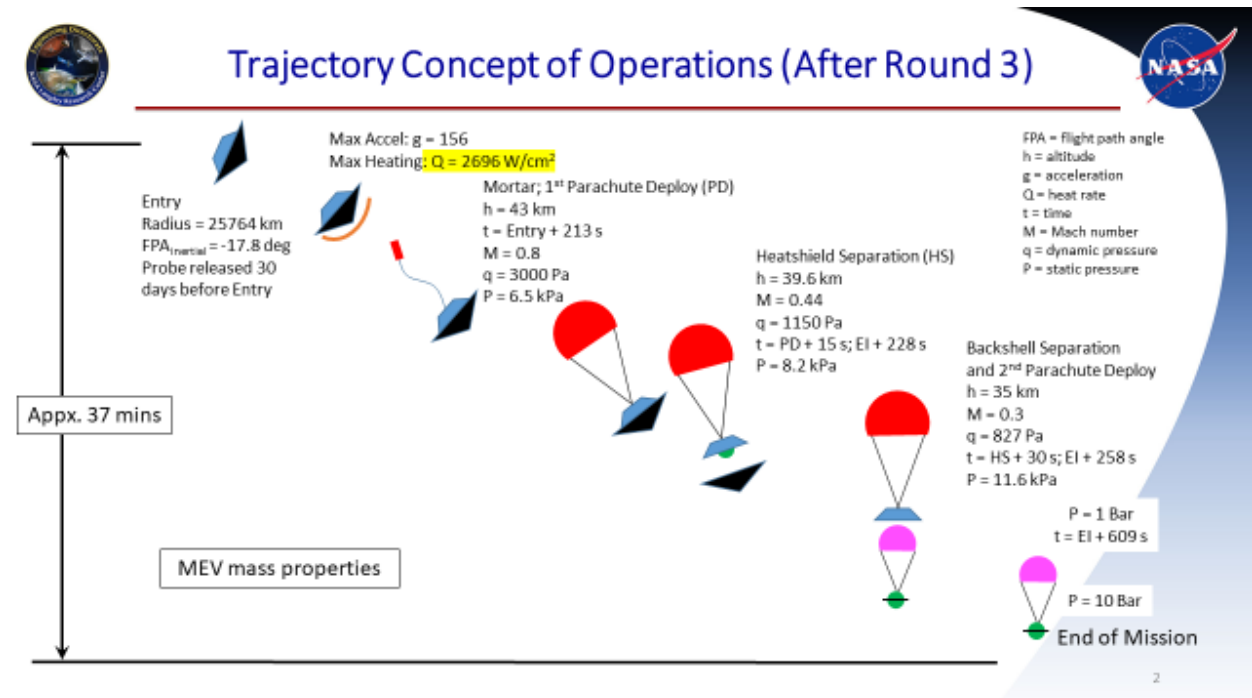

# Assumptions



## 3 Degree-of-Freedom Trajectory Analysis

### Entry Vehicle

- 45 deg. half-angle sphere-cone; heritage from Pioneer Venus and Galileo (Jupiter)
- Entry Body Diameter: 1.26 m
- Nose Radius: 0.4 m
- Ballistic Coefficient: Approximately 220 kg/m<sup>2</sup>

### Parachutes

- 1<sup>st</sup> parachute: Conical Ribbon, Diameter: 2.5 m
  - Deploy at Mach 0.8
  - Mortar deployed
  - Used for separation system – separate heatshield and then probe from backshell
  - Conical Ribbon Parachute – heritage from Pioneer Venus and Galileo (Jupiter)
- 2<sup>nd</sup> parachute: Ringsail, Diameter: 1.5 m
  - Deploy at Mach 0.2
  - Increases descent time by 10 mins
  - Inflates as backshell separates (not mortar deployed)
  - Ringsail Parachute – heritage from Earth flights at low subsonic conditions

### Atmosphere: Using Neptune GRAM 2004 atmosphere

### Descent Probe: Diameter: 0.7 m

Conical Ribbon Parachute



Ringsail Parachute



3



# Communications to Orbiter

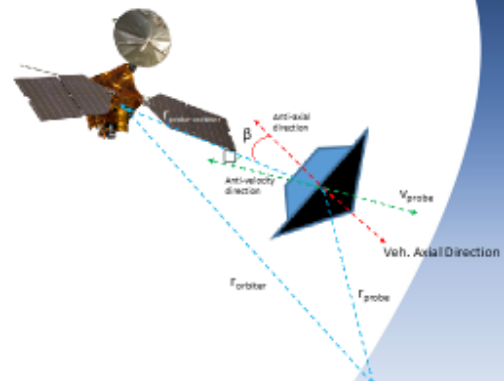
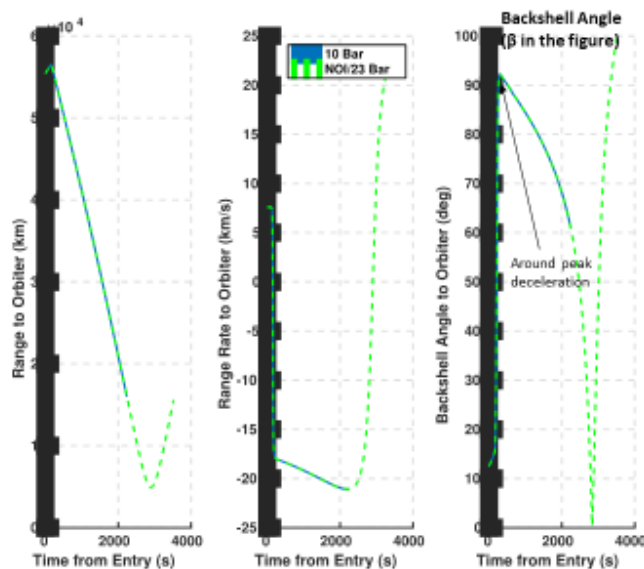

Note: Atmospheric effects and antenna pattern were not used for this analysis. This is purely geometric data

4



# Trajectory Analysis Summary



- 1<sup>st</sup> round involved downselection from 20 potential probe entry states to selection of 1 entry flight path angle state
  - Based on Ames analysis
  - Trade between manufacturability of TPS material and staying within known limits of the material
- 1<sup>st</sup> round trajectory design did not show any show-stoppers for science goals that were known
  - Max accelerations < 170 Earth g's
  - 10 bar atmosphere end-of-mission achievable within 30 mins of flight
  - 1 parachute design was initially deemed acceptable
  - 45 deg. sphere-cone geometry for entry shape usually provides stable trajectories at subsonic parachute deploy points
- 2<sup>nd</sup> round trajectory design added a descent parachute
  - Extends mission by 10 mins: Entry to 10 bar is now 40 mins of flight
  - Trajectory design like Pioneer Venus large probe and Galileo probe where descent is under parachute
- Communication to orbiter
  - During peak deceleration, probe and orbiter have potentially occultation based on geometry; expect communication reduction due to plasma blackout during that phase in general
  - Based on pure geometry between probe and orbiter, favorable orientation once vehicle is on parachute

## Concept of Operations

**Table B.34. Mission Operations and Ground Data Systems Table**

Downlink Information	Launch Support	Early Ops	Early Cruise	Cruise	Approach and Science
Number of contacts per week	3	10	3	1	7
Number of weeks for mission phase, weeks	0	4	341	418	260
Downlink frequency band, GHz	Ka-Band, 32 GHz				
Telemetry data rate(s), kbps	29 kbps				
Transmitting antenna type(s) and gain(s), DBi	4m X/Ka-Band Parabolic HGA X-Band = 47.2; 1 Ka-Band = 60.18				
Transmitter peak power, watts	Dual Band, 160				
Downlink Receiving Antenna Gain, DBi	34m Beam Waveguide, 77.8				
Transmitting power amplifier output, watts	80 Watts for Ka-Band, 12.5 Watts for X-Band				
Total daily data volume, Mb/day	1224 (For total 12 hour/day passes)				
Uplink Information					
Number of uplinks per day	3	1	3	1	1
Uplink frequency band, GHz	7.19 GHz				
Telecommand data rate, kbps	0.5 kbps				
Receiving antenna type(s) and gain(s), DBi	4m X-Band Parabolic HGA = 47.2; 0.3m Parabolic MGA X-Band = 24.7				

Data volume calculations:

29 kilobits per second = 102 megabits per hour or 12.7 megabytes per hour  
 One 12 hour pass = 1224 megabits total or 153 megabytes total

Mission operations (Ops) support begins in the design phase of the mission. The Ops team will provide input to the design to ensure operability of the system. The Ops team will work during the I&T period to further develop operational concepts and develop documentation. Additionally, the Ops team will use the I&T period to develop and execute mission-level testing such as mission simulations (MSIMs). The MSIMs will ensure that the flight and ground systems operate as expected as well as provide the ability for the Ops team exercise their processes and procedures. The



first MSIM will occur after the subsystem integration and will cover launch and early operations. The second MSIM will occur after science instrument integration and will cover instrument-related activities. A week-in-the-life MSIM will occur during thermal vacuum (TVAC) testing. Other MSIMs will be placed into the schedule to exercise the spacecraft and the probe as the schedule allows. The final MSIM will occur at the launch site before launch and will be used to complete any outstanding testing requirements.

The Ops team will support launch and early orbit activities with close to 24-h coverage for launch through launch plus 24 h. This will ensure proper execution and completion of all launch and associated burns, provide sufficient navigation data to prepare for upcoming burns, and provide data to determine spacecraft health and status (H&S). The remainder of the early operations activities include some basic instrument checkout.

During the early cruise phase, three 8-hour contacts per week will be required outside of  $\Delta$ -V maneuvers and coarse-correction burns. This will be sufficient to maintain proper H&S awareness and provide sufficient navigation data. In parallel to the on-console operations, the Ops team will continue to refine plans and rehearse for the upcoming mission phases, utilizing offline resources such as testbeds, to ensure readiness. Limited instrument checkout will occur during this timeframe. In addition, the Ops team will work to ensure that any limited science planned for this phase is properly planned and executed.

During cruise phase, the Ops team will nominally conduct one 8-hour contact per week for a brief beacon checkout. This will provide sufficient H&S of the spacecraft and probe and sufficient navigation data to sufficiently plan for the next phase of the mission. During this phase, the Ops team will rehearse probe release and Neptune orbit operations in preparation for science collections. As with early cruise phase, instrument checkouts will occur and science collects can be executed.

The Ops team will plan for one 8-hour pass per day during the approach and Neptune orbit phase. These passes will account for H&S and navigation data. During approach, the spacecraft instruments will have a more detailed checkout, and final preparations are made for probe release and on-orbit operations. Upon final approach, the Ops team will execute the probe release sequence. The probe will coast for 30 days before entry into the Neptune atmosphere. There is no real-time communication from the ground to the probe. Therefore, the probe operations will be preplanned and autonomous. The probe will communicate with the spacecraft, and the data will be stored and forwarded during a contact.

During the Neptune orbit phase, there will be a highly coordinated sequence of planning to plan for instrument collection sequences, spacecraft attitude adjustments, orbit corrections and recorder playbacks of data. The Ops team will work to ensure that all data collected are properly downlinked and delivered to the various engineering and science instrument teams. At end of mission, the Ops team will make all necessary preparations for proper pacification of the spacecraft and ensure proper disposal.



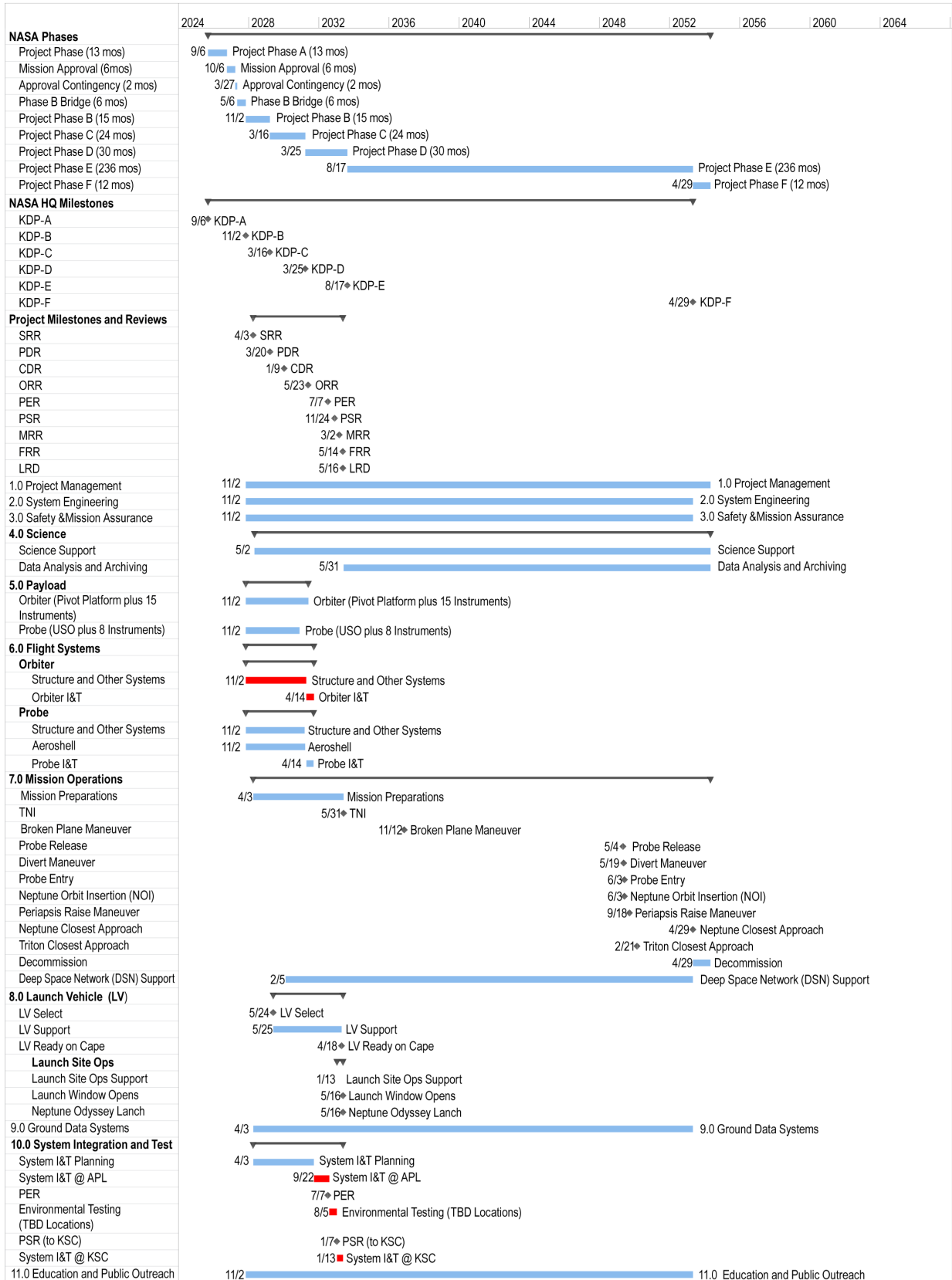

Figure B.10. Summary schedule.

# Mission Life-Cycle Costs

## Mission Ground Rules and Assumptions

- Estimating ground rules and assumptions are derived from revision 4 of the “Decadal Mission Study Ground Rules” dated November 22, 2019.
- Cost estimates are reported in FY25 dollars using the level-2 (and level-3 where appropriate) work breakdown structure (WBS) provided in NPR 7120.5E.
- The NASA New Start inflation index from the Planetary Mission Concept Studies Headquarters (PMCS HQ) is used to adjust historical cost and parametric results to FY25 dollars where necessary.
- For cost estimating purposes, mission responsibilities are as follows: APL will lead the Neptune Odyssey mission and the design, development, and manufacture of the orbiter and probe. NASA Langley Research Center will deliver the entry and descent stage (EDS). Multiple organizations will deliver orbiter and probe instruments. APL will manage Phase D system I&T and then lead mission operations and final analysis and archiving through Phase F.
- Because all components are at or above technology readiness level (TRL) 6, the mission described in this report does not require Technology Development dollars to advance components to TRL 6 by preliminary design review (PDR).
- NASA will provide the mission with three next-generation RTGs (NGRTGs) and as many as 20 RHUs on schedule for \$120M (\$75M for first flight unit; \$25M for second and third flight units) and \$5.7M, respectively. Per guidance, the mission will provide \$38M in funds to ensure launch compliance.
- Absent PMCS HQ guidance, the mission assumes that a launch vehicle (LV) meeting its performance requirements will be available in time to support a mid-2033 launch. Prices for the WBS 08 items—LV, large-diameter fairing, and upper stage—are extrapolated from current price trends.
- This estimate assumes no development delays and an on-time launch.
- Phase A–D cost reserves are calculated as 50% of the estimated costs of all components excluding WBS 08, RHUs, and NGRTGs; Phase E/F cost reserves are calculated as 25% of the estimated costs of all elements excluding the Deep Space Network (DSN).

## Instrument Costs

The instrument cost tables include costs for 14 orbiter instruments and 8 probe instruments. With few exceptions, the NICM VIII system-level model provided the primary costing method. Resulting estimates tend to be equal to or higher than cross-checks from NICM or CADRe reports of analogous instrument costs because NICM (1) assumes the starting point of instruments is TRL 6, even for copies, and (2) modifications of heritage designs are few. Primary cost estimates and cross-check estimates for orbiter instruments and probe instruments are shown in [Table B.35](#) and [Table B.36](#), respectively.

**Table B.35. Estimated cost of orbiter payloads (in thousands of FY25 dollars).**

WBS	Description	Primary Costing Method	Cost Using Primary Method \$FY25K	Cross-Check Method: NICM Report or Other as Noted	Cost Using Cross-Check \$FY25K	Remarks
5.1–5.3	Payload PM/SE/MA	Historical Factor	\$29,208	Historical Factor	\$29,654	Historical factor based on APL's history of managing Parker Solar Probe, Van Allen Probes, and other missions with instruments from other organizations
5.4	Alice	NICM System-Level	\$15,099	New Horizons Alice [APL]	\$11,485	Rosetta ALICE per NICM: \$11,584K
5.5	Ralph	NICM Subsystem-Level	\$60,641	L'Ralph (Lucy)	\$64,851	Prior New Horizons Ralph (\$47.188M) did not include scan mirror. Lucy L'Ralph, the true Neptune orbiter predecessor, includes scan mirror and larger optics.
5.6	LORRI	NICM System-Level	\$23,872	L'LORRI (Lucy EAC)	\$29,000	Lucy LORRI is a long-range, high-resolution imaging instrument. Its estimate-at-completion is high because the instrument is being developed as a stand-alone payload that has experienced schedule changes. Neptune L'LORRI primary estimate is comparable to that of Lucy hardware and software.
5.7	Diviner	NICM System-Level	\$22,490	SEER-Space Estimate	\$25,248	LRO Diviner was a multi-channel solar reflectance and infrared radiometer.
5.8	INMS	NICM System-Level	\$43,178	Cassini INMS	\$34,431	
5.9	Juno JADE-I	NICM System-Level	\$14,387	Juno JADE – NICM	\$40,265	Juno JADE incl. shielding, electronic box, one JADE-I sensor, and three JADE-E sensors
5.10	Juno JADE-E	NICM System-Level	\$21,433			Neptune orbiter requires electronics and two copies each of JADE-E and JADE-I sensors
5.11	EPI-Lo	NICM System-Level	\$15,505	SEER-Space Estimate	\$12,436	
5.12	Ultra	NICM System-Level	\$25,797	SEER-Space Estimate	\$16,744	Similar to JUICE JENA [see <a href="https://imap.princeton.edu/instruments/imap-ultra">https://imap.princeton.edu/instruments/imap-ultra</a> ]. JENA consists of only one copy and utilizes a thinner film.
5.13	Laser Altimeter	NICM System-Level	\$21,815	MESSENGER Mercury Laser Altimeter (MLA)	\$20,790	SEER-Space Estimate: \$26.723M
5.14	Waves	NICM System-Level	\$10,330	Juno Waves (incl. shielding?) – CADRe	\$15,089	Juno Waves per NICM (incl. shielding): \$22,576K
5.15	Magnetometer	NICM System-Level	\$7,090	MESSENGER MAG	\$5,861	Boom included in primary estimate. MESSENGER boom was 3.6 m in length.
5.16	Microwave Radiometer	NICM System-Level	\$56,366	Juno MWR – CADRe	\$67,166	Juno MWR per NICM (incl. shielding): \$78,396K
5.17	IDEX (Interstellar Dust Explorer)	NICM System-Level	\$15,144	IMAP/IDEX	\$15,144	IMAP/IDEX cost actuals not available. SEER-Space estimates cost as \$6,654K
5.18	EPO Cam	NICM System-Level	\$3,044	SEER-Space Estimate	\$3,125	Incl. \$530K for boom. Comet and Visible Imager: CIVA-P: 7 identical cameras. CIVA-M: Vis & IR microscopes.
<b>Orbiter payloads, excluding PM/SE/MA</b>			<b>\$356,192</b>		<b>\$361,636</b>	
<b>Orbiter payloads, including PM/SE/MA</b>			<b>\$385,400</b>		<b>\$391,290</b>	

**Table B.36. Estimated cost of probe payloads (in thousands of FY25 dollars).**

WBS	Description	Primary Costing Method	Cost Using Primary Method \$FY25K	Cross-Check Method: NICM Report or Other as Noted	Cost Using Cross-Check \$FY25K	Remarks
PP.1-PP.3	Payload PM/SE/MA	Historical Factor	\$4,428	Historical Factor	\$4,899	Historical factor based on APL's history of managing Parker Solar Probe, Van Allen Probes, and other missions with instruments from other organizations
PP.4	Mass Spectrometer	NICM System-Level	\$22,412	Galileo Probe Neutral Mass Spectrometer (NMS)	\$22,151	Class B NMS was TRL 5 at start, 13 kg mass, 25 W max. power, 0.03 kbps max. data rate; 96 months design life
PP.5	Helium Abundance Detector	NICM System-Level	\$3,453	SEER-Space Estimate	\$7,751	HAD was a U Bonn optical interferometer—1.4 kg mass, 0.9 W avg. power, 0.004 kbps bit data rate (avg).
PP.6	Atmospheric Structure Instrument (ASI)	T e	\$5,590	Galileo ASI	\$7,751	SNAP Study ASI CBD Design (incl. accel, therm, pressure)
PP.7	Ortho-Para H <sub>2</sub> Detector	NICM System-Level	\$4,446	SEER-Space Estimate	\$4,197	Banfield - TRL4/5 ortho-para instrument outgrowth of MSA, includes boom, 2 × 4" × 6" electronics, 1 W
PP.8	Nephelometer	NICM System-Level	\$7,137	Galileo NEP	\$7,656	Class B Galileo Nephelometer used 9000 A GaAs LED source. TRL 6 at start. 4 kg mass, 5 W max. power, 6 detection bands, 0.26 kbps max. data rate, 96 month design life
PP.9	Net Flux Radiometer	NICM System-Level	\$8,158	Galileo NFR	\$6,863	Class B Galileo Net Flux Radiometer used 6 Li tantelated detectors for multiband detection. TRL 6 at start. 3 kg mass, 5 W max. power, 0.26 kbpc data rate. 96 month design life
PP.10	EPO Instrument (color framing camera)	NICM System-Level	\$2,802	SEER-Space Estimate	\$3,377	COTS electronics
<b>PROBE instruments, excluding PM/SE/MA</b>			<b>\$53,998</b>		<b>\$59,746</b>	
<b>PROBE instruments, including PM/SE/MA</b>			<b>\$58,426</b>		<b>\$64,645</b>	

## Costing Methodology and Basis of Estimate

The Neptune Odyssey concept maturity level (CML)-4 mission cost estimate results from the merger of parametric cost model results, bottom-up estimates (BUEs), and cost histories of analogous items. It incorporates technical and cost uncertainties in the estimating process. No attempt was made to remove the costs due to manifested risks from the heritage data or model results. In other words, before reserves are applied, the baseline estimate already includes a historical average of cost risk. This non-adjustment is appropriate for capturing risk and uncertainty commensurate with early formulation stages of a mission. The following paragraphs describe the basis of estimate (BOE) for major elements whose estimated costs and cross-checks are shown in [Table 5.1](#).

### WBS 01, 02, 03 Project Management, Systems Engineering, Mission Assurance (PM/SE/MA)

Because mission and organizational characteristics determine the scope of PM/SE/MA activities, estimates based on relevant analogous missions are preferred over generic parametric model results. APL<sup>31</sup> has conducted thorough and rigorous analysis of mission PM/SE/MA costs for robotic

missions managed by APL and NASA Centers. It found that mission hardware cost is a reliable predictor of these critical mission function costs. The PM/SE/MA cost factor for Neptune Odyssey—15.9% of the flight system (payload + spacecraft + system I&T)—is calculated from historical PM/SE/MA data from New Horizons, Van Allen Probes, and Parker Solar Probe. Van Allen Probes and Parker Solar Probe are particularly relevant to Neptune Odyssey because they comprise APL’s most recent missions, met the current NASA requirements of NPR 7120.5E and NPR 7123 (e.g., Earned Value Management System [EVMS]), and delivered on schedule and within budget.

The estimated cost of Phase A activities is included in the PM/SE/MA element. Phase A is estimated as 2% of the estimated cost of non-WBS 08 (Launch Vehicles & Services) Phase B–D elements. The lack of technology development activity helps keep Phase A costs relatively low.

## **WBS 04 Science**

This element covers the managing, directing, and controlling of the science investigation before launch. It provides for the costs of the Principal Investigator (PI), Project Scientist (PS), and science team members. It includes \$4.5M for Science Operations Center (SOC) development and updating of the SciBox instrument scheduling framework as well as a level of effort of ~15 full-time-equivalent staff. The estimated science team labor yearly cost during Phases B–D of \$6.2M is more than twice that of MESSENGER, which expended \$2.3M (FY25) per year. That ratio is consistent with the fact that the number of Neptune Odyssey instruments—more than twice that of MESSENGER—necessitates a larger science team.

## **WBS 05 Payload**

This element covers the estimated costs of a total of 22 instruments—14 on the orbiter and 8 on the probe. See [Table B.35](#) and [Table B.36](#). Instrument cost estimates resulted from an iterative effort between cost analysts, scientists, and engineers to ensure that each estimate adequately captures instrument heritage, risks, and the activities required to develop, build, and test it. Almost all of the baseline estimates were generated with the eighth edition of the NASA Instrument Cost Model (NICM VIII, system-level). For most US instruments, those estimates were cross-checked against heritage instrument costs reported in CADRes (NASA cost reports) or NICM. The SEER-Space parametric model was utilized as a parametric cross-check and to estimate the cost of IBEX. At the aggregate level, the baseline cost of the two instrument suites is within 1% of aggregate cross-check results. Small differences were randomly distributed, consistent with the fact that almost all of the instruments are defined as very similar to the successfully flown instruments on which they were based and for which cost data are available.

**Payload PM/SE/MA.** The payload PM/SE/MA cost estimate of \$33.6M is based on a cost factor of 8.2% of instrument costs. The factor is derived from analysis of the cost histories of Van Allen Probes, New Horizons, MESSENGER, and Parker Solar Probe instruments.

**Orbiter Instruments.** Except for Diviner, all orbiter instruments are derived from remote-sensing instruments that have flown on missions such as Juno, New Horizons, Parker Solar Probe, and MESSENGER. With a few exceptions—for example, adding a filter wheel to LORRI, extending the spectral range from 3.8 to 5  $\mu\text{m}$  for the LEISA component of L’Ralph, resizing of the Microwave Radiometer antenna, and adding more bands to Diviner—the performance of the heritage instruments is not being modified substantially. Most modifications to heritage designs are engineering changes addressing hardware mounting, spacecraft interfaces, and parts obsolescence. For

each instrument, NICM VIII system-level results provide primary cost estimates, analysis of corresponding heritage instruments, and costing cross-checks. An exception was IBEX; SEER-Space provides a template for estimating dust-collecting instruments not available in other models. Half of the cross-checks are within 20% of the corresponding primary estimates. The Remarks field of the table describes major differences between heritage instruments and the corresponding Neptune instruments, some of which account for differences between primary estimates and cross-checks.

**Probe Instruments.** All eight probe instruments are derived from successfully flown instruments. Previous versions of five were flown on the Galileo mission. NICM VIII system-level results provide primary estimates, heritage instrument costs, and cross-checks. Primary and cross-check estimates are close, with the exception of the Helium Abundance Detector, whose predecessor instrument was built by University of Bonn and whose cost is unavailable. Both parametric models estimate the cost of the instrument will be less than \$8M.

## WBS 06 Spacecraft

This element includes the orbiter, Neptune probe, and an EDS that encapsulates the probe. The BOE relies primarily on TruePlanning parametric estimates generated at the component level. Those results were cross-checked at the subsystem level against SEER-H parametrics or, in the case of the propulsion and RF subsystems, historical costs and vendor prices. The level of detail and design in the Master Equipment List (MEL) allow for specific tailoring of subsystem component technologies and applications. The resulting estimates include design, fabrication, and subsystem-level testing of all hardware components. All hardware development costs include the required supporting engineering models (EMs), breadboards, flight parts, ground support equipment (GSE), and flight spares identified in the MEL. As [Table 5.1](#) shows, the primary and cross-check estimates generally agree.

**Orbiter.** The most expensive orbiter subsystem is the EPS at \$168.4M; electrical power relies on three NGRTGs to be provided to the mission for \$120M (\$75M for the first flight unit, \$25M for the second and third flight units). The remaining EPS costs are for two PSUs (\$21.4M), a shunt regulator unit (\$12.7M), and shunt dissipaters (\$9.8M). These parametrically generated estimates have been reviewed by EPS leads, considering nonrecurring engineering (NRE) for similar Parker Solar Probe and New Horizons hardware. The second most expensive subsystem is the \$38.2M propulsion subsystem whose BUE was based on component costs and historical labor cost data. That estimate is within 6% of the TruePlanning estimate. The communications subsystem estimate of \$37.0M accounts for NRE for a 5-m-diameter HGA dish based on cost data from the Europa Clipper dish and NRE to add UHF capabilities to the Frontier radios.

**Probe.** The \$49.0M probe is released as the orbiter approaches NOI and travels for 60 days, collecting and transmitting data to the orbiter via UHF. It includes a small and relatively simple structure (\$8.0M), a \$7.2M EPS that delivers power from a battery to instruments, and a \$15.7M UHF telecommunications system. The bulk of that cost is for the two small UHF radios, which require NRE similar to Frontier radio development activities. The estimated cost of the radios is \$6.5M; estimates have been confirmed by the telecommunications lead.

**Thermal Protection System (TPS).** The \$43.0M TPS that protects the probe as it traverses the outer Neptune atmosphere for 60 days consists of a HEEET heat shield (\$21.5M) and Phenolic Impregnated Carbon Ablator (PICA) backshell (\$5.7M) comprising a TPS, two relatively small (subsonic) parachutes (\$1.7M), separation hardware (\$3.0M), and structures (\$4.6M) that support the TPS. To



cross-check the TruePlanning and SEER-H estimates, which are in close agreement, TPS components and parachutes were estimated with unique, non-mass-driven CERs and a 9-EDS cost data set developed under the auspices of Marshall Space Flight Center. The 1.6-m-diameter probe TPS falls near the middle of the data set. The cost estimate results are within 5% of those generated by the mass-based SEER-H estimate for structures of extensively modified exotic materials.

### **WBS 07 & 09 Mission Operations (MOps) & Ground Data Systems (GDS) (Phases A–D)**

The pre-Phase-E MOps estimate of \$32.9M includes the following:

- MOps planning and development, network security, data processing, mission management, and prelaunch operations—estimated by TruePlanning (\$14.1M)
- Prelaunch operations—also estimated by TruePlanning (\$8.5M)
- Postlaunch operations through the first 90 days, and checkout—which are estimated by the Mission Operations Cost Estimation Tool (MOCET) model also used to estimate Phase E (\$10.3M)

A cross-check is provided by cost data from New Horizons, a nuclear, outer-planet mission. The Neptune MOps estimate is within 10% of New Horizons history, adjusted for fiscal year.

### **WBS 08 Launch Vehicle and Services**

Neptune Odyssey requires an expendable LV with heavy-lift capabilities, a large-diameter fairing, and a compatible upper stage. None of these corresponds to options described in the Decadal Survey Ground Rules. Prices included in this estimate are based on predicted trends in the prices of capabilities—SLS Block 2, SLS 8.4-m-diameter fairing, and SLS-compatible upper stage—that will be required. The element also includes compliance costs defined in the Ground Rules for use of NGRTGs (\$26M) and RHUs (\$12M).

### **WBS 10 System Integration & Testing (I&T)**

This element covers the efforts to assemble the orbiter, integrate the spacecraft and the instruments to the spacecraft, deliver and operate testbeds and support equipment, and perform spacecraft environmental testing. The costs are based on a detailed analysis of cost actuals from previous APL missions, including MESSENGER, New Horizons, STEREO, Van Allen Probes, and Parker Solar Probe. The system I&T effort is estimated as 12.7% of the costs of WBSes 05 and 06, or \$112.4M. For the conduct of risk analysis, both the cost factor and the underlying cost drivers are allowed to vary so that all sources of uncertainty can be quantified. This allows the estimate to maintain a conservative risk posture given the historical complexity of I&T.

**Phase E/F Costs.** The total Phase E/F cost of \$717.6M consists of three estimates—\$684.6M for Phase E labor, \$18.0M for a Ground Data System (GDS) refreshment 3 years before NOI, and \$15.0M for Phase F activity. The comprehensive Phase E labor estimate—covering management, science, and mission operations—was generated with MOCET 1.3, a model developed by The Aerospace Corporation and NASA Science Office for Mission Assessments (SOMA) to estimate Phase E costs. MOCET 1.3 results for the two quiescent cruises were adjusted based on APL experience. MOCET assumes the monthly cost in FY25 dollars for quiescent cruise for large, outer-planet missions is \$1.83M. APL’s New Horizons data show that the monthly cost to operate a spin-



stabilized, nuclear-powered spacecraft during quiescent cruise is about \$500K less than that average rate. Applying the New Horizons cost per month of \$1.33M during quiescent cruise reduces the MOCET-predicted Phase E estimate by 11% to \$684.6M. The GDS BUE of \$18.0M covers a complete refresh of GDS hardware and software 3 years before NOI. A rough order of magnitude of \$15.0M covers the level of effort to perform Phase F data processing and archiving.

Note that the second quiescent cruise before Neptune approach and orbital insertion is nearly 10 years of minimal activity by scientists and MOps personnel. To account for the need to hire and train personnel for the intense orbital insertion, probe release, and collection of science data, planetary approach and orbital insertion activity is modeled in MOCET as beginning 35 months before NOI. That allows sufficient time and budget to assemble and prepare MOps and science teams before the start of Neptune and Triton science operations.

**Deep Space Network (DSN) Charges.** Costs for access to the DSN infrastructure needed to transmit and receive mission and scientific data are not included in the mission cost. They are estimated for the baseline mission profile with the JPL DSN Aperture Fee tool. The total estimate of \$38.6M in FY25 dollars covers \$1M in Phase D charges for DSN tool and database setup, pre- and post-contact activity for each DSN session, as well as actual contact time.

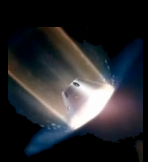

# Odyssey Neptune: Summary of Probe Entry Environment Estimation & HEEET TPS Sizing

July 1, 2020

NASA Ames Research Center

Gary Allen, Jay Feldman, Dinesh Prabhu, Joseph Williams

# Outline



- HEEET background
- Round #1 Analysis Summary (wide entry trade space)
- Round #2 Analysis Summary (refined entry interface, vehicle trade study)
- Official Trajectory + DPLR solutions for 275 kg entry mass
- HEEET TPS Sizing from high fidelity CFD
- Backshell Mass ROM Estimate

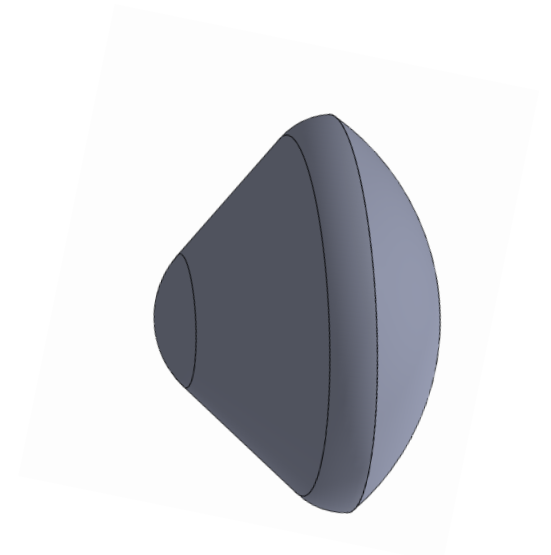

# HEEET Overview

## Heatshield for Extreme Entry Environments Technology



- **HEEET is an integrally 3-D woven, dual-layer, resin infused, ablative system**
  - An efficient, optimized, carbon phenolic TPS using modern manufacturing & materials
- **Dense outer recession layer (RL)** is designed to be robust in highest heat flux & pressure environments
- **Inner insulation layer (IL)** handles the heat load with its lower density & thermal conductivity yielding reduced TPS mass fraction
- Existing 3D loom capabilities **constrain manufacturable layer thicknesses** (~5.5 cm)
- Tiled arrangement requires seams
  - Seam material derived from the acreage material
- Scalable & tailorable for a wide variety of missions
- A full campaign of aerothermal + structural testing, system testing, & model validation enabled TRL 6 for tiled HEEET to ~4m diameter

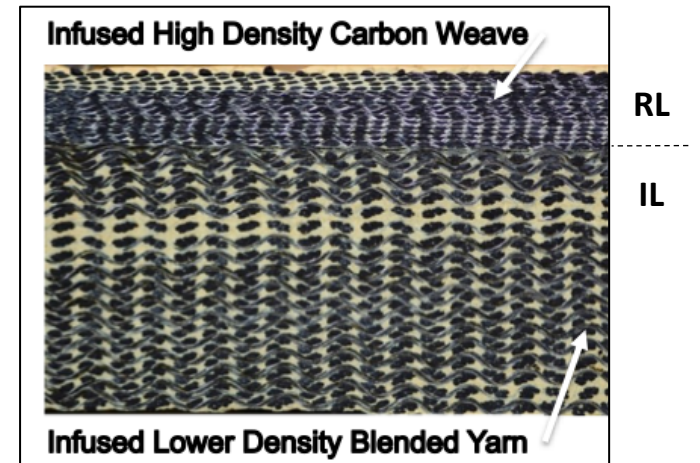
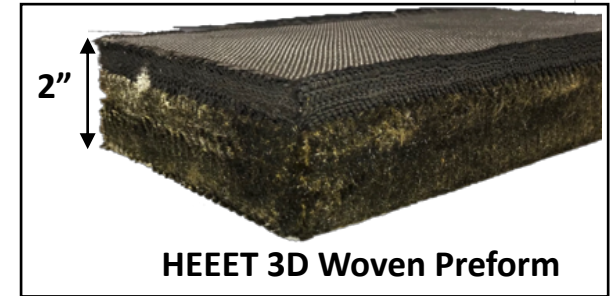

1-meter diameter HEEET engineering test unit

**Mission designs need to consider manufacturing limitations (thickness)**

# HEEET Arc Jet Testing Overview with Notional Mission Environments

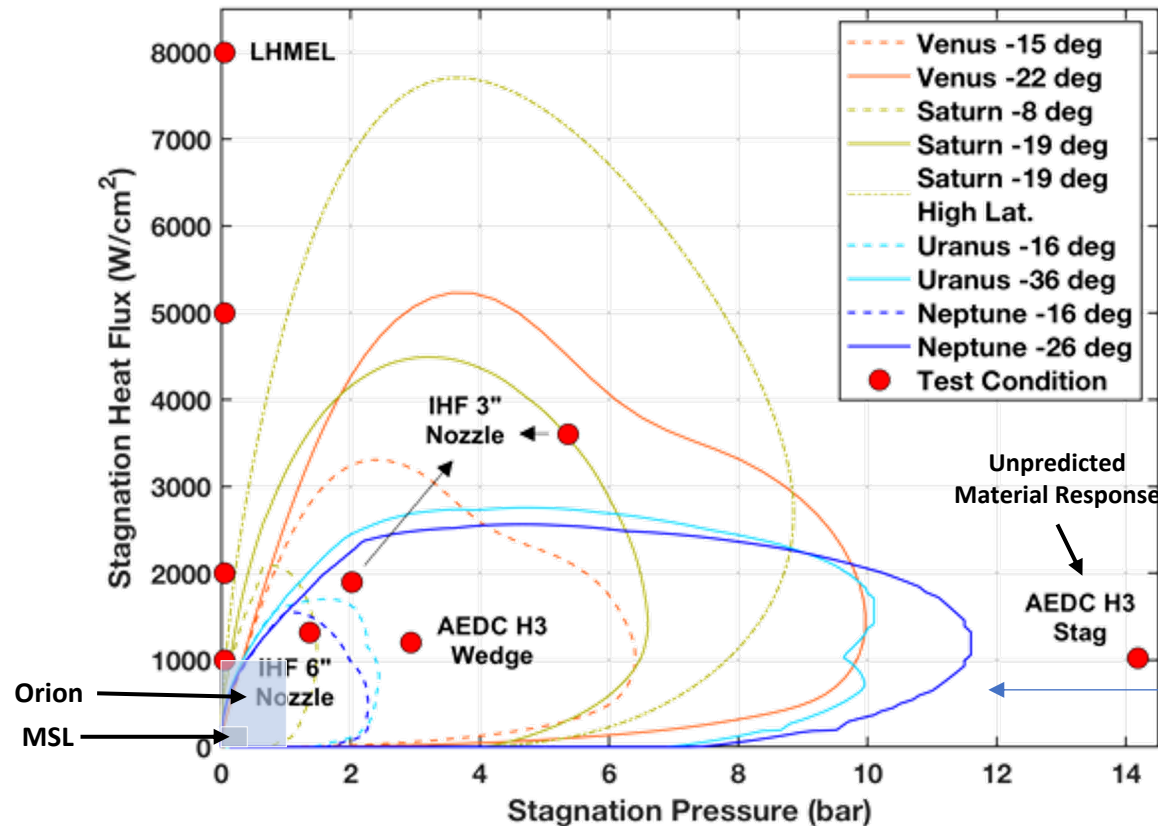

Neptune bounding range in prior studies is like that initially explored by Odyssey Neptune

- HEEET has been demonstrated up to  $\sim 3600 \text{ W/cm}^2$  and  $\sim 5.4 \text{ bar}$  pressure (convective heating)
  - Up to  $8000 \text{ W/cm}^2$  in radiative heating
- Extension to  $\sim 5000 \text{ W/cm}^2$  and  $\sim 6.5 \text{ bar}$  pressure is considered low risk
- While HEEET was tested at 14 bars pressure and did not fail, material response was unpredictable

# Round #1 Estimated Environments & HEEET Sizing for a Wide Range of Entry Interface States



Sampling of Entry Heating from a Range of Entry Interface States

EFPA [inertial] deg	Decel-eration# g	Max Stag. Pressure bar	Max Stag. Heat Flux@ W/cm <sup>2</sup>	Heat Load J/cm <sup>2</sup>	HEEET RL Thickness* cm	HEEET IL Thickness* cm	HEEET Mass kg
-15.2569	100	4.2	2330	82524	2.61	1.03	63.8
-17.8127	147	6.5	2640	67889	2.35	0.85	56.4
-20.5781	191	8.8	2890	58134	2.15	0.74	51.1
-23.0262	228	10.7	3080	52037	2.01	0.68	47.5
-25.2496	258	12.3	3250	47739	1.90	0.64	44.8



# from LaRC's POST2 analysis

@unmargined

\* As-flown thicknesses. Additional weaving thickness applied for manufacturing tolerance.

- **325 kg probe; 1.26 m diameter, 45° sphere-cone; nose radius of 0.3 to 0.4 m**
- **Initial analysis explored a wide range of entry states (entry flight path angles [EFPA] from -15.2° to -25.2°)**
  - Most EFPAs (-18.4° to -25.2°) result high stag. point pressures (7-12 bars) that are beyond HEEET qualification
  - Lowest EFPAs (-15.2° to -17.2°) result in heat loads & HEEET thicknesses that are not currently manufacturable
  - -17.8° EFPA case was the sweet spot in terms of HEEET manufacturability & qualification, although the pressure is at the very edge of our 'comfort zone'
- **Note that all entries are retrograde (azimuth ~280°), which significantly increases the aeroheating environments relative to prograde entry (heatshield mass for retrograde is 1.5 times that of prograde at Neptune)**

# Round #1 HEEET Weaving Capability & Initial Odyssey TPS Sizing

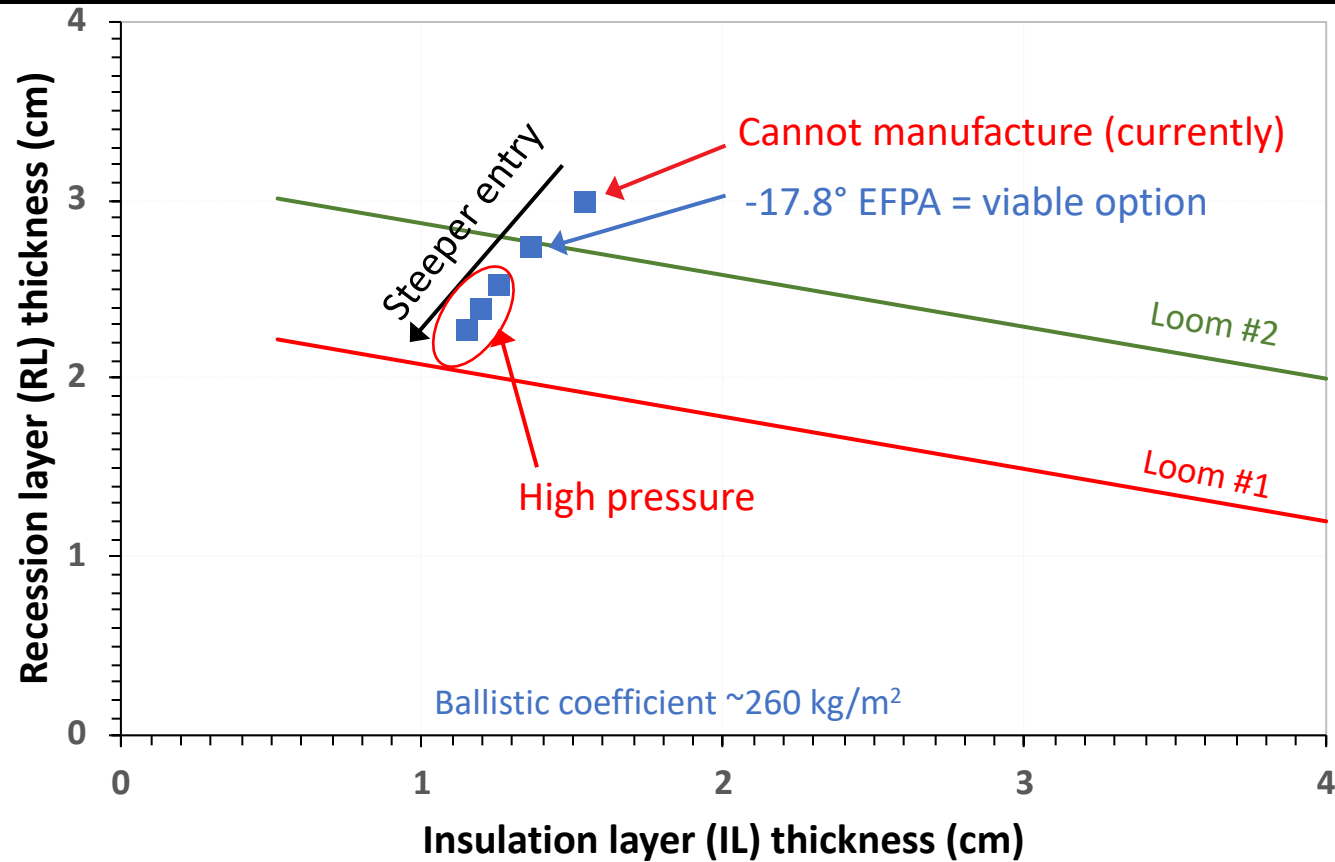

\*Max thickness capability shown for 2 loom options  
\*Sizing here includes manufacturing tolerances for HEEET weave. Probe TPS thickness is less.  
\*Loom #1 is preferred due to larger panel manufacturing (60 cm vs 30 cm width)

- Increasing nose radius to 0.4 m and/or decreasing ballistic coefficient to ~200 kg/m<sup>2</sup> would open up more EFPA options



# Round #2 Entry Conditions & Variables Studied



- Atmospheric entry conditions from NASA LaRC's POST2 analysis (to 4 sig figs) →
- LaRC's trajectory was used as an input for TRAJ heating estimation: "POST2\_Neptune\_for\_ARC\_20-Apr-2020.csv"
- 325 kg probe mass used as baseline
  - 250 kg & 275 kg cases also analyzed
- 0.4 m & 0.3 m nose radii analyzed

Entry States		Units	Comments
Flight Path Angle (inertial)	-17.80	deg	
Velocity (inertial)	23.94	km/s	
Velocity (planet-relative)	26.26	km/s	Includes the speed due to retrograde orbit
Velocity (atmospheric)	26.38	km/s	Includes effect of atmosphere of Neptune rotating
Azimuth (inertial)	271.3	deg	
Altitude	1085	km	
Radial distance	25744	km	
Latitude	29.53	deg	
Longitude	163.6	deg	

# Round #2 Estimated Environments & HEEET Sizing



Case #	Probe Mass kg	Nose Radius m	Ballistic Coefficient kg/m <sup>2</sup>	Decel-eration# g	Max Stag. Pressure bar	Max Stag. Heat Flux <sup>@</sup> W/cm <sup>2</sup>	Heat Load J/cm <sup>2</sup>	HEEET RL Thickness* cm	HEEET IL Thickness* cm	HEEET Mass kg
1	325	0.3	260	165	6.7	2,696	68,276	2.40	0.83	57.0
2	325	→ 0.4	250	163	6.3	2,381	61,192	1.83	1.00	48.6
3	250	0.4	190	149	4.3	2,085	56,154	1.44	1.14	43.3
4	250	0.3	200	152	4.6	2,402	63,080	1.95	0.99	50.7
5	275	0.4	210	154	5.0	2,191	57,985	1.58	1.09	45.2

RL = Recession Layer  
IL = Insulation Layer

# from LaRC's POST2 analysis @unmargined

\*As-flown thicknesses. Additional thickness applied for manufacturing.

- **Case #1 results in a stagnation pressure (6.7 bar) far enough from existing HEEET testing (up to 5.4 bar) that qualification risk is becoming higher**
  - Test facility abilities *might* allow for qualification testing in the 6-10 bars range, but this is currently uncertain
  - Roughly \$0.5M-\$1M over 18 months to do development, including testing and response model
- **Case #2, with its blunter nose, reduces the stagnation pressure and thereby lowers qualification risk, and results in more readily manufacturable HEEET thickness with reduced TPS mass**
  - Project needs to consider impact of 0.4 m nose radius on available payload volume and potentially reduced aero stability, depending on center of gravity

# Round #2 Estimated Environments & HEEET Sizing



Case #	Probe Mass kg	Nose Radius m	Ballistic Coefficient kg/m <sup>2</sup>	Deceleration# g	Max Stag. Pressure bar	Max Stag. Heat Flux <sup>@</sup> W/cm <sup>2</sup>	Heat Load J/cm <sup>2</sup>	HEEET RL Thickness* cm	HEEET IL Thickness* cm	HEEET Mass kg
1	325	0.3	260	165	6.7	2,696	68,276	2.40	0.83	57.0
2	→ 325	0.4	250	163	6.3	2,381	61,192	1.83	1.00	48.6
3	→ 250	0.4	190	149	4.3	2,085	56,154	1.44	1.14	43.3
4	250	0.3	200	152	4.6	2,402	63,080	1.95	0.99	50.7
5	275	0.4	210	154	5.0	2,191	57,985	1.58	1.09	45.2

RL = Recession Layer  
IL = Insulation Layer

# from LaRC's POST2 analysis @unmargined

\*As-flown thicknesses. Additional thickness applied for manufacturing.

- **Case #1** results in a stagnation pressure (6.7 bar) far enough from existing HEEET testing (up to 5.4 bar) that qualification risk is becoming higher
  - Test facility abilities *might* allow for qualification testing in the 6-10 bars range, but this is currently uncertain
  - Roughly \$0.5M-\$1M over 18 months to do development, including testing and response model
- **Case #2**, with its blunter nose, reduces the stagnation pressure and thereby lowers qualification risk, and results in more readily manufacturable HEEET thickness
  - Project needs to consider impact of 0.4 m nose radius on available payload volume and potentially reduced aero stability, depending on center of gravity
- **Cases #3, #4, #5** demonstrate that lower probe mass reduces entry environments, eases the burden of qualification, and reduces the TPS mass required (and to a lesser extent TPS structure mass)

# Round #2 TPS Sizing & HEEET Weaving Capability

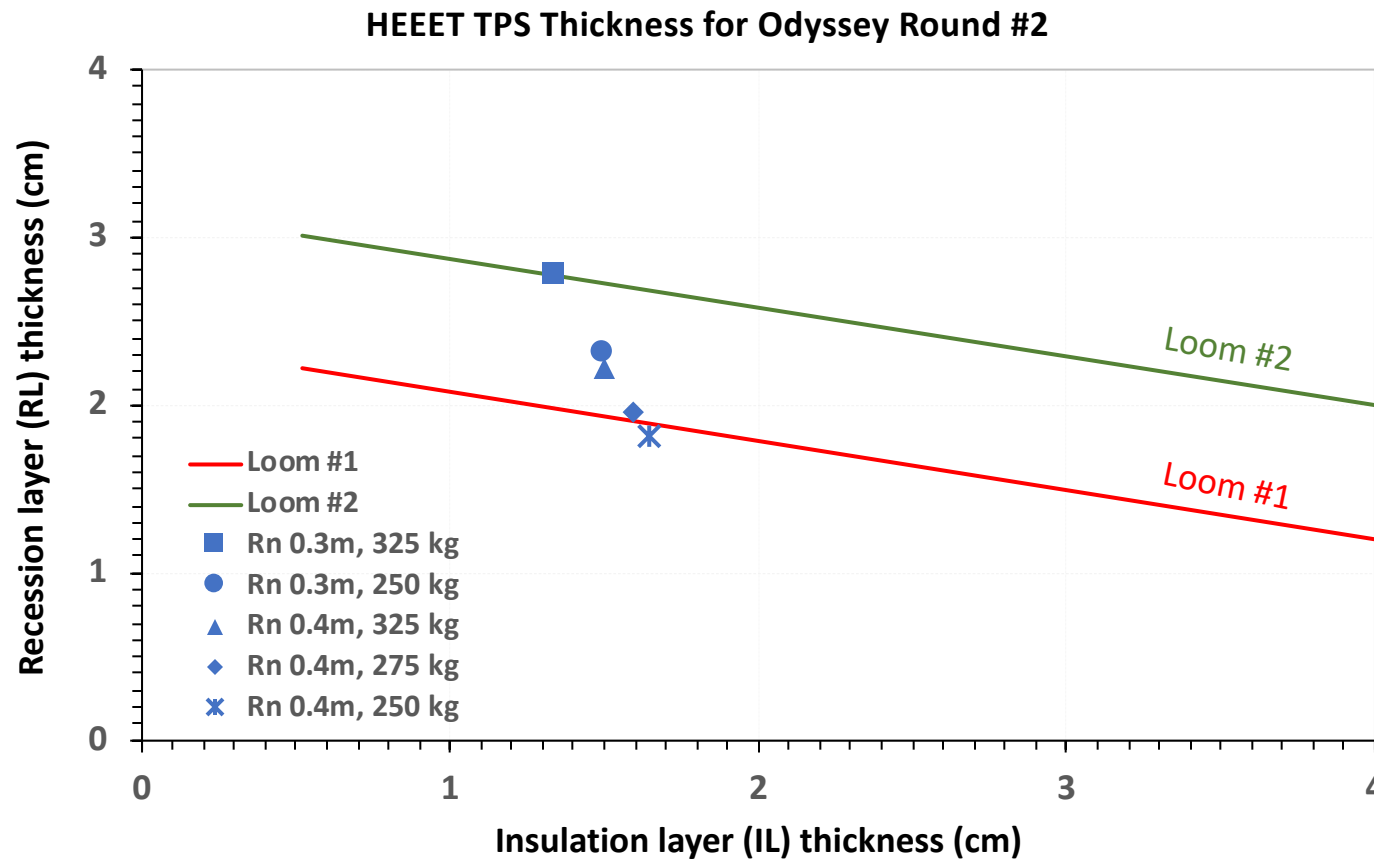

\*Max thickness capability shown for 2 loom options

\*Loom #1 is preferred due to larger panel manufacturing (60 cm vs 30 cm width)

\*Sizing shown here includes manufacturing tolerances for HEEET weaving. Probe TPS thickness is less.

- The 0.3 m nose, 325 kg probe case results in HEEET thicknesses at the limit of manufacturing capability
- Reducing probe mass results in more readily manufacturable thicknesses
- All 0.4 m nose radius cases are more readily manufacturable than the 0.3 m nose cases

# Round #3: Final Trajectory + DPLR solutions for 275 kg entry mass



After Neptune Odyssey Design Lab, the maximum expected vehicle mass was 275 kg and a nose radius of 0.4m was selected based on benefits calculated in Round #2 analysis. A POST2 Trajectory was provided by NASA Langley for this vehicle.

- 9 points in time were selected for high fidelity analysis
  - These points capture the stagnation pressure and cold wall heat flux profiles (see images to the right)
  - 1) laminar 2) turbulent (smooth) 3) turbulent-rough solutions generated at each time
- Version 4.04 of *DPLR* used in CFD simulations (if mission is selected, additional investigation is required for analysis details in red)
  - 6-species ( $H_2$ , H, He,  $H^+$ ,  $He^+$ ,  $e^-$ ) gas model
  - Thermal equilibrium assumed, *i.e.*,  $T_{vib} = T_{trans} = T_{rot}$
  - Baldwin-Lomax turbulence model – smooth and rough walls considered
  - Roughness height set to 0.4 mm (based on turbulent conditions in arc jet testing)
  - Fully-catalytic surface boundary condition with emissivity set to 0.85
    - Surface temperatures likely to be in excess of sublimation temperature of carbon!
    - Assumption of recombination reaction  $H+H \rightarrow H_2$  going to completion is questionable
- Radiative heating not included in analysis – flight velocities are less than 27 km/s
- Desired outputs for materials thermal response/sizing were provided

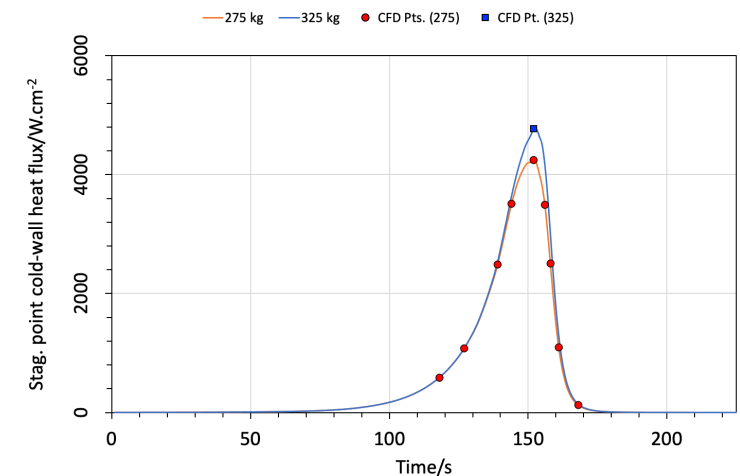
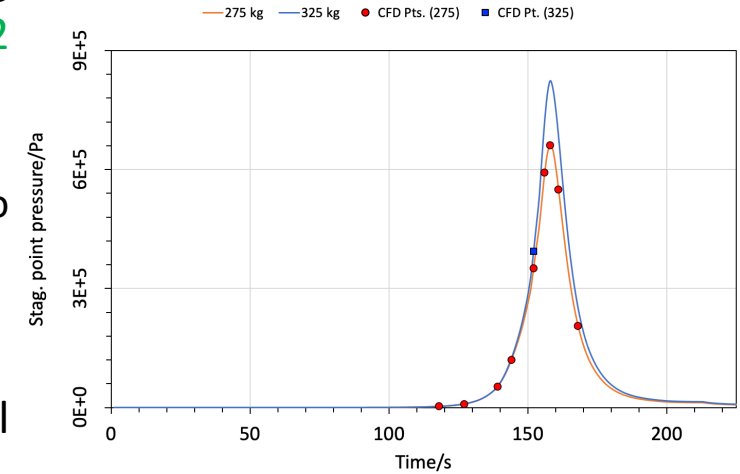

# CFD Results for 275 kg Vehicle at 152s



Example of CFD results at single instance in time is shown to the left.

$Re_{kk}$  is used as the indicated for transition from laminar flow to turbulent. ( $Re_{kk} < 200$ )

Given  $\pm 20$  uncertainty in  $Re_{kk}$  and the desire for conservatism, 152 seconds is the assumed transition time.

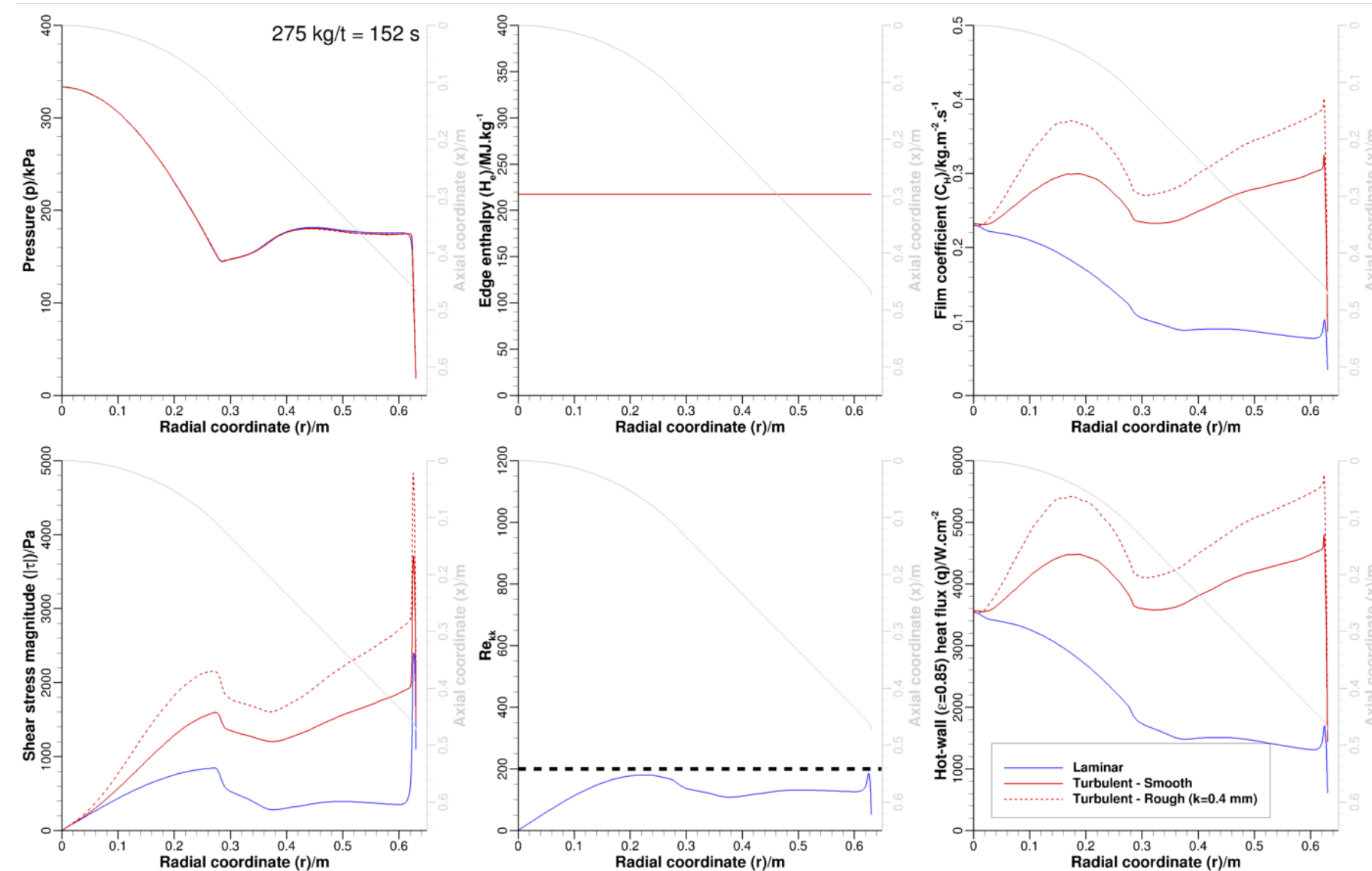

# Body Points for TPS Sizing



5 body points selected for TPS Sizing analysis. These points were evenly spread from stag point to the shoulder.

Location (measured by running length):

- Stagnation Point (0 m)
- 0.2 m
- 0.38 m
- 0.6 m
- Shoulder

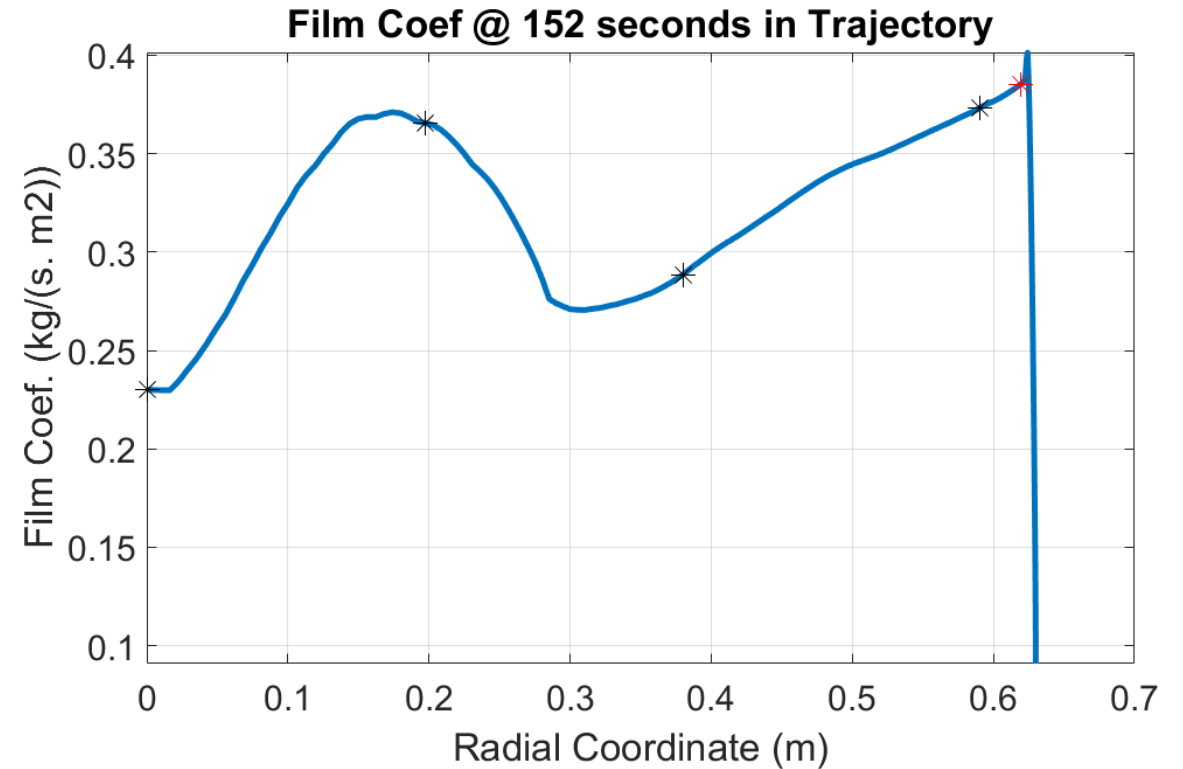
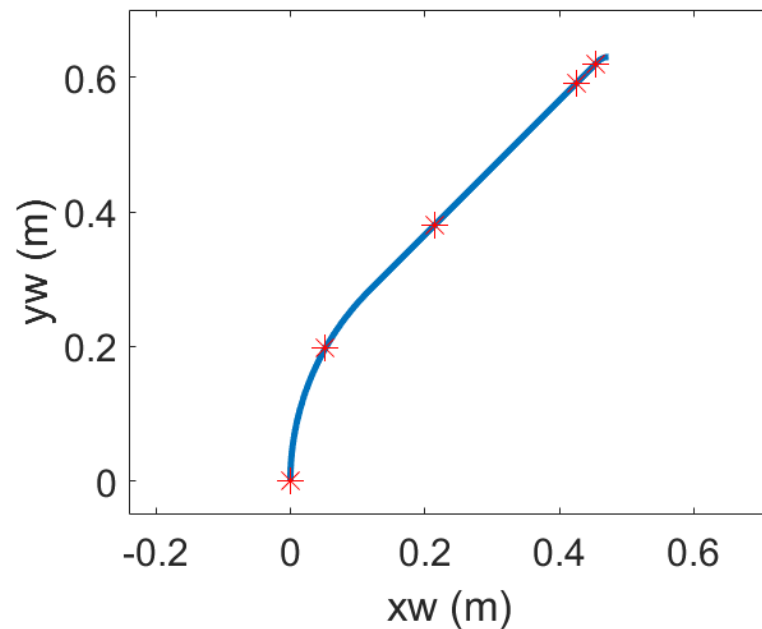

Note shoulder body point was adjusted to near the location of max CH @ 152 seconds into trajectory. (red star)



# Curve Fitting Environmental Parameters



Environmental parameters including wall pressure, recovery enthalpy, film coefficient, and wall heat flux were curve fit at all five locations given the 9 solutions in time.

- Each body point had two sets of fits for each parameter (laminar and turbulent-rough)
  - Turbulent rough was chosen for the turbulent solution based on the use of HEEET and results observed in arc jet testing

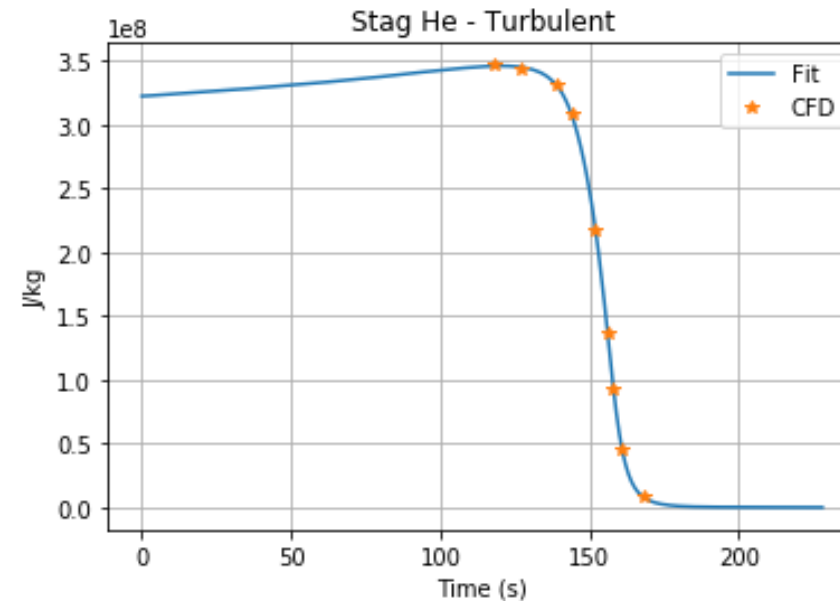
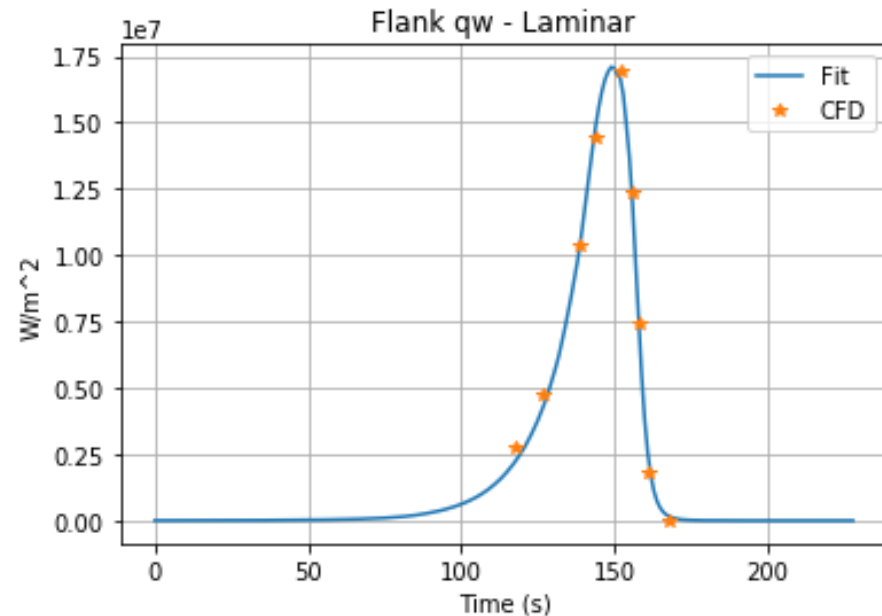

# Environmental Inputs to Sizing



## Environment File Parameters - All Body Points

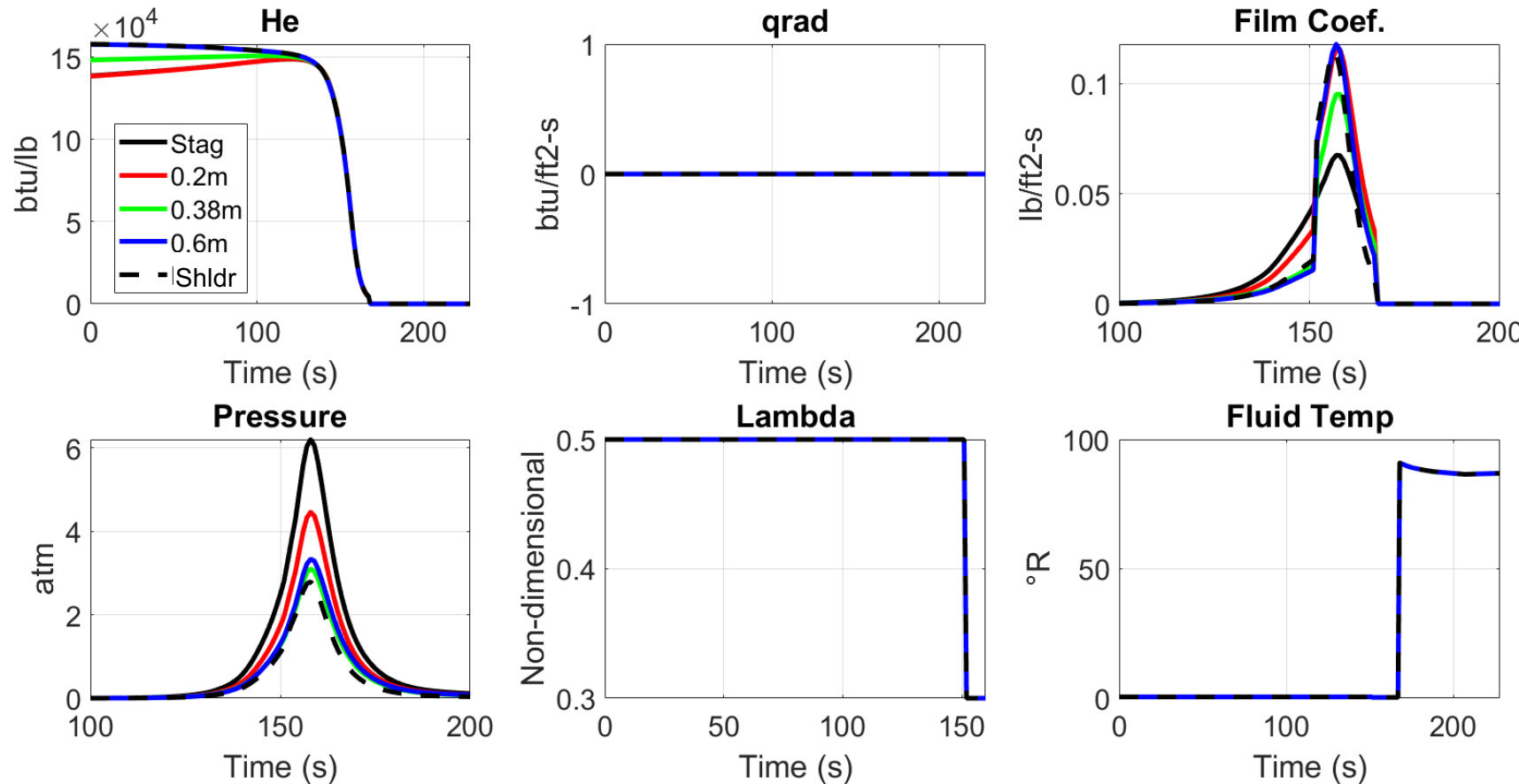

Environment Input Files were created for each body point by splicing the curve fits based on:

- Laminar-turbulent transition at 152s
- Cooling at 168 seconds.

TPS Sizing switches to cooling when the heat flux measures 1% of the maximum value in the trajectory.

Maximum Vehicle Conditions		
Condition	Pressure (atm)	Heat Flux <sup>@</sup> (W/cm <sup>2</sup> )
Max Pressure	6.2	1560
Max Heat Flux	1.7	5470

# High Fidelity HEEET Sizing



While sizing the recession layer and insulation layer of HEEET, aerothermal and material uncertainties were considered through RSS.

- Aerothermal Uncertainty: 35% increase in heat flux
- Material Uncertainty: 50% increase in recession rate to account for material property uncertainty, consistent with HEEET Margin Policy

Layers/Point	Stagnation	0.2m	0.38m	0.6m	Shoulder
Recession	0.96	1.19	0.80	0.99	1.07
Insulation	0.90	0.74	0.73	0.70	1.00

Due to the size of the Neptune probe, seams are required in the heatshield and additional margin is applied. Additional thickness for manufacturing tolerance is necessary for the as-woven product, but this material is removed before flight.

Analysis	RL Thickness (cm)	IL Thickness (cm)
3 DOF & High Fidelity CFD (275 kg)	1.48 flown / 1.63 built	1.0

Heatshield mass: **43.3 kg\***

\*Adhesive and substrate mass not included

The high-fidelity solution can be woven on existing looms. The RL/IL ratio is remarkably similar to the constructed HEEET ETU.

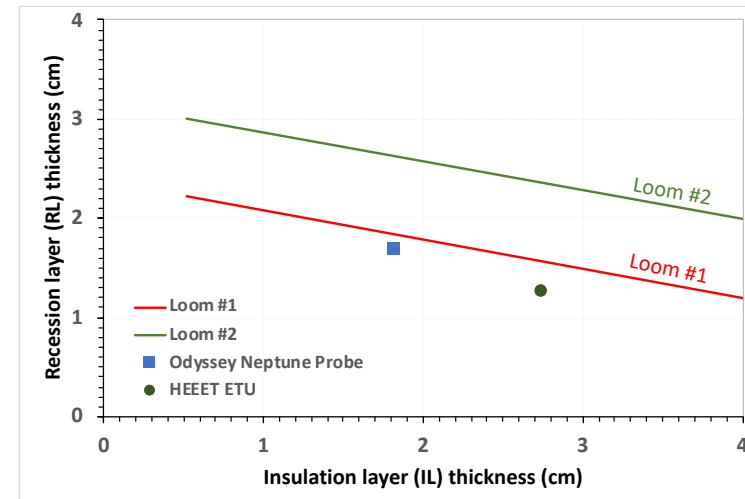

**Note:** Bondline temperature at stagnation body point reaches thermal limit at end of simulation while the temperature is still rising. Risk of adhesive overtemp is carried if heatshield separation occurs late.

# Backshell TPS Mass Estimate



## Backshell

- **A conservative rough estimate of PICA backshell TPS sizing yielded 1.94 cm thickness, 9 kg mass (adhesive included)**
  - Spherical backshell as depicted below
    - Base diameter equal to heatshield diameter (1.26 m); height from nose to backshell tip = 0.9 m
  - Stacked conservative assumptions used in a 1-D FIAT sizing analysis
    - 15% of the nominal stagnation heating (Round #1) used to account for aeroheating uncertainty:  $400 \text{ W/cm}^2$
    - Substrate heat sink removed to account for material property uncertainty
  - 10% of the nominal nominal pressure was assumed: 0.64 atm

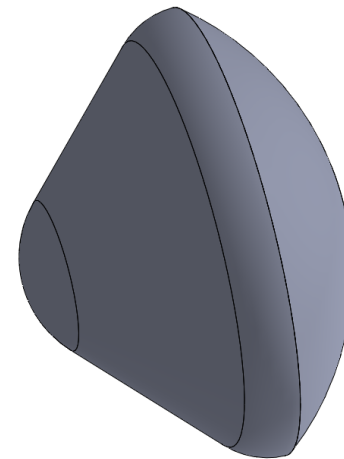

Odyssey Entry Probe

## Appendix C. References

1. Mandt, K.E., Mousis, O., Lunine, J. *et al.* Tracing the Origins of the Ice Giants Through Noble Gas Isotopic Composition. *Space Sci Rev* **216**, 99 (2020). <https://doi.org/10.1007/s11214-020-00723-5>
2. Helled, R., Nettelmann, N. & Guillot, T. Uranus and Neptune: Origin, Evolution and Internal Structure. *Space Sci Rev* **216**, 38 (2020). <https://doi.org/10.1007/s11214-020-00660-3>
3. Hueso, R., Sánchez-Lavega, A. Atmospheric Dynamics and Vertical Structure of Uranus and Neptune's Weather Layers. *Space Sci Rev* **215**, 52 (2019). <https://doi.org/10.1007/s11214-019-0618-6>
4. Fletcher, L.N., de Pater, I., Orton, G.S. *et al.* Ice Giant Circulation Patterns: Implications for Atmospheric Probes. *Space Sci Rev* **216**, 21 (2020). <https://doi.org/10.1007/s11214-020-00646-1>
5. KM Soderlund, S Stanley, The Underexplored Frontier of Ice Giant (2020). <https://doi.org/10.1002/essoar.10503671.1>
6. Amanda R. Hendrix, Terry A. Hurford, Laura M. Barge, Michael T. Bland, Jeff S. Bowman, William Brinckerhoff, Bonnie J. Buratti, Morgan L. Cable, Julie Castillo-Rogez, Geoffrey C. Collins, Serina Diniega, Christopher R. German, Alexander G. Hayes, Tori Hoehler, Sona Hosseini, Carly J.A. Howett, Alfred S. McEwen, Catherine D. Neish, Marc Neveu, Tom A. Nordheim, G. Wesley Patterson, D. Alex Patthoff, Cynthia Phillips, Alyssa Rhoden, Britney E. Schmidt, Kelsi N. Singer, Jason M. Soderblom, and Steven D. Vance. *Astrobiology*. Jan 2019.1-27.<http://doi.org/10.1089/ast.2018.1955>
7. Kivelson M.G. *et al.*, Galileo Magnetometer Measurements: A Stronger Case for a Subsurface Ocean at Europa *Science*, 25 Aug 2000, Vol. 289, Issue 5483, pp. 1340-1343, DOI: 10.1126/science.289.5483.1340
8. Hansen C., *et al.*, Triton: Fascinating Moon, Likely Ocean World, Compelling Destination! White paper to the Astrobiology and Planetary Decadal Survey, 2020.
9. Wakeford, H. R. and P. A. Dalba (2020) The Exoplanet Perspective on Future Ice Giant Exploration.
10. NASA Radioisotope Power Systems Program Next-Generation RTG Study: Summary 2017 <https://rps.nasa.gov/resources/75/nasa-radioisotope-power-systems-program-next-generation-rtg-study-summary-2017/>
11. Zakrajsek J. F. Update on RPS and Fuel Production, OPAG 2019
12. Ribes, D., S. J. Jackson, (2013). in *Raw data is an oxymoron*, L. Gitelman, Ed. MIT Press, Cambridge MA, pp. 147–166.
13. Ribes, D., T. A. Finholt, (2007). in *Proceedings of the 2007 international ACM conference on Conference on supporting group work - GROUP '07* ACM Press, Sanibel Island, Florida, USA; <http://portal.acm.org/citation.cfm?doid=1316624.1316659>, p. 229.

14. Bietz, M.J., C. P. Lee, (2009). in Proceedings of the 11th European Conference on Computer Supported Cooperative Work, 7-11 September 2009, Vienna, Austria. Springer Verlag, London, pp. 243–262.
15. Vertesi, J., P. Dourish, (2011). ACM Press, <http://portal.acm.org/citation.cfm?doid=1958824.1958906>, p. 533.
16. Lee, C. P., P. Dourish, G. Mark, (2006). ACM Press, <http://portal.acm.org/citation.cfm?doid=1180875.1180950>, p. 483.
17. Weber, M. (1968). *Economy and society; an outline of interpretive sociology*. Edited by Guenther Roth and Claus Wittich. Translators: Ephraim Fischhoff and others. Bedminster Press, New York, Wirtschaft und Gesellschaft. English.
18. Freeman, J. (1972). The tyranny of structurelessness. *Berkeley J. Sociol.* 17, 151–164.
19. Smith-Doerr, L, (2004). *Women’s Work: Gender Equality vs. Hierarchy in the Life Sciences* Lynne Rienner Publishers, Boulder, CO.
20. Vertesi, J. (2020, in press). *The Social Life of Spacecraft*. The University of Chicago Press, Chicago.
21. Linde, C. (2001). Narrative and social tacit knowledge. *J. Knowl. Manag.* 5, 160–171.
22. Sheehan, M., (2007). *The International Politics of Space*, Routledge, ed. 1.
23. Groen, B., C. Hampden-Turner, (2005). *The Titans of Saturn: Leadership and Performance Lessons from the Cassini - Huygens Mission*. Cyan Books and Marshall Cavendish.
24. Venkatapathy, E., Ellerby, E., Gage, P., et al., "Entry System Technology Readiness for Ice-Giant Probe Missions." *Space Science Reviews*, 216, no. 2 (2020): 1-21.
25. Ellerby, D. et al. “Heatshield for Extreme Entry Environment Technology (HEEET) TPS for Ice Giants Probe Missions,” Outer Planets Assessment Group (OPAG) Spring Meeting, Washington, DC, April 23-14, 2019
26. Gage, P. et al. “Technology Readiness Assessment for HEEET TPS,” International Planetary Probe Workshop, Oxford, UK, July 8-12, 2019
27. “Heat-Shield for Extreme Entry Environment Technology Thermal Margin Policy and Sizing Guide”, HEEET Project Document # HEEET-2012, Revision NC, 2019
28. E. Venkatapathy, “Ablators - From Apollo to Future Missions to Moon, Mars and Beyond,” 70<sup>th</sup> International Astronautical Congress (IAC), Washington D.C., United States, 21-25 October 2019, IAC Paper # [IAC-19,C2,4,1,x55164](#)
29. Stackpoole, M. et al. “Development of Lyocell Base Phenolic Impregnated Carbon Ablator (PICA-D) for Future NASA Missions,” National Space and Missile Materials Symposium, Henderson, NV, June 24-27, 2019
30. Ellerby, D, et. al. “Sustaining Phenolic Impregnated Carbon Ablator (PICA) for Future NASA Missions Including Discovery and New Frontiers,” International Planetary Probe Workshop, Oxford, UK, July 8-12, 2019

31. Hahn M. (2014), Higher Fidelity Estimating: Program Management, Systems Engineering, & Mission Assurance [https://www.nasa.gov/sites/default/files/files/36\\_Draft\\_Hahn\\_NASA\\_Cost\\_Symposium\\_PMSEMA\\_7\\_25\\_14.pdf](https://www.nasa.gov/sites/default/files/files/36_Draft_Hahn_NASA_Cost_Symposium_PMSEMA_7_25_14.pdf)
32. Hendrix et al. (2020). Ultraviolet-Based Science in the Solar System: Advances and Next Steps, A white paper submitted to the Planetary Science and Astrobiology Decadal Survey 2023-2032
33. Nikzad, S., Jones, T.J., Elliott, S.T., Cunningham, T.J., Deelman, P.W., Walker, A.B.C., and Oluseyi, H.M. “Ultrastable and Uniform EUV and UV Detectors.” 2000. In Proc. SPIE 4139, Instrumentation for UV/EUV Astronomy and Solar Missions, edited by Silvano Fineschi, Clarence M. Korendyke, Oswald H. W. Siegmund, and Bruce E. Woodgate, 4139:250–258.
34. Hofstadter, M. et al. (2017), Ice Giants Pre-Decadal Survey Mission Study Report, NASA, JPL D-100520.