

2015

SCIENCE MISSION DIRECTORATE

TECHNOLOGY
HIGHLIGHTS

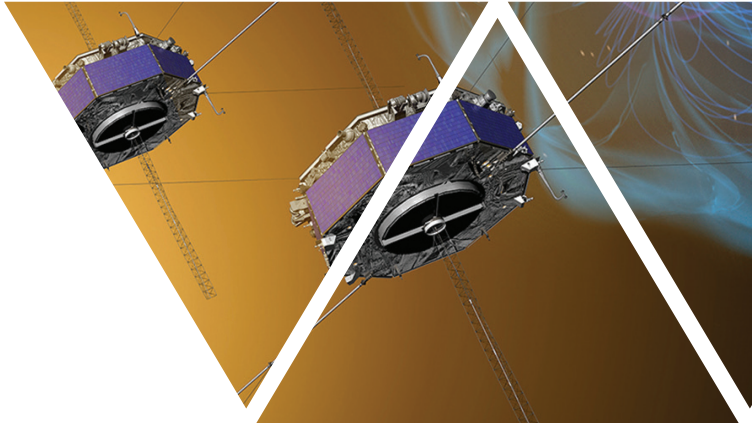

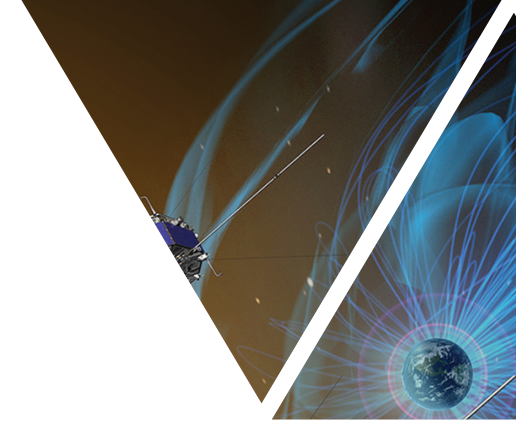
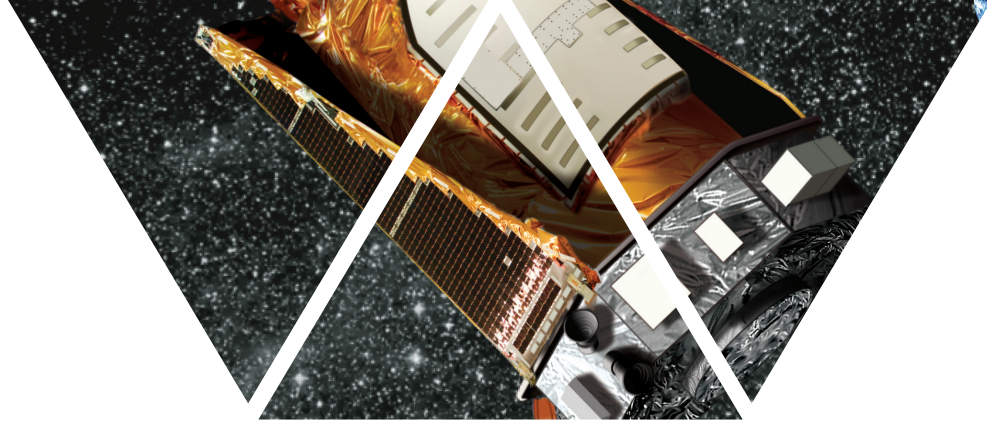
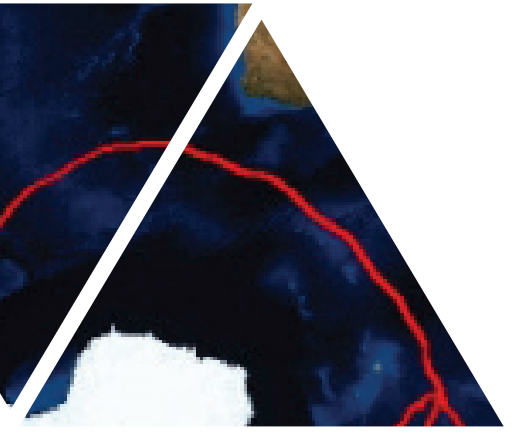
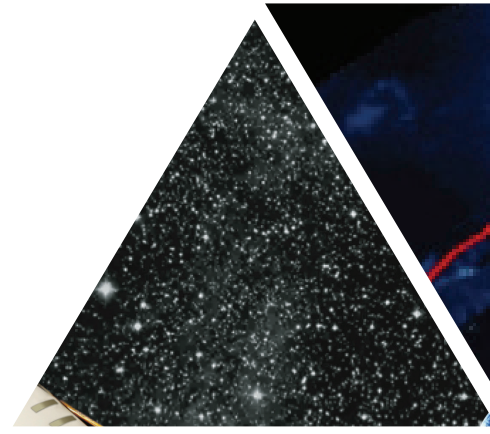

Enabling groundbreaking
science through
technological innovation...

INTRODUCTION	2
TECHNOLOGY DEVELOPMENT	5
Starshade to Enable First Images of Earth-sized Exoplanets	5
WFIRST Coronagraph: Imaging Giant Exoplanets Around Nearby Stars	6
Specialized Weaving Techniques Enable a New Heat Shield for Planetary Exploration	7
Test Flights Demonstrate New Concept for Ocean Color Retrieval	8
New Atmospheric Detector Technology Demonstrated on a CubeSat	9
Laboratory Technology Helps Unlock the Mysteries of Magnetic Reconnection	9
First Flights for CO ₂ -detecting Lidar	11
Sounding Rocket Mission Demonstrates New Technology to Measure Magnetic Fields in a Critical Region of the Sun’s Atmosphere	11
Auto-Gopher: Drilling Deep to Explore the Solar System	13
Radial Core Heat Spreader to Improve Stirling Radioisotope Generator Heat Rejection	14
NASA Investigates a Backup Cooling Device for Stirling Radioisotope Power Systems	15
Measuring Snow to Manage Water Resources	16
TECHNOLOGY INFUSION	17
Seven SMD-supported Instruments to Search for Evidence of Life on Europa	17
New Heat Shield to Protect Mission to the Sun	20
Game-changing Balloon Technology Enables Near-global Flight	21
Earth Venture Suborbital-2 Awards Include SMD-sponsored Technology Infusions	22
Mapping Hydrogen to Locate Water on the Moon	24
Tiny Thrusters Demonstrate a Capability Needed to Detect Gravitational Waves	25
Computing Advances to Enable Speedy New Rover on the Red Planet	25
New Technologies Enable Study of Magnetic Reconnection in Space	26
New System Put Into Service to Process Nepal Earthquake Data	28
APPENDIX A. THE SMD TECHNOLOGY DEVELOPMENT STRATEGY	29
ACRONYMS	32

INTRODUCTION

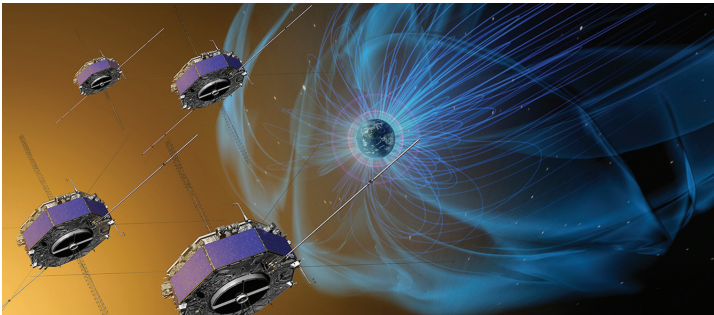
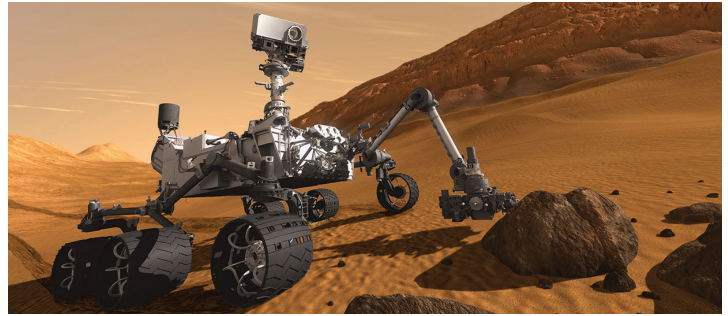
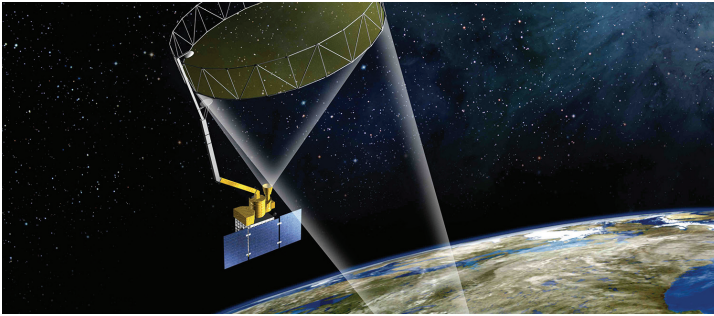

NASA missions in all four science areas have benefitted from SMD technology development investments. Clockwise from top left: the Soil Moisture Active Passive (SMAP) spacecraft, Mars Science Laboratory Curiosity Rover, Kepler, Magnetospheric Multiscale (MMS) mission.

The role of the Science Mission Directorate (SMD) is to enable NASA to achieve its science goals in the context of the Nation’s science agenda. SMD’s strategic decisions regarding future missions and scientific pursuits are guided by Agency goals, input from the science community—including the recommendations set forth in the National Research Council (NRC) decadal surveys—and a commitment to preserve a balanced program across the major science disciplines. Toward this end, each of the four SMD science divisions—Heliophysics, Earth Science, Planetary Science, and Astrophysics—develops fundamental science questions upon which to base future research and mission programs. Often the breakthrough science required to answer these questions requires significant technological innovation—e.g., instruments or platforms with capabilities beyond the current state of the art. SMD’s targeted technology investments fill technology gaps, enabling NASA to build the challenging and complex missions that accomplish groundbreaking science.

SMD DIVISION FUNDAMENTAL SCIENCE QUESTIONS

HELIOPHYSICS

- What causes the Sun to vary?
- How do the geospace, planetary space environments and the heliosphere respond?
- What are the impacts on humanity?

EARTH SCIENCE

- How is the global Earth system changing?
- What causes these changes in the Earth system?
- How will the Earth system change in the future?
- How can Earth system science provide societal benefit?

PLANETARY SCIENCE

- How did our solar system form and evolve?
- Is there life beyond Earth?
- What are the hazards to life on Earth?

ASTROPHYSICS

- How does the universe work?
- How did we get here?
- Are we alone?



NASA TECHNOLOGY READINESS LEVEL (TRL) DEFINITIONS

Source: NPR 7123.1B, NASA Systems Engineering Processes and Requirements.

The directorate works to ensure that NASA actively identifies and invests in the right technologies at the right time to enable the Agency's science program. SMD technology development is part of a comprehensive Agency-wide strategy that involves coordination with the NASA Chief Technologist and other Agency mission directorates. This coordination helps ensure that crosscutting technology development needs are identified across the Agency and that there is optimal return on investments to fulfill those needs. SMD accomplishes technology development through technology programs established in each of its four science divisions. (See table on page 4 for a list of SMD technology development programs.) If a technology development effort reaches a NASA Technology Readiness Level (TRL) that is high enough, it may be infused into an SMD flight program and targeted for further maturation, enabling its use for a specific mission application. In some cases, other programs within SMD (e.g., the Astrophysics Division's Scientific Balloon Program and the Planetary Science Division's Mars Exploration Program) sponsor technology development related to specific program objectives.

The subsequent chapters of this report highlight the most significant SMD technology development efforts of 2015. The second chapter highlights technology achievements that were sponsored by SMD technology development programs in 2015. The third chapter briefly describes highlights from recent SMD technology infusions—SMD-sponsored technologies that have been transferred to the technology user (typically a flight mission) for refinement and eventual application. Appendix A briefly reviews SMD's technology strategy and technology development process, including the feedback loop that ensures the science community both informs SMD technology investment decisions and is informed about SMD technology developments.

NASA TRL	DEFINITION
1	Basic principles observed and reported
2	Technology concept and/or application formulated
3	Analytical and experimental critical function and/or characteristic proof-of-concept
4	Component and/or breadboard validation in laboratory environment.
5	Component and/or breadboard validation in relevant environment.
6	System/sub-system model or prototype demonstration in a relevant environment.
7	System prototype demonstration in an operational environment.
8	Actual system completed and "flight qualified" through test and demonstration.
9	Actual system flight proven through successful mission operations.

SMD TECHNOLOGY DEVELOPMENT PROGRAMS

EARTH SCIENCE DIVISION (FUNDED AND MANAGED THROUGH THE EARTH SCIENCE TECHNOLOGY OFFICE, ESTO)

Advanced Component Technologies (ACT)	Develops a broad array of components and subsystems for instruments and observing systems.
Instrument Incubator Program (IIP)	Funds innovative technologies leading directly to new Earth observing instruments, sensors and systems.
Advanced Information Systems Technology (AIST)	Develops tools and techniques to acquire, process, access, visualize, and otherwise communicate Earth science data.
In-Space Validation of Earth Science Technologies (InVEST)	Enables on-orbit technology validation and risk reduction for small instruments and instrument systems that could not otherwise be fully tested on the ground or airborne systems.

HELIOPHYSICS DIVISION

Sounding Rocket Program Office	Develops new sounding rocket and range technologies; serves as a low-cost testbed for new scientific techniques, scientific instrumentation, and spacecraft technology eventually flown on satellite missions.
Heliophysics Technology and Instrument Development for Science (H-TIDeS)	Supports basic research of new technologies and feasibility demonstrations that may enable future science missions. Also supports science investigations through suborbital flights that often involve a significant level of technology development.

PLANETARY SCIENCE DIVISION

Planetary Instrument Concepts for the Advancements of Solar System Observations (PICASSO)	Funds the development of low-TRL technologies (TRL 1-4) leading directly to the development of new Planetary Science observing instruments, sensors and in situ systems.
Maturation of Instruments for Solar System Exploration (MatISSE)	Matures innovative instruments, sensors, and in situ system technologies (TRL 3-6) to the point where they can be successfully infused into new Planetary Science missions.
Homesteader	Advances Planetary Science technologies in advance of New Frontiers Announcements of Opportunity.
Planetary Science and Technology through Analog Research (PSTAR)	Provides instrument technology development coupled with systems-level field tests.
Radioisotope Power Systems Program	Strategically invests in nuclear power technologies to maintain NASA's current space science capabilities and enable future space exploration missions.

ASTROPHYSICS DIVISION

Astrophysics Research and Analysis (APRA)	Supports basic research of new technologies (TRL 1-3) and feasibility demonstrations that may enable future science missions. Also supports science investigations through suborbital flights that often involve a significant level of technology development.
Strategic Astrophysics Technology (SAT)	Develops mid-TRL technologies (TRL 3-6). Each focused Astrophysics program manages an SAT element separate from flight projects: Technology Development for Physics of the Cosmos (TPCOS), Technology Development for Cosmic Origins Program (TCOR), and Technology Development for Exo-Planet Missions (TDEM).
Roman Technology Fellowships Program	Provides opportunities for early-career astrophysics technologists to develop the skills necessary to lead astrophysics flight instrumentation development projects, and fosters career development by providing incentives to help achieve long-term positions. Develops innovative technologies that enable or enhance future astrophysics missions.

TECHNOLOGY DEVELOPMENT

STARSHADE TO ENABLE FIRST IMAGES OF EARTH-SIZED EXOPLANETS

Technology Development: Currently, astronomers can investigate Earth-sized exoplanets using only indirect methods such as detecting the changes in starlight as a planet passes in front of its star. The starshade (also known as an external occulter) is a spacecraft that will enable telescopes in space to take pictures of planets orbiting faraway stars. The starshade is designed to fly in front of a telescope and block the immense glare from a star's light before it enters the telescope, allowing the planet's reflected light to pass through and be collected. Models predict the starshade can achieve the required 10^{-10} contrast levels required to detect Earth-sized planets in the habitable zones of their stars. To successfully achieve starlight blocking, the starshade must unfurl and expand in space to almost the size of a baseball diamond (34 m diameter). The starshade's razor-sharp petals redirect the effects of diffraction—the bending of starlight around the petal edges producing unwanted glare—and create a dark shadow for the trailing telescope to fly in. The starshade and telescope are separated by as much as 50,000 km—almost four Earth diameters.

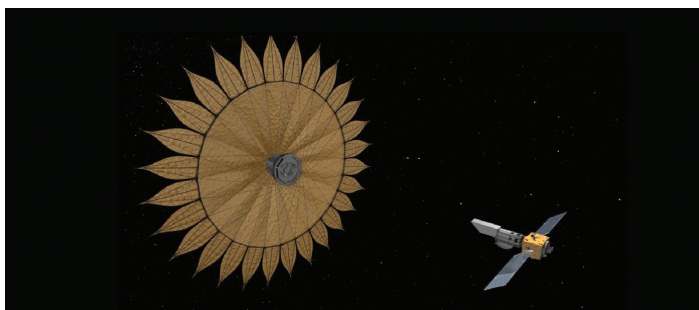

An artist's depiction of the fully-deployed starshade spacecraft (left) next to the space telescope it supports. The two spacecraft must fly in almost perfect alignment to allow the telescope to stay in the shadow created by the starshade.

Impact: The starshade and the coronagraph (also known as an internal occulter) are the two technologies NASA intends to advance to enable the first image of an Earth-like planet (for more information on coronagraph technology, see the entry on the Wide-Field Infrared Survey Telescope [WFIRST] coronagraph on page 6). Achieving the detection sensitivities required to image exo-Earths and look for evidence of life in their atmospheres is very difficult. Researchers do not know enough at this time to decide which approach will be more successful, so it is advantageous for NASA to pursue both technologies to learn more. By blocking a star's light outside of the telescope, rather than on the inside, the starshade concept significantly reduces the cost and complexity of the trailing telescope. In fact, the starshade is compatible with any type of future visible and near infrared telescope mirror—an on-axis monolith like the 2.4-m WFIRST or a large multi-segmented mirror like the 10-m-class Large Ultra-Violet Optical Infrared (LUVOIR) concept. The starshade also offers the opportunity to be launched separately, and can potentially rendezvous at a later date with any starshade-compatible telescope.

Status and Future Plans: Scaled prototypes of the starshade petals, expandable inner disk, and opaque origami shield have already been produced through NASA-funded SAT awards to Princeton University and JPL teams. Optical demonstrations by Principal Investigators (PIs) from industrial partner Northrop Grumman were conducted in 2015 across a 2-km stretch of dried lake bed in the Nevada desert. These demonstrations have helped engineers understand the starshade's capabilities. A second optical demonstration effort began in 2015 with the assembly of an enclosed 78-m testbed at Princeton University; first light is scheduled for the spring of 2016.

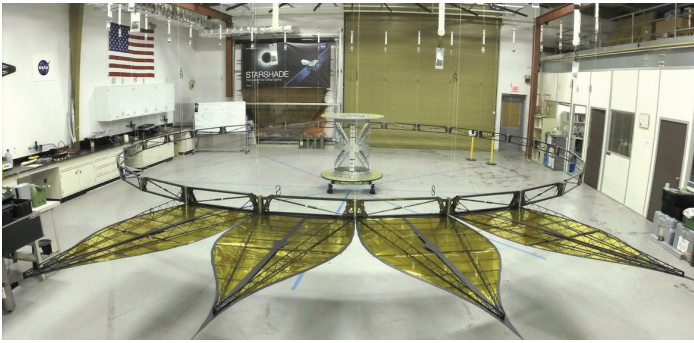

A 10-m prototype of the starshade's inner disk is demonstrated at NASA's Jet Propulsion Laboratory.

Sponsoring Organization: This technology is currently being funded through the Astrophysics Division's SAT program and Exoplanet Exploration Program. The starshade development effort is led by NASA JPL, PI Jeremy Kasdin at Princeton University, and PI Tiffany Glassman at Northrop Grumman Corporation.

WFIRST CORONAGRAPH: IMAGING GIANT EXOPLANETS AROUND NEARBY STARS

Technology Development: The Wide-Field Infrared Survey Telescope (WFIRST) is the highest-ranked recommendation for a large space mission in the NRC 2010 decadal survey, New Worlds, New Horizons (NWNH) in Astronomy and Astrophysics. The WFIRST coronagraph instrument (CGI) will be the first high-contrast stellar coronagraph in space. It will enable WFIRST to respond to the goals of NWNH by directly imaging and spectrally characterizing giant exoplanets similar to Neptune and Jupiter, and possibly even super-Earths (extrasolar planets with a mass higher than Earth's but lower than our Solar System's ice giants, Neptune and Uranus), around nearby stars. The WFIRST CGI includes both a Shaped Pupil

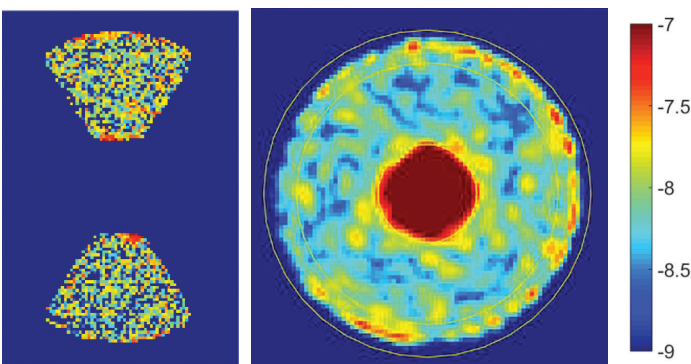

Measured milestone contrasts for the HLC (middle) and SPC (left) in a vacuum testbed in 2015, where the milestone target contrast of 10^{-8} average in the dark hole (the annular and wedge-shaped regions, respectively) was achieved for both coronagraphs, as planned and on schedule.

Coronagraph (SPC) and a Hybrid Lyot Coronagraph (HLC). All three of WFIRST's CGI technology milestones for 2015 were passed successfully. First, the HLC demonstrated a raw contrast (speckle/star intensity ratio) of 10^{-8} , using a 10% bandwidth filter in visible light (550 nm), in a static environment. Second, the SPC achieved the same milestone under the same conditions. For both the HLC and SPC, the figure above shows excellent average contrast (blue-green) over most of the field of view, and slight turn-up (red) at the inner and outer radii, as expected. The third milestone was accomplished when the Low Order Wavefront Sensing and Control (LOWFS) subsystem achieved its goal of providing sensing of pointing jitter and control at the 0.4 milli-arc-second root-mean-square (RMS) level, which will keep a target star sufficiently centered on the coronagraph star-blocking mask, when the WFIRST telescope experiences pointing drift and jitter.

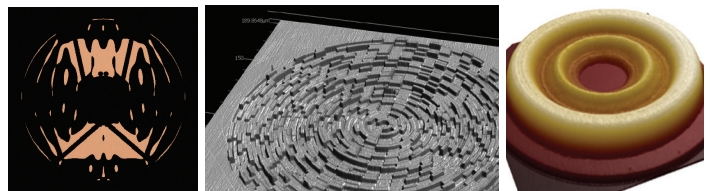

Pupil-plane reflective mask for the SPC, 24-mm diameter, black silicon on mirror (left). Image-plane reflective mask for the back-up technology Phase Induced Amplitude Apodization Complex Mask Coronagraph (PIAA-CMC) coronagraph, 155- μ m diameter, raised elements on silicon (center). Image-plane transmitting mask for HLC, 100- μ m diameter, raised dielectric and metal on glass (right). All masks were fabricated in the Micro-Devices Lab (MDL) at the Jet Propulsion Laboratory (JPL).

Impact: With achievement of these milestones, NASA is a major step closer to being confident that WFIRST will be able to directly image planets and dust disks around nearby stars. There are at least 15 radial-velocity exoplanets that both coronagraphs will be able to image in their dark hole regions, in a few hours integration time each. The WFIRST coronagraph will enable scientists to see these exoplanets directly for the first time, and the images will be in their true colors (using some of the other color filters in the CGI). A simulation is shown in the figure on page 7, where the blocked star is hidden inside the annulus; a planet is seen at about 5 o'clock, and the star is assumed to have no zodiacal dust around it (left) or a strong dust cloud (right).

Status and Future Plans: WFIRST successfully completed its Mission Concept Review in December 2015, in preparation for its Phase-A start the following January (which was also successful). The CGI is baselined as a technology demonstration instrument on WFIRST; it does

not drive mission requirements beyond those needed for the Wide Field Instrument. However, with one year of allocated observing time out of a six-year mission, NASA expects that it will achieve breakthrough science, and will demonstrate key technology elements for follow-up missions, the next of which could be aimed at finding habitable Earth-like planets around nearby stars.

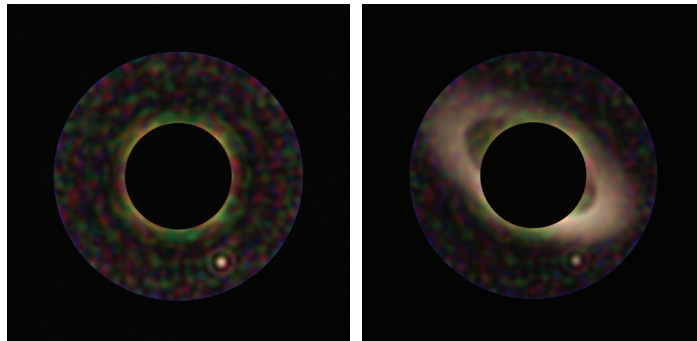

Simulation of expected image with CGI on WFIRST of a planet (at about 5 o'clock) with no zodiacal dust cloud (left) and with a zodiacal dust cloud (right).

Sponsoring Organization: This coronagraph technology is jointly funded by the Astrophysics Division's SAT program, in partnership with the NASA Space Technology Mission Directorate (STMD). NASA JPL currently leads the coronagraph development effort, and key contributions of the coronagraph team have been provided by three former SAT PIs: Jeremy Kasdin at Princeton University, John Trauger at NASA JPL, and Olivier Guyon at the University of Arizona.

SPECIALIZED WEAVING TECHNIQUES ENABLE A NEW HEAT SHIELD FOR PLANETARY EXPLORATION

Technology Development: When the Galileo mission's probe entered the Jovian atmosphere in December 1995, it experienced temperatures twice as hot as the surface of the sun, and required carbon phenolic shields to protect its onboard payload from the intense heat. Since that mission, NASA has not flown a spacecraft that required protection from such extreme heat. Recently, however, the NRC Planetary Science Decadal Survey has recommended that NASA consider in situ science missions to Venus and Saturn as a high priority in the New Frontiers competed mission set. To reach the surface of these planets, missions will require heat shields that are capable of withstanding very extreme entry environments, but are not as heavy as the previously used carbon phenolic heat

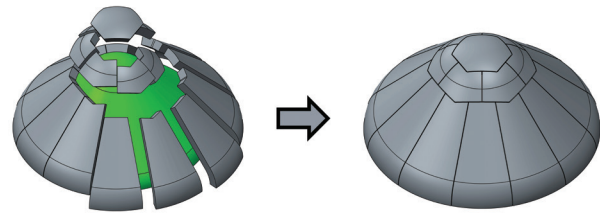

A drawing of the individual components that make up a heat shield (left) and the fully assembled heat shield with integrated seams bonded to the structure underneath (right).

shields. To respond to this need, NASA and its industry partners are developing an innovative way to design and manufacture a family of ablative thermal protection system (TPS) materials using commercially available weaving technology. This new approach—called Heat-shield for Extreme Entry Environment Technology (HEEET)—leverages the way three-dimensional (3-D) weaving is used to manufacture aircraft parts made of carbon composite materials. To manufacture TPS materials with the desired properties, fibers of different compositions and variable yarn densities are accurately placed in a 3-D structure. Three-dimensional weaving extends the traditional two-dimensional (2-D) weaving by interconnecting woven material in the third direction, enabling the manufacturing of materials that are more robust to the entry environment than traditional 2-D woven materials. The panels are then infused with resins and cured to lock the fibers in place. Using advanced modeling, design, and manufacturing tools to optimize the weave for overall improved performance, the HEEET project has manufactured a new family of TPS materials and tested them for a wide variety of entry conditions.

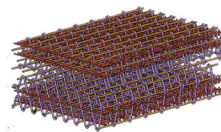

A multi-layer weave schematic showing high-density top and bottom layers with a mid-density layer with different yarn composition.

Impact: Depending on the mission design, peak heat-flux during entry can reach about 10,000 W/cm² for both Venus and Saturn, and the peak pressure can range up to about 1,000 kPa. HEEET is currently being designed to withstand these conditions and at the same time provide mass efficiency far superior to that of the heritage carbon phenolic material used for TPS in legacy missions. In addition to providing thermal protection, the 3-D weave also increases the mechanical robustness of the TPS material.

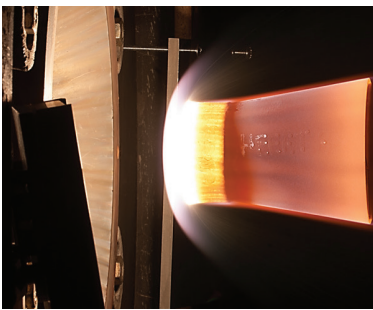

Testing of HEEET material at the NASA Ames Arc Jet Complex in the Interaction Heating Facility.

Status and Future

Plans: The HEEET team is currently supporting multiple New Frontier proposals in anticipation of a New Frontiers Announcement of Opportunity at the end of 2016. Plans call for the HEEET project to mature and deliver technology

for infusion into selected missions long before Key Decision Point B—the decision gate leading to the period in the mission life cycle where a project begins preliminary design and completes required technology development. In 2015, HEEET milestones included demonstration of the ability to form and resin-infuse a representative acreage HEEET tile, the spherical nose cap. In addition, the project successfully completed an arc jet test series to support material response model development and in support of the seam design. This testing allowed the project to refine its material response model in support of TPS sizing and to narrow the seam design trade space.

Sponsoring Organization: SMD funding of HEEET began in 2013, when the Planetary Science Division (PSD) jointly funded a year-long formulation study with the Space Technology Mission Directorate's Game Changing Development (GCD) Program. In fiscal year (FY) 14, the HEEET project was formally funded jointly by SMD and STMD, as a four-year effort to further mature technology for advanced TPS. NASA's industry partners include Bally Ribbon Mills in Bally, Pennsylvania and Fiber Materials Inc. in Biddeford, Maine.

TEST FLIGHTS DEMONSTRATE NEW CONCEPT FOR OCEAN COLOR RETRIEVAL

Technology Development: The Multi-Slit Optimized Spectrometer (MOS) prototype instrument is an airborne sensor designed to demonstrate and validate the multi-slit concept for hyperspectral ocean color retrievals with real-world scenes. The instrument design represents a new option for hyperspectral sensing: MOS multiplexes a scene by imaging from four slits at the same time. This method allows the MOS sensor to cover the field of regard four times faster than a single slit spectrometer, while achieving the same signal-to-noise ratio. This new technology enables faster revisit times compared to

traditional spectrometer concepts—all with an instrument that is smaller and 3-4 times lighter than previous sensors. The technology used to develop MOS could dramatically reduce payload size and mission risk for a geostationary mission.

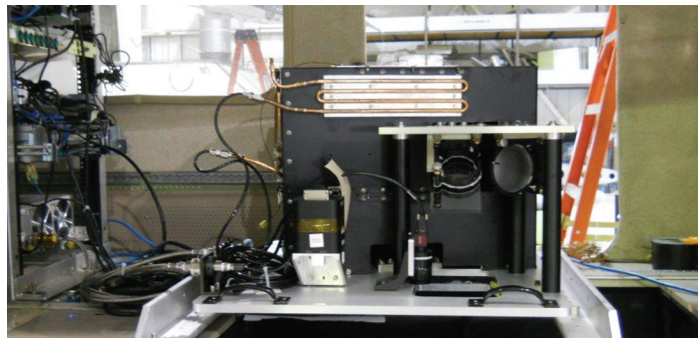

The MOS instrument installed in the Twin Otter aircraft. (Credit: Tim Valle, Ball Aerospace)

Impact: MOS was designed and developed to provide a small coastal imaging spectrometer that would meet the projected measurement requirements of the NASA GEOstationary Coastal and Air Pollution Events (GEO-CAPE) mission concept. One objective of GEO-CAPE is to help scientists discern the dynamics of coastal ecosystems, river plumes, and tidal fronts. Coastal regions experience numerous effects from human activities—materials enter the ocean from the land and atmosphere, and a disproportionate amount of the world's seafood is harvested from the coastal ocean regions. Technologies developed for MOS will enable a GEO-CAPE sensor that can accurately and quickly image these important coastal regions to help scientists understand and model the way these regions respond to phenomena such as storms, harmful algal blooms, hazardous spills, and flooding.

Status and Future Plans: MOS conducted a series of engineering flight tests in October 2014 onboard a Twin Otter aircraft. The flights, totaling up to 26 hours, were conducted over Lake Tahoe and the Sacramento and San Joaquin rivers and included some over-flights of in situ (boat-based) water quality measurements. Work on MOS concluded in August 2015, following extensive data analysis. Looking forward, the MOS project team hopes to add a polarimeter to the system to demonstrate simultaneous characterization of aerosols above coastal scenes.

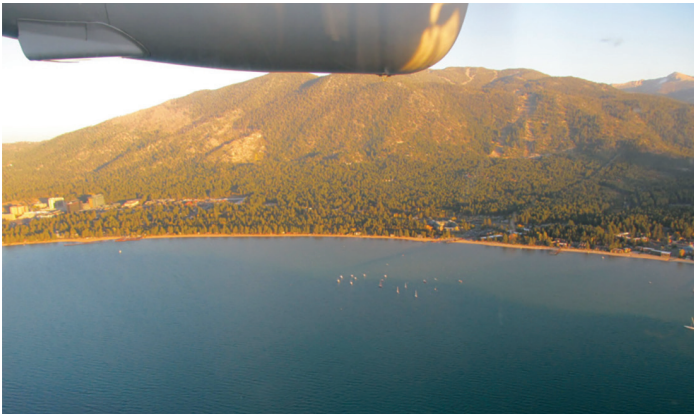

An airborne view of Lake Tahoe during an MOS test flight.

Sponsoring Organization: The Earth Science Division sponsored development of MOS via the IIP. PI Tim Valle of Ball Aerospace and Technologies Corp. led the MOS development effort.

NEW ATMOSPHERIC DETECTOR TECHNOLOGY DEMONSTRATED ON A CUBESAT

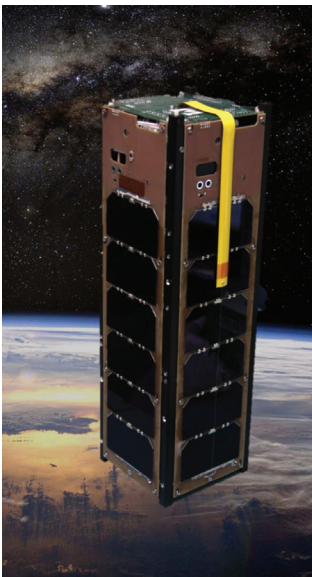

An artist's depiction of GRIFEX in orbit.

Technology Development: The GEO-CAPE ROIC In-Flight Performance Experiment (GRIFEX) CubeSat was launched from Vandenberg Air Force Base on Saturday, January 31, 2015, as an auxiliary payload to the Soil Moisture Active Passive (SMAP) mission. GRIFEX is a 3-unit (3U, 10x10x30 cm) CubeSat designed to verify the performance of a new spaceborne technology to study conditions in Earth's atmosphere. GRIFEX includes

a state-of-the-art readout integrated circuit (ROIC)/Focal Plane Array (FPA) with in-pixel digitization and an unprecedented frame rate of 16 kHz. Intended for future imaging interferometry instruments and missions, the technology specifically targets the requirements of the GEOstationary Coastal and Air Pollution Events (GEO-CAPE) mission. GEO-CAPE was recommended by the NRC's Earth Science Decadal Survey to investigate the physical, chemical, and dynamical processes that determine the composition and air quality of Earth's troposphere. GRIFEX was released into space by a

Poly-PicoSatellite Orbital Deployer (P-POD) mounted on the upper stage of the Delta II rocket about 107 minutes after launch. Amateur radio collaborators in Europe were the first to detect the GRIFEX signal beacon about two hours after release. GRIFEX was put into an approximately 650 km circular, polar, low Earth orbit with a 95-minute orbit period.

Impact: The GRIFEX project has fully demonstrated a key technology that will enable hourly, high-resolution spatial and spectral measurements of rapidly changing atmospheric chemistry and pollution transport from a geostationary orbit. The ROIC will enable development of all-digital FPAs capable of the high-speed imaging needed to observe the rapidly evolving conditions in the troposphere. This capability is relevant to the study of climate change, as well as for future missions such as GEO-CAPE that require advanced detectors.

Status and Future Plans: The GRIFEX team reported complete, successful demonstration of the GRIFEX ROIC/detector in the space environment within the first six months of operation. As of this report, the spacecraft is still healthy and operational and is expected to continue sending data for many months to come.

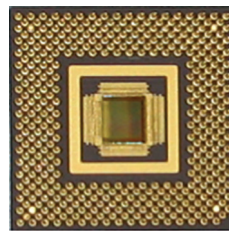

The GRIFEX ROIC focal plane array. (Image credit: D. Rider, JPL/Caltech)

Sponsoring Organization: The Earth Science Division provided funding to develop the ROIC technology used on GRIFEX via a 2008 ESTO ACT program investment. David Rider at the NASA Jet Propulsion Laboratory and James Cutler at the University of Michigan currently lead the GRIFEX team.

LABORATORY TECHNOLOGY HELPS UNLOCK THE MYSTERIES OF MAGNETIC RECONNECTION

Technology Development: Technological progress in recent years has significantly increased the ability to generate, control, and diagnose plasmas in the laboratory, allowing researchers to reliably reproduce important processes widely observed in space. The Magnetic Reconnection Experiment (MRX) is enabling scientists to understand several of these important phenomena, including the magnetic reconnection process and the behavior of solar magnetic loops—known as flux ropes.

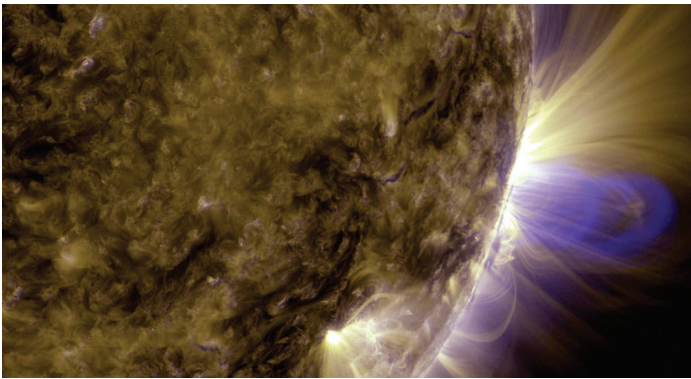

Image of magnetic loops (flux ropes) on the sun, captured by NASA's Solar Dynamics Observatory (SDO).

The magnetic reconnection process efficiently converts magnetic energy to plasma particle energy through topological changes in the magnetic field. MRX allows researchers to generate the process of magnetic reconnection in a controlled manner by pulsing electric currents in coils inside a vacuum chamber. The time evolution of magnetic field vectors and plasma parameters are measured in the MRX chamber at a large number (typically several hundreds) of locations. These measurements have enabled scientists to characterize several aspects of the magnetic reconnection process, including the accurate determination of current sheet structures, the reconnection rate, waves and turbulence, and the energy conversion process. To study the eruption of magnetic loops, researchers use MRX to generate magnetic flux ropes between electrodes in a modified coil setup. By slowly injecting a sufficiently large magnetic free energy, the flux ropes can rapidly erupt via a large-scale instability. Both point-like and large-scale measurements of the flux ropes and associated phenomena generated in MRX enable researchers to characterize the behavior of flux ropes over a wide range of parameters.

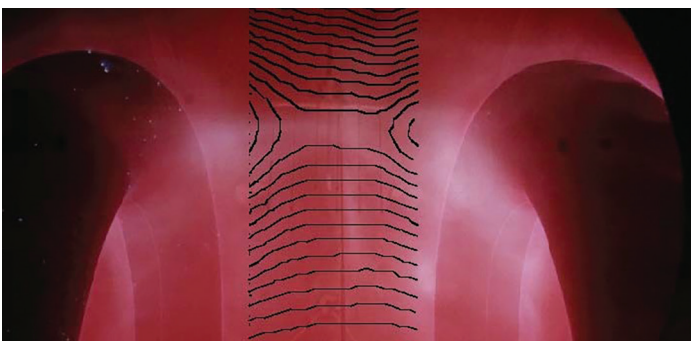
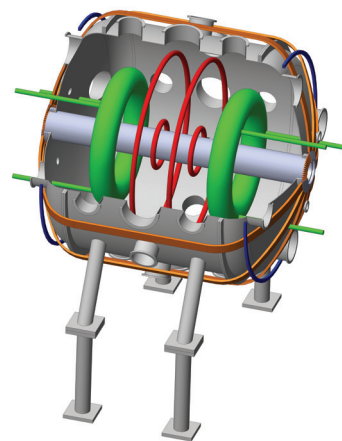

Photo of a hydrogen plasma where magnetic reconnection is generated in MRX by two coils (blackened objects on the left and right), superimposed by reconnecting magnetic field lines measured by in situ diagnostics.

Impact: Magnetic reconnection underlies most of the explosive phenomena observed in heliophysics, including solar flares, coronal mass ejections (CME), solar wind interaction with planetary magnetospheres, magnetic disturbances observed in Earth's magnetosphere, and particle energization in the outer heliosphere. Reconnection also plays a key role in many astrophysical phenomena ranging from star formation to accretion onto supermassive black holes. However, many critical questions, such as why reconnection always occurs impulsively fast and what are conditions for CMEs to initiate, remain unanswered despite decades of active research. Use of laboratory experiments in conjunction with satellite observations and numerical modeling has enabled breakthroughs in understanding. MRX measurements have confirmed and validated the interpretation of results from the Polar and Cluster satellites, whose observations were necessarily limited to a few spatial points. Measurements from MRX will also enable researchers to use data from the new Magnetospheric Multiscale (MMS) mission to identify the predicted electron diffusion regions wherein field lines actually reconnect. The in situ magnetic field measurements from the MRX flux rope experiment demonstrated a promising way to understand the initiation mechanisms of CMEs and enhance space weather research.



The FLARE device, currently under construction.

Status and Future Plans:

NASA will leverage investments in physics laboratory technology like MRX not only to understand the science from its current missions, but to guide the science targeted in future missions. Technology advances from MRX will also contribute to the next-generation Facility for Laboratory Reconnection Experiments

(FLARE) device, scheduled for operation in 2017. FLARE is being proposed as a user facility for collaborative research on magnetic reconnection and related explosive phenomena.

Sponsoring Organization: The Heliophysics Division's H-TIDeS program contributed funding to research on MRX, which was conducted at Princeton University by PI, Dr. Hantao Ji.

FIRST FLIGHTS FOR CO₂-DETECTING LIDAR

Technology Development: Nearly two decades of NASA technology investment in lidar systems and two-micron transmitters has resulted in a new capability for remotely measuring the carbon dioxide (CO₂) levels in Earth's atmosphere. NASA has developed an Integrated Path Differential Absorption (IPDA) Lidar that incorporates high-energy, double-pulse lasers with high repetition rates. The compact lidar instrument aims to provide accurate, high-resolution atmospheric CO₂ column measurements from an airborne platform. The laser pulses can be tuned and locked near the 2.05 micron wavelength, an ideal spectral region for CO₂ sensing. Separated by 150 microseconds, the first pulse is tuned to a high CO₂ absorption wavelength and the second pulse to a low absorption wavelength. By aiming the pulses at a hard target, or Earth, the difference between the return signals correlates to the average amount of CO₂ in the column between the instrument and the target.

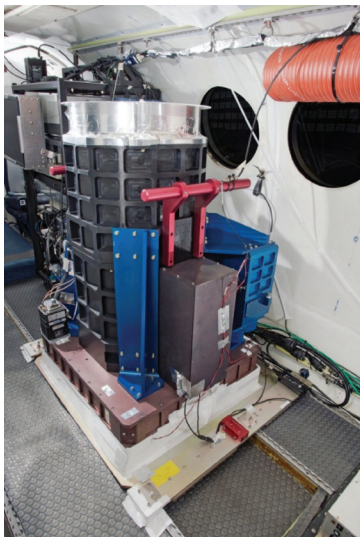

The 2 micron IPDA lidar system installed in the NASA B200. (Image credit: Upendra Singh)

Impact: Carbon dioxide is a greenhouse gas that is considered an important contributor to global warming. Currently, satellites monitoring Earth's CO₂ levels employ passive sensing instruments. An active sensing system like the IPDA Lidar has the potential to overcome some of the limitations of passive systems to provide the accuracy required to more definitively resolve the CO₂

profile. The IPDA Lidar is intended to be a stepping-stone toward an eventual spaceborne mission for active remote sensing of CO₂, such as the ASCENDS (Active Sensing of CO₂ Emissions over Nights, Days, and Seasons) mission concept. Recommended by the National Research Council in its 2007 decadal survey, ASCENDS is intended to

facilitate a greater understanding of the role CO₂ plays in the global carbon cycle. The newly developed IPDA Lidar technology has the potential to provide satellite-based CO₂ measurements that will deliver accurate CO₂ measurements all day and night, year-round, at all latitudes. These data will help identify human-generated CO₂ sources and sinks, improve climate models and climate predictions, and enable a better understanding of the connection between climate and CO₂ exchange.

Status and Future Plans: Over 11 days in March 2015, the pulsed 2-micron direct detection IPDA Lidar completed 10 engineering flights, totaling about 27 hours, over Virginia onboard the NASA B200 King Air aircraft. The test flights occurred over diverse terrain with varying reflectivity, and analysis shows the measured optical depth for column length matched the modeled value within a few percent. Results from the tests are positive and the instrument has likely performed the first proof-of-principle demonstration of an airborne, direct-detection, two-micron CO₂ measurement. Currently, the project team is working to incorporate a third transmitted pulse into the system. A triple-pulsed system would enable simultaneous CO₂ and water vapor (H₂O) measurements in a single compact instrument.

Sponsoring Organization: The Earth Science Division provided funding to develop the IPDA Lidar to PI Upendra Singh at Langley Research Center via the IIP and ACT programs.

SOUNDING ROCKET MISSION DEMONSTRATES NEW TECHNOLOGY TO MEASURE MAGNETIC FIELDS IN A CRITICAL REGION OF THE SUN'S ATMOSPHERE

Technology Development: Remote sensing of magnetic fields requires both precision spectroscopy and precision polarimetry (spectro-polarimetry). NASA led an international team that developed the Chromospheric Lyman-Alpha Spectropolarimeter (CLASP)—the first instrument to achieve the spectro-polarimetry needed for magnetic field measurements of the outer layers of the solar atmosphere. Previous solar magnetic field measurements were restricted to regions near the sun's surface because adequate spectro-polarimetry has been (until now) technically feasible only in visible and near-infrared light. In these regions, the forces associated with gas pressure dominate the forces associated with



The international experiment team attending the launch of the CLASP instrument (inside white box) mounted on the launch rail.

magnetic fields. However, in the outer solar atmosphere (the transition region and corona) the magnetic fields dominate. Numerical extrapolation to determine magnetic fields in the outer layers of the solar atmosphere (where magnetic pressure dominates) from observations of fields in the photosphere (where gas pressure dominates) is not sufficiently accurate to understand and predict key physical processes. CLASP provided the first measurement of the scattering polarization of light in the Lyman-alpha spectral line, Ultra-Violet light that is formed in the upper chromosphere and transition region of the sun. This polarization is modified by the local

magnetic field; hence CLASP's detection of this polarization is a powerful tool for measuring the magnetic field in the upper chromosphere. The modification of the linear polarization in the Lyman-alpha spectral line is small, only on the order of 0.5%. Measurement of this small change in polarization requires a well calibrated instrument, maintenance of stable pointing during the observations, as well as low-noise cameras. The NASA CLASP team developed the low-noise CLASP camera system and an accompanying flexible avionics package that can be modified to accommodate other suborbital missions.

Impact: Space weather—the dynamic electrical and magnetic conditions in the Earth's outer space environment—can greatly affect human endeavors, disrupting electric power grids on Earth, interfering with high-frequency radio communications and Global Positioning System (GPS) navigation systems, and damaging Earth-orbiting spacecraft. Most of the solar variability and solar eruptions affecting space weather originate in the sun's outer atmosphere regions. Therefore, to understand space weather it is critical to achieve direct

measurements of the dominant force in these regions—the magnetic fields. By achieving ultraviolet spectro-polarimetry in the transition region and corona, CLASP has shown how to achieve direct magnetic field measurements that will enable scientists to understand solar processes that affect life on Earth.

Status and Future Plans: CLASP launched from White Sands Missile Range aboard a NASA Sounding Rocket Program Black Brant IX vehicle on September 3, 2015. The flight attitude control system proved very stable during the period of observations, with less than 0.1" jitter and 1" drift over the five minutes of data accumulation. The NASA-developed camera system achieved a six-electron root mean square (RMS) noise during flight. The initial data indicate that CLASP detected scattering polarization in Lyman-alpha. Interpretation of these polarization modulation observations in terms of the solar magnetic field and the implications for the theory of structures in the solar atmosphere is being prepared for publication in a peer-reviewed journal. Accomplishment of these challenging measurements provides a path to routinely obtaining magnetic field measurements of the solar atmosphere from a future orbital platform.

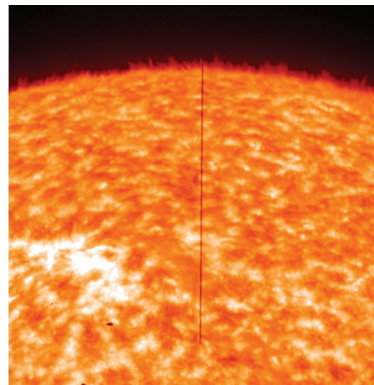

The quiet sun region observed by CLASP. This image is taken with the NASA-developed slitjaw camera with a broad band filter centered on the Lyman alpha spectral line. The black line in the image is the slit.

Sponsoring Organization: The CLASP instrument is a partnership between NASA; the Japan Aerospace Exploration Agency (JAXA); the National Astronomical Observatory of Japan (NAOJ); the Instituto de Astrofísica de Canarias in Santa Cruz de Tenerife, Spain (IAC); and the Institut d'Astrophysique Spatiale

in Paris (IAS). The optical instrument was developed, built and calibrated by NAOJ. The Heliophysics Division's H-TiDeS low-cost access to space (LCAS) program provided funding for NASA's contribution to CLASP, which was developed by PI, Dr. Amy Winebarger, at Marshall Space Flight Center (MSFC).

AUTO-GOPHER: DRILLING DEEP TO EXPLORE THE SOLAR SYSTEM



An initial version of the drill technology—the Auto-Gopher-1—is pictured here with cores it acquired from drilling a 3-m hole in 40 MPa gypsum.

It incorporates a wireline architecture; the drill is suspended at the end of a small diameter tether that provides power, communication, as well as structural support needed for lowering and lifting the drill out of the borehole. Thanks to this unique architecture, the maximum drilling depth is limited only by the length of the tether. The wireline operation used on the Auto-Gopher removes one of the major drawbacks of traditional continuous drill string systems—the need for multiple drill sections that can add significantly to the mass and the complexity of a deep drill. As such, the Auto-Gopher system mass and volume can be kept quite low for shallow or deep holes. While drilling, numerous sensors and embedded instruments can perform in situ analysis of the borehole wall. Upon reaching a preset depth, the drill is retracted from the borehole, the core and/or cuttings are removed for detailed analysis by onboard instruments, and the drill is lowered back into the hole to continue the penetration process.

Impact: The Auto-Gopher is intended to help scientists answer one of the most pressing questions in science: Has life ever existed anywhere else in the universe? Since water is a critical prerequisite for life, as we know it, NASA exploration missions are targeting bodies in the solar system that are known to have or have had flowing liquid water. The latest Planetary Decadal Survey (Vision and Voyages for Planetary Science in the Decade 2013-2022)

Technology Development:

The ability to penetrate subsurfaces and collect pristine samples from depths of tens of meters to kilometers is critical for future exploration of bodies in our solar system. SMD is supporting development of a deep-drill sampler called the Auto-Gopher for potential deployment in future space exploration missions. The Auto-Gopher employs a piezoelectric actuated percussive mechanism for breaking formations and an electric motor to rotate the drill bit and capture powdered

recommended that NASA explore three solar system bodies with accessible aqueous regions: Mars; Jupiter's moon, Europa; and Saturn's moon, Enceladus. Each of these bodies poses different drilling-related challenges. Drilling on Mars requires penetrating dry rock and regolith that have physical properties (i.e., tensile strength, hardness, etc.) that can vary many orders of magnitude though the drill depth. A drill on Enceladus and Europa will need to operate in ice at temperatures below 100 K, while accounting for the low gravity on Enceladus or the high surface radiation on Europa. The Auto-Gopher must be designed to achieve its goals of penetrating the subsurface to great depths, capturing pristine samples, and delivering those samples to onboard instruments for analysis or for potential sample return—all in the harsh conditions encountered in space.

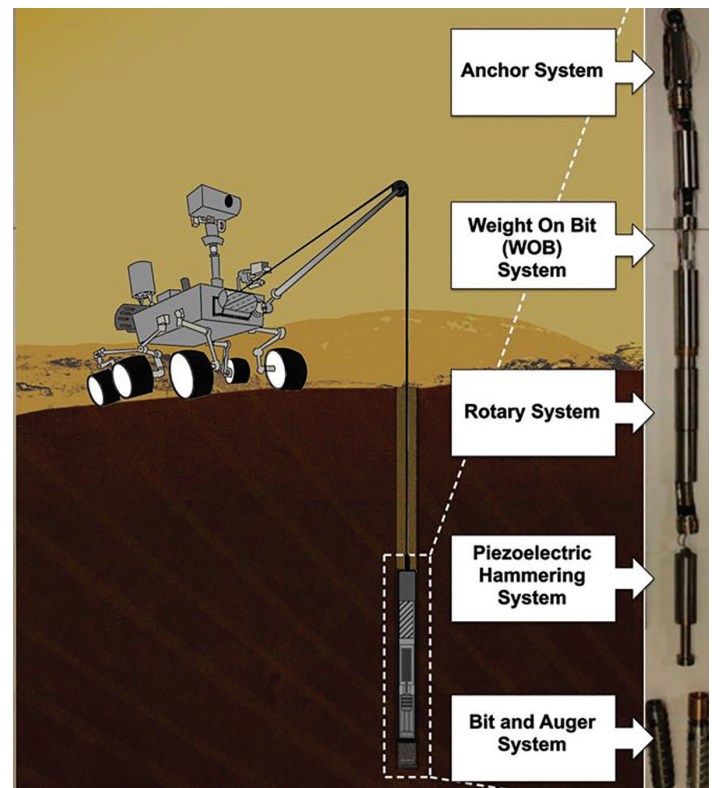

Illustration of the Auto-Gopher concept as a wireline deep drill.

Status and Future Plans: The aim of the Auto-Gopher development effort is to demonstrate a scalable technology that makes deep drilling possible using current launch vehicles and power sources. This technology development has been accomplished in several generations including the Ultrasonic/Sonic Driller/Corer, Ultrasonic/Sonic Gopher, and the Auto-Gopher-1. In 2015, PSD awarded a project under its MatISSE program to support the next generation of Auto-Gopher technology

development—the Auto-Gopher-2. In 2015, the project produced a core breaker and retaining mechanism and demonstrated their operation. This latest drill is also being designed to house electronics, sensors, and mechanisms needed for autonomous drilling, and the critical subsystems are currently being breadboarded and tested. Future planned activities include field trials to validate drill operation in harsh conditions at a U.S. gypsum quarry (gypsum can change from hard crystalline gypsum, to soft sugar gypsum, to very hard anhydrite with numerous clay-rich veins) and inside a vacuum chamber, drilling in ice at approximately -100°C.

Sponsoring Organization: The research, led by PI Kris Zacny of Honeybee Robotics, is funded by the PSD's MatISSE program, and jointly developed with the Jet Propulsion Laboratory (JPL)/California Institute of Technology.

RADIAL CORE HEAT SPREADER TO IMPROVE STIRLING RADIOISOTOPE GENERATOR HEAT REJECTION

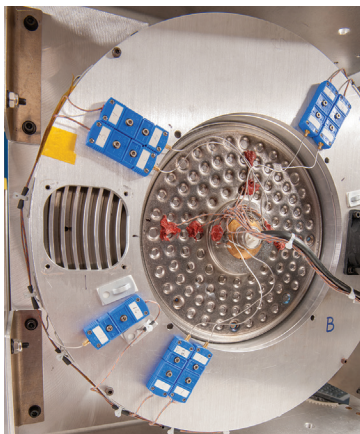

The Radial Core Heat Spreader shown mounted inside the experiment heat exchanger during preparations for the suborbital flight test.

Technology

Development: The NASA Glenn Research Center is developing the next generation of Stirling Radioisotope Generators (SRGs) to power deep space science missions. One potential technology gap is the waste heat rejection approach for higher power Stirling converters. The previous 140W Advanced Stirling Radioisotope Generator (ASRG) used a copper

alloy conduction flange to transfer heat from the convertor to the generator housing radiator surface. The conduction flange would incur a substantial mass and thermal performance penalty for larger Stirling systems. The Radial Core Heat Spreader (RCHS) is a passive two-phase thermal management device developed to solve this issue by using water vapor instead of copper as the heat transport media.

The RCHS is a hollow, dimpled titanium disc that uses boiling and condensing water to transfer heat radially from the center where the Stirling convertor would be located, to the outer diameter where the generator housing would attach. The experimental RCHS weighs about 175 grams and is designed to transfer 130 W (thermal) from the hub to the perimeter. It operates at a nominal temperature of 90°C with a usable range between 50 and 150°C. For testing, the Stirling convertor was replaced by an electrical heating element and the generator housing was replaced with a heat absorber.



Black Brant IX Vehicle

Two parabolic flight campaigns and one suborbital flight test provided essential data in multiple gravity environments to evaluate the thermal performance of the RCHS. The parabolic flights took place during 2013 and 2014. The suborbital flight took place on July 7, 2015 and included two RCHS

units, one parallel and one perpendicular relative to the launch vector. The Black Brant IX rocket delivered the RCHS payload to an altitude of 332 km with over eight minutes of microgravity. The purpose of this experiment was to determine if the RCHS could function during all mission phases. Since SRGs are fueled and operating prior to launch, it is crucial that proper thermal management be maintained during 1-g ground handling, hyper-g launch, and micro-g space environments. Test results verified that the RCHS could tolerate the gravitational transients throughout the suborbital flight, while transferring the thermal power necessary to keep a Stirling convertor within its prescribed temperature limits.

Impact: The flight-tested RCHS is one-fourth the mass of the state-of-the-art ASRG copper conduction flange, and provides enhanced heat transfer to minimize thermal resistance. As the Stirling convertor's power level increases, the mass savings and heat transport benefits provided by the RCHS will increase substantially. The sounding rocket flight test proved that the RCHS could maintain proper thermal control during hypergravity and microgravity regardless of the orientation of the device relative to the launch forces.

Status and Future Plans: The RCHS has reached a Technology Readiness Level (TRL) of six for use in Stirling power systems through rigorous testing in a wide range of environments including launch, microgravity, and thermal-vacuum. If the technology were adopted in the next generation SRG, additional integrated system testing would be required.

Sponsoring Organization: PSD's Radioisotope Power Systems Program sponsored the RCHS development by providing funding to PI Marc Gibson at NASA Glenn Research Center. The STMD Flight Opportunities Program provided flight vehicles in partnership with the Reduced Gravity Office (RGO) from the Johnson Space Center (JSC) and NASA's Sounding Rocket Program (NSRP) from the Goddard Space Flight Center (GSFC) and Wallops Flight Facility (WFF).

NASA INVESTIGATES A BACKUP COOLING DEVICE FOR STIRLING RADIOISOTOPE POWER SYSTEMS

Technology Development: NASA is sponsoring development of an alkali-metal Variable Conductance Heat Pipe (VCHP) to serve as a heat source backup cooling device for Stirling Radioisotope Power Systems (RPS). RPS are critical to planetary missions because they produce electricity and heat for long periods under the harsh conditions of deep space. In these systems, heat must be continuously removed from the plutonium-238 General Purpose Heat Source (GPHS) modules to maintain the modules and surrounding insulation at acceptable temperatures. Past Stirling RPS prevented damage to the GPHS during an extended loss of cooling by spoiling the insulation allowing the heat to escape—at the cost of early termination of the system. In a Stirling RPS, an operating Stirling convertor provides the necessary cooling as the GPHS heat is converted to electricity. However, there are mission scenarios where it might be desirable to stop Stirling convertor operation. The VCHP is designed to passively activate with a small increase in temperature and redirect heat from the GPHS to a secondary heat rejection sink when the Stirling convertor is stopped. In April 2015, a prototype VCHP developed by Advanced Cooling Technologies, Inc. through a Small Business Innovation Research (SBIR) effort was successfully integrated with a Stirling convertor and tested at NASA's Glenn Research Center (GRC). During this test, the prototype VCHP demonstrated its ability to passively maintain temperatures

under constant thermal heat input after the Stirling convertor was stopped for 90 minutes (long enough to reach steady-state temperatures). Additionally, the VCHP reliably and repeatedly activated through three convertor start/stop cycles.

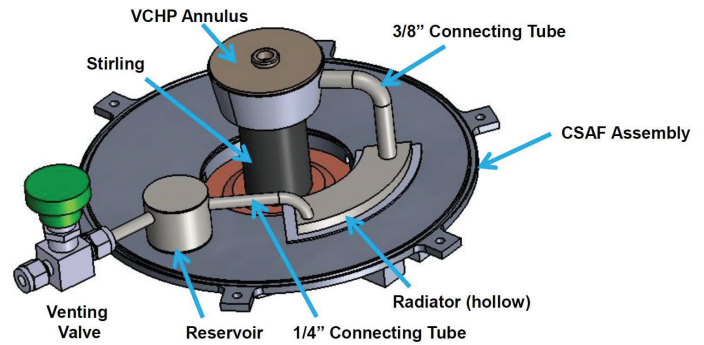

Diagram of a Variable Conductance Heat Pipe prototype designed by Advance Cooling Technologies, Inc. integrated with a free-piston Stirling convertor designed by Sunpower, Inc. for test at NASA Glenn Research Center.

Impact: The VCHP enables the ability to repeatedly stop and restart Stirling convertor operation without risk of terminating the mission. This feature could be beneficial during installation of the GPHS modules into the Stirling system, and during spacecraft integration and launch operations. Also, this feature improves mission flexibility by enabling use of Stirling RPS for missions where scientific measurements require minimal electromagnetic interference and vibration, which is achieved by temporarily stopping convertor operation. The device could also allow the system to recover from a temporary Stirling convertor or electrical controller fault.

Status and Future Plans: The particular VCHP prototype tested at GRC in April 2015 would raise the mass of a Stirling RPS by ~0.4 kg and increase the thermal loss by ~5 W. Plans for future development may include use of improved materials for reduction of weight and thermal losses, demonstration of system level operation in vacuum, and demonstration under launch level vibration.

Sponsoring Organization: The Stirling VCHP backup cooling device was designed and fabricated under a Phase III SBIR contract with funding from the PSD's Radioisotope Power Systems Program's Stirling Cycle Technology Development Project. The PI for this project is Dr. Calin Tarau from Advanced Cooling Technologies, Inc. PSD is investigating Stirling RPS as a high-efficiency alternative to Radioisotope Thermoelectric Generators.

MEASURING SNOW TO MANAGE WATER RESOURCES



The WISM instrument being integrated into the Twin Otter Aircraft.

Technology

Development: The Wideband (8-40 GHz) Instrument for Snow Measurement (WISM) is designed to accurately measure snowpack on

the ground from an airborne platform. WISM is comprised of a dual-frequency (X- and Ku-bands) Synthetic Aperture Radar (SAR) and a dual-frequency (K- and Ka-bands) radiometer. Instead of using individual antenna feeds for each frequency, WISM employs a broadband current sheet array (CSA) antenna feed that enables the integration of the radar and radiometer using a single antenna aperture. Use of this new technology is expected to achieve improved snow measurements, along with significant size, weight, and power advantages over previous systems.

Impact: Seasonal snowpack supplies 50% to 80% of the yearly water supply in the Western United States. To effectively manage water resources, frequent and accurate measurements of the amount of water in the snowpack—the snow water equivalent (SWE)—are critical to understand the very small spatial scales over which the snowpack varies. Eventually, the wideband antenna/instrument technology demonstrated successfully by WISM could be used in spaceflight applications to provide improved measurements of SWE.



The Twin Otter carrying WISM gets a final checkout on the first day of flights.

Status and Future Plans: In late February 2015, WISM was installed on a Twin Otter aircraft for a series of demonstration flights over snow-covered areas of Colorado. In 9.4 hours of total flight time, the WISM team collected high-resolution snow data over a broad range of snowpack conditions near Grand Junction, CO, particularly over an experiment site on Grand Mesa. To validate the WISM retrievals, extensive in situ snowpack profiles were also taken using high-resolution ground-based radar and ancillary airborne lidar measurements. These ground observations included 19 detailed snow pits (to determine snow density, temperature, grain size, grain type, and layer thickness profiles), 8,000+ manual depth measurements, and measurements from two snowmobile-based radars that profiled the entire WISM flight line multiple times at 10-cm resolution. On this flight, WISM demonstrated wideband antenna performance, as well as near-simultaneous sensing with both the radar and radiometer.

Sponsoring Organization: The Earth Science Division provided funding for WISM to PI Tim Durham of Harris Corporation via the IIP.

TECHNOLOGY INFUSION

SEVEN SMD-SUPPORTED INSTRUMENTS TO SEARCH FOR EVIDENCE OF LIFE ON EUROPA

Technologies Infused: When NASA launches its mission to explore Jupiter's moon Europa in the 2020s, seven instruments enabled by SMD technology investments or flight development efforts will be onboard to help achieve mission science goals.

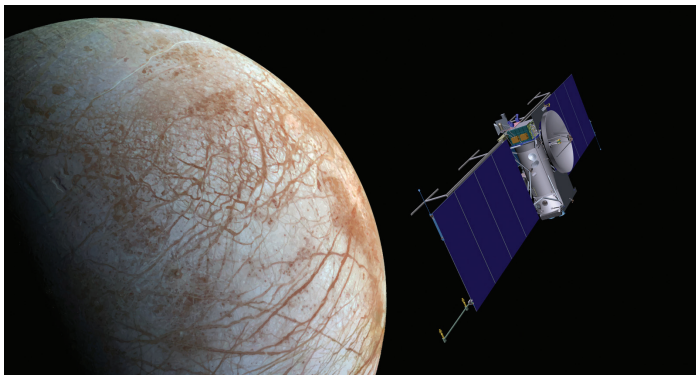

Artist's concept of NASA's Europa mission spacecraft approaching its target for one of many flybys. (Image credit: NASA/JPL-Caltech)

The Europa mission will gather high-resolution images of the moon's surface, and investigate the composition and structure of its interior and icy shell to determine if the moon might be habitable for primitive forms of life. Evidence from NASA's Galileo mission in the 1990s strongly suggested that Europa may contain a vast ocean underneath its icy crust. Europa also experiences great tidal forces as it orbits Jupiter, and these forces cause the moon to flex, which produces heat in the moon's interior. Scientists also believe that Europa's ocean is in direct contact with its rocky interior, creating conditions that could be similar to geologically active places on Earth's sea floor, called hydrothermal zones. Hydrothermal zones on Earth harbor large numbers of organisms that thrive

because of chemical processes that occur as water and rock interact at high temperatures. Europa's potential liquid water, combined with its heat-producing geological activity, make it one of the most promising places in the solar system to search for signs of present-day life. Seven of the instruments that NASA recently selected to fly on the Europa mission were enabled by SMD technology investments or previous planetary mission investments (see table on page 19). Two of those instruments—MASPEX and REASON—are detailed below.



Compiled from NASA's Galileo spacecraft data, this colorized surface image of Europa shows the blue-white terrains that indicate relatively pure water ice. Scientists are very interested in these features because they may offer a way to investigate the habitability of the moon's interior ocean. (Image credits: NASA/JPL-Caltech/SETI Institute)

MASPEX: The MAAss Spectrometer for Planetary EXploration/ Europa is a time-of-flight (TOF) mass spectrometer designed to determine the composition of Europa's surface and subsurface ocean by measuring the moon's extremely tenuous atmosphere and any surface material ejected into space. MASPEX

employs fast-switched dual reflectron ion optics to provide high-mass resolution in a half-meter long instrument. This new technology enables mass resolution several orders of magnitude greater than previous mass spectrometers flown on NASA missions. MASPEX is also highly sensitive. It can store over 100,000 ions and extract them at a rate of 2 Khz, providing a very high throughput and high time resolution. MASPEX's storage capability, coupled with an imbedded cryotrap that is more than 100,000 times more sensitive than previous instruments, allows the analysis of trace organics at levels less than one part per billion and

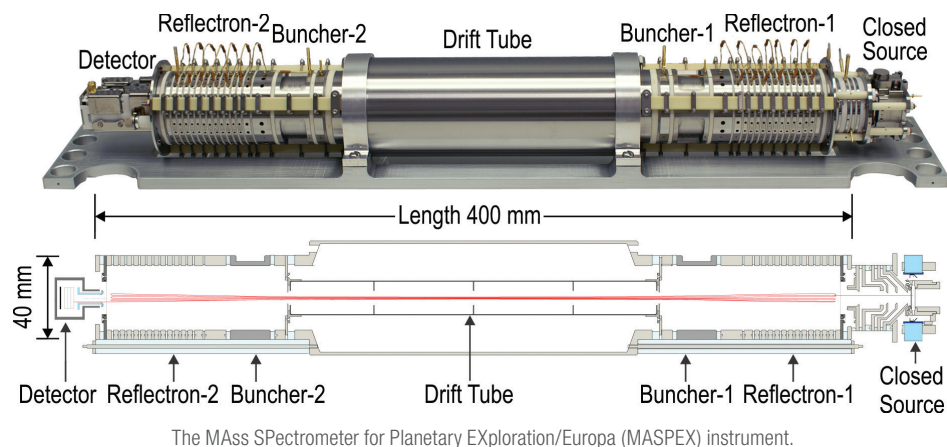

the isotopic analysis of trace noble gases like xenon. MASPEX provides a new and powerful tool for understanding the habitability, origin, and evolution of Europa.



Artist's concept of Europa's frozen surface. (Image credit: NASA/JPL-Caltech)

REASON: Radar for Europa Assessment and Sounding: Ocean to Near-surface (REASON) is a dual-frequency (9 MHz and 60 MHz) ice-penetrating radar instrument designed to characterize and sound Europa's icy crust from the near-surface to the ocean, revealing the hidden structure of Europa's ice shell and potential water within. REASON will also assess the near-surface structure and topography, as well as the state of Europa's ionosphere. The longer wavelength signal (9 MHz) can pass through Europa's ice with less interference from surface roughness. However, radio waves emitted by the planet Jupiter interfere with the signal, so it can be used only on the side of Europa facing away from the planet. The shorter wavelength signal (60 MHz), in contrast, is unaffected by Jupiter, but is more susceptible to interference from the roughness of Europa's ice. Together, the two signals will achieve comprehensive and clear images of Europa. REASON measurements will help scientists determine







the thickness of the moon's icy shell, search for evidence of water plumes, and characterize subsurface lakes and chemical exchange processes. Additionally, data from REASON will provide valuable information about potential landing sites and terrain for future missions that explore Europa's surface.

Impact: As part of the suite of science instruments on the Europa mission, MASPEX and REASON will enable scientists to learn more about the moon's composition, including whether an ocean exists underneath its icy surface, and whether there are conditions that could potentially harbor life. MASPEX will be most sensitive mass spectrometer ever flown in space, and will analyze the composition of gases found in Europa's atmosphere. REASON will characterize Europa's icy shell and the ocean that potentially lies beneath it. Other instruments onboard will detect emanating heat, measure the moon's magnetic field, and collect the most detailed images of Europa's surface ever obtained.

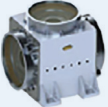
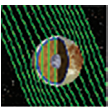
Status and Future Plans: The NASA Europa mission is now further developing MASPEX, REASON, and the other selected instruments to ensure they are flight-ready for launch in the early 2020s.

Sponsoring Organization: MASPEX development was funded jointly by the Southwest Research Institute and by NASA's PSD via the ICEE program. PSD funded technology development for REASON via the Planetary Instrument Definition and Development Program (PIDDP)—a technology program that existed prior to establishment of the PICASSO and MatISSE programs—and the ICEE Program. See table on page 19 for PSD funding sources and PI information for the PSD-sponsored instruments selected for infusion.

SMD-SUPPORTED TECHNOLOGIES SELECTED FOR THE EUROPA MISSION

INSTRUMENT NAME	DESCRIPTION (PI LISTED IN PARENTHESES)	PSD FUNDING SOURCE
 <p>Plasma Instrument for Magnetic Sounding (PIMS)</p>	<p>This instrument works in conjunction with a magnetometer (see below) and is key to determining the thickness of Europa's ice shell and the depth and salinity of the ocean by correcting the magnetic induction signal for plasma currents around Europa. (Dr. Joseph Westlake/Johns Hopkins Applied Physics Laboratory)</p>	<p>Instrument Concepts for Europa Exploration (ICEE) Program</p>
 <p>Interior Characterization of Europa using Magnetometry (ICEMAG)</p>	<p>This magnetometer will measure the magnetic field near Europa and—in conjunction with the PIMS instrument—infer the location, depth, and salinity of Europa's subsurface ocean using multi-frequency electromagnetic sounding. (Dr. Carol Raymond/NASA JPL)</p>	<p>ICEE Program</p>
 <p>Mapping Imaging Spectrometer for Europa (MISE)</p>	<p>This instrument will probe the composition of Europa, identifying and mapping the distributions of organics, salts, acid hydrates, water ice phases, and other materials to determine the habitability of Europa's ocean. (Dr. Diana Blaney/NASA JPL)</p>	<p>ICEE Program, MaTISSE</p>
 <p>Europa Imaging System (EIS)</p>	<p>The wide and narrow angle cameras on this instrument will map most of Europa at 50-meter resolution, and will provide images of targeted areas of Europa's surface at about one-meter resolution. (Dr. Elizabeth Turtle/Johns Hopkins University Applied Physics Laboratory [JHU/APL])</p>	<p>ICEE Program</p>
 <p>Radar for Europa Assessment and Sounding: Ocean to Near-surface (REASON)</p>	<p>This dual-frequency ice-penetrating radar instrument is designed to characterize and sound Europa's icy crust from the near-surface to the ocean, revealing the hidden structure of Europa's ice shell and potential water within. (Dr. Donald Blankenship/University of Texas, Austin)</p>	<p>Planetary Instrument Definition and Development Program (PIDDP) and ICEE Program</p>
 <p>MAss SPectrometer for Planetary EXploration/ Europa (MASPEX)</p>	<p>This instrument will determine the composition of the surface and subsurface ocean by measuring Europa's extremely tenuous atmosphere and any surface material ejected into space. (Dr. Jack [Hunter] Waite/Southwest Research Institute)</p>	<p>ICEE Program</p>
 <p>Surface Dust Mass Analyzer (SUDA)</p>	<p>This instrument will measure the composition of small, solid particles ejected from Europa, providing the opportunity to directly sample the surface and potential plumes on low-altitude flybys. (Dr. Sascha Kempf/University of Colorado, Boulder)</p>	<p>ICEE Program</p>

NEW HEAT SHIELD TO PROTECT MISSION TO THE SUN

Technology Infused: NASA-sponsored technology has been employed to develop a state-of-the-art heat shield that will enable an important Heliophysics mission—the Solar Probe Plus (SPP). The newly developed carbon-composite heat shield will protect the spacecraft from the impacts from hypervelocity dust particles and the extreme temperatures it will experience as it travels closer to the sun than any spacecraft has ever been before. The 8-foot-diameter, 4.5-inch-thick, carbon-foam-filled solar shield will be placed atop the spacecraft body, facing the sun.

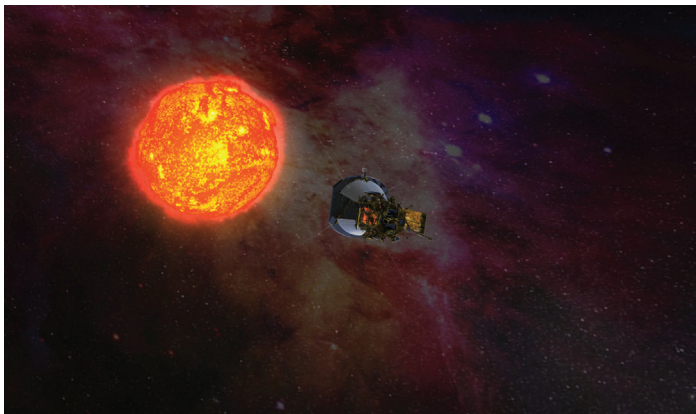

Artist's rendering of Solar Probe Plus with its solar panels folded into the shadows of its protective heat shield, as it gathers data on its approach to the sun. (Credit: NASA/JHU/APL)

Impact: This new heat shield will enable SPP to meet its goal of answering two fundamental science questions:

- (1) Why is the sun's outer atmosphere so much hotter than the sun's visible surface?
- (2) What accelerates the solar wind that affects Earth and our solar system?

To gather the data needed to understand these phenomena, SPP will fly into the sun's outer atmosphere—the corona—to make in situ measurements of the solar wind. The solar wind is a supersonic stream of mostly charged particles continuously emitted by the sun into the interplanetary medium. Disturbances in the solar wind can generate disruptions in near-Earth space—such as geomagnetic storms—that interfere with radio communications and GPS applications. To gather its data, SPP will orbit the sun 24 times, using seven different Venus fly-bys to gradually reduce its distance from the sun. During its closest three passes, SPP will be just 3.8 million miles from the surface of the sun—about seven times closer than any previous spacecraft. Although SPP will be exposed to temperatures up to 2,500° Fahrenheit (about 1,400° Celsius), the newly developed heat shield will help maintain a payload temperature close to room temperature, which will enable the suite of instruments on the spacecraft to function.

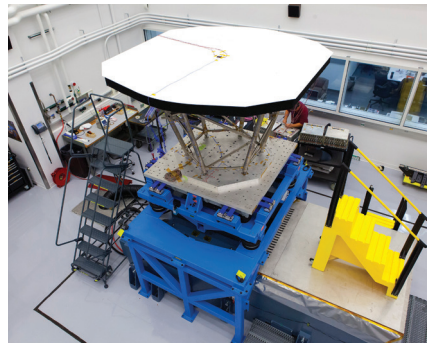

The heat shield on a vibration test fixture after thermal tests proving its efficacy.

Status and Future Plans: The SPP heat shield completed the full complement of subsystem tests in 2015 to demonstrate the required functionality of the thermal protection system.

Observatory-level testing will be initiated in 2016, during which the full compatibility of the individual subsystems will be validated. At the conclusion of the observatory-level integration and test program in 2017, SPP will be shipped to Kennedy Space Center for final integration and launch in 2018.

Sponsoring Organization: Through its Living With a Star Program, the NASA Heliophysics Division provided funding to the Johns Hopkins Applied Physics Laboratory to develop the SPP heat shield technology.

GAME-CHANGING BALLOON TECHNOLOGY ENABLES NEAR-GLOBAL FLIGHT

Technology Infused: After over 20 years of tests and development, NASA's Balloon Program team is on the cusp of expanding the envelope in high-altitude, heavy-lift ballooning with its super pressure balloon (SPB) technology. SMD technology investments that enabled development of SPB, the first totally new balloon design in more than 60 years, include improved film and evolution in the balloon design and fabrication. The pumpkin-shaped, football stadium-size balloon is made from 22-acres of polyethylene film—a material that is similar to a sandwich bag, but is stronger and more durable. The SPB is capable of ascending to a nearly constant float altitude of about 35 km for flights lasting up to 100 days, given the right stratospheric conditions. Flying at mid-latitudes, the balloon must be able to endure the pressure changes that



NASA SPB being inflated at the Wanaka Airport before its launch on March 26, 2015.

result from the heating and cooling of the day-night cycle. NASA expects the SPB to be capable of circumnavigating the globe once every one to three weeks, depending on wind speeds in the stratosphere. On March 26, 2015, NASA launched the second SPB flight from Wanaka, New Zealand. The balloon flew 32 days, five hours, and 51 minutes, on a voyage nearly around the world in what was the most rigorous test of the SPB technology to date. The 2015 mission accomplished what no other heavy-lift balloon had done by maintaining a nearly constant float altitude in stratospheric conditions. NASA terminated the balloon's flight over a remote area of the Australian Outback after suspecting a leak in the balloon. Back on the ground, the team recovered the balloon and shipped it back to the United States for analysis. The ensuing investigation concluded that the most likely cause of the suspected leak was a gradual slipping of the balloon material at the metal fittings on the base and top of the balloon structure.

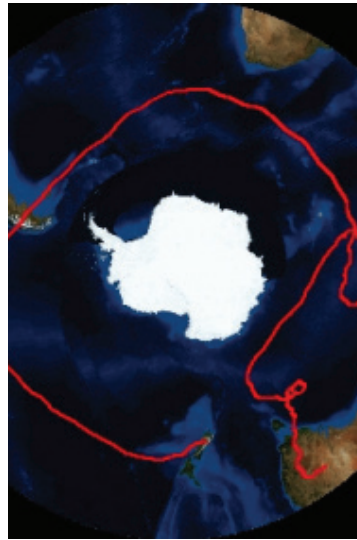

The path of the March 2015 SPB flight. The balloon almost made a complete trip around globe before its flight was terminated over the Outback in Australia.

Impact: NASA's scientific balloons offer low-cost, near-space access for scientific payloads in the ~450 kg weight class. Balloon campaigns are used to conduct scientific investigations in fields such as astrophysics, heliophysics, and atmospheric research. The long-duration flights enabled by SPB technology will allow extended observations of scientific phenomena, permit more sources to be surveyed, and provide

more time to observe weak or subtle sources. In addition, such mid-latitude flights are essential for making observations at night, a requirement for certain types of scientific investigations. These aspects greatly enhance the return on science, and combined with the relatively low cost of balloon missions, could permit the SPB to become a competitive platform for a number of scientific investigations that would otherwise need to launch into orbit.

Status and Future Plans: To address the issues uncovered in the March 2015 flight, the SPB team implemented modifications to change the way the balloon is clamped at the metal fittings, including incorporation of a gasket. In addition, the team increased the clamping force at the fittings. The SPB is scheduled to make its next flight in Spring 2016, again from the Wanaka Airport. Scientists are confident that the changes made in response to the previous 2015 flight will enable another successful flight.

Sponsoring Organization: SMD's Scientific Balloon Program sponsored the technologies enabling SPB development. NASA's Wallops Flight Facility in Virginia manages the Agency's scientific balloon flight program.

EARTH VENTURE SUBORBITAL-2 AWARDS INCLUDE SMD-SPONSORED TECHNOLOGY INFUSIONS

Technologies Infused: In 2015, NASA funded six new suborbital Earth Venture-class missions—five of which include technologies infused from SMD-sponsored technology development efforts. Managed by the Earth System Science Pathfinder Program (ESSP), the NASA Earth Venture program funds competitively selected, low-to-moderate cost, small-to-medium-sized, innovative missions to address a variety of Earth science topics. There are currently three categories of Earth Venture awards: (1) Earth Venture Missions (EVM), which involve full orbital missions; (2) Earth Venture Suborbital (EVS) missions and campaigns, which employ aircraft, balloons, sounding rockets, and other suborbital assets; and (3) Earth Venture Instruments (EVI), which are instruments that require final development for future use in orbit. Since the program's inception in 2010, SMD-sponsored technologies have played key roles in nearly every Earth Venture selection, and the most recent solicitation—Earth Venture Suborbital-2—was no exception.



Impact: Sustained SMD technology investment is enabling NASA to regularly solicit quick-turnaround projects, as

recommended by the NRC in the 2007 Earth Science Decadal Survey. The particular missions awarded by the Earth Venture Suborbital-2 solicitation will allow scientists to learn more about melting glaciers, atmospheric chemistry and air pollution, ocean warming, greenhouse gas sources, and the effect of fires in Africa on clouds. The information gained from these suborbital missions will complement the science obtained via other NASA initiatives that employ ground-based and Earth-orbiting assets.

Status and Future Plans: Funding for the Earth Venture Suborbital-2 projects extends from 2015 - 2020. Each of these projects is funded at a total cost of no more than \$30 million, to include initial development, field campaigns, and analysis of data. Selection announcements for Earth Venture Mission-2 and Earth Venture Instrument-3 are anticipated in 2016.

Sponsoring Organization: The Earth Science Division supported development of the technologies infused into the Earth Venture Suborbital-2 projects through the IIP.

SMD TECHNOLOGY INFUSIONS: EARTH VENTURE SUBORBITAL-2 AWARDS

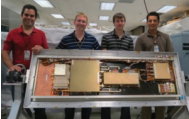
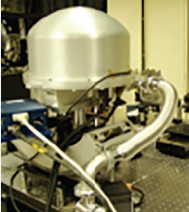
Project Name	Project Description (SMD technology infusions and PIs indicated in bold)
 <p data-bbox="349 394 690 451">North Atlantic Aerosols and Marine Ecosystems Study (NAAMES)</p>	<p data-bbox="743 338 1502 506">PI: Michael Behrenfeld, Oregon State University - NAAMES seeks to improve our understanding of how ocean ecosystems might change with ocean warming. NAAMES utilizes the High Spectral Resolution Lidar (HSRL - Johnathan Hair/Chris Hostetler, LaRC) instrument (shown at left onboard the UC-12 aircraft) to measure the vertical distribution of aerosols within the atmosphere and phytoplankton to three optical depths (~45 m) in the ocean.</p>
 <p data-bbox="349 646 690 703">Atmospheric Transport and Carbon-America (ACT-America)</p>	<p data-bbox="743 604 1502 743">PI: Kenneth Davis, Pennsylvania State University - ACT-America is also using the HSRL instrument (see above) as well as the Multi-Functional Fiber Laser Lidar (MFL - Michael Dobbs, ITT Excelis) shown at left to quantify the sources of regional carbon dioxide, methane and other gases, as well as document how weather systems transport these gases in the atmosphere.</p>
 <p data-bbox="349 884 657 961">ObseRvations of Aerosols above CLouds and their interactions (ORACLES)</p>	<p data-bbox="743 856 1502 995">PI: Jens Redemann, Ames Research Center - the ORACLES campaign, which is investigating how biomass burning in Africa influences cloud cover over the Atlantic, includes the Airborne Second Generation Precipitation Radar (APR-2 - Eastwood Im/Steve Durden, JPL) instrument (Steve Durden with the APR-2 at left) and the Airborne Multiangle SpectroPolarimetric Imager (AirMSPI - David Diner, JPL).</p>
 <p data-bbox="349 1161 665 1188">Oceans Melting Greenland (OMG)</p>	<p data-bbox="743 1106 1502 1245">PI: Josh Willis, JPL - The OMG campaign will utilize the Airborne Glacier and Land Ice Surface Topography Interferometer (GLISTIN-A - Delwyn Moller, Remote Sensing Solutions) instrument to investigate the role of warmer, saltier Atlantic subsurface waters in Greenland glacier melting. (At left: GLISTIN team members with an antenna panel).</p>
 <p data-bbox="349 1398 649 1455">COral Reef Airborne Laboratory (CORAL)</p>	<p data-bbox="743 1358 1485 1497">PI: Eric Hochberg, Bermuda Institute of Ocean Science - The CORAL campaign aims to provide critical data and new models to analyze the status of coral reefs and to predict future changes. CORAL is using the Portable Remote Imaging SpectroMeter (PRISM - Pantazis Mouroulis, JPL) instrument (shown at left) to acquire spectral image data related to reef health.</p>

MAPPING HYDROGEN TO LOCATE WATER ON THE MOON

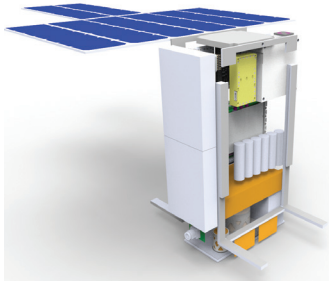
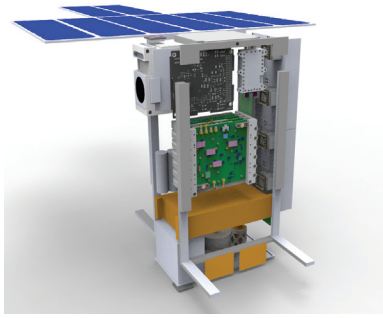

LunaH-Map Spacecraft Design (cutaway views).

Technology Infused:

The Lunar polar Hydrogen Mapper (LunaH-Map) mission is a CubeSat that will detect the amount of hydrogen at the moon's South Pole. Designed to fly around the moon in a polar orbit at low altitude (5-12 km), LunaH-Map will carry two newly designed neutron spectrometers to produce high-resolution maps of near-surface hydrogen. Previous moon missions have indicated that

there is an abundance of hydrogen near the lunar poles, but the exact locations were not determined. The presence of hydrogen indicates the presence of water, and LunaH-Map will provide important constraints on the location and abundance of ice deposits near the lunar South Pole. The spectrometers on LunaH-Map will measure the energies of neutrons that have interacted with and subsequently leaked back out of the material in the top meter of the lunar surface. To accomplish this task, the mission will employ new technology—an elpasolite scintillation detector—in an array of neutron detectors mounted to one face of the spacecraft. These new detectors enable efficient neutron detection capability in a small package, making them ideal for use on a CubeSat platform.

Impact: LunaH-Map will produce maps of hydrogen abundance with the highest spatial resolution ever acquired by a neutron detector from orbit, and will demonstrate the capability of a CubeSat platform to acquire neutron counts from planetary surfaces. Understanding the distribution of hydrogen on the surface of the moon will help NASA plan future missions to the moon, especially missions that will land on the surface. Knowing the location and volume of ice deposits will also be vital to future moon missions that plan to make use of in situ resources—for example, a human mission to the moon. LunaH-Map will also use a highly efficient ion propulsion system to maneuver itself from the Space Launch System (SLS) into a stable lunar orbit, and finally a

science mapping orbit. LunaH-Map and Lunar IceCube will be the first two interplanetary CubeSats to demonstrate this technology in space on a small spacecraft platform.

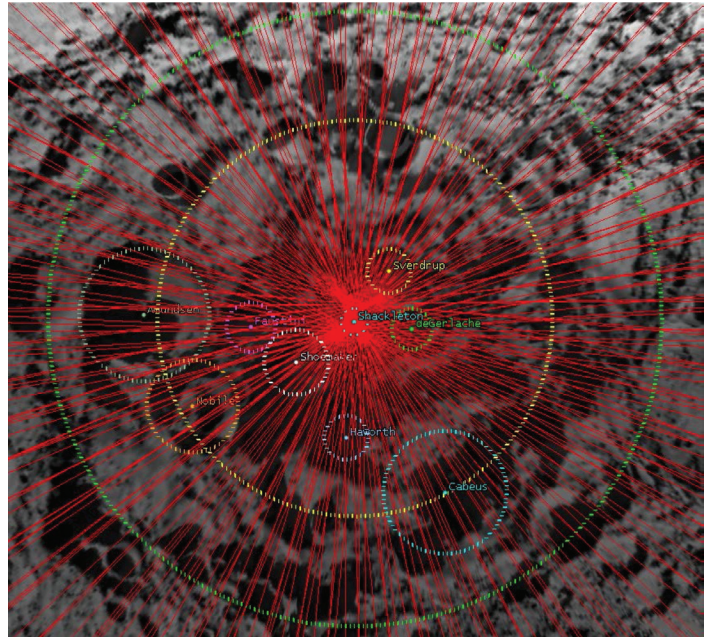

Orbit ground track shown in red for the entire 60 (Earth) day LunaH-Map science phase: 141 passes over target area initially (and periodically) centered on Shackleton Crater with close-approach of 5 km at each perilune crossing. Yellow circle denotes LunaH-Map altitude of 8 km; green circle denotes LunaH-Map altitude of 12 km.

Status and Future Plans: LunaH-Map is one of 13 CubeSats scheduled for launch on the first integrated flight of NASA's Space Launch System and Orion spacecraft in 2018. LunaH-Map is being designed, built, and tested at Arizona State University. Industry partners will design, build, and deliver the spectrometers for integration into the spacecraft.

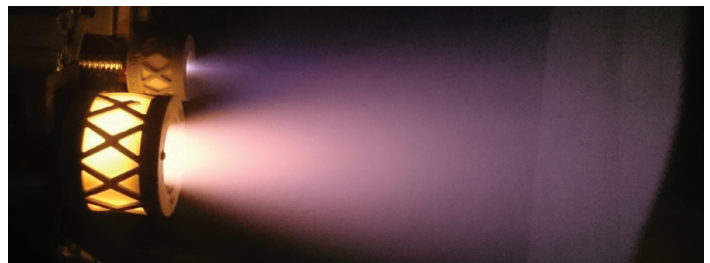

Busek's 65W iodine-fueled ion propulsion system "BIT-3," currently scheduled to fly on the LunaH-Map and Lunar IceCube missions.

Sponsoring Organization: PSD provides funding for the LunaH-Map effort via the PICASSO program. PI, Craig Hardgrove, resides at Arizona State University. STMD's SBIR program provides funding for technology development related to the detector component of the spectrometer to Radiation Monitoring Devices, Inc. and the ion propulsion system to Busek Co. Inc.

TINY THRUSTERS DEMONSTRATE A CAPABILITY NEEDED TO DETECT GRAVITATIONAL WAVES

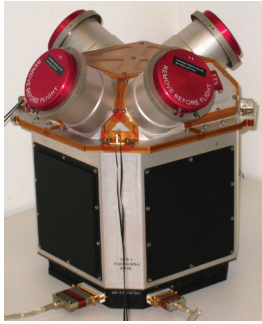

This cluster of four colloid thrusters is part of the Disturbance Reduction System, developed by NASA/JPL, which will help keep the LISA Pathfinder spacecraft extremely stable. (Image credit: ESA/NASA/JPL-Caltech)

Technology Infused: On December 3, 2015, the LISA Pathfinder mission blasted into space carrying the most stable spacecraft thruster system ever qualified for use in space. Developed by NASA JPL, the Space Technology 7 (ST-7) Disturbance Reduction System (DRS) is designed to control the spacecraft's position to within a millionth of a millimeter. ST-7 DRS consists of clusters of colloid micronewton thrusters and control software residing on a dedicated

computer. To operate, the thrusters apply an electric charge to small droplets of liquid and accelerate them through an electric field. This new thruster technology has never successfully been used in space before. ST-7 DRS will deliver extremely small pulses of energy (5 to 30 micronewtons of thrust) to precisely control the LISA Pathfinder spacecraft.

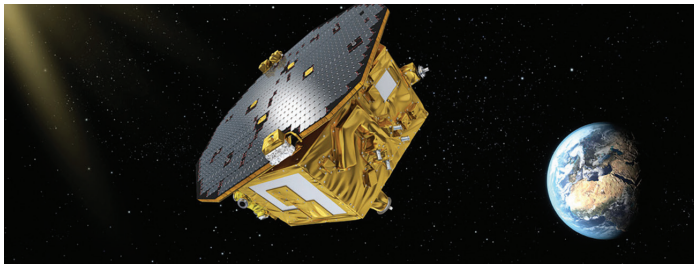

The LISA Pathfinder spacecraft will help pave the way for a mission to detect gravitational waves. NASA/JPL developed a thruster system onboard. (Image credit: ESA)

Impact: Precise spacecraft control is vital to achieve the LISA Pathfinder goal: demonstrating technology concepts required to detect low-frequency gravitational waves. Gravitational waves are incredibly faint. The magnitude of oscillation is on the order of tens of picometers—one picometer is one trillionth of a meter—which is why it is critical to keep the spacecraft stable enough to detect the waves. The LISA Pathfinder contains two test masses—objects designed to respond only to gravity (to the greatest extent possible). These test masses are made of a mixture of gold and platinum so that they will be very dense, but also non-magnetic. They each weigh about 4 pounds (2 kilograms) and measure 1.8 inches (4.6 centimeters) on

each side. The LISA Pathfinder spacecraft is intended to shield the test masses from external forces so that they follow a trajectory determined only by the local gravitational field. The dominant force to overcome is solar pressure, which pushes on the spacecraft and is the equivalent of about the weight of a grain of sand. By precisely measuring the position of the freely floating test masses, the ST-7 DRS uses its “micro-rocket” thrusters to keep the spacecraft centered about the test masses. In effect, the spacecraft essentially flies in formation with the test masses, using onboard sensor information (provided by the European LISA Technology Package) to control the thrusters and keep the test masses totally isolated from external forces. By measuring their relative motion, a future mission could use such test masses as references in the quest to detect gravity waves.

Status and Future Plans: ST-7 DRS is one of two thruster systems being tested on the LISA Pathfinder mission (the other system was developed by the European Space Agency). If successful, there are numerous potential uses for this technology in the future. For example, the system could be used to stabilize a future spacecraft that needs to be very still to detect exoplanets. ST-7 DRS could replace the reaction wheels that help control a spacecraft's orientation, reducing the overall mass of the spacecraft. The thruster system could also be used to enable spacecraft to fly in formation. For example, a constellation of small satellites flying together could use these thrusters to remain highly synchronized.

Sponsoring Organization: The Astrophysics Division provided funding via the SAT program to PI John Ziemer at NASA JPL to support development of the ST-7 DRS.

COMPUTING ADVANCES TO ENABLE SPEEDY NEW ROVER ON THE RED PLANET

Technology Infused: The Mars 2020 mission has recently adopted a baseline that includes SMD-sponsored technology developments that will enable its rover to drive faster, more safely, and with improved energy efficiency. Planetary rovers have traditionally been limited by the available computational power of space-qualified processors. For example, when the Mars Science Laboratory (MSL) rover drives autonomously, its limited computation capability forces it to stop for a substantial period while the navigation software identifies a hazard-free path using acquired imagery. The resulting limitation on

driving duty cycle reduces the MSL rover's average traverse rate. FastTraverse leverages newly available avionics—large, reprogrammable, radiation-hardened Field Programmable Gate Arrays (FPGAs)—to enable faster and higher resolution image processing. A synergistic set of software changes enables navigation processing and driving to occur simultaneously. In other words, a rover using FastTraverse technology will be capable of “thinking while driving.” FPGAs are inherently well suited to massively parallel computation in general, and to enabling the computer vision required by rovers in particular. The FastTraverse project has transitioned the most computation-intensive portions of autonomous navigation processing from the rover's main central processing unit to an FPGA coprocessor. FPGA implementation enables higher resolution processing in a small fraction of the time required by general-purpose, space-qualified processors. What currently takes many seconds or even minutes using state-of-the-art, radiation-hard processors can be accomplished in milliseconds using FPGA implementations.

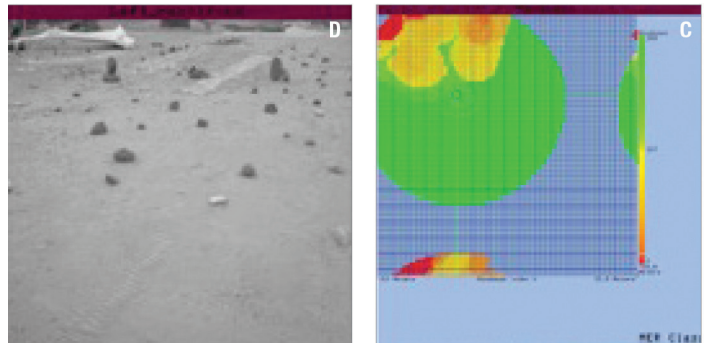

Images of JPL's MarsYard test facility taken by the MSL's Vehicle System Testbed (VSTB) (left) and the resulting terrain “goodness” map (right) generated by the Rover's autonomous navigation software.

Status and Future Plans: In 2015, FastTraverse was integrated with and demonstrated on MSL's Vehicle System Testbed, performing autonomous navigation in JPL's outdoor MarsYard facility. The FPGA-enhanced capabilities demonstrated included hazard detection/avoidance and visual odometry (determination of rover position and orientation by analyzing acquired images). The Mars 2020 flight mission will incorporate FastTraverse technology into its rover, further maturing the technology as needed.

Sponsoring Organization: FastTraverse was enabled by two SMD-funded technology programs, both led by Michael McHenry at NASA JPL. Work on FastTraverse progressed under the Mars 2018 Focused Technology Program in fiscal years (FY) 2011-12, while the technology was at lower TRLs, and starting in FY2013, the Mars Technology Development Program raised the TRL to a higher level to enable infusion in late FY2015.

NEW TECHNOLOGIES ENABLE STUDY OF MAGNETIC RECONNECTION IN SPACE

Technology Infused: In March 2015, NASA launched an exciting new mission to investigate how the sun's and Earth's magnetic fields connect and disconnect, explosively transferring energy from one field to the other. This process—called magnetic reconnection—influences celestial bodies throughout the solar system, including our home planet. The Magnetospheric Multiscale (MMS) mission is one of NASA's most complex missions, involving the integration of over 100 instruments into four spacecraft flying in formation. Magnetic reconnection occurs in the thin, fast moving, and largely unpredictable electron diffusion regions (EDR) of Earth's magnetosphere. To measure the processes occurring in the EDR, the four MMS spacecraft must capture data at a rate 100

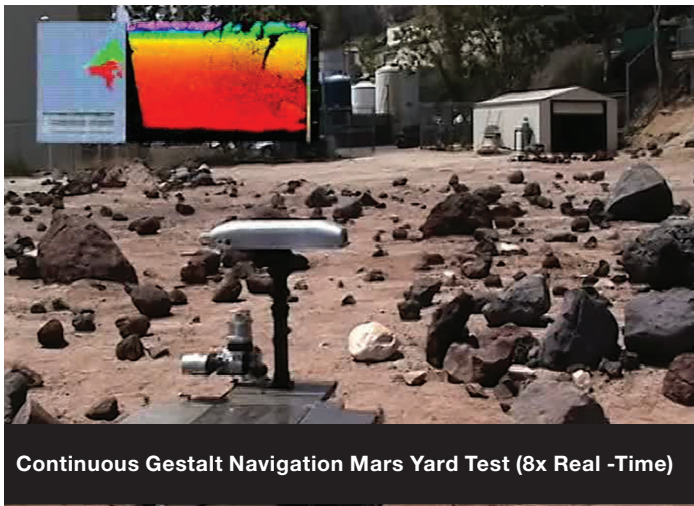

Continuous Gestalt Navigation Mars Yard Test (8x Real -Time)

Frame capture of a video documenting the navigation performance of the FPGA-based system. Overlays show the derived stereo image range map and terrain goodness map.

Impact: By enabling faster and higher-resolution image processing, FastTraverse will reduce, if not eliminate, the need for the rover to halt while performing the processing associated with autonomous rover navigation, thus enabling continuous traverses. Using the FastTraverse technology, the Mars 2020 rover is expected to be able to travel 60-80 meters/hour—much faster than the current rover rates of 15-35 meters/hour. In addition to increasing traverse rates, FastTraverse technology enables safety checks to be run more frequently and reduces the total energy required for the rover to navigate to a goal, thereby leaving more time and energy for science.

times faster than previous missions, all while flying in tight formation. Development of MMS required NASA to overcome several engineering challenges using new technologies that, in some cases, took over a decade to mature.

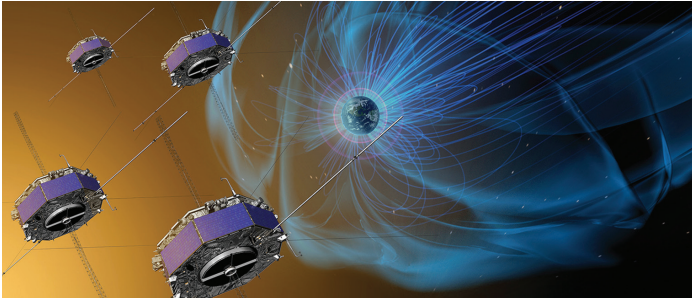

NASA's Magnetospheric Multiscale mission (shown here in an artist concept) flies through the borders of the magnetic fields around Earth to better understand how they connect and disconnect with similar magnetic fields coming from the sun. Such magnetic reconnection can explosively release energy and particles into near-Earth space.

MMS will fly through magnetic regions near Earth, speeding through them in under a second, so the onboard sensors must gather measurements amazingly fast compared to the prior state of the art. One of the speediest instruments developed for MMS is the Fast Plasma Investigation (FPI), which was based on technology developed through earlier SMD investments. FPI will gather a full sky map of data some 30 times per second—100 times faster than any previous similar instrument. FPI measures the charged particles, or plasma, present in magnetic reconnection sites. The FPI experiment includes four detectors on each MMS spacecraft to measure electrons and four to measure ions. Each detector is, in turn, made of two sensors that can scan through a 45-degree arc for a larger panorama. Each pair of ion sensors can produce a three-dimensional picture of the ion plasma every 150 milliseconds; each pair of electron sensors do the same for the electrons every 30 milliseconds. While transporting this much data is easy on Earth using high-speed Internet, it is difficult in space, where the data rate would quickly overwhelm the mission's S-band allocation for downlinking data. To solve this problem, the MMS mission made use of new data compression techniques originally developed by NASA's Space Communication and Navigation Program. The MMS team successfully infused this data compression technology into the mission, increasing its TRL to a flight-ready level through a rigorous test program, and then incorporating it into the FPI instrument.

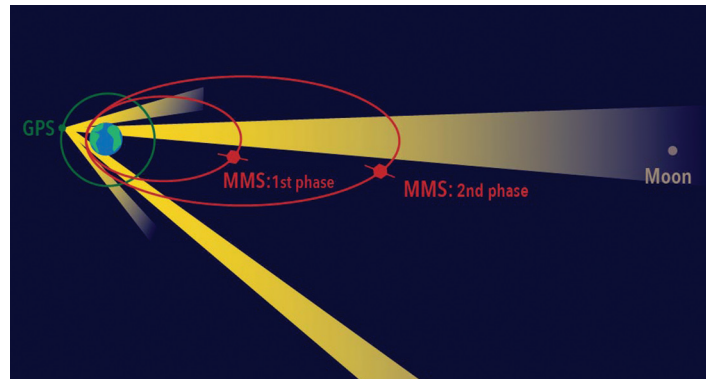

The red ellipses show the MMS orbit paths during the first and second phases of the mission. Each spacecraft uses GPS signals—which come from satellites situated along the green circle shown surrounding Earth—from the far side of Earth to track its position.

Impact: Magnetic reconnection is responsible for the space weather that can adversely affect modern technological systems on Earth, such as telecommunications networks, GPS navigation, and electrical power grids. The FPI and data compression system provide essential capabilities that are enabling MMS to achieve its mission goal of measuring the plasma and the electric and magnetic fields inside the diffusion regions of Earth's magnetosphere. Armed with these data, scientists hope to be able to understand the magnetic reconnection process and perhaps predict its effects in space and on Earth.

Status and Future Plans: After a successful launch on March 12, 2015, MMS traveled through space to reach a region on the sun-side of Earth, where it is executing the first phase of the mission. During this first phase, the FPI system has worked as planned and the data indicates an even higher number of reconnection region detections than previously hoped. In fall 2016, NASA plans to move MMS to Earth's night-side to complete the second phase of its mission in an orbit that extends almost 99,000 miles away from Earth, nearly halfway to the moon.

Sponsoring Organization: The Heliophysics Division provided funding to Goddard Space Flight Center to conduct the technology development required to improve the sensitivity and data rate of heritage instruments, enabling development of the FPI.

NEW SYSTEM PUT INTO SERVICE TO PROCESS NEPAL EARTHQUAKE DATA

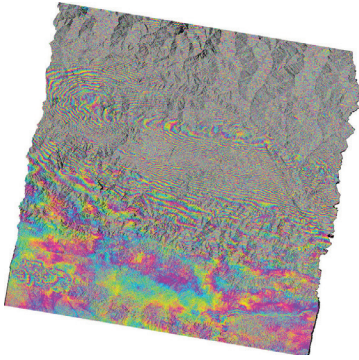

This interferogram shows part of the very large deformation caused by the 2015 magnitude 7.8 earthquake in Nepal, including the capital city of Kathmandu. The color contours, or fringes, are 2.8 cm (1.1 inches) each and reflect the surface deformation caused by fault slip at depths of 12-16 km. The area just north of Kathmandu moved upward about 1.4 m due to the earthquake. (Credit: Hook Hua, JPL)

Technology Infused: On April 25, 2015, a magnitude 7.8 earthquake struck the mountainous nation of Nepal, causing widespread destruction and loss of life. Known as the Gorkha Earthquake, the event was the largest earthquake to strike the country in over 80 years. During the initial response to the quake, scientists processed data manually, developing images called interferograms one at a time to show deformations that occurred on the

Earth's surface as a result of the earthquake. Within a week, the Advanced Rapid Imaging and Analysis (ARIA) project—a collaboration between NASA's Jet Propulsion Laboratory and the California Institute of Technology—automated and customized many aspects of the process to increase efficiency. To achieve this improvement, the ARIA center utilized parts of a PSD-funded technology development project, ARIA for Monitoring Hazards (ARIA-MH). ARIA-MH seeks to enable rapid generation of products to monitor hazards and for situational awareness during disasters. Specifically, ARIA-MH is developing a service-oriented hazard and disaster-monitoring data system that will enable both the scientific and decision-support communities to monitor ground motion using Global Positioning System (GPS) and Interferometric Synthetic Aperture Radar (InSAR) data.

Impact: Although the system is not yet fully operational, scientists leveraged ARIA-MH to rapidly process and re-process interferograms generated using InSAR data from the European Union's Copernicus Sentinel-1A satellite in a highly parallel cloud-computing environment. Scientists use these maps to build detailed models of faults, to show the ground motion caused by recent earthquakes, and to study the potential impact of future earthquake activity. The automation and scaled-up processing enabled by ARIA-MH significantly sped up the turnaround time required to process the Nepal earthquake data, enabling scientists to quickly assess new data and reprocess scenes with additional customizations and tweaks.

Status and Future Plans: The ARIA team is working to make these capabilities a fully operational part of the ARIA suite of tools.

Sponsoring Organization: The Earth Science Division supports development of ARIA-MH technology through the AIST program. Hook Hua of NASA JPL is PI for the ARIA-MH project.

APPENDIX A. THE SMD TECHNOLOGY DEVELOPMENT STRATEGY

Each SMD science division invests in technology development programs that complement, support, and enable the implementation of the division's strategic science plan. The SMD Chief Technologist works with the SMD senior leadership team to coordinate the development and utilization of technology across the entire directorate. The Agency's airborne and in-space flight missions, along with its scientific research and analysis (R&A) programs, represent the primary customer base for SMD's technology development efforts. Studies have shown that technology readiness is especially important for flight missions because the maturity of a mission's onboard instruments and space components significantly impacts the cost and risk of the mission¹. SMD's approach is to mature required technologies years in advance of flight mission implementation, thereby retiring risk, reducing cost, and increasing the likelihood that new technologies will be incorporated into flight projects.

Along with other organizations outside of SMD, the Space Technology Mission Directorate (STMD) is an important SMD partner in this process, particularly for technology development efforts that are applicable Agency-wide. SMD consults and collaborates with STMD to identify new opportunities, develop specific solicitations, co-fund technology developments, and review and evaluate ongoing developments with a view toward technology infusion. Leveraging STMD's crosscutting technology developments and STMD support of nascent, highly innovative concepts has resulted in a more strategically balanced technology portfolio for SMD and has enabled

¹ U.S. Government Accountability Office. NASA Assessments of Selected Large-Scale Projects. GAO-12-207SP. Washington, D.C.: U.S. Government Printing Office, 2012. This report concluded that the maturity of instruments and space components impacts the cost and risk of flight missions (i.e., proposed flight missions should include technologies at TRL 6 or greater).

SMD technology programs to better focus on near- to mid-term mission needs. The SMD Chief Technologist is the directorate's primary interface to STMD; to other NASA organizations responsible for technology development, such as the Office of the Chief Engineer (OCE); and to entities external to the Agency that also develop advanced technologies, such as other domestic agencies, foreign space agencies, industry, and academia.

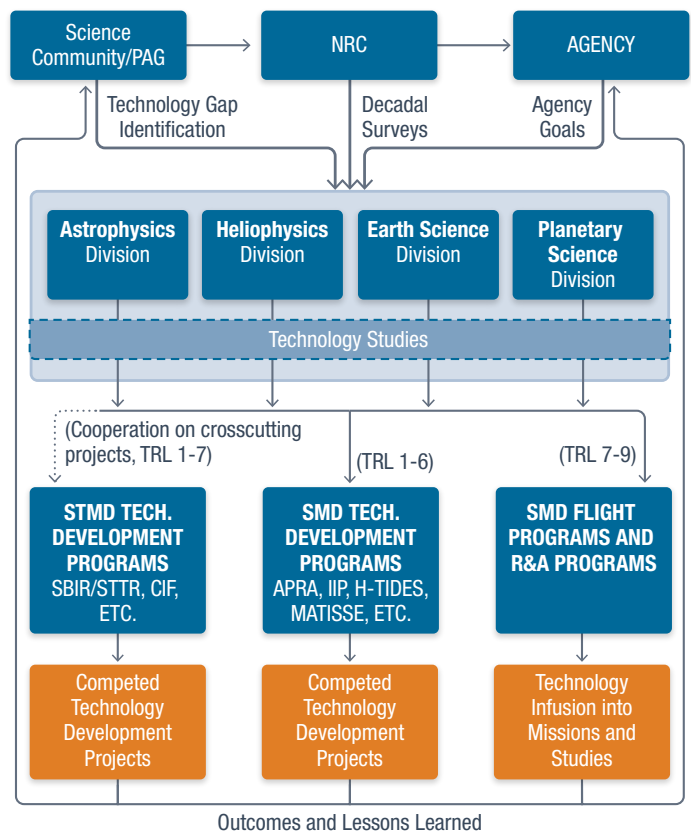

General SMD technology development process.

Effective technology development requires careful analysis of technology gaps, identification of technologies to fill

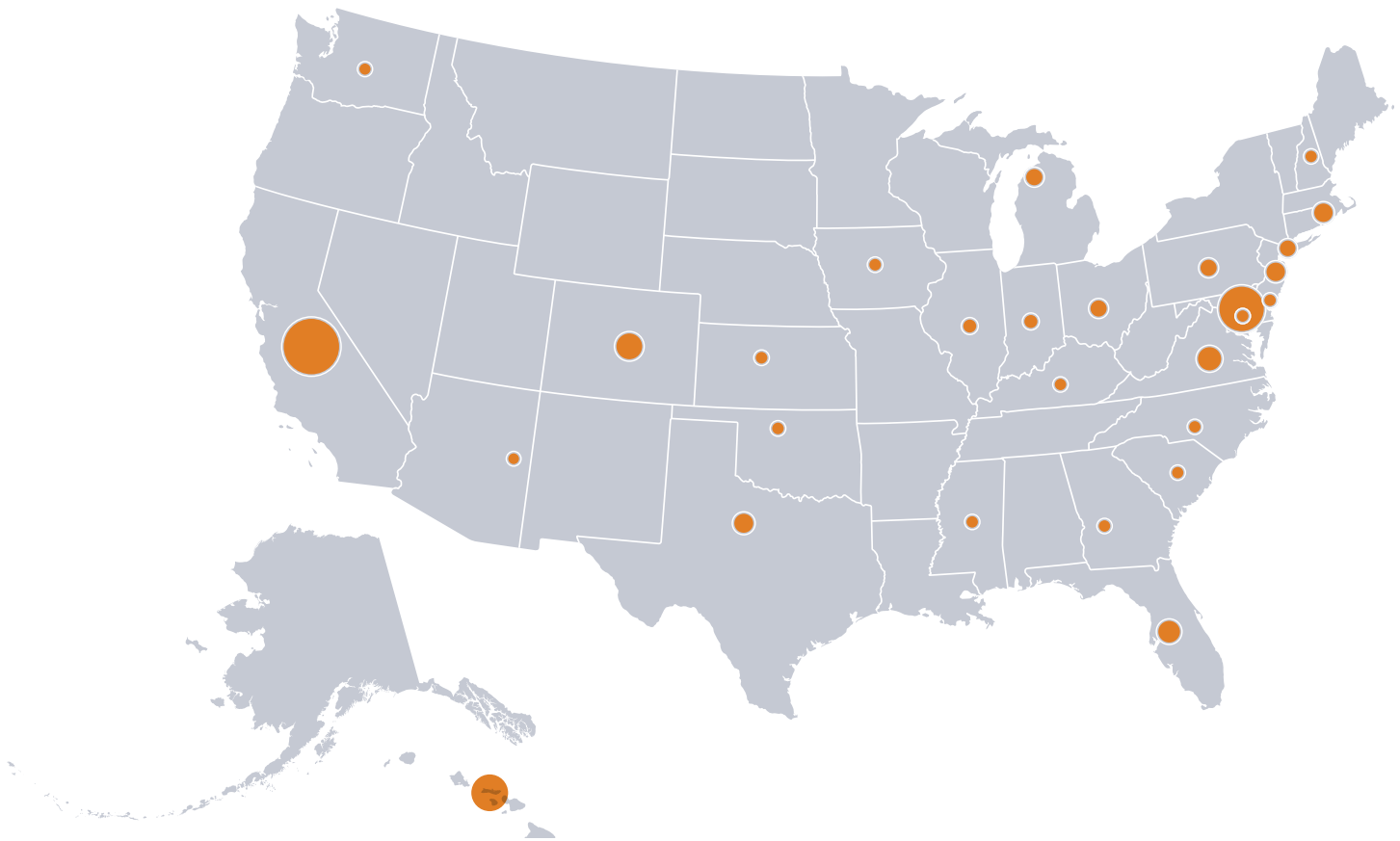

Distribution of PI institutions for SMD technology development efforts active in 2015; the size of the circle corresponds to the number of technology development efforts led by PIs in the state.

those gaps, and sustained investment to advance the chosen technologies. SMD executes most of its internal technology development through its divisions using the general process depicted on page 29. SMD applies this robust process to mature technologies to an advanced TRL such that they can be applied in a flight mission or scientific research and analysis project. Most internal SMD technology development efforts are related to science observations (instrument development) or information (data validation, processing). SMD also accomplishes technology development by establishing partnerships with other government agencies, higher education institutions, and industry. The directorate also funds student fellowship programs that contribute to technology development such as the Nancy Grace Roman Technology Fellowship and NASA Earth and Space Science Fellowship (NESSF). In addition, SMD leverages technology development efforts sponsored through research and development funds at the NASA centers.

Note that the SMD technology development process is cyclical, with information on SMD technology development

efforts provided to the organizations that, in turn, advise SMD. SMD divisions receive guidance from the NRC Decadal Surveys and the science community and direction from the Agency. The divisions carefully consider this input and determine the technology development efforts to invest in, based on science requirements. Each division accomplishes its internal technology development via competed opportunities offered through technology development programs (typically for technologies at TRLs 1-6) or via directed or competed flight programs (typically for technologies at TRLs 7-9). Many technology development efforts are guided by studies. SMD divisions establish their own technology development programs to actively manage internal technology development efforts that are implemented outside of flight programs, thus ensuring progress and value are achieved for the directorate’s investments. (See the table on page 4 for a list of SMD technology development programs.) Divisions organize their technology development programs to align with their specific needs; e.g., some divisions organize technology development programs according to the type of technology (instruments, observations, etc.) and some

according to TRL (low, medium). SMD sponsors various types of competed opportunities; some request ideas for development, others are in response to a specific set of division requirements. However, all competed technology development opportunities within SMD employ a peer review process to determine the optimal investment strategies. Many key technologies undergo independent technology readiness assessments during the development process. If a development effort achieves TRL 6, the technology may be targeted for infusion into an SMD flight program. Prior to infusion, appropriate technologies may first be tested in a flight environment on a suborbital platform (aircraft, rocket, or balloon). Once a technology is infused into a flight program, that program is responsible for refining the technology so that it can be used for the specific mission application. The science community and the Agency receive regular feedback regarding the progress of technology development efforts so they can influence SMD technology investments effectively.

This report highlights a sample of the activities comprising the broad portfolio of SMD technology projects. In 2015, SMD division technology development programs funded numerous projects distributed throughout the nation (see map at left). Principal Investigators (PIs) leading SMD technology development projects reside at various U.S. institutions.

ACRONYMS

2-D	Two-dimensional	EVI	Earth Venture Instruments
3-D	Three-dimensional	EVM	Earth Venture Missions
ACT	Advanced Component Technologies	EVS	Earth Venture Suborbital
AIST	Advanced Information Systems Technology	FLARE	Facility For Laboratory Reconnection Experiments
APR-2	Airborne Second Generation Precipitation Radar	FPA	Focal Plane Array
APRA	Astrophysics Research and Analysis	FPGA	Field Programmable Gate Array
ARIA	Advanced Rapid Imaging and Analysis	FPI	Fast Plasma Investigation
ARIA-MH	ARIA For Monitoring Hazards	FY	Fiscal Year
ASCENDS	Active Sensing of CO ₂ Emissions over Nights, Days, and Seasons	GCD	Game Changing Development
ASRG	Advanced Stirling Radioisotope Generator	GEO-CAPE	Geostationary Coastal and Air Pollution Events
CGI	Coronagraph Instrument	GLISTIN	Glacier and Land Ice Surface Topography Interferometer
CLASP	Chromospheric Lyman-Alpha Spectropolarimeter	GPHS	General Purpose Heat Source
CME	Coronal Mass Ejections	GPS	Global Positioning System
CO₂	Carbon Dioxide	GRC	Glenn Research Center
CORAL	Coral Reef Airborne Laboratory	GRIFEX	GEO-CAPE ROIC In-Flight Performance Experiment
CSA	Current Sheet Array	GSFC	Goddard Space Flight Center
DRIVE	Diversify, Realize, Integrate, Venture, and Educate	H₂O	Water Vapor
DRS	Disturbance Reduction System	HEEET	Heat-Shield For Extreme Entry Environment Technology
EDR	Electron Diffusion Regions	HLC	Hybrid Lyot Coronagraph
EIS	Europa Imaging System	HSRL	High Spectral Resolution Lidar
ESA	European Space Agency	H-TIDeS	Heliophysics Technology and Instrument Development for Science
ESSP	Earth System Science Pathfinder Program	IAC	Instituto de Astrofísica de Canarias
ESTO	Earth Science Technology Office	IAS	Institut d'Astrophysique Spatiale

ICEE	Instrument Concepts For Europa Exploration	NAAMES	North Atlantic Aerosols and Marine Ecosystems Study
ICEMAG	Interior Characterization of Europa Using Magnetometry	NAOJ	National Astronomical Observatory of Japan
IIP	Instrument Incubator Program	NESSF	NASA Earth and Space Science Fellowship
InSAR	Interferometric Synthetic Aperture Radar	NRC	National Research Council
InVEST	In-Space Validation of Earth Science Technologies	NSRP	NASA's Sounding Rocket Program
IPDA	Integrated Path Differential Absorption	NWNH	New Worlds, New Horizons
JAXA	Japan Aerospace Exploration Agency	OCE	Office of the Chief Engineer
JPL	Jet Propulsion Laboratory	OMG	Oceans Melting Greenland
JSC	Johnson Space Center	ORACLES	Observations of Aerosols Above Clouds and Their Interactions
LCAS	Low-Cost Access To Space	P-POD	Poly-PicoSatellite Orbital Deployer
LISA	Laser Interferometer Space Antenna	PI	Principal Investigator
LOWFS	Low Order Wavefront Sensing and Control	PIAA-CMC	Phase Induced Amplitude Apodization-Complex Mask Coronagraph
LunaH-Map	Lunar polar Hydrogen Mapper	PICASSO	Planetary Instrument Concepts for the Advancements of Solar System Observations
LUVOIR	Large Ultra-Violet Optical Infrared	PIDDP	Planetary Instrument Definition and Development Program
MASPEX	Mass Spectrometer For Planetary Exploration	PIMS	Plasma Instrument For Magnetic Sounding
MatISSE	Maturation of Instruments for Solar System Exploration	PRISM	Portable Remote Imaging SpectroMeter
MDL	Micro-Devices Lab	PSD	Planetary Science Division
MFLL	Multi-Functional Fiber Laser Lidar	PSTAR	Planetary Science and Technology through Analog Research
MISE	Mapping Imaging Spectrometer For Europa	R&A	Research and Analysis
MMS	Magnetospheric Multiscale	RCHS	Radial Core Heat Spreader
MOS	Multi-Slit Optimized Spectrometer	REASON	Assessment and Sounding: Ocean To Near-Surface
MRX	Magnetic Reconnection Experiment	RG0	Reduced Gravity Office
MSFC	Marshall Space Flight Center	RMS	Root Mean Square
MSL	Mars Science Laboratory	ROIC	Readout Integrated Circuit

RPS	Radioisotope Power Systems
SAR	Synthetic Aperture Radar
SAT	Strategic Astrophysics Technology
SBIR	Small Business Innovation Research
SLS	Space Launch System
SMAP	Soil Moisture Active Passive
SMD	Science Mission Directorate
SPB	Super Pressure Balloon
SPC	Shaped Pupil Coronagraph
SPP	Solar Probe Plus
SRG	Stirling Radioisotope Generator
ST-7	Space Technology 7
STMD	Space Technology Mission Directorate
SUDA	Surface Dust Mass Analyzer
SWE	Snow Water Equivalent
TCOR	Technology Development for Comic Origins Program
TDEM	Technology Development for Exo-planet Missions
TOF	Time-Of-Flight
TPCOS	Technology Development for Physics of the Cosmos
TPS	Thermal Protection System
TRL	Technology Readiness Level
VCHP	Variable Conductance Heat Pipe
WFF	Wallops Flight Facility
WFIRST	Wide-Field Infrared Survey Telescope
WISM	Wideband Instrument for Snow Measurement

National Aeronautics and Space Administration

NASA Headquarters

300 E Street SW

Washington, DC 20024-3210

www.hq.nasa.gov

www.nasa.gov