

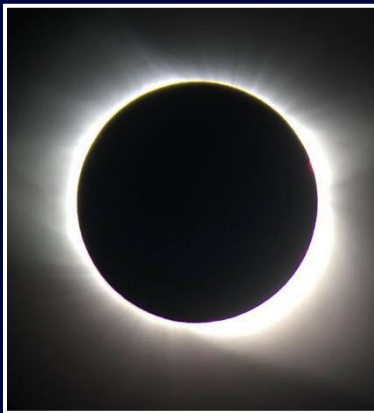

A Guide to Smartphone Astrophotography

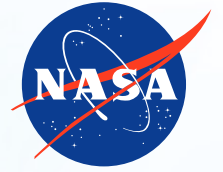



A Guide to Smartphone Astrophotography

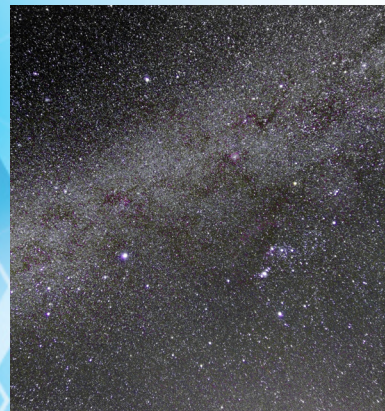
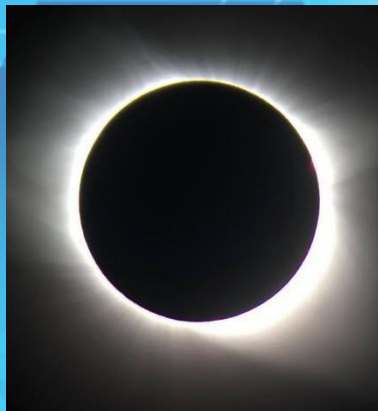
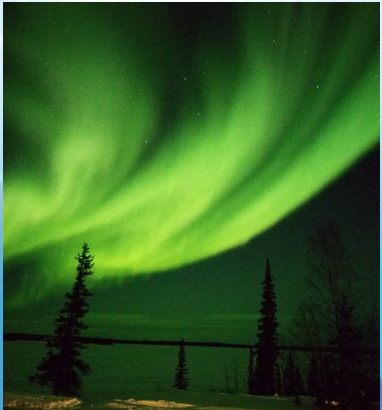

A Guide to Smartphone Astrophotography

Dr. Sten Odenwald

NASA Space Science Education Consortium

Goddard Space Flight Center

Greenbelt, Maryland

Cover designs and editing by Abbey Interrante

Cover illustrations Front: Aurora (Elizabeth Macdonald), moon (Spencer Collins), star trails (Donald Noor), Orion nebula (Christian Harris), solar eclipse (Christopher Jones), Milky Way (Shun-Chia Yang), satellite streaks (Stanislav Kaniansky), sunspot (Michael Seeboerger-Weichselbaum), sun dogs (Billy Heather). Back: Milky Way (Gabriel Clark)

Two front cover designs are provided with this book. To conserve toner, begin document printing with the second cover.

This product is supported by NASA under cooperative agreement number NNH15ZDA004C.

Table of Contents

Introduction.....	5
How to use this book	9
1.0 Light Pollution.....	12
2.0 Cameras	15
2.1 Basic Definitions	15
2.2 Spectral Response.....	16
2.3 Camera Sensors and Pixels - How They Work	16
2.4 The basic camera mechanism and controllable factors	21
2.4.1 Aperture size.....	21
2.4.2 The F-stop.....	23
2.4.3 Exposure speed.....	26
2.4.4 ISO.....	28
2.5 Sources of Noise.....	30
3.0 The art of calibration and why it works.....	31
3.1 But First A bit of Statistics	31
3.2 Gain Correction and Flat Fielding	33
3.3 Bias Frames	35
3.4 Dark Current	35
4.0 Which smartphone camera should I use?	41
5.0 Software.....	45
5.1 The Native Camera.....	45
5.1.1 Manual Mode.....	45
5.1.2 Low-Light Photography.....	46
5.2 Third Party Apps.....	49
5.3 Stacking and Adjusting apps	51
5.4 Intervalometers	52
6.0 External Equipment	52
6.1 Telephoto Lenses	52

6.2 Binoculars	57
6.3 Telescopes.....	58
7.0 Star field photography	60
7.1 Stellar Magnitudes	60
7.2 One-Shot Wonders.....	61
7.3 With a tripod – Now that’s more like it.....	62
7.4 Star Trails.....	71
8.0 Photographing the Moon	75
9.0 Photographing the Planets	80
10.0 Photographing Deep Sky Objects	84
10.1 The Orion Nebula – Messier 42.....	85
10.2 The Pleiades.....	88
10.3 Other Star Clusters.....	90
10.4 Other Nebulae	94
10.5 Galaxies	94
10.6 Supernova	103
11.0 Photographing the Sun.....	104
11.1 Solar Eclipse Photography.....	107
11.2 Lunar eclipses	112
11.3 Extra-solar Photography	113
11.4 Solar surface photography with telescopic imaging	116
11.4.1 Broadband Filters.....	117
11.4.2 Narrow-band Filters.....	121
12.0 Meteors and Comets	122
13.0 Photographing Artificial Satellites	127
13.1 The International Space Station.....	128
13.2 Starlink Satellites	131
14.0 Photographing the Aurora Borealis	137
14.1 Aurora Colors and Forms	137
14.2 Space Weather	139
14.3 When to look for them.....	142
14.4 How to photograph aurora.....	144
15.0 Noctilucent Clouds	148

16.0 Astrophotography for the sight-impaired	148
17.0 NASA Space Photography	149
18.0 Citizen Science Projects	169
18.1 Smartphone Astrophotography	169
18.2 Globe at Night.....	170
18.3 Night Sky Light Pollution.....	171
18.4 Satellite Streak Watcher	172
19.0 Joining a Community.....	174
19.1 Facebook Groups.....	174
19.2 Other Groups	175
20.0 Useful Tables.....	176
20.1 The Messier Catalog.....	176
20.2 Table of Solar Eclipses	180
20.3 Table of Lunar Eclipses	181
20.4 Interesting Planetary Appulses and Conjunctions	181
21.0 List of contributors for figures.....	182
22.0 Glossary of Terms.....	183
23.0 Index of Smartphones	186
24.0 References.....	188

Introduction

This book is a how-to guide for doing your own smartphone astrophotography and connecting with the magnificent universe to which we are a part. NASA has a vested interest in encouraging younger students and the public to better appreciate the night sky. For decades we have been involved in public education to connect the public with the many astronomical space missions whose discoveries grace the frontpages of our news feeds.

Recently, the NASA Space Science Education Consortium (NSSEC) at the Goddard Space Flight Center in Greenbelt, Maryland was set up to explore new ways to connect educators, students and life-long learners with the science and technology of NASA. The NSSEC works with many education groups around the country to develop new ideas that engage people with science, technology, engineering, art and math (we call this STEAM education). One of these is the Mobile Sensors Lab, which was created to explore how smartphone sensors can be used to make measurements of environmental factors such as light, magnetism, sound and radiation. Of course, the camera is the most obvious ‘sensor’ and as a former amateur astrophotographer I immediately started to explore how everyone could use their smartphones to conduct interesting space science projects on their own. Many of these projects are available through the citizen sciences app on your smartphone called Anecdata (also anecdata.org) and go by the names of *Satellite Streak Watcher*, *Night Sky Light Pollution*, and *Smartphone Astrophotography*, with more on the way. Meanwhile, I wrote this guide so that you can see just how easy and fun it is to create your own inspiring astrophotographs for whatever reason you choose to do so! It is a collection of best practices for how to use a smartphone to take photos of astronomical objects. It is based on the experiences of myself, as well as 50 other amateur photographers who gave their input.

Safety Note: Most of the photography will be at night so you need a red flashlight to see what you are doing and where you are walking. The last thing you want to do is knock over your tripod or take a fall while capturing that special shot. Also, when photographing the sun PLEASE DO NOT look at the sun directly. It is a good idea not to point your smartphone unfiltered at the sun because their sensitive low-light meters can be damaged. We will discuss these details in the chapter on photographing the sun.

As a professional astronomer I, like many others, got my start as a teenager by building my own telescope from scratch. My first one, a 4 ¼-inch Newtonian reflector was completed at age 13 but the views from suburban Oakland, California were not that grand. In high school I completed an 8-inch telescope, which was a real eye-opener for its spectacular views of lunar features, the planets and many deep-sky objects. My entry into astrophotography came at the age of 14 when I bought a second-hand 35mm Exa camera and tripod at a ‘flea market’. I spent many nights photographing the constellations from my suburban, light-polluted back yard, but my summer Boy Scout camping trips in the Sierra Nevada mountains provided me with the dark sites I needed. My 30-second photographs on Kodak Tri-X film were developed in my own darkroom

at home, and led to many spectacular and inspirational photographs, which spurred-on my interests in becoming an astronomer.

Time passed, and by 1975 I was enrolled in graduate school at Harvard. I would not return to the thrills of amateur astronomy and astrophotography again, even forsaking my own 8-inch telescope and camera gear for what I had access to professionally to further my research. Today, all I have left of this marvelous instrument is its tarnished mirror in a box in my closet! For the next 45 years I would follow the advancement of amateur astronomy, and the new camera systems available to them, with considerable envy. My teenage years were constrained by my very limited finances, which forced me to build what I needed including telescopes, clock drives and also developing my own film. Meanwhile, the trend I noticed during the 1980's and 90's was the explosion of companies offering relatively inexpensive (for a working adult) telescopes of astounding apertures from 3-inches (76-cm) to over 20-inches (508-cm). But the astrophotographs that covered the popular magazines were seldom created by people using very humble gear. More disturbingly, I had no sense at all that younger, teenage astronomers were represented. The cost of these commercial systems would be out-of-reach of most teenagers. Then something amazing happened.



In 2008 the smartphone-with-a-camera was introduced and literally swept the world. Almost immediately, they started becoming the go-to cameras for inexpensive astrophotography. As these cameras steadily improved to make them capture low-light scenery, they also evolved into the perfect astrocamera rivaling many of the expensive camera systems that astrophotographers had struggled with in the previous decades. Gone were the hours spent in darkrooms inhaling chemicals of dubious healthiness. Now programs such as *Photoshop*, and others developed by App designers, were available for digital photography.

Astrophotography is not a new subject. It has been the province of professional astronomers for most of the history of this subject since John Draper took the first telescopic photo of the moon back in 1840 using a 13-cm reflector. But amateur astrophotography started up almost immediately through the pioneering efforts of the English sanitation engineer Andrew Common (1841-1903) beginning in the 1870s. The challenges of this technique forced him to quickly abandon his 5-inch (127-cm) refractor and build a series of larger telescopes. After Common's death, his 1.5-meter telescope was purchased from his estate and installed at the Harvard College

Observatory. In 1933, the primary mirror was re-figured and a new mount built. It was then set up as the 1.5-meter Boyden-UFS reflector (also called the "*60-inch Rockefeller*") at the Boyden Observatory in South Africa. Meanwhile, by using a smaller 36-inch (0.9-m) telescope and exposing dry plates for up to an hour, Common captured stunning-for-the-times images of the Orion Nebula for which he won the Royal Astronomical Society's Gold Medal in 1884. When you consider that professional astronomers at their observatories were using telescopes not much larger than this for 'professional' photography, astrophotography in the 1800s was certainly something in which 'amateur' astronomers could equally participate if they had the resources, determination and of course a Day Job!

No one really knows who the first amateur astronomer astrophotographer was, but other than the 'gentleman astronomers' of the 1800's, by the early 20th century the American artist and engineer Russell Porter began giving public classes on building telescopes in August 1920. By 1923 the first meeting of the Springfield Telescope Makers Club became the core of a network of amateur astronomy clubs. This quickly led to a regular column in the magazine *Scientific American* called *The Amateur Scientist* by 1928. The magazine *Popular Astronomy* was published starting in 1893 and had articles of interest to professional and amateur astronomers. The earliest mention of amateur astrophotography was probably '*Astronomy with a Small Camera*' in the September, 1893 issue. Soon, magazines devoted to amateur astronomy such as *Sky and Telescope* beginning in 1941 also carried specific columns devoted to amateur telescope making with contributions from amateur astronomers. At first, most of the articles dealt with telescope construction, but once enough telescopes were in operation in backyards across the United States, and spurred on by the advent of the Space Age in the late-1950s, attaching cameras to telescopes or to eyepieces became the next challenge, and amateur astrophotography came into its own. Along the way, astrophotographers had to deal with the movement of objects due to the diurnal rotation of Earth, but this problem had been solved as far back as 1930 by designs for clock-drive mechanisms suitable for small telescopes published in such journals as the *Journal of the British Astronomical Association*.

Like astronomers, amateur astronomers are captivated by the night sky and what they can glean from carefully looking among the star clouds. For those of us that have caught this spirit of adventure, we are compelled to give it as much fodder as we can. We might start out with simple naked-eye observing and quickly move on to using binoculars or building our own telescopes just to see fainter details in whatever we can find in the sky. This leads to learning about constellations, the basic properties of planets and stars, and looking for specific 'deep sky' objects. Some amateur astronomers choose to be satisfied by what they can see through their eyepieces under dark sky conditions. Others decide to learn how to photograph and document what they have found by steadily mastering the methods of astrophotography. Thanks to the accelerated evolution of smartphones for low-light photography, just about every phone bought after 2015 can produce spectacular images of the moon, planets and star clusters among many other targets. Although some cameras do not perform very well taking photographs of the sky without telescopic help,

they can nevertheless perform very well if you just place them behind the eyepiece of a modest-sized telescope or even a pair of binoculars.

In many ways, the fun of astrophotography is akin to hunting for a rare bird or butterfly. Some practitioners are compelled to delve deeply into the technical intricacies of creating the perfect image of the moon, or the Orion Nebula. Others enjoy the simple pleasure of working within the limitations of their telescope and camera to create personal galleries of their best shots. You eventually find yourself hunting for a glimpse of a faint nebula or galaxy, and then challenging yourself to photograph it and its subtle colorations as well as possible for your private collection, or to share with family and friends. The truth of the matter is that much of astrophotography is conducted by solitary participants working in their backyards or at a remote dark sky location. It is often the case that your closest family members and friends will not really understand your hobby beyond the occasional photograph you show them, or anecdote you tell them about the observing circumstances. But some of the most fun you can have will be to share your photographic successes with other like-minded colleagues.

This book could not have been attempted without the amazing contributions by actual smartphone astrophotographers who allowed me to use their works in this book so that you can be inspired to try this activity yourself. The list of contributors shown below is a long one and I am grateful to each of them for the images they provided, many through the Facebook group *Smartphone Astronomy*. All other figures in this book are ones that I created unless otherwise credited.

Viktor Abelin	Stefan Gruber	Mir Oslov
Joe Adlhoch	Christian Harris	Alexander Parmington
Walter Apollonio	Pat Heys	Christine Phares
Michael Armentrout	Billy Heather	Clive Nicholson
Barel Azimtai	Drew Henry	Jim Preusse
Geoffrey Baker	Robert Hite	Marius Reitz
Loren Ball	Zach Honig	Giovanni Fabio Salerno
Chris Barkley	Joey Hunter	Elad Schwartz
Deborah Bonser	Ashley Irons	Doug Shelley
Jim Bonser	Grainge Jennings	Mathew Shields
Christian Buil	Justine Claire Jones	Guy Shimon
Matthijs Burgmeijer	Christopher Jones	Claus Sorenson
Thomas-Juliana Campbell	Stacey Jones	Keith Stanley
Jeff Charles	Florian Kainz	Julie Straayer
Gabriel Clark	Stanislov Kaniansky	Jason Stromback
Roger Clark	Bhushan Karmarkar	Luke Smith
Spencer Collins	Tony Karp	Wilfred Susaya
David Cortner	Jussi Laasonen	Dave Trott
Elizabeth Crossman	Nerida Langcake	Johnny Taylor
Stuart Davis	Drew Langford	Tom Urbain
Scott Dearing	Rocco Lico	Chris Vaughn
Jean-Marie Delaporte	Oscar Lithgow	Michael Seeboerger-Weichselbaum
Peter Deller	Andrew Lomax	Armand Wiersema
Tim Dillon	Elisabeth Macdonald	Rob Wood
Michael Dooley	Jason Melquist	Sean Wood
Luis Delgado Gallardo	Michael Murphy	Chris Woodcock
Paul Gibbs	Logan Nicholson	Shun-Chia Yang
Rory Griffin	Donald Noor	
Robert Grögler	Daryl Olszski	

How to use this book

Astrophotography is a vast and deep subject that requires many different skills and knowledge basis in order for the practitioner to be successful. Just as a teaser, Chapter 17 is a gallery of dramatic photographs from many NASA missions, which serve as an inspiration for how these astronomical objects look with research-grade cameras. In addition to some spectacular images, I also provide some discussion of the kinds of camera systems and imagers that were used. Many of the images were produced by modest 1-megapixel or 5-megapixel arrays, but don't let their seemingly small sizes fool you. These arrays are super-sensitive, have large pixel areas for improved sensitivity, and much lower noise levels than any digital camera system you could buy. Also, they have to be flight-qualified for the harsh radiation, temperature and vacuum conditions in which they have to operate with no human intervention. Many have to remain dormant for 10 years before they are turned on at the end of their journeys to the outer planets. Also provided in this chapter are some of the missions and the URLs to get to their image galleries where you can peruse many more amazing images.

This Guide only touches the surface of presenting this astrophotography information in a handy 'one-stop' format. Fortunately, it is not necessary to accumulate all of these skills before you set out to take your first picture. To use this Guide, first consider whether you have a knowledge base that puts you in the Beginner, Intermediate or Advanced categories. Here's how to figure out which one you are:

Beginner would be someone who has a smartphone and has taken pictures with it, but leaves all of the issues of exposure speed and other factors entirely up to the automatic mode of the camera to sort out. You may also have some knowledge of astronomy, can pick out a few constellations in the night sky, and know the basic definitions for terms such as star cluster, nebulae, planet, asteroid, comet and so on. You have never used your smartphone to take night-time sky photos but have heard a lot about doing this and are intrigued by photos of the Milky Way you have seen in the latest smartphone camera advertisements.

Intermediate practitioners are comfortable with the content of a Beginner, but you are very familiar with using your smartphone in the manual mode where you can adjust the exposure speed and ISO speed for your pictures. You know how to manually focus your smartphone camera. You know perhaps a dozen or more constellations, are familiar with the stellar apparent magnitude brightness scale, and have a number of favorite astronomical objects that are not planets such as the Orion Nebula, the Andromeda Galaxy or the Hercules star cluster Messier-13. You probably own a telescope or have access to one. As for astrophotography, you have not attempted very many of these projects but have always wanted to use your telescope in this way.

Advanced practitioners have operated at the Intermediate level for many years and have moved on to highly-demanding techniques for creating the perfect picture of astronomical objects especially the moon, planets, nebulae and galaxies. You are well-aware of advanced techniques involving flat-fielding, bias and dark frame-subtraction from other camera technologies but are

unfamiliar with how smartphone cameras perform or can be used in this way. You have a good understanding of the underlying mathematics of image processing, and you also have a good idea about how digital array systems operate as electronic and light-sensitive devices.

OK, now that you have a good idea of where you fit-in as an astrophotographer, here is an outline of which chapters and sections in this Guide you should have a look at.

Beginner: Congratulations! You are in for some very exciting ‘firsts’ in your life as you start to master the basics. First, have a look at Chapter 1 that discusses light pollution. Then read through Chapter 2 that discusses basic camera operation. Read Section 2.3, which discusses how camera imaging sensors work but don’t worry about the quantum details of how photodiodes work. Skip Chapter 3 and jump to Chapter 4 to read about which kinds of smartphones work well for astrophotography. Also read Chapter 5 that describes the many apps available that make your smartphone more suitable for astrophotography. These are mostly camera apps that provide you with manual control of the exposure speed and ISO ‘film speed.’

Now that you have a smartphone and have downloaded an app that lets you manually control it, Chapter 6 discusses the kinds of equipment you will need to get started. Star field photography is the easiest because all you need is a tripod and a camera adaptor. Once you have this basic equipment you can get started right away with photographing the constellations by reading Chapter 7 about starfield photography. Just attach your smartphone to the tripod, set your camera up for a 5-second delay (to avoid shaking the camera) and set the exposure to 10 seconds and an ISO of 400. Point the camera at your favorite constellation and take a shot! Subsequent chapters introduce you to photographing through a telescope eyepiece and give an extensive number of examples showing how to take photos of many different objects from the sun and moon, solar eclipses, aurora and even rainbows and sundogs too. After you have carried out a lot of photography at this level, you are now ready to advance to the Intermediate level.

Intermediate: Time to take a step up! Skim-read Chapter 1 about light pollution and read Chapter 2 to get familiar with the basic terminology of photography including f/stops, aperture, ISO and exposure speed. Section 2.3 discusses how photodiodes work and sets you up in Section 2.5 for understanding what electronic noise is all about, so read this section carefully. Skip Chapters 3, which is for Advanced practitioners, and jump to Chapter 4 to read about which kinds of smartphones work well for astrophotography, and read Chapter 5 to become familiar with the kinds of apps available to let you manually control your camera settings. Read Chapter 6 and consider purchasing a camera tripod and the required smartphone adaptors so that you can take high-quality constellation and through-the-eyepiece images. At this point you can skim-read the remaining chapters to see the kinds of images that other astrophotographers have produced with their smartphones. Although a few subjects such as deep sky objects require advanced techniques, the majority of the objects in this book can be photographed using the skills you have acquired at this level. Many of the newer smartphones have low-light capabilities and apps that let you create time-exposure and star-trail images even without knowing what they are doing. Experiment with

these camera functions and create your own images of the Milky Way in the sky, and time-lapse movies of the rotating sky that will impress your grandmother. It may take you a long time, years in fact, to exhaust the subject matter and the techniques you will use especially in long-duration constellation photography to create deep views of the starry sky. You will also spend time shooting through telescope eyepieces to capture lunar mountains, craters and features on Mars and other planets. All the while, you will get better and better at setting your smartphone up for taking images of increasing beauty.

Advanced: Lucky you! Most of the content in Chapters 1 and 2 is old hat and you can skip these chapters or skim-read them. You should begin at Chapter 3, which is all about the theory behind the advanced image techniques of flat-fielding, bias and dark current-correction, so read this chapter carefully. Because you may be unfamiliar with smartphones as astrocameras, read Chapters 4 and 5 to learn about the capabilities of various smartphone models and the kinds of apps available to let you manually control camera settings. You may find the information in the subsequent chapters of interest, and if you have a telescope, there are many possibilities open to you. Since you have a working knowledge of Chapter 3 that covered advanced imaging techniques, you are well on your way to using your smartphone to capture deep sky objects and other astronomical targets. You may also want to join some of the Facebook groups or Citizen Science projects listed in Chapter 18 and 19.

1.0 Light Pollution

As for the real estate industry, location is a huge factor in successful astrophotography. The problem we have faced since the turn of the 20th century is encroaching electrical street lights, which causes what is now called ‘light pollution’. This is a real ‘thing’ because as more and more wasteful lights are used with the spreading urbanization of humans, so too will we diminish the places where you can actually see the Milky Way at night.



Figure 1. Map of light pollution (Credit Google / NASA)

Have a look at this recent map of the continental United States that shows areas of the worst light pollution. You can even use the Google maps feature (Night Photography Workshop, 2020) to check out your own area, and yes there is an app for that - several in fact. For example, on Android phones there is *Light Pollution Map* and *Dark Sky Map*, and on iOS phones there is *Dark Sky*.

The NASA Goddard Space Flight Center where I work is located in the Washington DC light bubble, which is one of many interconnected locations east of the Appalachian Mountains where light pollution is severe. However, there are some locations that are much better than others, you just have to drive an hour or so to get to them. In other locations west of the Appalachians, you folks have it made! Your backyard sky views would be to die for by people living on the East

Coast! But if you look closely, even on the East Coast there are places nearly as dark as what you find in the mid-west or southwest. Here, for example, is a light pollution map of the Washington DC area.

I live in the Bethesda area which is heavily light-polluted, but I can drive one hour north to Whites Ferry along the Potomac River and get to a rural farming area where the light pollution is substantially lower. You can see this little pocket of dark-seeing in Figure 2 within the red ring near the cities of Leesburg, Gaithersburg, and Frederick.

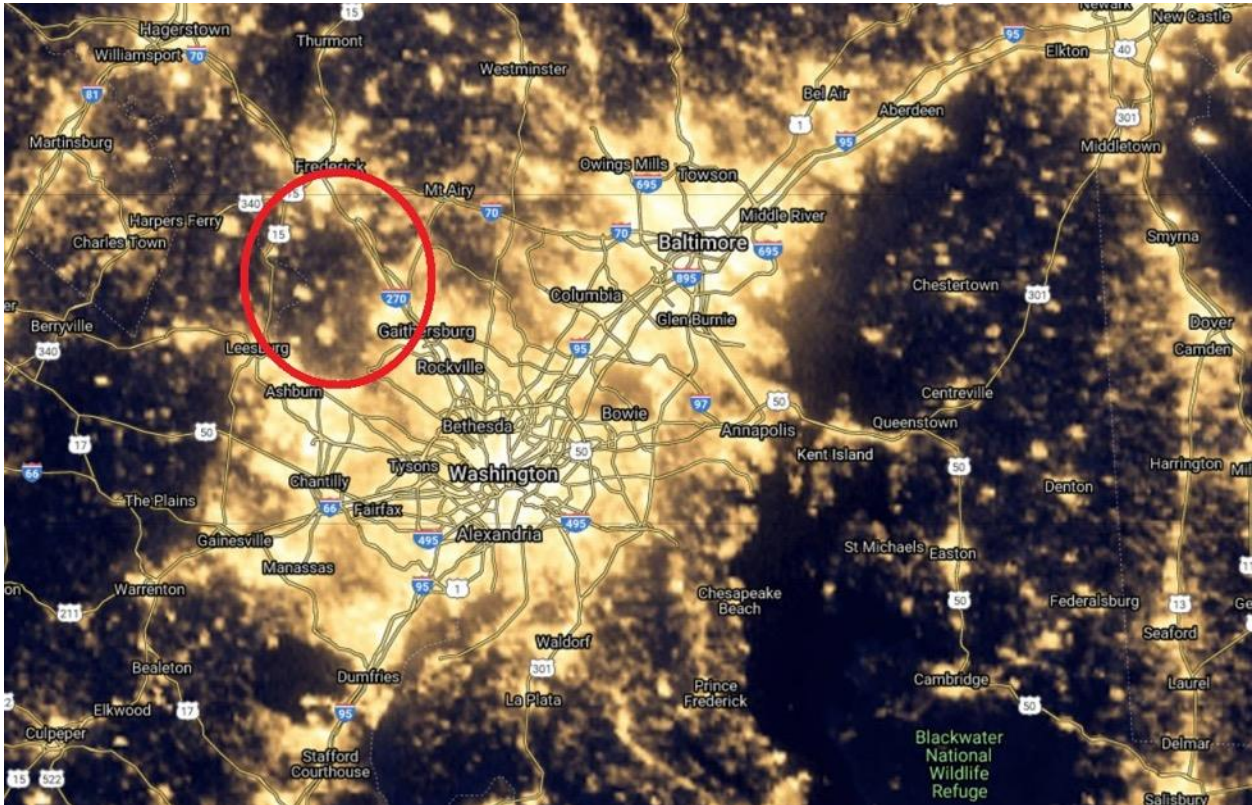

Figure 2. Light pollution map from the Blue Marble site, which uses the data from the NOAA Earth Observation Group and Google. (Credit Blue Marble/NASA/NOAA)

The amount of light pollution is measured in various ways. One way is to compare what you see with the naked eye to a set of constellation charts at different limiting magnitudes. You then match up the chart that looks most like the number of stars you are seeing. This is the approach taken by the citizen science program *Globe at Night*. Another way is to use a specially-designed light meter that costs about \$100 by Unihedron. It directly measures the sky light conditions in terms of magnitudes per square arcsecond (mpsas). This *Sky Quality Meter* (SQM) metering method is used by the International Dark Sky Association. All you do is point the meter at the sky

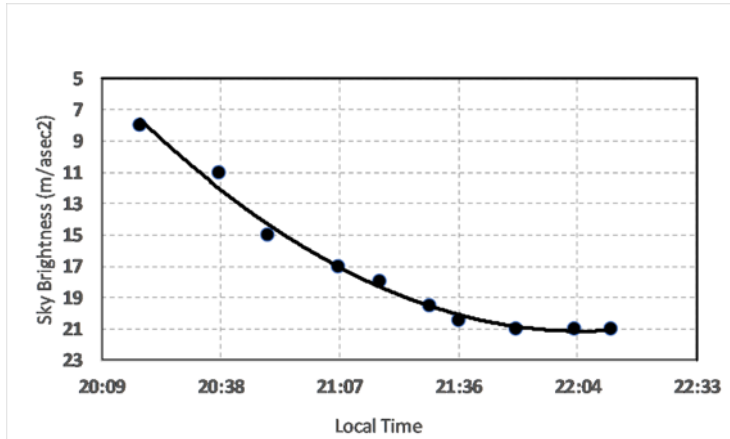

Figure 3. It takes a while for stray sunlight to subside so the later you go out, the better are the conditions. In urban locations, your conditions may get ‘struck’ at 18 mpsas for the rest of the night, but if you are willing to travel for an hour, this plateau can be lowered considerably.

Even now outside my front door in suburban Maryland, conditions rarely get better than about 18 mpsas so that only the brightest stars in Orion or Ursa Major are visible to the eye. But with smartphone astrophotography and a little patience, even these conditions can be defeated to reveal stars not viewable to the naked eye. This book will show you some of the possibilities.

above your head, push a button, and it measures the light emission directly – no charts or guesswork needed. Don’t be discouraged if you can’t travel to a dark site near you. If you are not demanding too much from the experience of astrophotography, you can still have fun. With a telescope, the moon looks spectacular no matter what the level of light pollution on a cloud-free sky.

My initial attempts at constellation astrophotography were conducted from an urban location where the level was close to 17 mpsas.



Figure 4. Left) One of the first surviving pictures ever taken of the moon by Dr. J. W. Draper of New York, 1840 using his 15-inch telescope. (J. W. Draper—London Stereoscopic Company/Getty Images). Right) A modern photograph taken with an 8-inch telescope and an **iPhone 11Pro**. (Credit Rob Wood). Draper’s 15-inch should have had twice the ability to resolve details on the moon but the photographic process was too primitive to make such an accurate reproduction.

2.0 Cameras

The first cameras were little more than glass plates slathered with a chemical and quickly placed behind a large lens in an early-1880s process called the daguerreotype. The first image of the moon was taken this way by astronomer Henry Draper using a small 15-inch (381-cm) telescope in 1840.

Cameras are devices that allow light from an object or scenery to pass through a lens and be focused upon a recording medium. Light is a flow of particles called photons generated by the subject of the photograph often by reflected light from another source. Think of these flows of particles as a firehose directed at a bucket. The brighter the scenery, the more intense is the flow of particles, which is called its intensity or illuminance, the faster the bucket will fill up. When the bucket is completely full, the water will spill over and in photography we say that the recording medium has become ‘saturated’. The goal of the photographer is to control how many photons reach the recording medium (film or digital sensor array) so that the subject is not saturated and preserves its details in an artistically-attractive manner. There are four basic factors that control this process, which can be adjusted by the photographer: Aperture size, exposure speed, f-stop and ISO. In what follows, I will discuss these concepts strictly in terms of digital rather than film photography.



Figure 5. A graphic history of film and digital cameras. Left to right: Brownie Box Camera ca 1900; Exa ca 1951; Instamatic ca 1963; Polaroid SX70 ca 1972; CyberShot 1996; Smartphones 2019.

2.1 Basic Definitions

The relationship between exposure speed, f/number (i.e. aperture) and ISO is called the ‘exposure triangle’ by photographers, which can be represented symbolically by the formula:

$$Exposure = \frac{ISO}{f^2} (Exposure\ speed)$$

Combinations of exposure speed, f/number, and ISO that give the same ‘exposure’ yield images that look the same in terms of their illumination. Here’s how the relationship works. If you have a camera set at $f/2$, $ISO=400$ and use an exposure time of 10 seconds, the exposure $(400 \times 10/2^2)=1000$ will be the same as if you used a slower $f/4$ lens, an ISO of 400, and an exposure time of 40 seconds $(400 \times 40/4^2)=1000$. Because the f/number of a smartphone is generally fixed at $f/2$, the exposure relation only involves ISO and exposure speed so if you double the value of one and halve the value of the other you get the same exposure and image quality.

2.2 Spectral Response

The color of the light striking the camera sensor is also an important factor. Most cameras are designed to mimic the behavior of the human retina in terms of their spectral response. They have poor sensitivity to very blue (shorter than 400 nm) or very red light (longer than 650 nm).

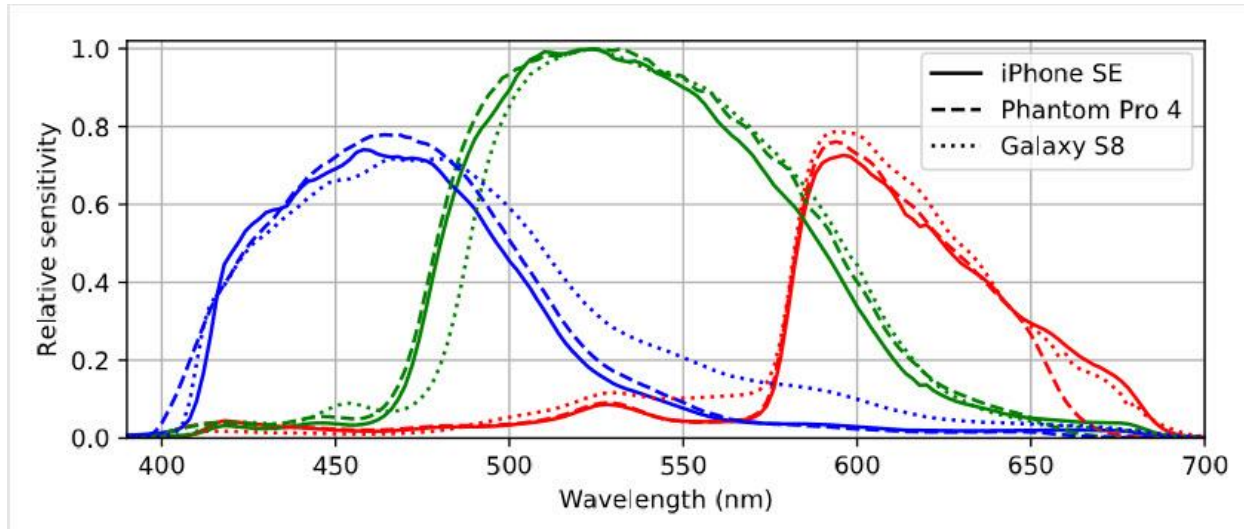

Figure 6. Spectral response of some common smartphone sensors. While most cameras have very similar spectral response curves there are some differences that can influence how the cameras sense and reproduce colors, even when imaging the exact same scene. (Courtesy of Olivier Burggraaff/OSA Publishing)

Some of the best phones for astrophotography allow for extended detection of red light. Since nebulae and most stars emit copious quantities of red light, these phones maximize the amount of light they can detect. To see if your phone does this, take a TV remote control, which uses far-red LEDs, and point it at your phone camera lens, then look at the real-time image. If you can see the remote control's red light brightly, then your camera does have some extended red sensitivity.

2.3 Camera Sensors and Pixels - How They Work

Photodiodes are semiconductor devices that can absorb photons and generate a current of electrons (and holes!) that produce a voltage difference within the connected circuit. The voltage is directly proportional to the number of photons striking the device.

Because of quantum mechanical effects, electrons can tunnel across the energy barrier between the N and P-type regions to produce what is called a dark current. This current is fixed and independent of the device's temperature or the level of the incident light. During an exposure to take an image, this dark current flows and creates its own population of electrons in the photodiode that cannot be distinguished from the photons created by an actual external scene. For astrophotography, this dark current contribution has to be subtracted in order to get an accurate image of the particular object being observed.

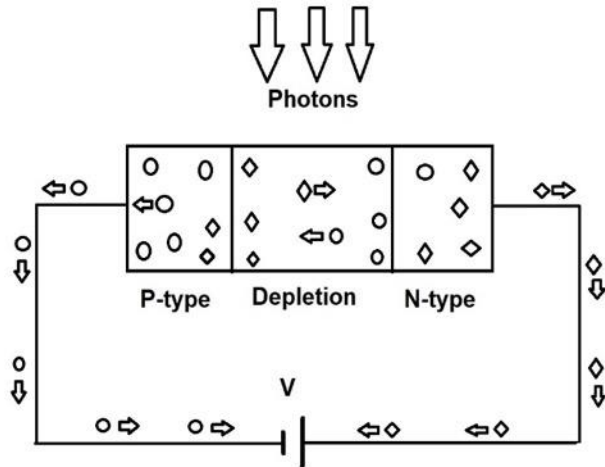

Figure 7. How a photodiode operates. Light photons strike the semiconductor junction (depletion region) and cause electrons (diamonds) and holes (circles) to be created and flow in a circuit. Note that positive charges repel negative charges so that the negative N-type region is rich in electrons and is attracting the positive (diamonds) in the depletion region while the reverse is true for the P-type region. The photons generate electrons (diamonds) in the depletion region which flow to the oppositely-charged side of the depletion region boundary with the N-type region and continue in the circuit to the positive side of the battery. An opposite flow occurs for the holes (circles). This current flow produces a voltage that is proportional to the number of incident photons.

Smartphone image sensors have digital circuitry next to each photodiode ‘pixel’ (shown in Figure 8 in yellow) that converts the light intensity striking the pixel to an analog voltage. Additional circuitry on the chip converts that voltage to a digital value.

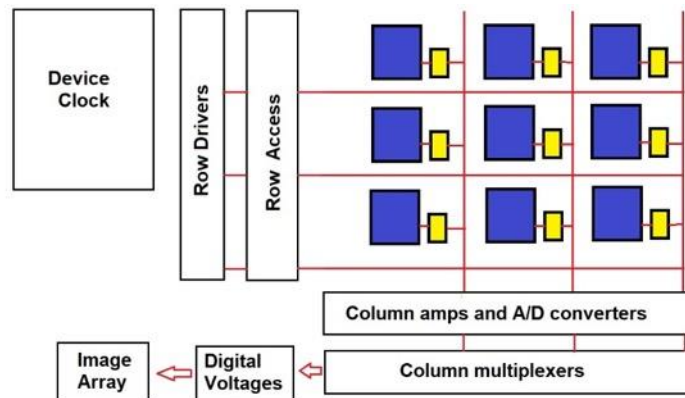

Figure 8. The general layout of a smartphone camera array. The photodiodes (blue squares) convert the photons into electrons. The diode amplifiers (yellow squares) convert the electrons into voltages. The device clock sequences the row and column pixel voltage readouts, which are passed to analog-to-digital (A/D) converters and then multiplexed into a string of digital values that then form the image array. Note that groups of 2x2 contiguous photodiodes form a single image pixel but where each photodiode is filtered to respond to only red, blue or green light.

Smartphones do not simply detect the photons striking the sensor array. Because color photography is the standard goal, the numbers of photons transmitted to the sensor at the red, green and blue wavelengths are determined by using RGB filters. Instead of taking three separate photos and combining them to get the color image, smartphone cameras only need to take one photo because each pixel is actually four pixels, each sensitive to specific R, G or B wavelength.

The light from a source passes through a lens, then passes through a filter that presents the array of pixels with a 2x2 patch containing 1 red, 2 green and 1 blue-sensitive filters called a Bayer mask.

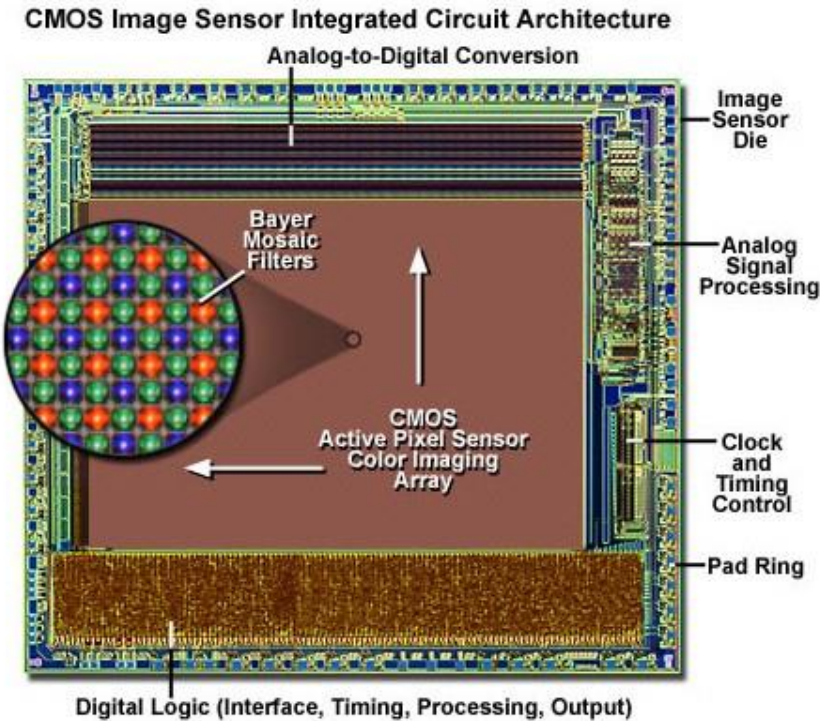

Figure 9. A smartphone camera sensor array. (Credit Molecular Expressions.com at Florida State University)

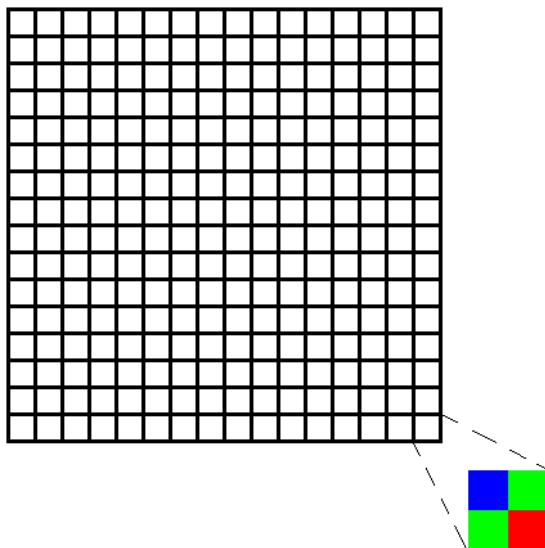

Figure 10. Diagram showing the pixels in a sensor in which a 2x2 RGB Bayer mask underlays each image pixel.

Each of these 2x2 pixel arrays represents one image 'pixel' to provide the image processor with the information to recover the RGB color of the image pixel. The processor then combines the information from the red, green, and blue-sensitive pixels to create a color image.

The lens is typically about 2 millimeters in diameter, and the Bayer filter mask and array are both about 1/4 to 1/3-inch (3 to 5 millimeters) in size.

Because the physical size of the sensor changes very little from generation to generation, the increased megapixel size of cameras has to do with the pixel sizes being made smaller. Current 13-megapixel cameras have pixels only slightly more than 1 micron across. Previous generations of 8-megapixel arrays used 1.4-micron pixels. Will pixels get smaller than this? Probably not. The wavelength of red light is about 0.7 microns so current micron-sized pixels only allow 1 to 2 waves of light to cross their dimensions. For the shorter-wavelength blue light, we are already at 1 wavelength of light, and this is the physical limit of light sensor technology. From now on, it is the physical size of the array that will increase.

By the way, the use of 'megapixel' numbers to describe arrays comes from the product of the pixel width and height of the array, but there is an ambiguity over whether you

mean the actual array chip or the smaller number of image pixels after the array has been Bayer filter-binned to create the final image. For example, if the array has 4 million pixels, each with its own RGB filter, the final image will have only 1 million pixels. Fortunately, powerful software running in the camera's CPU can actually use the Bayer color grid information to figure out or 'de-mosaic' the data and estimate the full color value for each pixel in the sensor array! The end result is that the camera's resolution is better than one would expect if each 2x2 block containing all three colors represented a pixel, but not quite as good as each individual pixel. The real-world resolution limit of a Bayer array is typically around 1.5-times as large as the individual pixels.

Smartphones come with two imaging chips called the front camera and back camera. The front camera faces you when you are using the smartphone display and is good for 'selfies'. The back camera is on the opposite side of the smartphone from the main screen and is used for higher-quality images. These cameras are slightly different. For example, the iPhone 6s has a front camera with 1.2-megapixels (f/2.2) and a back camera with 12-megapixels (f/2.2 and 1.22-micron pixels). In other respects, they are photometrically identical. The Google Pixel camera, meanwhile, has a 8-megapixel front camera (f/2.4 and 1.4 μm pixels) while the 12.3-megapixel back camera (f/2.0 and 1.55 μm) is a faster camera with larger pixels. (see Anantech, 2020)



Figure 11. Early morning image taken at ISO 320 (left) and ISO 1600 (right) with a Nikon 3000DS DSLR camera showing digital noise.

There are typically two ways in which a photograph can be produced that are of interest to astrophotographers. The first is to simply rely on the camera's exposure speed and ISO settings to

produce a single image, which is the final photograph of the astronomical object. This method will be limited by a number of factors. For instance, if the exposure is ‘too long’ the object will move and blur the image. If the ISO value is set too high, you will see the smooth sky and features of the object under low-light conditions break up into a grainy patina due to the discrete nature of photons and the noise in the camera electronics. Image pixelization is caused by the individual pixels in a camera and can be seen when the raw image is greatly magnified, while digital noise is caused by electronics issues or the arrival of individual photons on the array and can be seen as salt-and-pepper speckling in the dark, shadowed areas of a picture. These single-photo images lead to final results that can be very disappointing for their artistic value as Figure 11 shows. For the long exposures required in astrophotography, a lot can happen in an exposure lasting many minutes...or even hours...and any one of these issues can ruin a photo shoot (e.g. camera accidentally shaken or a jet flying through the field).

Astronomers have been using digital single-lens reflex (DLSR) cameras since the 1960s and have developed powerful techniques for creating scientifically-accurate and beautiful images of very faint objects across the universe. The scientific accuracy is guaranteed because the values stored in each pixel of the image are directly related to the number of electrons produced in that pixel by the photons of the impinging light. Astronomers want to measure this real brightness accurately to do precision photometry so you can’t play around with the image just to make it look beautiful. These image files are typically very large because professional digital photos can have 10 or 100 times the number of pixels compared to commercial smartphone cameras. Processing of these images is performed using highly-accurate programs such as IDL where the arrays of numbers forming an image can be algebraically manipulated using carefully-designed protocols that preserve the integrity of the image data. This is very different than the Joint Photographic Experts Group (jpeg) images that are typically used and exchanged from smartphone picture ‘galleries’ where the pixel values have been manipulated and ‘compressed’ to take up the smallest amount of storage space. For example, a 3024x4032-pixel (12-megapixel) smartphone image with a pixel color depth of 24-bits represents a raw image file of about 36 megabytes but jpeg compression reduces this to about 4 megabytes. The lost information is vital to precision manipulation of the image data.

One solution to this problem of losing valuable data is to use the Tag Image File Format (TIFF), which is uncompressed. However, TIFF files contain more data, so the files are larger than jpeg files by factors of 2 to 3. TIFF records all 16-bits in the RGB color channels which is why the files are so big. RAW files are also uncompressed and are the digital equivalent of photographic film. The image data is saved in monochrome, one complete image for each of the three colors, which is why they are so much smaller than TIFFs but contain as much information. The benefit of this RAW format is that you can adjust image contrast, saturation, sharpness, white balance, and other attributes without degrading the image. Afterwards, it can be saved to another image format like TIFF or JPEG. You will probably start out using JPEG images and using *Photoshop*

to process them, but as you get better and more demanding you are likely to want to use RAW image data.

2.4 The basic camera mechanism and controllable factors

2.4.1 Aperture size

Using a firehose analogy, the bigger the bucket, the more water it can store. For cameras, the larger the aperture, the more light it will allow to enter and be focused on the array. All other things being equal, when you are working under low illumination levels, you want to use the largest aperture lens (or mirror) that you can buy! The area of the aperture is directly related to the number of photons of light that can be captured. This is why astronomers use the largest telescopes they can afford or can build to capture light from distant objects.

The human eye, when dark-adapted for faint illumination, has a pupil aperture of about 7.5 mm in diameter when you are young and 5 mm when you are old. Because the amount of light that can be gathered per unit time varies as the area of the aperture, this means that when you were young, your eyes admitted about $(7.5/5)^2 = 3.5$ -times more light under dark-adapted conditions. This is why most people older than about 30 years of age have a bit more difficulty seeing well under poor illumination. Because smartphones are designed to photographically mimic what the human eye sees, smartphone lenses are typically about 4 mm in diameter.



Figure 12. Camera for an iPhone 5s showing diameter of the entrance aperture (lens) which is typically about 4 mm across. (Credit Joshua Waller Ephotozine)

Aperture also determines how well an optical system can resolve two objects far away as being in fact two separate but close-by objects. Called the angular resolution or visual acuity, astronomers measure this in units of arcseconds where 1 angular degree equals 3600 arcseconds (i.e. 60 arcminutes per degree times 60 arcseconds per arcminute). An alternative measure is the radian for which 1 radian equals 57.3 degrees. This feature is wavelength-dependent because longer wavelength light is ‘fatter’ and so can only tell you about details larger than they are. The specific formula is just $\theta = 1.22 \lambda/D$ where λ is the wavelength in meters and D is the aperture diameter in meters. The answer will be in radians. For example, in the visible spectrum, $\lambda = 500\text{nm}$ (5.0×10^{-7} meters), and the human eye has a pupil diameter of $D = 5 \text{ mm}$ (0.005 meters), so by the formula, $\theta = 0.00012$ radians. Because 1 radian equals 57.3 degrees or 206265 arcseconds, $\theta = 25$ arcseconds.

Smartphone displays are often marketed as retinal-resolution, which means that holding your smartphone at a comfortable distance from your eye, the pixels in the display screen are

physically small enough to display features as close together as 25 arcseconds when dark-adapted, but in normal daylight with a 2 mm pupil it is about 60 arcseconds or 1/60 of a degree. If you draw two parallel lines 1-cm apart, at a daylight distance of 35 meters (about 100 feet) a normal human eye would just barely see them as separate lines. An eagle, however, could separate them at a distance of 280 meters (800 feet). If you swapped your eyes for an eagle's, you could actually see an ant crawling on the ground from the roof of a 10-story building!



Figure 13. Camera lenses, especially those that involve zoomable focus, have a fixed aperture but can vary the focal length, causing the f /number to vary. Typical 50mm camera lenses have $f/1.8$ as a minimum, but have variable internal diaphragms that can reduce the aperture below 50mm thereby increasing the f /number (allowing less light in and increasing the exposure setting) for a particular photographic shoot. (Credit Canon Corp.)

Two telescopes can have identical f /numbers defined by the objective diameter (e.g. an 8-inch mirror) and the focal length of the objective, but the one with the larger objective will let more light in.



Figure 14. A comparison of two F/6 telescopes to show aperture differences. The 6-inch f/6 reflector on the left and the 30-inch, f/6 reflector at the Stony Ridge Observatory on the right have the same f/numbers, but the 30-inch aperture provides $(30/6)^2 = 25$ - times the light gathering ability and makes faint objects appear not only brighter, but can be resolved $(30/6) = 5$ -times better to show more details. The photo above courtesy Elizabeth Erin Crossman, CSULA.

2.4.2 The F-stop

Intimately related to the aperture is the so-called f-stop or f/number. This number is the ratio of the open diameter of the lens to its focal length. Cameras and lenses are usually graded by this number, with an f/2.2 camera allowing for less light to reach the array than an f/1.2 camera, which would be called a ‘faster’ system. F-stops on a camera are manually set at values of f/1, f/1.4, f/2, f/2.8, f/4, f/5.6, f/8, f/11, f/16, f/22, f/32, etc. One f-stop difference (i.e. between f/2.8 and f/4) represents $\sqrt{2}$ decrease in aperture diameter and so a factor of $(\sqrt{2})^2 = 2$ times reduction in image brightness because the area of the exposed lens is now $\frac{1}{2}$ as large. When the camera is ‘wide open’ at f/1, it is allowing $16^2 = 256$ -times more light onto the film or array than at a setting of f/16.

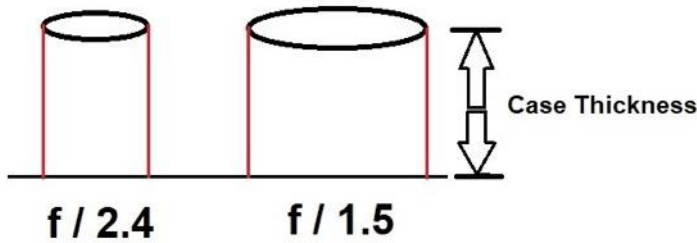

Figure 15. Comparison of light entering lenses with different f-numbers due to the fixed thickness of the smartphone cases.

allow you to vary the f-stop of the camera, smartphones have a fixed aperture and f-stop due to the severe restrictions on how big the camera can be, in particular the thickness of the case. A typical lens is only 4 mm in diameter and the smartphone case is only about 10 mm thick, so f-values near 2 are the fastest possible unless one uses a larger lens size.

For example, a 2 mm diameter lens with a focal length of 6 mm has an f/number of $6/2 = 3.0$ so f/3.0 is the ‘fastest’ speed the lens can support with its aperture fully opened. If I reduced the diameter by a factor of 2 to 1 mm with the same focal length, the lens now has f/6.0 which photographers would call a slower setting because less light (only $(3/6)^2 = 1/4$) gets through to the array. Older smartphone cameras have a fixed f/number of typically 2.2, but modern, faster cameras with f/1.7 and even f/1.5 are becoming available. The f/number also defines the maximum

angular field-of-view (FOV) of the camera. Here’s how that works.

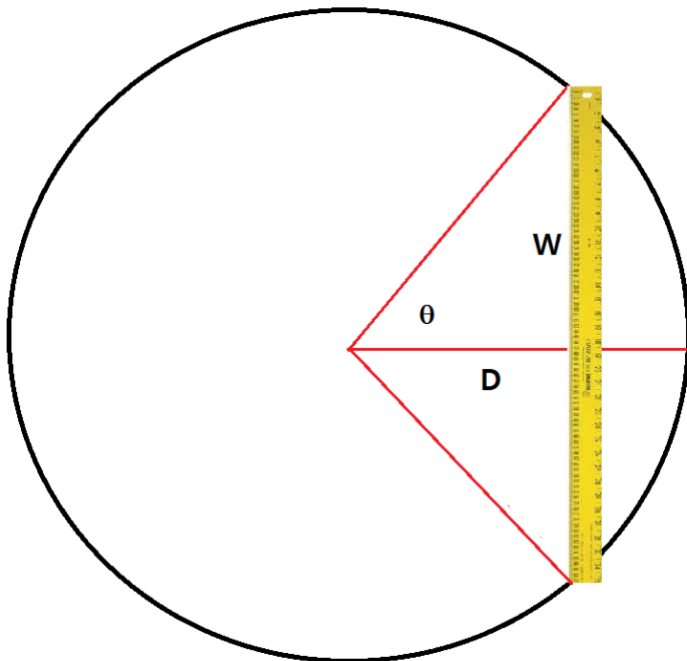

Figure 16. Diagram showing the geometry of the field-of-view calculation. The angle θ is found from the tangent of the half-width w divided by the distance between the camera lens and the meter stick, D . The FOV is twice this angle.

angular field-of-view (FOV) of the camera. Here’s how that works. For a lens, the angle of view can be calculated from the chosen dimension in millimeters, and effective focal length in millimeters as follows

$$\theta = 2 \arctan \left(\frac{w}{D} \right)$$

where w represents the half-width of the film (or sensor) in the direction measured. For example, an 8-inch telescope designed to operate at f/6.0 (e.g. a $w=100$ -mm mirror and $D=1200$ -mm focal length) has an FOV of 9.5° . In general, this entire FOV is not available for imaging at the focal plane of a telescope due to the

insertion of various field stops and supporting structure. For instance, if you place an eyepiece at the focus, the FOV is now restricted by only those rays that can pass through the barrel of the eyepiece. To figure out the eyepiece FOV without the telescope, called the apparent FOV (aFOV), this number is usually provided by the manufacturer. For example, a Plössl eyepiece can have a 52° aFOV, but the image is of course unfocussed until you put the eyepiece in a telescope. The true FOV (tFOV) is then just aFOV/M where M is the magnification of the eyepiece in the telescope. This is found by taking the telescope focal length (e.g. 1200 mm) and dividing by the eyepiece focal length (example 7.5 mm) to get $M = 1200/7.5 = 160x$ so that the tFOV through the eyepiece is then just $tFOV = 52/160 = 0.3^\circ$. In this example, the moon is 0.5° in diameter so the full moon would completely fill the eyepiece at this magnification and on this telescope. If you use your smartphone (say a Galaxy s9) at the eyepiece of the above example, its format of 2960x1440 pixels now has a tFOV of 0.3° ! Here's where you may run into a problem.

Our atmosphere provides at best 1-arcsecond seeing conditions even for most dark locations. Any star images or moon features smaller than this angular size will be noticeably smeared out. If the tFOV of the smartphone is 0.3° spanning 1440 pixels, that corresponds to 1080 arcseconds across 1440 pixels or 0.75 arcseconds/pixel. So under the best seeing conditions, your star images will be no bigger than about one pixel, and so if you magnify the image from the smartphone, your stars will look like little squares in the above telescope+eyepiece example! By using a lower-power eyepiece you can make your tFOV larger and let your star images occupy more than one pixel, which could greatly help in making a 'beautiful' picture that you can enlarge and frame.

Smartphones are challenged to shoot pictures under low light astronomical conditions because first of all as Figure 17 shows, the imaging sensor array (yellow) is so small (and the pixels are even smaller) so fewer photons can reach the detector to get registered above the naturally occurring background and electronic noise levels. Most DSLR cameras have much larger arrays and individual pixels (blue) allowing them to capture and detect 100x or more photons in a single exposure.

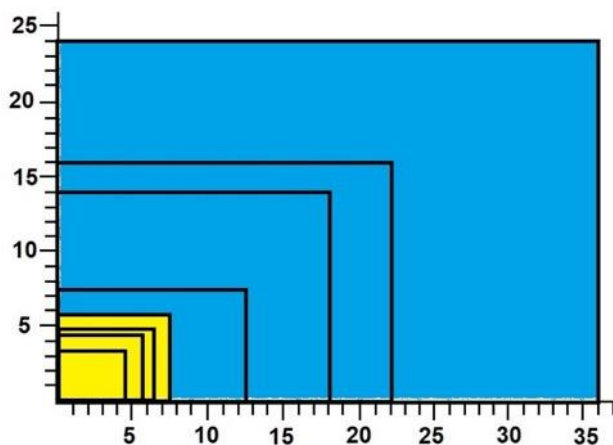

Figure 17. Imaging sensor physical sizes in millimeters: Smartphones (in yellow) iPhone 6, iPhone XS, Xiaomi Redmi Note 7 Pro, Huawei P30 Pro. Digital SLRs (in blue): Super-16mm movie film, Canon PowerShot G1, Standard 35mm film, 35mm full-frame DLSR (e.g. Canon, Nikon, Pentax).

are even smaller) so fewer photons can reach the detector to get registered above the naturally occurring background and electronic noise levels. Most DSLR cameras have much larger arrays and individual pixels (blue) allowing them to capture and detect 100x or more photons in a single exposure.

If you just want to do constellation or 'star field' photography, the situation is even better. To plan your shot you now have to figure out what your smartphone camera FOV is. You can just take a photo of the sky and use a star chart to work this out experimentally!

2.4.3 Exposure speed

Like f-stop, exposure speed is also a rather self-explanatory idea. In old-style cameras, there was a screen that mechanically snapped across the inside of the camera lens, or tilted the mirror out of the way, so that the light falling on the film could be interrupted for times as short as 1/1000 seconds, or for so long as you wanted using the bulb or 'B' setting and a shutter-release cable. Smartphone cameras do this electronically by simply starting and stopping the read-out of the imaging sensor. The particular exposure time you will use for astrophotography depends on many factors having to do with the brightness of the subject matter, but also with a second issue, namely, the movement of the subject across the camera FOV, which is called diurnal motion.



Figure 18. As Earth rotates, from the ground, stars appear to rotate about the north and south celestial poles once every 24 hours (Credit Wikipedia)

Because Earth rotates on its axis from west to east, any object in the sky will slowly move from the east to the west completing a full circuit of the sky (360°) every 24-hours or an angular speed of $15^\circ/\text{hr}$ called the diurnal rate. As Figure 18 shows, for the same time interval, the arc circumference is greatest near the celestial equator and least near the poles. There is also the natural movement of objects across the sky to consider, especially the sun and moon. Against the background stars, the moon travels at a speed of 360° every 28 days, equivalent to $0.5^\circ/\text{hr}$, which is equal to shifting its own diameter every hour. The sun moves 360° every 365 days or $1/24$ of a degree every hour. Orbiting satellites show this intrinsic angular motion the most dramatically and can be seen moving across the twilight sky at a speed of 360° in 90 minutes or $4^\circ/\text{minute}$.

If you want to have images of constellations that do not show the diurnal effect causing the images to elongate into arcs, you need to set your exposure to something under 30 seconds. Longer

exposure times can be used within the circumpolar zone of constellations where the arcs are the shortest, but exposure times less than 30 seconds need to be used for equatorial constellations like Orion. Through trial-and-error you will have to find the exposure time that gives you pinpoint star images, then you can adjust the ISO to improve the faintness of the stars you can detect during this exposure time. In fact, the ‘500 Rule’ is used by many astrophotographers to find the maximum exposure time that does not leave noticeable star trails so that $\text{Time} = 500/\text{FL}$ where FL is the focal length of your smartphone. For example, a smartphone with an equivalent focal length of 35 mm will only let you shoot for about 14 seconds before your stars start to look distorted.

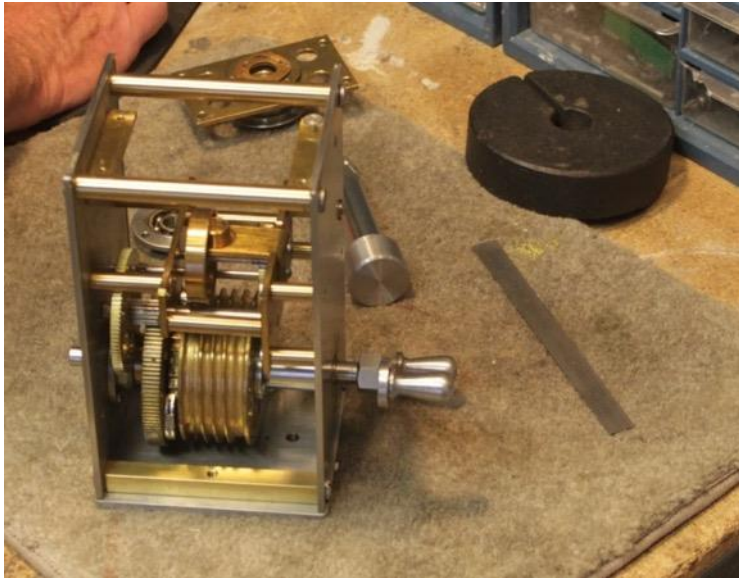

Figure 19. Old-style gear-based clock drive. The input shaft to the telescope was set up to rotate once every 1440 minutes, so that a synchronous motor with a 1 RPM output had to be geared-down to rotate at the diurnal rate. (Credit Dave Trott)

For telescopic viewing, unless you are only photographing the sun and moon that favor very short sub-second exposure times, you will need a ‘clock drive’ to physically move your telescope to follow the stars. When properly set up, you can now take exposures lasting many minutes at a time with no image movement, perfect for capturing the images of faint nebulae and galaxies. Clock drives used to be complex gear-and-motor-based mechanical devices attached to the polar axis of a telescope, but are now based on stepper motors alone that are computer-controlled from second to second.

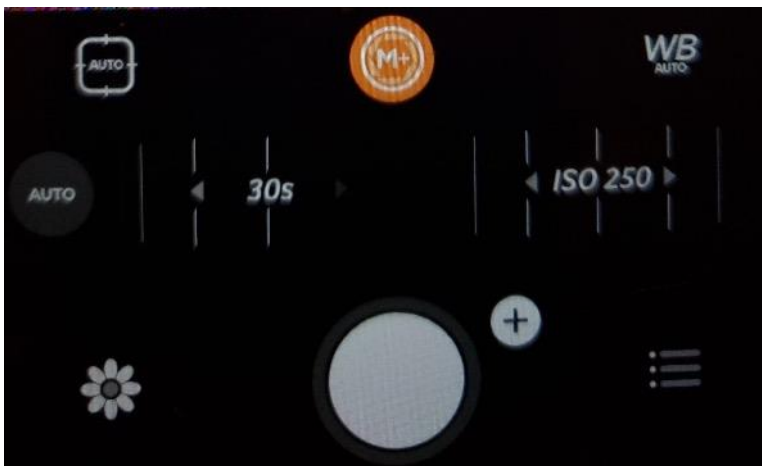

Figure 20. Most camera phones since 2015 are fully-automatic and don't let you alter the exposure settings. However, you can get camera apps that have manual or pro settings, which let you adjust the exposure speed over a wide range. Camera apps such as *Camera+*, *Procam 2*, etc. permit long exposures, and always include a manual mode. The ‘Pro’ mode on *Camera+* shown in this figure lets you select exposures up to 30 seconds and ISO up to 2000 using sliders.

2.4.4 ISO

Although exposure speed and f-stops are easy and intuitive to understand, the concept of ‘ISO’ (ISO = International Standardization Organization) is not quite as accessible. The basic idea is that it is supposed to be a measure of how responsive a particular medium (film or digital array) is to the light falling on it. Photographers often call this the film speed, meaning that when the number is large the film acts ‘faster’ to detect the incoming light. It is supposed to be the reciprocal idea to exposure speed in that, when you select a larger ISO value, you can proportionately shorten the exposure speed and get the same density of grains in the film emulsion, hence higher ISO values correspond to faster films. In some sense, ISO is supposed to be related to an actual physical property of the medium called its quantum efficiency.

Quantum efficiency (QE) is a measure of how efficient a particular medium is in converting photons to electrons. A higher QE number means that the film or digital array is more sensitive to light so that you can take pictures under poor lighting conditions. For some applications it can be a measure of the output current of a material compared to the incident illumination leading to a unit of microamperes per lumen. For other applications it can be the number of emulsion grains of silver that are produced for a given number of photons striking the film’s surface. The rod receptors of the human eye have a QE of nearly 1.0 in that they produce an output response (firings of the associated optic nerve synapse) for each photon striking them.

Typical photographic emulsions have QE values of 0.2%, meaning that one-in-500 photons striking the film emulsion will cause a measurable chemical change, while digital arrays can have QEs as high as 30% so that one-in-three photons are actually detected. For films rated by an ISO number, the ISO value does in fact correspond to the QE of the emulsion in that if Emulsion A has twice the QE of Emulsion B, then it also has twice the ISO value. This is based on the principle that the QE of a medium is a built-in physical property of the medium and cannot be changed, so we can compare them by using either their QE or ISO value. For digital cameras this simple comparison does not work.

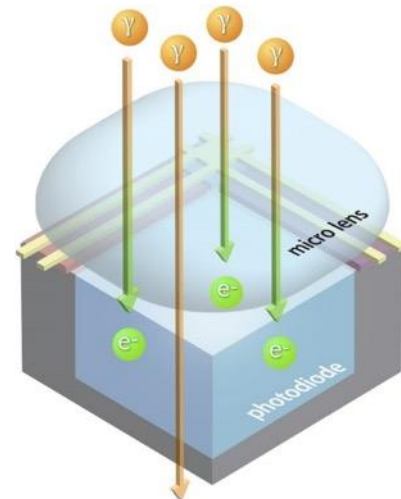

Figure 21. Four photons enter the photodiode and three electrons are generated so the QE of this example is $\frac{3}{4}$ (0.75) or 75% (Credit LUCID Vision Labs, Inc.)

A digital camera has a sensor array with a specific ‘hard-wired’ QE, which is a measure of the number of electrons generated by the incident photons of light that physically strike the imaging sensor. But these electrons, and specifically their currents, have to be amplified in order

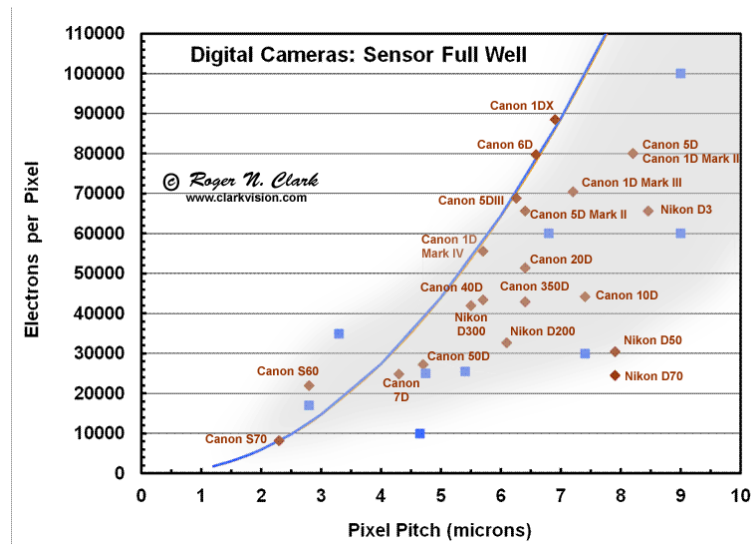

Figure 22. Pixel ‘well capacity’ of some digital camera systems. Smartphones are near the bottom of this curve with 1-2micron pixels! (Credit Roger Clark)

to be detected and rendered into a particular pixel value. This amplification process introduces a gain factor, and it is this gain factor that you change when you vary the ISO value of your camera setting.

If your sensor has a QE of 0.33 so that one electron is generated for every three photons incident, the resulting electron current output value in units of microamperes per lumen may still have a value of, say 0.0035 microamperes/lumen, but the amplification gain can be electronically increased by 1000 so that you get 0.0035 amperes/lumen.

So, the ISO setting is a measure of the electronic gain you are using, but is not a measure of the QE of the sensor, which remains fixed at 0.33. Because the QE is so close to unity, you can think of ISO as multiplying the number of electrons that one photon generates. But if you are interested in doing accurate light measurements like many astronomers do, a system that gives you one electron per photon is the maximum information you can extract from the pixel that can be traced back to the nature of the light source, and anything more is a non-physical amplification effect that has to be factored into the calibration process.

In both digital cameras and film emulsions, a practical limit is reached where even very dim light completely floods each pixel with the maximum number of electrons so the pixel ‘well’ becomes saturated. For photographic films, the film negative turns completely black and opaque. Typical 1-micron-sized pixels in smartphone cameras can only accommodate about 5,000 electrons before they are fully saturated and the pixel turns ‘white’ in the positive image. The larger the pixel size in microns, the larger is the well capacity, which enables higher ISO operation and faint light registry with moderate exposure times. However, most phones only allow you to adjust the ISO to about 800 (e.g. Galaxy S9+ with native camera app) or in some cases 3200 as a maximum limit (e.g. OnePlus 7T Pro). The Huawei 30p however lets you go all the way up to 409,600! Generally, smartphones are capped between ISO values of 800 to 3200 because for most exposure settings the resulting low light image above these values will, according to the manufacturers, be unacceptably grainy for the typical kinds of photography that most people do.

Generally, if you double the ISO value you can halve the exposure speed (or equivalently reduce the f/stop by one stop) and still get the same level of photographic exposure for the amount of illumination in the scene. However, as you increase ISO above 1000 you typically run into another problem and that is the random noise way back in the imaging sensor itself. To understand where this noise comes from, we have to look into the details of how the imaging array works.

2.5 Sources of Noise

At the imaging sensor, the individual pixels are essentially gathering photons and generating electrons in the photodiode at perhaps a rate of one electron per three photons (QE about 0.33). The pixels are only about one micron across, and can generate and hold about 10,000 electrons. From statistics, the randomness of the arriving photon counts goes as $\pm\sqrt{N}$, which is sometimes called the Square-root Law, so this is about ± 100 electrons (or $\pm 1\%$) as the random noise. What this means is that the best the electronics can do is to resolve about $10,000/100 = 100$ levels of brightness change or about 7 or 7-bits of significant change in the photodiode current changes. Anything more than this is just amplifying the noise and not contributing to actual information in the subject of the photograph.

Astronomically, a factor of 100 is exactly $+5^m$ stellar apparent magnitudes, which sets the dynamic range between the brightest and faintest stars you can see in a single shot. For very bright scenes where the photodiodes are working near their capacity this electron noise is not noticeable, but at low light conditions where typical photodiodes are operating at perhaps 500 electrons or less, this noise starts to get worse because now $\sqrt{500}$ is about ± 22 electrons or variations of $\pm 4\%$ in the image smoothness, which can easily be seen in the final photo. Changing the ISO of an image essentially multiplies the currents produced by the electrons by an electronic gain factor, but the sensor is not being made more sensitive to light. All that is accomplished by increasing the ISO is to magnify the photoelectron currents produced by the photodiodes including not only the signal produced by the desired object being photographed but the electron noise as well. Incidentally, the raw image produced by a smartphone or other DSLR that represents the exposed object image is often called the 'Sky' image. It is created by simply taking a photograph of the astronomical subject with the selected aperture, exposure and speed.

In addition to the electron/photon noise, the photodiode as a quantum device has noise caused by the spontaneous quantum tunneling of electrons and by the thermal agitation of the electrons in a warm sensor. This effect causes additional electrons to be added to each pixel as time goes on during an exposure. Called the 'dark current', it amounts to a few tens of electrons per second per pixel. For astrophotography where exposure times of several minutes may be common per image, the accumulated dark current noise can become significant relative to the dynamic range of the sensor. Astrophotographers measure this effect by closing off the camera lens to any external light leaving the array in a fully-dark configuration. An exposure is then made with exactly the same exposure time as the Sky image so that the pixels accumulate the dark electrons to exactly the same degree as in the Sky image. This image is called the 'dark frame'.

In the post-sensor electronics, the photodiodes have to be read-out. This produces what is called read noise and corresponds to a roughly fixed number of electrons each time the image is read out and stored. It is also the case that the array produces fixed patterns of artifacts due to the way in which the array photodiodes were created on the array substrate. This information can be obtained for an image by creating a ‘bias frame’ by closing off the camera so the array is dark, and then shooting at the shortest possible exposure so that there is little dark current contributing. Under these conditions, any systematic shifts between pixels or electronic read noise will show up.

Finally, because of the way that sensors arrays are manufactured, each pixel responds slightly differently to the applied illumination because the QE varies. Astrophotographers measure the contribution of this effect in their Sky image by pointing the camera at a screen that displays a uniform brightness with no gradients or shadows across its surface. At observatories two common sources are the inside of the observatory dome or at a location in the twilight sky just east of zenith. Once the dark and bias components have been corrected, the resulting image contains information about how the QE of each pixel varies across the array. Also included are variations due to the optical distortions in the telescope optics and even dust motes near the camera lens and array. This image is called the ‘flat field’.

3.0 The art of calibration and why it works

The process of calibrating an image involves using the flat field, bias and dark field information to correct the Sky image for these effects.

3.1 But First A bit of Statistics

Think of a digital camera image as a collection of measurements; one for each pixel in the RGB mask. Let’s just consider one of these pixels in a square array noted by its row (x) and column number (y) and call it P_{xy} . So, for example, the pixel located at the intersection of row 135 and column 273 is just $P_{135,273}$. For a single image in either R, G or B, we only have one measured value of the pixel P_{xy} , but if we took five consecutive images, this particular pixel would have the measurements $P_{xy}(1)$, $P_{xy}(2)$, $P_{xy}(3)$, $P_{xy}(4)$ and $P_{xy}(5)$. The term stacking refers to making sure that the images are lined up and shifted if necessary so that, say, $P_{123,456}$ on one image in the ‘stack’ is looking at exactly the same location in the scene as $P_{123,456}$ in all of the other images. Stacking is made very easy in astrophotography because the ‘scene’ called the Sky image consists of stars in fixed patterns in the sky so it is easy to make sure that Betelgeuse and Rigel in the constellation Orion are located in precisely the same two pixels in each image. If this is not the case, the images have to be shifted vertically or horizontally, or even rotated, so that the reference stars always appear in the same pixel addresses in the final stacked image. Once we have aligned and stacked the images, we can now do the next step called co-adding, which means to add up and average the measured pixel values to get a final averaged value for that pixel.

Let's say that the measurements for this 'Betelgeuse' pixel were 245, 250, 243, 295 and 245. What do you notice about this collection? You should see that four of the values are in the range from 243 to 250, but one of them has a value of 295. From statistics, the average value of the four measurements is 246. The most common value, called the mode, is 245, but then we have the outlier value of 295. Should we have included it in the averaging step? We can decide whether we should add or ignore this value by looking at the standard deviation (s.d) of the four measurements. We can calculate the s.d also noted by the Greek letter σ , by using the elementary formula:

$$\sigma = \sqrt{\frac{\sum_1^N (m_i - M)^2}{N - 1}}$$

where N is the number of measurements (i.e. the number of frames we want to coadd), M is the average value of these N measurements, and m_i is the value of each individual measurement. If you use the N=4 measurements 245, 250, 243 and 245 and M=246 you get for the numerator $(245-246)^2 + (250-246)^2 + (243-246)^2 + (245-246)^2 = 27$ so $\sigma = \sqrt{(27/3)} = 3$. What this means is that the four measured values have an average of M=246 but are distributed around this average value such that the measurement uncertainty is ± 3 . If the uncertainty is distributed according to a perfectly random, Gaussian (bell curve) as Figure 23 shows.

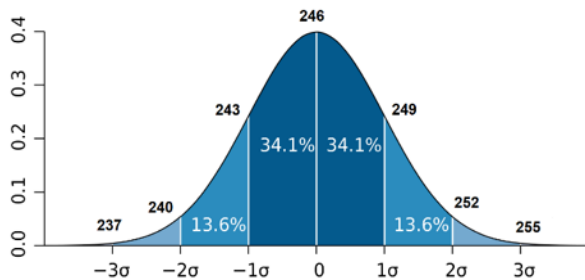

Figure 23. A Gaussian distribution showing the various statistical divisions and frequencies relative to multiples of five pixels, the measurement at 295

(essentially a 16σ value) is an incredibly, if not

impossibly, rare event for a distribution defined by the other four pixel values. We call this measurement an outlier and we are permitted, statistically, to not include it in the sum IF we really believe that the measurement distribution is a random one in which the differences from the average are completely random variations. So, what does this mean for our image processing? It means that we can either drop the entire image containing this pixel from the co-added stack, or we can just mask out this one pixel but still co-add all the other pixels in this image IF they also show their values are consistent with a random-noise or 'Gaussian' distribution.

A quick way to eliminate outliers is to use a process called median filtering. In our above example of five measurements, 245, 250, 243, 295 and 245, place them in rank order from smallest to largest to get 243, 245, 245, 250, 295. Select the value represented by Rank number 3, which is

245. This is the median of the data. By median filtering every pixel across the five images taken, you can eliminate outliers very quickly, resulting in a cleaner image and one whose ‘noise’ more closely resembles a Gaussian random process. That being the case, the final image will obey the Square-Root Law of reducing the noise by increasing the number of images, N , coadded, in other words coadding 100 images will have 1/10 the noise per pixel of a single image.

If our Sky images were perfect, we could just co-add the stacked images and get our final, beautiful, photograph but in fact no sensor is perfect. Imaging arrays, as we learned in the previous section, have gain and noise issues that have to be considered carefully. Let’s do the gain issue first because it’s the easiest to understand.

3.2 Gain Correction and Flat Fielding

If a pixel converts one photon into exactly one electron, its gain is exactly 1.0. The way that this conversion happens is due to what is called the quantum efficiency (QE) of the pixel. But how does a pixel get its ability to convert photons into electrons to define its QE? The answer is that the semiconductor material that the photodiode in the pixel is made from is ‘doped’ with another element. This is done by a process called ion implantation where the semiconductor material is literally blasted with doping ions. The more doping ions there are, the higher is the QE of the material. But because of the way that this process is physically applied across the surface of the array, no two pixels will have exactly the same doping concentration and QE. The values will be very close to an average for that array, but pixel-to-pixel variations will occur. That means that if a fixed number of photons land on the surface every second, the pixels will report slightly different values for the intensity of the light. This causes a blank uniformly-lit scene to show pixelized brightness changes. This effect, which is inherent to all digital cameras can be easily corrected. It is variously called flat-fielding or gain-correction. If your astrophoto ‘Sky’ image is taken with an exposure of 10 seconds at an ISO of 800, you will create a reference flat of a uniform-brightness source at exactly the same exposure and ISO. Astronomers often point their telescopes at the inside of an illuminated observatory dome and take a photo of this. Other possibilities are the twilight sky, where you point your camera at a location in the late-twilight sky just east of zenith (sun sets in the west so this point is farthest from the sun). Other locations in the sky will suffer from a twilight light gradient effect of about 5% change per degree and not provide a uniform illumination of your image (Chromey and Hasselbacher, 1996). You can even use a laptop with a sheet of paper over the screen!

This ‘dome flat’ or ‘twilight flat’ or simply ‘Flat’, F_{xy} , can be converted into a table of the gains for each pixel by simply dividing each number by the average pixel intensity, F , across the entire array to get the pixel gains, $G_{xy} = F_{xy}/F$. To correct the Sky image for these gain changes, all you need to do is divide each Sky pixel intensity by its corresponding gain: $C_{xy} = P_{xy}/G_{xy}$. Here’s how this works.

Suppose you had three pixels in the raw Flat image in column $x=1$ and rows $y=2,3$ and 4 that read $F_{12}=254$, $F_{13}=250$ and $F_{14}=258$ electrons. The average is $F = (254+250+258)/3 = 254$. The corresponding gains are $G_{12}=254/254 = 1.0$, $G_{13}=250/254=0.984$ and $G_{14}=258/254=1.016$. In order to correct the raw Flat image so that all of its pixels correspond to the same gain, you divide the raw values by the gain so that $C_{12} = 254/1.0 = 254$, $C_{13}=250/0.984=254$ and $C_{14}=258/1.016=254$. The fact that all the pixel values will read the same '254' means that you have successfully created

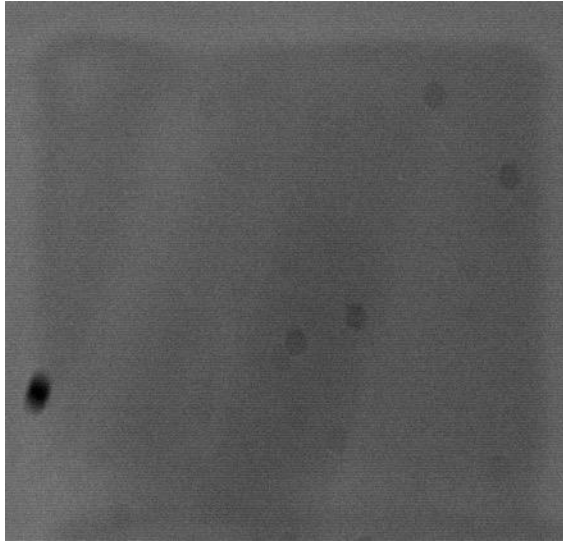

Figure 24. This flat field image reveals the nonuniformity of the pixel values due to QE variations, as well as defects (bright pixels) and dust (dark blobs) on the sensor. (Credit Wikipedia/ H. Raab, Johannes-Kepler-Observatory, Linz, Austria (<http://www.sternwarte.at>))

a gain table that will correct the Sky image for any variations in pixel QE or other artifacts of the picture-taking process and thereby 'flatten' the image.

Actual defects in the array, called hot pixels, can be simply masked out because they are fixed in space and time. For artistic purposes, these blanked out pixels can be filled-in with the average values of the surrounding pixels. For astronomical purposes, these are generally left alone as locations in the Sky image with missing data. The problem with what I have just outlined is that if you went ahead and applied it, you would still not get an accurate, flat-fielded image, although for the vast majority of astrophotographs this flat field correction solves most of the problems with the final image. For even better results, we also have to correct the raw sky images for sensor bias and dark current.

3.3 Bias Frames

When you weigh yourself on a bathroom scale, you may need to adjust the scale to read exactly zero when you are not standing on it because your mischievous dog or cat came in at night and tampered with the scale. Likewise, an electronic imaging array can have voltage offsets for each

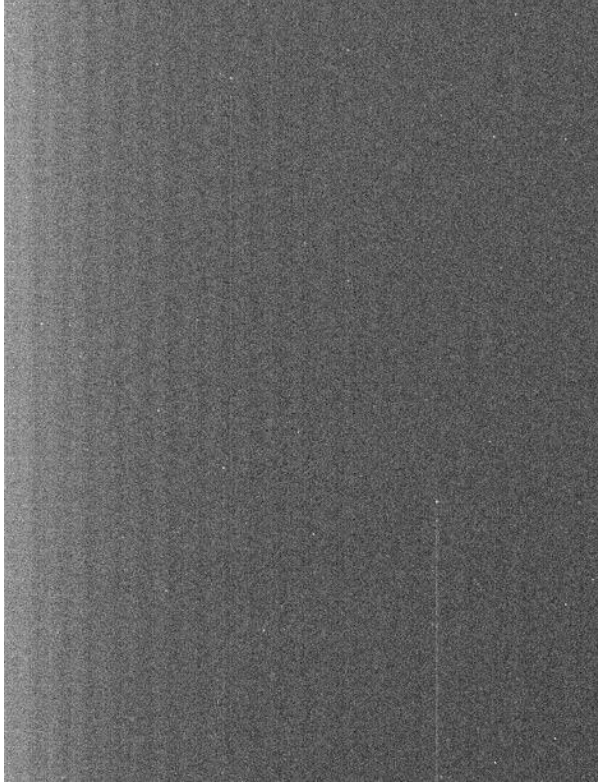

Figure 25. Example of a bias frame showing artifacts in the imaging array including vertical column boundaries and hot (bad) pixels appearing as white spots. (Credit Wikipedia/Fort Lewis College – Dept of Physics & Engineering)

pixel that alter the zero-level on how many electrons it thinks it has counted when no light is applied. We can create this Bias image by simply closing off the camera lens so that zero light falls on the sensor, and then setting the exposure time to its shortest possible value. The resulting image will show a variety of features called pattern noise that will be present in every image you take unless you correct for it.

3.4 Dark Current

Recall that pixels are like buckets collecting the electrons generated by the incoming photons. But there are other ways in which electrons can get into these buckets that has nothing to do with absorbing photons. The photodiode has a barrier region that is very thin separating the P and N materials. Because this material is warm, some of the electrons on either side of the junction can gain just enough energy by thermal jostling to surmount the energy barrier in the junction. This is equivalent to the walls of a real bucket emitting electrons into the bucket, thereby giving an incorrect count of the number of photons that

presumably created them. The thermal current can be greatly reduced by cooling the array to near-Absolute Zero temperatures. Correcting our Sky images for this dark current counting error is actually very simple. The resulting images called the dark current image, ‘dark frames’ or simply ‘darks’. Darks are created by simply closing off the array to external light sources and taking a photograph with exactly the same exposure time and ISO as the original Sky image so that the pixels can collect these noise electrons for the same period of time. The darks should also be taken at the same ambient temperature as the Sky images because dark current is temperature-sensitive. Astronomers do this by placing a cap over the camera lens. For smartphones and DSLRs, in-camera color correction must also be turned off to get the dark-frame image. Darks are different than Bias frames because for Darks you are running the camera at a setting that matches your Sky image in exposure time and temperature to study the pixel properties, while for Bias frames you are running the camera at its shortest exposure setting to study the properties of the pixel’s electronics.

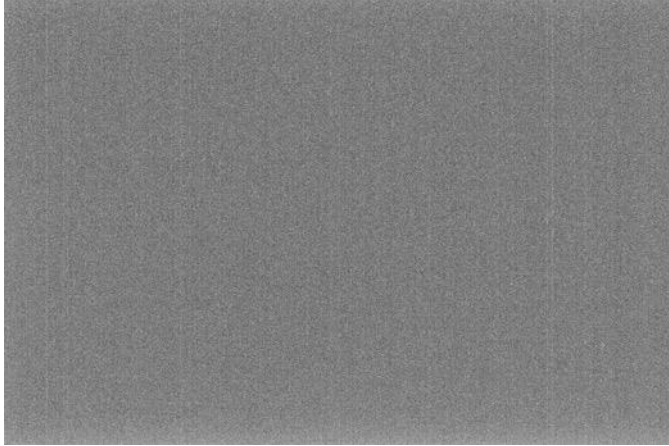

Figure 26. Dark frame from a Nikon D300 with enhanced contrast to emphasize noise. Notice the vertical pattern noise from the array geometry. This is removed in the calibration process by subtracting the ‘bias’ image described previously (Credit Wikipedia)

What we now have to do is go back and redefine how we use our flat-field images in the gain calibration. The dark image D_{xy} and bias images B_{xy} have to be subtracted from each flat image, F_{xy} , and from each raw Sky image S_{xy} to get the corrected or calibrated sky image C_{xy} , so we now get

$$C_{xy} = \frac{(S_{xy} - D_{xy} - B_{xy})}{(F_{xy} - D_{xy} - B_{xy})} \langle F - D - B \rangle$$

The quantity $\langle F-D-B \rangle$ is just the average value of $(F_{xy}-D_{xy}-B_{xy})$ over all of the pixels in the array. Usually, astronomers take many Darks and Flats near the time of the Sky image exposure, and then average

these multiple images to get the averaged ‘master’ Dark and Flat images. Bias frames need only be taken once unless you think your camera temperature is changing quite a bit during your photo session. Then these average Darks and Flats are used in the Sky image calibration. Here is a step-by-step guide to how to implement this process. It can be tedious to patiently collect over 50 photographs of the same star field for purposes of calibration. Fortunately, there are automatic ‘intervalometers’ that can take a series of photos while you go off and get a cup of coffee in your warm house.

Step 1 – Skys: Take your photos of the sky or of your selected astronomical object and find the ISO and exposure speeds that give you the best composition for your image. Take many (say 20) of these ‘Sky’ images and store them. The more you take, the fainter will be the stars and features you will see in the final stacked and coadded image.

Step 2 – Flats: Using the same camera settings for ISO and exposure speed, take multiple photos (say 20) of some uniformly-illuminated source such as the zenith twilight sky or an illuminated piece of white poster board or paper. Make sure there are no shadows or brightness gradients across the 2-dimensions of the target.

Step 3 – Darks: Cover the lens of the camera and with the same exposure time as for the Sky image, take multiple images (say 20).

Step 4: Bias: Cover the lens and set your exposure speed to its fastest mode. Take multiple exposures (say 20).

Step 4 – Download the raw Sky images and the multiple flat, bias and dark images to your laptop or desktop.

Step 5 – Use a software package such as *DeepSkyStacker* to add together and average the multiple Flats, Darks and Bias into a single F, D and B image.

Step 6 – Subtract the Dark image and Bias image from the Flat image to get the dark-corrected Flat image F_d .

Step 7 – Average all the pixel values of the corrected F_d image to get $\langle F \rangle$.

Step 8 – Calculate the gain table, G_{xy} , by dividing each Flat image pixel value in F_d by $\langle F \rangle$.

Step 9 – For each Sky image pixel, S_{xy} , subtract the averaged D_{xy} and B_{xy} from each pixel to get the dark-and-bias-corrected Sky image S_d .

Step 10 – Correct the Sky image S_{xy} by the pixel gains G_{xy} by dividing each S_{xy} by G_{xy} to get the final, calibrated and corrected sky image C_{xy} .

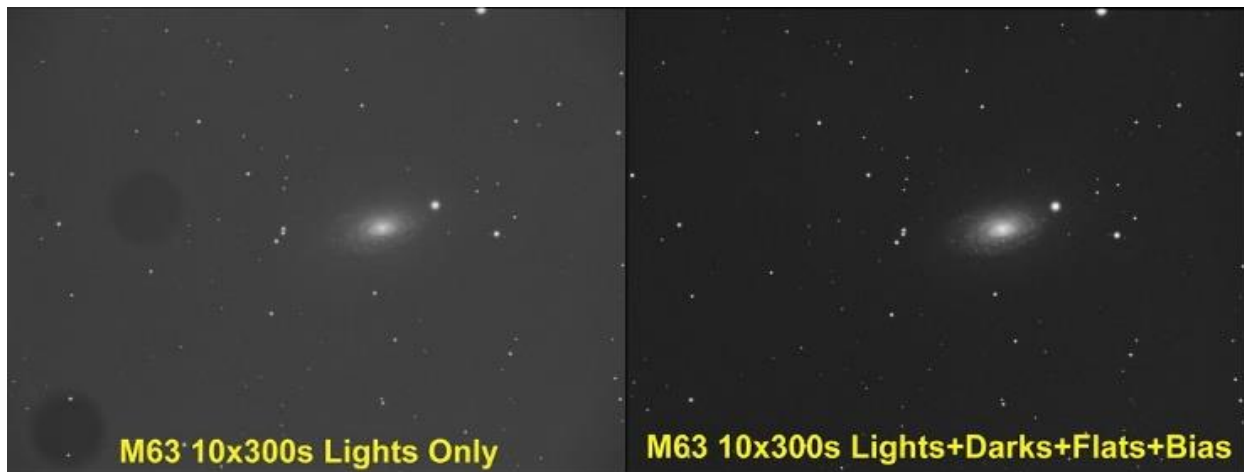

Figure 27. The galaxy Messier 63 with no corrections (left) and with the full Dark, Bias and Flat correction (right). Lights (Skys): 10x300s; Darks: 3x300s; Flats: 20x1.5s; Bias: 13x0.001s (Credit Jason Melquist)

For simple astrophotography applications, the original raw Sky image, adjusted with a program like *Photoshop* may be good enough for simple ‘beauty’ shots. But as amateur photographers get more sophisticated, they tend to strive for more perfect photographs that minimize camera artifacts and noise. Some objects look quite well with only the Flats subtracted from the raw Sky images, especially for brighter objects. For deep-sky objects (DSOs) such as galaxies and nebulae, it is almost a requirement that you perform the dark and bias steps to remove faint features that have to do with the camera electronics and not the object itself, and that can visually confuse the picture. This is why astrophotography is an ‘art’ and its product is subject to the tastes and patience of the photographer.



Figure 28. A simple one-shot photo of Orion with a **Samsung Galaxy S9+** phone at ISO 800 and 10 seconds on a camera tripod, with no corrections of any kind – not even Photoshop! This was shot in a Washington DC suburb with considerable light pollution such that only the five brightest stars in Orion were visible to the eye. The magnitude limit for the stars captured in this photograph was about +6.0m, which is about the limit to human vision under ideal conditions and no light pollution.

Once you have calibrated all of the Sky images you can now stack them to produce the final photograph. At this step, you can eliminate individual images that are not ‘perfect’ to achieve an even better result. Because atmospheric seeing changes rapidly, amateurs often take dozens or even hundreds of images in rapid fire, perform the calibration, and then eliminate the ones that are the most poorly focused. Some astrophotographers even take a video of the object, extract the individual frames, remove bad ones, then stack and coadd them to get phenomenal pictures of planets.

The resulting image can achieve near-telescopic resolution in this way and take fuller advantage of the telescope’s ability to see fine details. Also, things like jets, meteors, satellites and other transient light events can be eliminated. Below are some examples of what astrophotographers have produced using their smartphones. Many

astrophotographers find themselves so spell-bound by the beauty of the full night sky that they specialize in taking wide-field photographs like these. There is something deeply satisfying about taking the perfect photograph showing thousands of pin-point stars, perfectly focused, amidst the

patina of the nebulae and star clouds of the Milky Way. The trick to getting such images is to take many of them and combine them to get exposures of 30 minutes or more.



Figure 29. Orion taken with a Pixel 3XL using NightSight in Astrophotography mode, which corrects the images for dark and flats and then co-adds a series of images taken automatically by the camera. The Great Nebula (Messier 42) is just visible at the center of the photo. The magnitude limit for the faintest stars captured is about +8.0m; 5-times the brightness of the faintest stars the human eye can see under ideal conditions. This was shot in western Virginia in the Appalachians, which is one of the region's darkest observing sites. (Credit John Taylor)

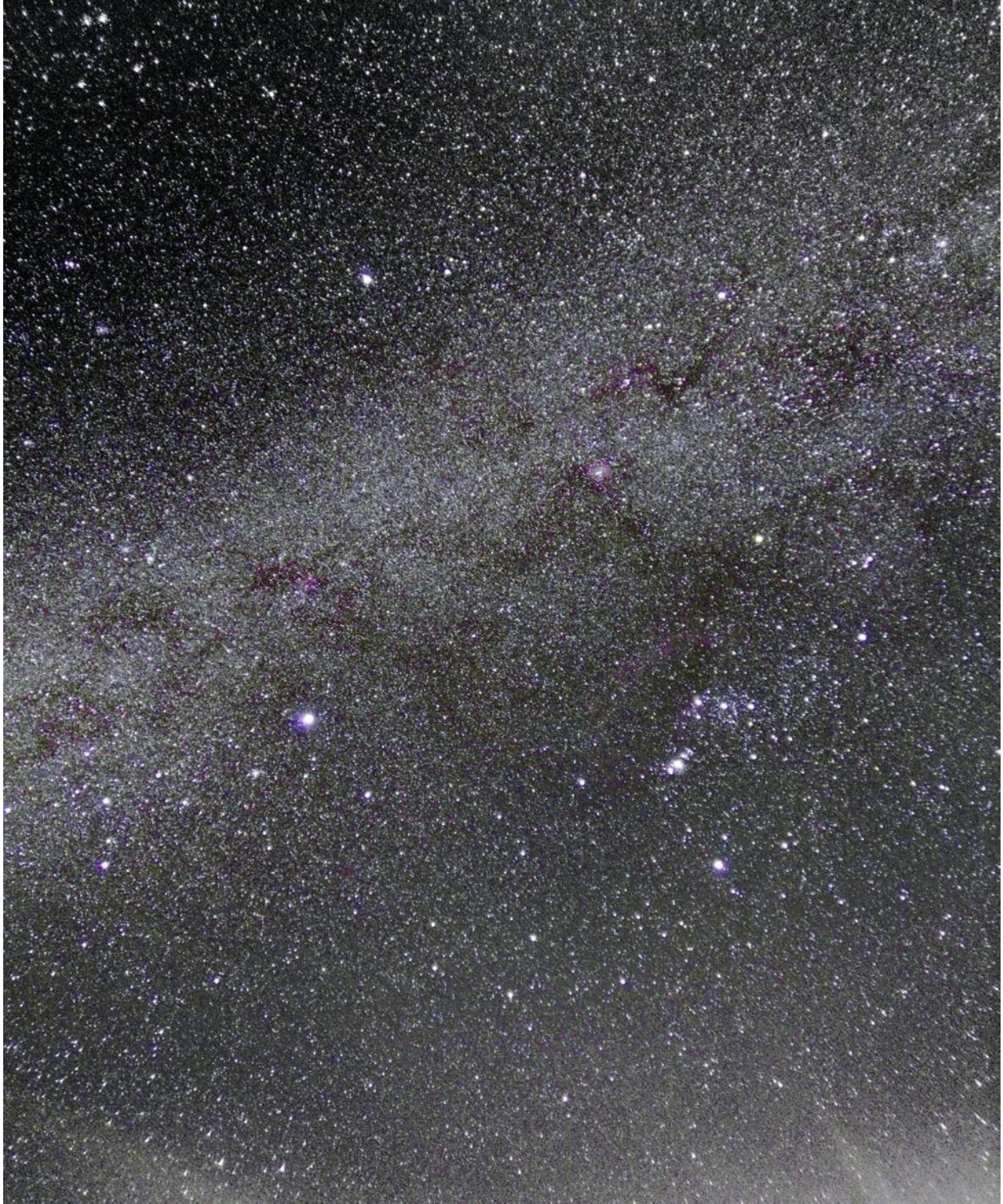

Figure 30. The Milky Way photographed with a HTC U Ultra phone at ISO 3200 with 67 images, each 16 seconds long including dark and flat correction. Dark clouds in the Milky Way are clearly visible. The estimated magnitude limit of the faintest stars is below +15m, which is some 4000-times fainter than what the human eye can detect! (Credit Shun-Chia Yang).

4.0 Which smartphone camera should I use?

Before the advent of smartphone camera systems, astrophotographers during 1960-1990 had to avail themselves of film cameras that they would attach to their tripods to take constellation photos, or attach to their telescope eyepieces to capture images of the moon and other objects. The photography involved using commercially available black-and-white ‘monochromatic’ films such as Tri-X that has ASA (ISO) values of 400. Some specialty ‘spectroscopic’ films were also available such as 103-aE or 103-aO used by professional astronomers that were more light sensitive in the red or blue visible light regions. These films had to be developed and printed by the astronomers themselves because if you sent your film to the neighborhood drug store for one-week processing, their systems would screw-up the process and often you would get a blank negative back. During the 1970s, amateurs also experimented with cooled-emulsion cameras. These systems cooled the film to dry ice temperatures, which significantly increased their ISO values from a few hundred to over 2000.

My own experiences started at age 13 with an old Exa, 35-mm SLR film camera that I would attach to a tripod and take time-exposure photos of the sky. The film would be developed in my walk-in closet that was temporarily sealed so no light would enter. I would learn how to extract the film from the film canister in the pitch-dark, and wind it on a spool for the developing can. A developer solution was added for five minutes, then removed and replaced by a ‘fixer’ followed by a thorough wash in water to remove all chemicals. When I turned on the light, I would have my first glimpse of whether I had captured any stars at all! The best shots were then placed in an ‘enlarger’ and I would develop my own photographs on paper because I knew that the local drug store would ruin the photos with their pre-set printing process. My first attempts under the light polluted skies of Oakland, California were impressive to me because they revealed stars I could not see with my naked eye. During the time I was a Boy Scout, I took numerous camping trips into the unpolluted skies of the Sierra Nevada mountains. Armed with my camera and tripod, I took hundreds of ‘star field’ photos. In one spectacular failure, I spent a week at a camp in Northern California called Camp Willets, and exposed an entire roll of film, capturing what I thought were beautiful constellation photos and dazzling views of the Milky Way star clouds. Returning to my home in Oakland, I immediately went into the closet ‘dark room’ and opening the camera, I discovered that the film had never advanced past the first frame of the negative spool. I vividly recall to this day 50 years later just how disappointed I was and the very noisy tantrum I threw.

For cameras, amateurs tended to use single-lens reflex (SLRs) from Pentax or Nikon because they were available at your local department or camera store, and had detachable lenses. This meant that you could take off the camera lens and place the camera body up against the telescope eyepiece, or simply remove the eyepiece and use the telescope as the camera lens directly. In this ‘projection’ mode, an 8-inch f/8 telescope becomes an f/8 telephoto lens with a focal length of 1600mm, compared to an ordinary f/2 camera lens with a focal length of 50mm.



Figure 31. Photo taken in 1971 from the summit of Mount Diablo, California with an Exa SLR film camera, with the camera's 50mm lens, Tri-X film, and a 45-second exposure to minimize star trailing. The Sagittarius 'teapot' is prominent in upper left corner. Limiting magnitude is about +7.0m and resembles what you could see with the naked eye. You can even start to see the diffuse light from the Milky Way. The glow from the street lights in the city of Livermore are at the bottom.

camera systems.

In Table 1, I list the phones marketed since 2013 that have been used by astrophotographers. The list is constantly growing as newer models are introduced almost every year. Phones that are highlighted are ones for which astrophotographers have provided astrophotos. Unshaded phones are also available for this purpose but have not apparently been used for astrophotography as of March 2020. This data has been obtained from the Facebook group 'Smartphone Astrophotography' that has over 4,000 members who are actively involved in this craft. The camera specs were found in the catalog provided by gsmarena.com (2020).

During the 1990s and 2000s, a whole new generation of imaging technology was deployed with the advent of digital cameras.

You could now purchase small 2-megapixel and large 30-megapixel digital cameras for a few hundred dollars. Instead of struggling with your own chemical development process in a 'dark room' you would export your images to a desktop or laptop and use a variety of powerful software programs to digitally combine and adjust your pictures. Still, these cameras were stand-alone systems that you had to buy separately.

This all changed in ca 1999 with the development of the first front-facing camera phone - the Kyocera Visual Phone VP-210. It was called a "mobile videophone" at the time, and had a 110,000-pixel front-facing camera. In 2003, more camera phones were sold worldwide than stand-alone digital cameras largely due to growth in Japan and Korea. In 2005, Nokia became the world's most sold digital camera brand. In 2006, half of the world's mobile phones had a built-in camera. Amateur astronomers were not slow to adopt this new imaging technology as an inexpensive alternative to more expensive, dedicated

The table provides information, where known, about the year of introduction (col.2), the camera’s effective f/number (col 3), the size of the imager in megapixels (col. 4), the size of the pixels on the imaging ‘chip’ in microns where 1 micron (μm) equals one millionth of a meter (col 5), The maximum exposure time available on the Native camera app that comes with the camera (col. 6) as well as its maximum ISO value (col. 7), and whether the camera exports RAW images (col. 8). The table also indicates (col. 9) whether the camera has a native camera with a manual or ‘Pro’ mode, and also if it has a special purpose low-light mode. A simple yes or no indicates whether a manual mode exists. The name of the low-light function is also included if present. Cameras noted in blue have actually been used for astrophotography in the figures to follow.

Table 1 – A sampling of low-light smartphone cameras for astrophotography.

1	2	3	4	5	6	7	8	9
Phone Model	Year	f/	Size (mpx)	Pixel (μm)	Native Camera Ability			
					Max exp	Max ISO	RAW files	Manual ‘Pro’ Mode?
Xiaomi Mi 9	2020	1.8	48	0.9			yes	<i>Night Mode</i>
Pixel 3a	2020	1.8	12	1.4			yes	No: NightSight
Moto G7 Power	2020	1.8	12	1.2			yes	No
Sony Xperia 5	2020	1.6	12	1.4	30		yes	Yes
OnePlus 7T Pro	2020	1.6	48	1.6	30	3200	yes	Yes: <i>Nightscape</i>
Oppo Reno 10X Zoom	2020	1.7	48	0.8			No	<i>Night Mode</i>
Pixel 4 / XL	2020	1.7	12	2.0	4	7111	yes	No
Galaxy Note 10 / S10+	2020	1.5	12	1.4	30	3200	yes	yes
iPhone 11 Pro Max	2020	1.8	12	1.4	30		yes	Yes: <i>Night mode</i>
Huawei Mate 30 Pro	2020	1.6	40	N/A	30	409600	yes	<i>Night Mode</i>
Xiaomi Mi CC9	2019	1.8	27	1.6			yes	<i>Night Mode</i>
LG-G8s	2019	1.8	12	1.4	30	3200		Yes: <i>Night View</i>
Xiaomi Redmi Note 8	2019	2.2	8	0.8	32	3200	No	<i>Night Mode</i>
Xaiomi Redmi 8	2019	1.8	12	1.4				
Galaxy 10+e	2019	2.2	16		30	3200		Yes
Xiaomi Redmi Note 7	2019	1.8	48	0.8	30	3200	No	<i>Night Mode</i>
Samsung A70	2019	1.7	32	0.8		800		No
Huawei Nova 5T	2019	1.8	48	0.8		102400	yes	<i>Night Mode</i>
Huawei Y5	2019	1.8	13					Yes
Xiaomi Redmi 7A	2019	2.2	13	1.1				Yes: <i>Night Mode</i>
Realme 3 Pro	2019	1.7	16	1.2				<i>Nightscape</i>
OnePlus 6T	2018	1.7	16	1.2			yes	<i>Nightscape</i>
LG V40	2018	1.5	12	1.4			yes	No
Pixel 3XL	2018	1.8	12	1.4			yes	<i>Night Sight</i>
iPhone XR	2018	1.8	12	1.4	30	2500	yes	No
iPhone XS max	2018	1.8	12	1.4		6400	yes	No
Huawei Mate 20P	2018	1.8	24	1.5			yes	<i>Night Mode</i>
LG Q7+	2018	2.2	13	1.1			yes	Yes
Oppo f9 pro	2018	1.8	16	1.0				<i>Night Mode</i>
LG G7 ThinQ	2018	1.6	16	1.0				Yes
Huawei Nova 3i	2018	2.2	16					yes
Xiaomi Pocophone F1	2018	1.9	12	1.4	32	1600		yes
Galaxy Note 9 / S9+	2018	1.5	12	1.4	10	800	yes	yes

Motorola Moto Z2 Play	2017	1.7	12	1.4			yes	yes
Xiaomi Mi 6	2017	1.8	12	1.2			yes	
Sony Xperia XZ1	2017	2.0	19	1.2			yes	yes
Nokia 8	2017	2.0	13	1.1	0.5	1600	yes	yes
HTC U11	2017	1.7	12	1.4	32	800	yes	yes
Huawei Mate 10	2017	1.6	12	1.2	30	3200	yes	yes
iPhone X	2017	1.8	12	1.2			yes	
iPhone 8 / 8plus	2017	1.8	12	1.2				No
LG V30 / G6	2017	1.6	16	1.0	30	3200	yes	yes
Samsung A5	2017	2.0	13	1.6				No
Galaxy S8 / Note8	2017	1.7	12	1.4	10	800	yes	yes
Pixel 2	2017	1.8	12	1.4			yes	no
HTC 10	2016	1.8	12	1.5	2	1600	yes	yes
Xiaomi Mi 5	2016	2.0	16	1.1			yes	
Huawei 9	2016	2.2	12	N/A			yes	
Nubia Z11	2016	2.0	16	1.1	72	12800	yes	yes
OnePlus 3T	2016	2.0	16	1.1	30	3200	yes	yes
Motorola Moto Z	2016	1.8	13	1.1			yes	yes
Galaxy S7 edge	2016	1.7	12	1.4		1600	yes	yes
Google Pixel XL	2016	2.0	12	1.5	60	14013	yes	yes
iPhone 7/7plus	2016	1.8	12	1.2			yes	No?
LG V20	2016	1.8	16		30	3200	yes	yes
iPhone SE	2016	2.2	12	1.2			yes	
Sony LG G5	2016	1.8	16	1.1	30	3200	yes	yes
Xiaomi Redmi 3s prime	2016	2.0	13				yes	no
Google Nexus 6	2015	2.0	13	1.4			yes	no
Sony Xperia Z3	2015	2.0	20	1.1		800	no	yes
HTC One M9	2015	2.2	20	1.1	2	1600	yes	yes
LG G4	2015	1.8	16	1.1	30	2700	yes	yes
Galaxy s6 Edge	2015	1.9	16	1.4	10		no	yes
iPhone 6 / 6s	2015	2.2	8	1.2			no	no
Samsung Note 5	2015	1.9	16	1.1	10		yes	yes
iPhone 5s	2013	2.2	8	1.5				

In a random sampling of astrophotographers, the most often cited phones were the Pixel 4XL, the Samsung Galaxy S10, the iPhone 11 Pro Max, the Huawei Mate 30 Pro and the Galaxy S9+. The crucial factor is how these cameras perform under low light level conditions. Although this can be an issue if you want to do ‘one shot’ photography, if you work with various stacking and image-correction methods described previously, the various commercial evaluations of some cameras being ‘poor’ for low light level photography can be overcome. For example, the OnePlus 7T Pro, Xiaomi Redmi Note 8, Nokia 8, and LG V30/G6 were evaluated by various consumer websites as being poor, but have been used successfully by astrophotographers to produce stunning images of the constellation Orion, as well as deep sky objects such as the Orion Nebula (Messier-42), the Whirlpool Galaxy (Messier 51) and the Eskimo Nebula (NGC 2392) through telescopes. What is amazing is that even some of the older phones such as the iPhone 5s and 6s may be poor for wide-angle, starfield photography, but when placed at the eyepiece of large telescopes, produce exceptional images. The most commonly photographed subjects at the time this book was written (ca winter 2020) was not surprisingly the very bright constellation Orion, the Moon, the Great

Nebula in Orion (M42), the Pleiades star cluster (M45), and the planets Jupiter and Saturn through large telescopes up to 20-inches in aperture.

5.0 Software

5.1 The Native Camera

Smartphones come with built-in camera apps called the ‘Native App’. In some cases, these can be very powerful programs that allow you enormous access to the basic functions of the camera such as adjusting exposure speed, ISO and other factors. Camera apps come in two types; The first is fully automatic and does not allow you to change any of the settings manually, while the second kind provides some ability to adjust ISO and exposure. In all cases, the f/number is fixed because there is no room in a camera to add a mechanism to physically change the lens’s preset F/value which is typically in the range from 1.5 to 2.2. For astrophotography it is essential that you have the ability to manually control the exposure speed and ISO to get the sensitivity you need to detect stars in the sky, or to capture images through the eyepiece.

5.1.1 Manual Mode

A *Samsung s9+* phone has a set of icons at the bottom of the screen when you power it up. The one on the far right is the Native camera. When you tap it and get the camera screen in Figure 32.

If you tap on the icon for the second item from the left on the top line it will open the exposure speed slider shown in Figure 33, which shows you can adjust the speed from 1/24000 of a second to 10 seconds. For fast-moving objects in bright scenery such as speeding cars or athletes, short exposures produce unblurred images. For very dim lighting you will need much longer exposures to gather enough light.

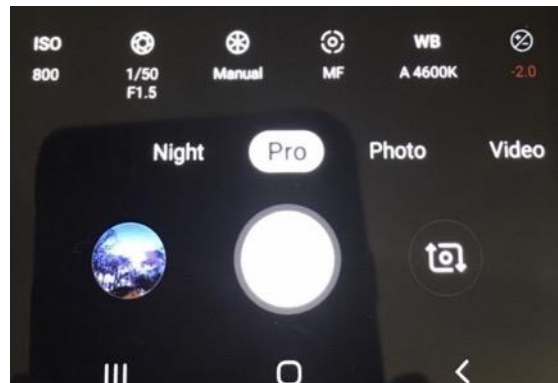

Figure 32. A camera app screen showing the ‘Pro’ mode selector.

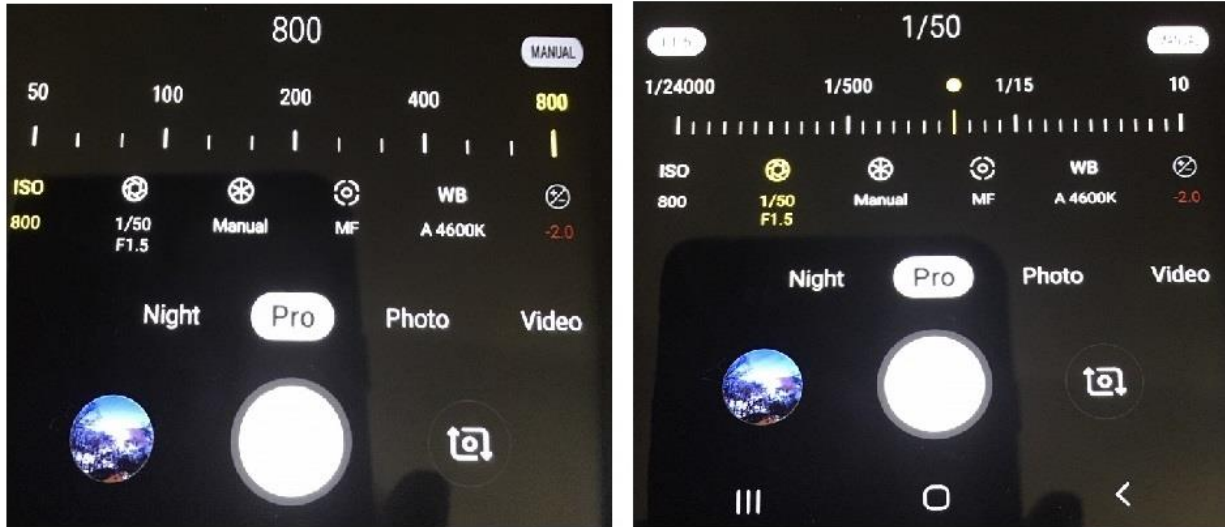

Figure 33. Selecting the ISO (left) of 800, and exposure speed (right) of 1/50-seconds.

The next feature is ISO, and if you return to the main camera screen for the ‘Pro’ mode, tap on the ISO icon to get the screen on the left in Figure 33, which has a slider you can adjust from an ISO of 50 to 800. Native cameras from one model to another may look slightly different. Some may let you adjust exposure speed but not ISO or vice versa in their ‘Pro’ or ‘Manual’ mode. If your camera does not have this ability, you are going to need to go to your app store and get one of the camera apps like the ones I will discuss in the next chapter.

Another important feature of many cameras is a timed delay, which can be set for 3 to 5 seconds before the camera actually takes the image. This will minimize any shaking or jitter when you use the smartphone on a tripod or telescope to take an image.

5.1.2 Low-Light Photography

Since about 2018, newer phones have been developed that allow you to photograph people and scenery during twilight or other low-light conditions, but still get high-quality pictures. There isn’t much you can do with the lens sizes to make this happen, but developers have created some impressive cameras that use a clever software fix for this problem. In fact, it is the same fix that astronomers have been using with their observatory-grade digital cameras for decades and involves stacking, flat fielding and coadding. This new feature is called by various names such as *Night Mode*, *Nightscape* or *Night Sight*.

Night Sight (Pixel 3) takes up to 15 images and combines them using an Artificial Intelligence (AI) process in their HDR+ and Super Resolution Zoom software to align the images based on features in the scenery. It is automatically engaged when cameras sense low light conditions, and in Pixel 3 an option button will appear in the camera display that you can tap if you want to use this feature. Otherwise it is found by tapping the ‘Portrait’ icon in the camera display. *Night Sight* automatically adjusts the ISO and exposure speed for each image to reduce or remove motion blurring (e.g. Googleblog). More images will be taken, up to 15, if there is any detected camera

movement and the images will be biased towards higher ISO and shorter exposure times. If there is no detected motion, the exposure times will be automatically lengthened and the ISO reduced to reduce graininess and image noise.



Figure 34. Left: Crop from a handheld Night Sight shot of the sky. There was slight handshake, so Night Sight chose 0.33 sec x 15 frames = 5.0 seconds of capture. Right: Tripod shot. No handshake was detected, so Night Sight used 1.0 second x 6 frames = 6.0 seconds. The sky is cleaner (less noise), and you can see more stars. (Credit Florian Kainz)

Night Mode (iPhone 11) - This is an automatic setting that uses the wide-angle camera, which lets in more light for low illumination conditions. The cameras in the iPhone family automatically choose the number of frames needed to create a suitable image. The camera then takes a series of images for a set amount of time. This lets the iPhone extract the best parts of the scene, highlighting what's important. After the set amount of time, which can be up to five seconds or more, each photo that was taken is aligned to account for movement. It tosses out the images that are too blurry, and then fuses all the sharpest images of the bunch. You can tap on the moon icon at the top of the Camera interface to get to the *Night Mode* settings. This allows you to change the interval from the recommended level to a longer time period. When taking photos of the night sky, the *Night Mode* function gives you the option of using very long exposure times allowing more stars to be detected, but you need a tripod for this application.

Nightscape (OnePlus 6; Realme 3 Pro) – This is a new camera function introduced in the OnePlus 6 phone in 2019. The camera automatically takes a series of photos, one at a high ISO at long exposure, plus several short exposure images. The short exposure images are used by the camera's 'AI' program to identify where each object in the picture is with no effective motion. It then uses this information to 'stabilize' the long-exposure image. It also applies a noise reduction algorithm and image sharpening to make straight lines look crisper, which also causes feature and

objects in the image to have a sharper ‘daylight’ appearance. The noise reduction feature can make stars in the sky more numerous.



Figure 35. Orion and the Pleiades photographed with a Samsung **Galaxy Note +10** with Night Mode. (Credit Geoffrey Baker)

Figure 36. A portion of the Milky Way photographed with a Google **Pixel 4** with Night Sight Mode (Credit Drew Langford)

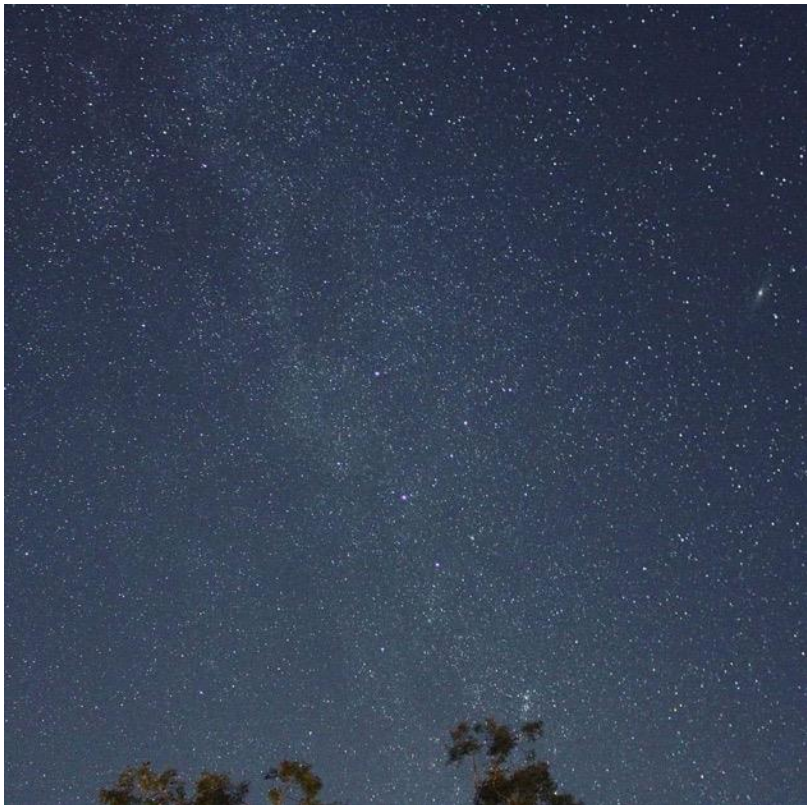

Astrophotography Mode (Pixel 4) Google developed *Astrophotography* mode for its Pixel 4 camera. It allows exposures up to 4 minutes on Pixel 4, and 1 minute on Pixel 3 and 3a. It is automatically enabled in the *Night Sight* mode when the camera senses the light conditions are very low. You do not have manual control over it activating. The latest version makes it possible to take sharp and clear pictures of the stars in the night sky. The Pixel 4 combines 16, 15-second exposures into a single four-minute-equivalent exposure, while the Pixel 3a and Pixel 3 combine four of these frames into a one-minute exposure. During this time the camera takes images and performs a stacking of these images, deleting the ones with the worst noise characteristics or apparent movement. The Milky Way captured using the Google *Camera App* running on a Pixel 4 XL phone shows significantly more detail than the unaided eye on a night this dark. The dust clouds along the Milky Way are clearly visible, the sky is covered with thousands of stars, and unlike human night vision, the picture is colorful.

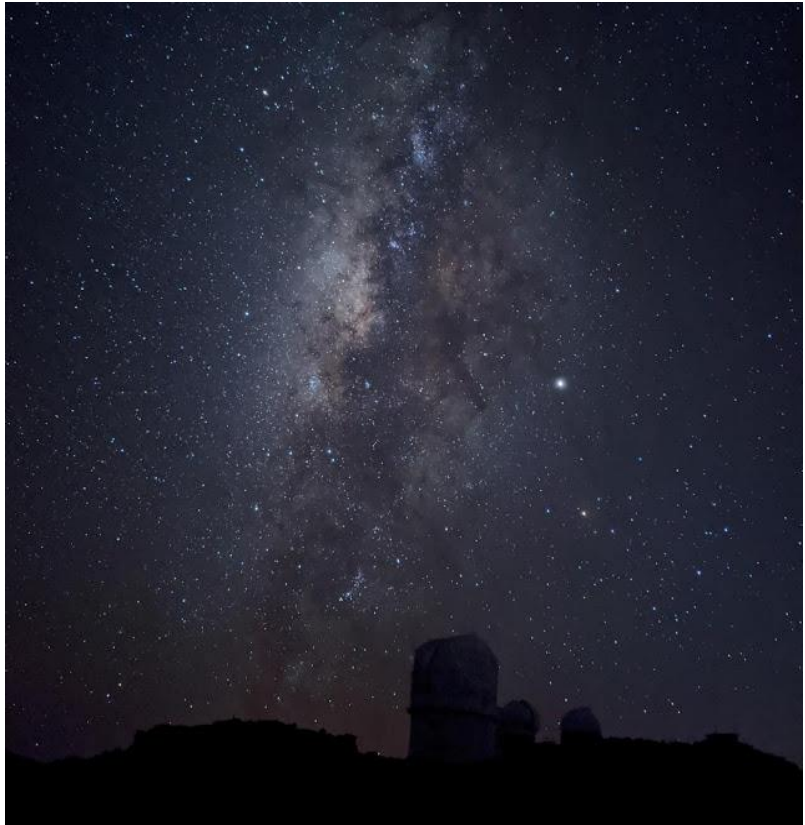

Figure 37. Google's Astrophotography mode on its Pixel 4 easily reveals the Milky Way (Credit Florian Kainz)

5.2 Third Party Apps

Native camera apps that come with your camera often do not allow significant changes to the automatic settings of the camera although some phones at least allow changes to ISO from 100 to as much as 3,200, or exposure speeds up to 30 seconds per image. In some cases, such as the early iPhone models, only the camera has access to changing these settings. For some modern cameras after about 2015, the built-in 'manual' mode does in fact let you adjust ISO and exposure over these full ranges. Nevertheless, astrophotography, and in particular star field photography of large portions of the night sky to capture the Milky Way or constellations, require much longer exposure times.

One strategy is to expose the sky for many minutes at a time, however because of diurnal motion, the stars in the final image will be streaks and not well-focused pinpoints. This happens for exposure longer than about 30 seconds. Also, the sky itself can suffer from light pollution and so longer exposures tend to amplify sky glow and so you lose the blackness of the sky in a single shot. Another strategy is to take lots of short-exposure images that eliminate star motion and reduce

skyglow, however in order to combine these separate images into one deeper image, you have to use ‘stacking’ software and learn the art of image manipulation. If you want to be able to set exposure and ISO values by hand and not rely on the native camera, you have to use a camera app that accesses the image output from the array in each of the three colors, and allows the exposure speed and ISO speed to be adjusted. The f/stop is fixed by the aperture unlike for normal digital/film cameras.

Camera+ (iOS, \$2.99) by LateNiteSoft Apps includes automatic metering as well as a self-timer to delay the triggering of the exposure by up to 15 seconds. The manual mode lets you adjust the exposure speed (1/8000 to 30sec) and ISO (0.01 to 2000) independently using sliders on the screen. Images can be saved and emailed to be downloaded on a laptop or PC for further processing with Photoshop etc. The image files are available in jpeg, TIFF or DNG/RAW formats. The native app on this phone does not let you adjust exposure and ISO.

Camera+2 – (iOS, \$3.99) also by LateNiteSoft S.L. is an updated version of Camera+ and was developed for the iPhone. Like most camera apps it lets you manually change shutter speeds up to 30 seconds, and alter the ISO and white balance. This app compensates for the older iPhone model native cameras that provide no manual mode. If your phone has multiple lenses it will select the one with the best quality for the given situation. Photos are automatically stored in the Lightbox archive and from there can be edited or emailed. It also exports RAW files for further advanced editing and analysis.

Procamera (iOS, \$7.99) by Cocologics, gives you control comparable to an advanced DSLR camera with semi-automatic and full manual controls. You can set specific values for exposure time, ISO sensitivity. There is a self-timer and live image histogram feature as well as the ability to remove Geo-Tags and/or resize photos and videos when sharing via text message, email, or to social media.

Camera FV-5 (Android, Free/\$3.95) by FGAE emulates various DSLR camera features including manual shutter speeds up to 30 seconds, ISO from 50 to 3200, light metering, and focus. It also supports JPEG, DNG/RAW, and PNG file formats which can be viewed in the phone’s Gallery and then processed or emailed. Long exposures from 0.3 to 60” with an accuracy of 0.1 seconds are available. This app also comes with a user manual (CameraFV5).

Open Camera (Android, Free) by Mark Harman. Provides full manual controls (with optional focus assist); burst mode; RAW (DNG) files; slow motion video. Noise reduction (including low light night mode) and dynamic range optimization modes for better quality photos.

DeepSky Camera (iOS, Free) by Michael Seeboerger-Weichselbaum – requires that the phone camera have a RAW image format mode. The camera operates as a standard astrophotography camera that requires not only the main image of interest but several other images to correct for camera and sensor issues. The maximum ISO depends on the camera sensor. Most sensors limiting the ISO value to 800. You can select a higher value but the sensor will set it to maximum ISO level

of the sensor. LG G supports ISO up to 6400, Google Pixel up to 12800. Most of the sensors limit the maximum exposure time to 30 seconds. There is also a manual (*DeepSkyCamera*) for how to use this app, which is rare among apps you can find.

NightCap (iOS, \$2.99) by Realtime Dreams Limited, offers artificial intelligence (AI) camera control by automatically setting optimum focus and exposure. Special camera modes also give you DSLR-like results. The Long Exposure mode significantly reduces image noise under low light conditions. There is also an ISO Boost feature that allows 4x higher ISO than any other app. There are four dedicated astrophotography camera modes: Stars Mode is ideal for a starry sky or Northern / Southern Lights (Aurora), or in Star Trails Mode. There are also two modes for easy photography of the International Space Station and meteors. An extensive how-to guide to astrophotography with *NightCap* is provided by Taylor (2020).

HD Camera Pro (Android, \$2.99) by the HDM Dev Team, gives heavy customization to your phone's camera settings. Exposure, ISO, and filters can all be modified as well as its HD videos. There are many other features as well including interval timers, motion compensation and basic image editing.

5.3 Stacking and Adjusting apps

Registrax 6 – Developed by Cor Berrevoets for Laptops and desktops. This is a free image processing software from <https://www.astronomie.be/registax/> designed to run in a Windows environment. It ingests a series of still images of the same object, or a video series in AVI format, and aligns them so that the 'stack' of images can be added together. It works exceptionally well on star fields and on objects with sharp edges, which are detected and used as a reference to align subsequent images. The ability to shoot an AVI video and then have the individual frames in the video combined into a final still image is one of its most significant features.

Deep Sky Stacker – <http://deepskystacker.free.fr/english/index.html>. *DeepSkyStacker* for laptops and desktops, is a freeware for astrophotographers that simplifies all the pre-processing steps of deep sky pictures. Registering; Stacking; Simple post-stacking processes to quickly view the final result; Saving the resulting image to a TIFF or FITS file (16 or 32 bit). After a shooting night you give all your pictures (light frames, darks frames, offset/bias frames, flat frames) to *DeepSkyStacker* and you go to bed. The next morning you can see the result and start post-processing. *DeepSkyStacker* cannot be used for planetary pictures registering and stacking.

Snapseed (iOS) photo editor by Snapseed. Works with RAW image files that can be opened and tweaked, saved non-destructively or exported as JPG. Exposure and color can be adjusted automatically or manually. Surface structures in images can be enhanced, and images cropped to

standard sizes along with image rotation and basic geometric correction to remove horizon distortion.

5.4 Intervalometers

A typical astrophotography program can involve taking dozens or even hundreds of consecutive photos to create beautiful star trail photos or to hunt for faint deep sky objects. To remove the tedium of doing this by hand and shaking the camera each time, apps called intervalometers will automatically take sequences of photos at selectable time intervals and exposures.

Lapse-It (Interactive Universe \$1.99; Android and iOS) Frame interval can be adjusted from 1 to 99,999 intervals that can have units of either milliseconds, seconds or minutes (i.e. 1 to 99,999 milliseconds or 1 to 99,999 minutes). Each frame is taken from your native camera and the exposure and ISO per frame are set by tapping the red ‘Capture’ button on the app startup screen, and then tapping the ‘Shutter’ tab, which will open up two slider bars to set the frame exposure and the ISO. An initial delay before start can be added to remove set up shaking. You can select resolutions from 420p to 1080p or ‘full sensor’. Shutter sound can be enabled/disabled. The app will take the sequence of images and then render them into a video stream in MP4 or MOV formats. You can also schedule the start and stop dates and times. The individual image files can be named according to a convention you choose (Orionxxx, MilkyWayxxx where xxx will be the frame number) and will then be consecutively numbered. Programs like RegiStax6 or DeepSkyStacker can then be used to combine the images.

NightCap (iOS, \$2.99) by Realtime Dreams Limited. There are four dedicated astrophotography camera modes in this app including a *Star Trails* mode. Turn on *Star Trails* mode and tap the shutter button once to start capturing, then wait at least 15 minutes before tapping the shutter again to save the photo. The longer you wait, the longer the trails will be, and you can see them forming on screen. An extensive how-to guide to astrophotography with *NightCap* is provided by Taylor (2020).

6.0 External Equipment

The only way to optically improve the clarity of an image is with the smartphone attached to a telephoto lens, a pair of binoculars, or a telescope. This makes the aperture of the camera lens much larger than 4-mm, and so it dramatically increases the resolution of the final image. This equipment also decreases the angular scale of the smartphone field of view, which is covered by the array pixels.

6.1 Telephoto Lenses

Tripod adaptors for smartphones can be found on the Internet and cost between \$3 and \$10 brand new, but you can also find them more inexpensively at several auction sites on the Internet. A telephoto lens system is absolutely a must-have for lunar and eclipse photography with a smartphone. There are a number of zoom lenses for smartphone photographers designed solely to

provide magnification without resorting to digital zoom. Most of these such as the one in Figure 38 (right) clip directly to the smartphone over the existing lens, and provide total magnifications of 8x for less than \$20.00, and 12x at a cost usually under \$40.00, but you will need to purchase a tripod for your smartphone to avoid shaking. Some 12x systems like the one shown in Figure 38 (left) include a tripod and a mounting bracket for the smartphone that is far sturdier than a clip-on system.

It is worth pointing out that the magnification touted by smartphone telephoto lenses is not the optical magnification, which is customarily used by astronomers and opticians to describe an optical system. It is common in the smartphone telephoto industry to advertise the maximum product of the smartphone's digital magnification times the optical magnification of the telephoto. It is only, however, the optical magnification that affects the resolving 'power' of the system as we will discuss in a later section following actual measurements of various systems.



Figure 38. Examples of common telephoto lenses for smartphones.

At an advertised magnification of 12x, with a digital magnification of 3x and an optical magnification of 4x (e.g. $3 \times 4 = 12$), the moon disk will be optically magnified by a factor of 4 times and its diameter will cover 4 times as many pixels as a normal 1x camera view. The optically-enhanced resolution equivalent to a low-power (4x) binocular view (e.g. 4x50) results in rather clear viewing of the moon's dark mare features.

To rival a binocular view (7x50) you need a telephoto with an optical magnification of 7x or an advertised magnification of $3 \times 7 = 21x$ or higher. Nevertheless, the properly designed and mounted '12x' system provides images of the moon that are quite adequate for eclipse photography and promises to resolve some of the larger details of the sun's coronal structure during a total solar eclipse provided the exposure is in the proper range to avoid coronal over-exposure and burn-out.



Figure 39. This is a photo of the moon taken on a tripod with the *Camkix 12x* telephoto on an **iPhone 6s** and the *Camera+* app. A 5-second delay timer was used to eliminate jitter.

because the smartphone wobbles and vibrates with the slightest touch. The telephoto adaptor forces you to place the smartphone in its highest position in the adaptor, making it even more unstable. The telephoto has to be manually adjusted so that the lens is aligned with the camera lens and so that it is properly focused on a target like a distant streetlight or the moon, but rotating the telephoto focus can cause the lens to slip out of collimation so that this whole process has to be repeated multiple times, in the dark, and in the nighttime cold. The only practical way to use smartphone telephoto lenses for photographing objects other than the sun and moon, is for you to literally re-engineer the tripod and telephoto adaptor yourself.

I spent an evening on a cold night in March trying to photograph one of the largest, most compact, and brightest star clusters in the sky, namely the Pleiades. First, I set up the telephoto to photograph the full moon, which was always easy to acquire in order to collimate the telephoto, but finding the Pleiades opened up a new challenge. I could not actually see it in the sky due to

Lunar eclipses are common enough that these should also be considered targets for smartphones with telephotos. Related in size to our moon is our sun, and during total solar eclipses one would have the opportunity to photograph the solar corona.

One thing to recognize with any clip-on telephoto is that for astrophotography other than the moon and sun, they are very awkward and finicky to use with the commonly available technology. First of all, the smartphone adaptor to a tripod is mechanically unstable



Figure 40. The wide-angle shot of the Pleiades area with a Samsung **Galaxy S9+** using the Native camera set at 10-seconds and ISO 800. The Hyades star cluster and its characteristic V-shape are partly hidden by the tree branches at the upper left.

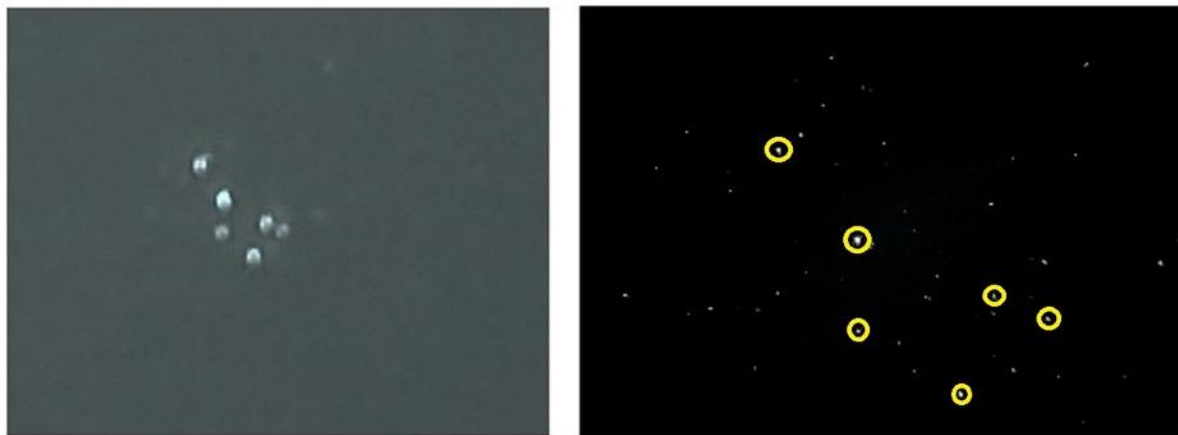

Figure 41. A comparison of the Pleiades photographed with (right) a Samsung **Galaxy S9+** through a 4.5-inch telescope and a low-power 24-mm eyepiece and (left) the enlarged image from the smartphone wide-angle image in Figure 40.

urban light pollution, but when I used the smartphone by itself and shot a 10-sec ISO-800 image it was easy to spot on the photo shown in Figure 40, to get the general sky direction. I then re-attached the telephoto and collimated on the moon again. Pointing the smartphone-plus-telephoto in the general direction of the Pleiades, I scanned the sky in a raster pattern until I found the Pleiades through the telephoto. It was out of focus so I had to turn the telephoto focus knob a bit at a time until I got sharper star images. Each time, though, the telephoto would slip slightly and I had to re-find the Pleiades. I also used a small 4.5-inch telescope to also photograph the Pleiades to compare how well the telephoto performed.

The comparison between the enlarged smartphone image and the telescope in Figure 41 shows that focusing a smartphone to get pinpoint star images on a wide field view is a challenge and is limited by a simple optical consideration: Even on a night of near-perfect seeing, star images will be no smaller than about one arcsecond in diameter. The ordinary resolution of a smartphone camera is about 50 arcseconds with four of its pixels covering this resolution spot size. This means that all of the star images will be focused onto a 2x2-pixel area on the imaging sensor. There is no way to make star images appear sharper in focus than the inherent limit set by this 2x2 pixel area, so star images will always look distorted into squarish pixelized patches in the sky image when a digital zoom is used. This is why enlarging a smartphone constellation image will make the stars look odd and boxy, and not circular. The telescope image, however, has the telescope greatly magnify the star images so you can see more of the object (e.g. star cluster) in focus across the camera imaging sensor, but the focus problem still remains for the individual stars. Because their magnified images now subtend more pixels, you get nicer looking star images that don't show as much of the pixelization problem.

Once again, cameras come with delay timers which can be set at 3-5 seconds after you start the exposure. This minimizes any jitter or shake and produces much cleaner photographs.



Figure 42. Pleiades seen with a smartphone 12x telephoto and a **Galaxy S9+** set at 10 sec and ISO 800 (left) and (right) a 4.5-inch telescope with similar settings. Limiting magnitude is about +8m.

One trick used by smartphone astrophotographers is to use a hand magnifier to study the star images displayed on the smartphone screen. By adjusting the lens focus you can get these images to be pinpoints and so they will look much better in the resulting photographs.

Under the best focusing conditions I could obtain juggling the smartphone telephoto while trying to maintain collimation, Figure 42 shows that at least the telephoto can in principle provide some interesting possibilities compared to a low-power telescope view. The telephoto optics with a 20 mm lens aperture provides enough light gathering ability that you can capture many of the same faint stars as for a 4.5-inch (115-mm) telescope. In fact, from a simple area consideration $(115/20)^2 = 33$, the telescope has 33-times the light gathering ability, which means that it can see stars about $(2.512)^4$ or 4 magnitudes fainter. Nevertheless, using the Pleiades cluster stars and their known magnitudes, this exposure setting of 10-sec and ISO 800 lets you photograph stars as faint as a visual magnitude of +6.7m. A shorter exposure and higher ISO would significantly minimize the trailing of the star images. The telescope view, however, lets you see stars as faint as +10m using the same camera and settings. Clearly a smartphone telephoto will help you see a bit more clearly some of the brightest star clusters and nebulae in the sky, but are no substitutes for even a small telescope or a pair of good binoculars with their larger optical apertures and light-gathering ability.

6.2 Binoculars

If you have a pair of binoculars you can try one of two strategies: you can have your friend hold the binoculars and then position your smartphone camera lens up against the eyepiece, or you can get a binocular-smartphone adapter and a tripod. By the way, if you go for the later approach



Figure 43. The Pleiades shot through a pair of 10x50 binoculars with a **Galaxy S7-Edge** phone. Five, one second ISO 800 exposures with *AutoStakkert 3* to stack the images. (Credit Jussi Laasonen).

you will have a fantastic system that you can use for many other photographic opportunities like capturing photos of birds and wildlife, as well as close-up views of sports events or other public activities.

It will be difficult to use the hand-held binocular and camera because there are so many factors that you literally have to juggle to make it work. There will be a lot of movement of the camera and binoculars that will make getting a properly-focused shot hard to take.

The only sensible solution is to get a binocular attachment for your tripod, and a smartphone lens adaptor for the binoculars. With this set up, all you have to do is point the tripod/binocular at your subject and set the focus on your binoculars and camera once and for all. Then you just need to touch the camera exposure button when you want to take a shot, or better yet, set the camera for video mode! Binocular tripod clamps are easy to find on the Internet and cost between \$10 to \$20 for the simple screw-type adaptor, or \$25 for the strap-type adaptor that works for nearly all types of binoculars. Remember, this is an investment that by itself will pay dividends later on when you want to observe non-astronomical subjects, so it is definitely not wasted money.

Camera lens adaptors for binoculars can also be found on the Internet and cost between \$10 for one

you will have a fantastic system that you can use for many other photographic opportunities like capturing photos of birds and wildlife, as well as close-up views of sports events or other public activities.

It will be difficult to use the hand-held binocular and camera because there are so many factors that you literally have to juggle to make it work. There will be a lot of movement of the camera and binoculars that will make getting a properly-focused shot hard to take.

The only sensible solution is to get a binocular attachment for your tripod, and a smartphone lens adaptor for the binoculars. With this set up, all you have to do is point the tripod/binocular at your subject and set the



Figure 44. The Andromeda Galaxy with 7x50 binoculars and an **Android HTC U 11** phone and RAW 300, 2-sec image stacking. (Credit Rory Griffin/AstroBiscuit)

designed specifically for your camera type, or between \$50 - \$70 for a universal adaptor that fits most phone types, and that you can use for telescopes too. All you need to do is use the automatic exposure and focus camera setting and hand-point the binoculars at whatever you want to study close-up. The angular field-of-view of a common 7x50 binocular is 6.8° at 7x power, so it is a good match to capture large and bright galaxies like Messier 31. A similar FOV is required for the Large (10°) and Small Magellanic Clouds (4°).

6.3 Telescopes

The possibilities are endless for combining smartphones and telescopes, limited only by how much you want to pay for these large apertures. In the end, it will be a compromise because the larger the telescope, the less likely you are to want to drag it out of your closet and set it up outside. I recently had the option of buying any telescope I wanted to up to a limit of \$5000. But the first constraint I had was that it had to fit inside my car, a 2016 Toyota Camry, if I wanted to drive to a dark site two hours away from my suburban home for some serious viewing! My dreams of buying a 20-inch monster evaporated in favor of a modest 12-inch telescope that could fit in my trunk and back seat, but, alas, with little room left over for luggage or my family!

Generally, you want a telescope that has a stable mounting that eliminates shaking and vibration in a short time. Most inexpensive telescopes below an 80mm aperture come with wobbly tripods that will defeat your goal of taking quality photos especially if even the slightest wind is blowing. The astronomer's rule-of-thumb is that you want the largest aperture you can afford for the greatest light-gathering ability to see faint objects. The goal, even when you are stacking images, is to have individual images with the longest possible exposure times so that you can achieve over-all exposures after stacking longer than 5 minutes or so. A large aperture will let you take individual 30-sec exposures or longer so that you rapidly reach very long total exposure times to detect faint objects and features. Large apertures also have better resolving ability for fine details, small craters etc. Today, the 200mm (8-inch) reflector is the most common astrophotography telescope that is also still rather portable even in a small car. Serious amateurs prefer apertures greater than 300 mm (12-inches) that are transportable in small vans or trucks, or permanently fixed in backyard observatories.

The mounting is very important. Large inexpensive telescopes use the 'Dobsonian' mounting but this cannot be used to track stars across the sky as Earth rotates. Equatorial or fork mounts, however, often come with 'clock drives' that can be set up to accurately and automatically track an object, thereby building up significant total exposure times exceeding an hour every night for deep sky objects such as nebulae or galaxies.

The Orion 8-inch *SkyView Pro* f/4.9 equatorial reflector costs \$600.00, does not come equipped with a clock drive, but has slow-motion knobs that will help you track the object. However, you will need to sight through the eyepiece to do this, so the smartphone will have no access to the eyepiece. You can, however, strap the camera to the telescope tube and track the sky through the eyepiece for some impressive wide-angle constellation shots that are far deeper than

want you can get with a tripod alone. For example, you can take 10, 5-minute hand-guided exposures and get the same results as taking 300, 10-second exposures on a tripod! The Celestron Advanced VX8 SCT LXT at a cost of \$1,600.00 is an 8-inch telescope on an equatorial mount that does automatically track the sky. It also has a computerized ‘goto’ feature where you simply type in the name of an object and the telescope swings across the sky to target the object. With telescopes, there are some basic mathematical considerations you need to understand.

Magnification – The ratio of the focal length of the aperture to the focal length of the eyepiece is the magnification. For example, a 4mm eyepiece on a telescope with a focal length of 24-inches (624 mm) will give you a magnification of $624/4= 156x$, but the same eyepiece on a telescope with a focal length of 6-feet (1.8-m) gives you a magnification of $1872/4 = 468x$. Because diffraction effects at high magnification can turn pinpoint stars into bizarre shapes, the practical limit for magnification is about 50x per inch of aperture, so a 3-inch telescope can only take a magnification of about 150x, but a large 20-inch telescope can work at 1000x and still produce ‘nice-looking’ images.



Figure 45. Figure 45. Left) The 8-inch equatorial reflector for \$600. Right) An 8-inch Dobsonian altitude-azimuth (alt-az) mounting for \$400.

Field-of-view. As you increase the magnification of the eyepiece, the angular FOV you can view decreases. You can either determine this FOV angle by looking at the moon (0.5° in diameter) and seeing how much of it fills your eyepiece, or you can calculate it using the trigonometric formula

$$\tan\left(\frac{\theta}{2}\right) = \frac{\text{Aperture radius}}{\text{Focal length}}$$

For example, a 12-inch mirror with a focal length of 6-feet will have a FOV at 1x of $\tan(\theta / 2)= 0.083$ or $\theta = 0.167$ radians or 9.5° in diameter, but if you use a 25x eyepiece, the new FOV is only $9.5^\circ/25 = 0.38^\circ$ or 23 arcminutes across.

Another way to directly measure the FOV is to time how long it takes a star to drift across the eyepiece field. The drift speed can be calculated by knowing the declination of the object, δ , using the formula

$$S = 15 \cos (\delta)$$

For example, a star at the celestial equator where $\delta=0^\circ$ has a speed of $S=15$ arcmin/minute while a star at $\delta=60^\circ$ has a speed only $\frac{1}{2}$ as great of 7.5 arcmin/min. If the star takes 5 minutes to travel

from one edge to its diametrically-opposite edge in the eyepiece, the FOV is just $5 \times 7.5 = 37$ arcminutes or about $\frac{1}{2}$ a degree – which is about the diameter of the full moon.

7.0 Star field photography

The easiest kind of astrophotography you can try is simply photographing stars and constellations. The quality of the image you get will depend on the low-light ability of the camera, and the degree to which you process the image/s. You will need a tripod and a camera adaptor to do this and get some decent pictures. But before we start this discussion, we need to talk a bit about stars and their brightness.

7.1 Stellar Magnitudes

Astronomers describe star brightness in terms of the apparent magnitude scale, which like the Richter scale for earthquakes, or the decibel scale for sound volume, is a logarithmic scale, but instead of the ‘base’ being 10 for decimal numbers, it is based on the number 2.512. This is a legacy from ancient times when stars were ‘ranked’ by their brightness with First Ranked stars being the brightest and Sixth Ranked stars being the faintest. This was then carried-over to the idea that a factor of 100 separates the (6-1=) five ranks in brightness and so $100^{1/5} = 2.512$. To calculate the brightness difference, B, between a star with an ‘apparent visual magnitude’ of +1.0 and one at a magnitude of +15 you simply treat these as exponents so that $B = 100^{(15-1)/5} = 398,107$. A 15th magnitude star is then about 400,000 times fainter than a 1st magnitude star.

As it turns out, we live in a very kind universe where there are far more faint stars than bright stars in the sky, which you have probably already noticed. Table 2 shows how this tally increases across the whole sky as you go to fainter magnitudes. It is based on the *Millennium Star Atlas*, Volume I, Sky Publishing Corporation and European Space Agency and a convenient tabulation by Haworth (2020).

Table 2. All-sky counts of stars to different limiting magnitudes.

Magnitude	Cumulative	Magnitude	Cumulative
-1	2	+8	77,687
0	8	+9	217,689
+1	22	+10	626,883
+2	93	+11	1,823,573
+3	283	+12	5,304,685
+4	893	+13	15,431,076
+5	2,822	+14	44,888,260
+6	8,768	+15	130,577,797
+7	26,533	+16	379,844,556

From this table, the number of stars you will see in your constellation photograph will depend on the seeing conditions, which determines your local limiting magnitude. There are $4\pi(57.3)^2 = 41,250$ square degrees across the full sky, and the full moon occupies $\pi(0.25)^2 = 0.2$ square degrees, so if you divide the numbers in the table by 206200 you will get the average number of stars you might see in an area of the sky about the diameter of the full moon. Note that by +9m you get about 1 star within this sky area, but by +12m you get about 25, which is appropriate for areas towards the Milky Way. If you have typical suburban, light-polluted skies your best magnitude limit may only be about +3m so you see a few hundred stars across the entire sky from both hemispheres. But if you are in a rural area and the limit is closer to +7m, you will see thousands of stars, mostly towards the band of the Milky Way. Thanks to photography, you can do much better than a naked-eye view with a long-exposure photograph. The trick is to choose an exposure/ISO that is long enough to get more stars, but not so long that your single image fogs

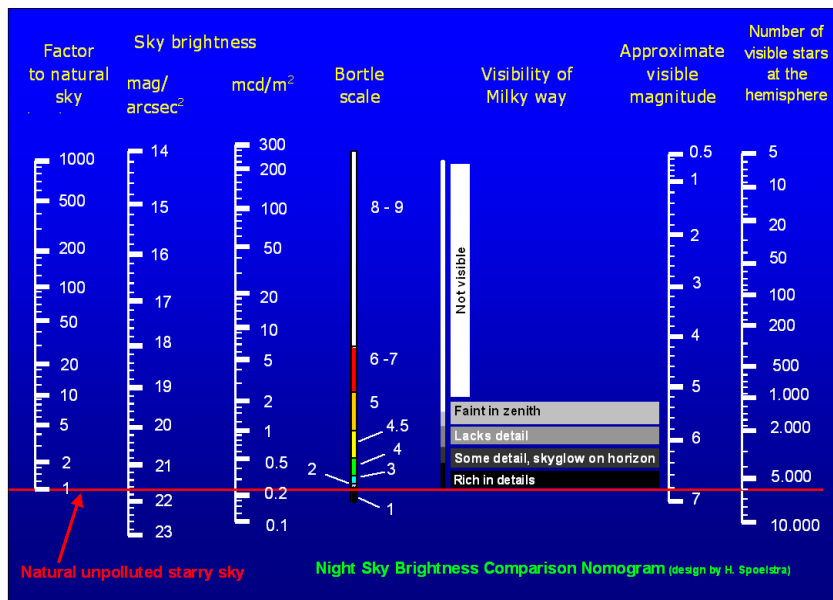

Figure 46. Sky brightness nomogram. The Bortle Scale is used to indicate sky brightness and also sky quality meters can be used for accurate photometry in terms of magnitudes per square arcsecond (mpsas). Typical suburban levels are 18 mpsas equivalent to a Bortle value of 8. For example, to find your Bortle index, look at the sky and estimate the limiting magnitude using a star chart. Draw a horizontal line on the figure above that intercepts your visible magnitude and read across to the Bortle Scale. (Credit Dark Sky Awareness)

advanced image enhancement/sharpness feature to remove ‘lens blur’, which sharpens the star images. Don’t be afraid to be as aggressive as you want with your pictures. You are taking them for their beauty and not for some deep scientific purpose where fidelity to the original data, no matter how poor, is paramount.

7.2 One-shot wonders without a tripod

Unless you use one of the better phone cameras, hand-held photography limits you to less than one second exposures at high ISO to capture enough light and faint stars but not corrupt the image with

up with the sky’s light-polluted background, or the star images become excessively trailed due to earth’s rotation.

In suburban Maryland near Washington DC, which is a highly light-polluted area, you are lucky if your naked-eye limiting magnitude is fainter than +3.0m, but with a smartphone and a camera setting of 10 seconds and ISO 800, you can easily reach +8.0m for a much nicer picture, especially after you use *Photoshop* to adjust the background brightness and contrast. It even helps, slightly, to use the *Photoshop*

a shaking camera. The exception is for bright objects viewed through a telescope eyepiece such as the moon. Successful, un-jittered photos of the moon can be taken at sub-one second exposures by simply holding the phone up to the eyepiece lens. Another subject is the Northern Lights, but their clarity is always improved by a steady tripod!



Figure 47. The Orion constellation region taken at 1-sec and ISO-2000 using a hand-held **iPhone 6s** camera and the *Camera+* app.

7.3 With a tripod – Now that’s more like it!

On a November morning at 6:00 AM I went outside during the last-quarter lunar phase, with a sky that was slightly overcast with high, thin clouds. The stars in Orion were clearly visible to the naked eye, but no stars were seen elsewhere fainter than about +3m because of the moon and haze. I wanted to see just how well my iPhone 6s phone could photograph the stars under typical suburban conditions. Figure 47 shows the first of these attempts. Sirius (-1.4m) was dazzling. Betelgeuse (+0.42m) was noticeably red, and the faintest star was Procyon (+2.7m), but other stars were visible to the eye but not many more. Note the cloudiness illuminated by city lights between Procyon and Sirius. The stars Gamma Geminorum (+1.4m), Bellatrix (+1.6m) and Pollux (+1.1m) were also visible. So, under these crude, hand-held, and cloudy conditions I could photograph stars down to about +2.7m.

This was not very impressive considering that the majority of the constellations in the sky have stars fainter than this! But I was actually surprised that the smartphone could see stars at all, and so a few days later I did another photography session at 3:00 am, and under cloud-free skies typical of ‘clear’ suburban conditions. This time, I used my Nikon D3000 DSLR camera on a tripod, and used my smartphone camera bracket to avoid shaking the smartphone during the exposure. With the Nikon on the tripod, and a 15-second delay timer to eliminate camera shaking, I took a 30s exposure at ASA 800 with the camera’s 18mm lens set at its minimum f/4 stop. The result is shown in Figure 48.



Figure 49. The picture to the left was photoshopped slightly to darken the sky and increase the star contrast. The faintest stars had a magnitude of λ Ori with a magnitude of +3.5, but the stars in the shield π 3, π 4 and π 5 are +3.1, +3.7, +3.7. Also π 2 is faintly visible at +4.3. The limiting magnitude seems to be +4.3.

Figure 48. The Pleiades field below was shot at 30 seconds near the zenith with far less haze than for Orion, F/4 ASA 800 with the Nikon.

Based on the Hyades cluster map, σ and ρ Tauri are both visible at +4.7m. The faint Pleiades star Pleione at +5.0m was barely visible in an enlarged photograph, so the limiting magnitude of this field is about +5.0m. The bottom line is that 30-second photos with the Nikon can indeed produce beautiful suburban astrophotos down to a magnitude limit near +5.0m, just slightly above the typical human limit of +6.0m. Since these are not used scientifically, feel free to *Photoshop* the heck out of them to get the appearance you want!

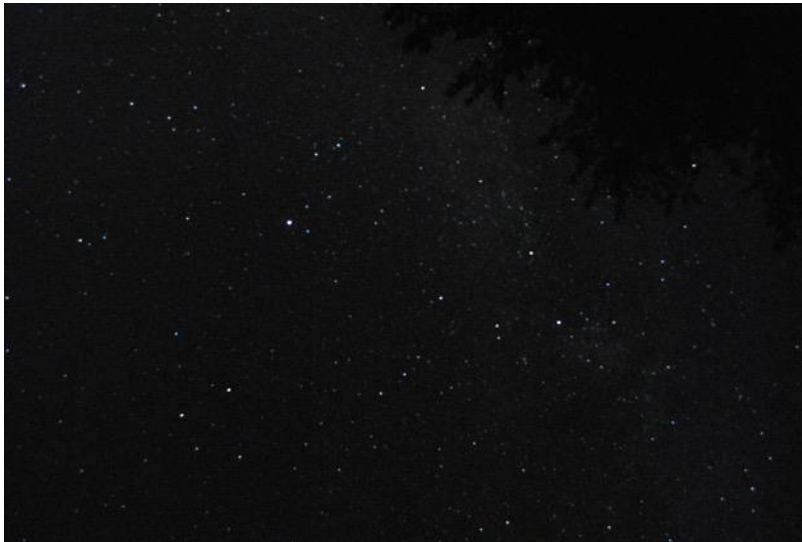

Figure 50. As a comparison, to the left is a 30-second exposure of the zenith sky taken under near-perfect conditions far from city lights in rural Vermont on September 15 with the Nikon set at ISO 800. The limiting magnitude for the stars in this series was +8.0m.



Figure 51. Orion taken with an **iPhone 6s** and the *Camera+* app at 4-seconds and ISO 800.

The smartphone was then used to take a series of photographs at ISO 800 to match the Nikon photographs, and with exposures of ½, 1, 2, 3, 4, 6 seconds. The comparable image with the Nikon was found to be 4-seconds at ISO 800 and is shown in Figure 51. Aside from the increase in the sky/array background in the ISO 2000 image, the faintest stars

discernable by the iPhone 6s still seem to be +3.0m because the Orion shield stars are not visible, nor is λ Ori (+3.3m).

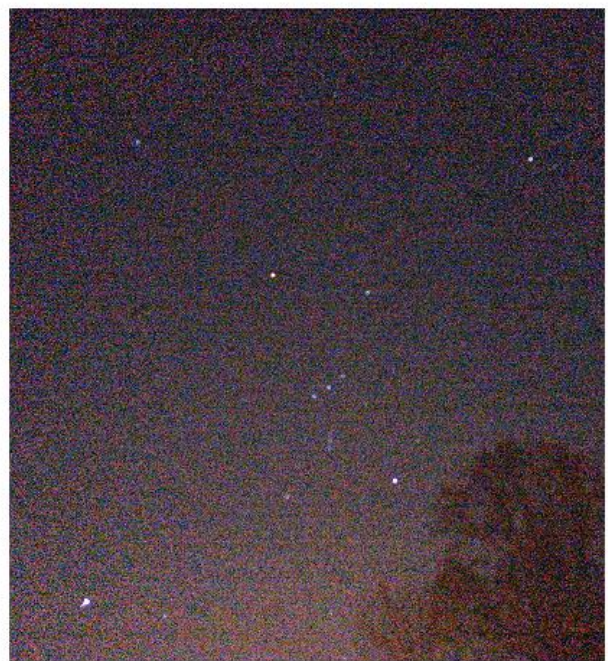

Figure 52. To check on whether increasing the ISO of the **iPhone 6s** with the *Camera+* app made any difference, I took one picture with the smartphone at 2 seconds and ISO 800 (left) and 2 seconds at ISO 2000 (right) to compare. Notice how the increased ISO brings out the graininess (pixel noise) in the image.



Figure 53. Left) Stacked **iPhone 6s** images; Right) Photo with an **iPhone 7** using *NightCap* app (Credit Daryl Olszski)

To see if the stacking method made a difference, I took a series of 16 images of Orion with the iPhone 6s set at 2sec and ISO 800. I also used the *DeepSkyStacker* program to load, register and ‘co-add’ the 16 images. The result is the following image in Figure 53 (left). The sky background is cleaner as expected because of the $\sqrt{16}$ reduction in the pixel noise, but the process achieved no significant improvement in the number of stars.

The limiting magnitude of the stacked iPhone 6s image is still about +3.0m. A similar effect is obtained using the *NightCap* app on an iPhone 7 shown in Figure 53. For the stacked Nikon image (Figure 54 top left) I used 4% star detection threshold. The pictures were 10 images at 30 sec 800 ISO each. The file was in TIFF format and it was 50 mbytes large and the final image was converted into a jpeg file.



Figure 54. A variety of Orion images processed and stacked by different camera systems. Top left Nikon, Top right **iPhone 6s** and the *Camera+* app, bottom left **Galaxy S8** with Native app and Bottom right **Galaxy S9+** with Native app.

I registered and stacked the corresponding iPhone 6s images (Figure 54 top right) with the *DeepSkyStacker* star threshold set at 6%. I also used a Galaxy S8 phone but the results (Figure 54 bottom left) were the same as for the iPhone 6s. Next, I used a much newer Samsung Galaxy S9+ and re-performed the Orion photos from the same suburban location and seeing conditions. The difference from the iPhone 6s (Figure 54 bottom right) was quite spectacular and similar to the

Nikon image. The limiting magnitude with the newer Galaxy S9+ is +6.0m. The background sky is un-pixelized with noise, and this picture required no stacking at all.

The bottom line is that with the right smartphone camera, notably the newer models with improved faint-light capability, you will easily get some impressive sky photos even under light-polluted conditions. Imagine how much better they will look far from city lights! Now let's look at some examples of stacked images produced by astrophotographers on some of the newer camera models and under dark-sky conditions.



Figure 55. Orion with a **Pixel 3 XL** - *Night Sight Astro* mode - Edited in Snapseed (Credit John Taylor)



Figure 56. Orion and Pleiades. **Samsung Note 10+** using *Night Mode* with editing color and saturation and cropping just the sky. (Credit Geoffrey Baker).



Figure 57. Orion - Single shot from **the LG G8S** f/1.5 lens 30 second exposure at ISO 800 edited in *Photoshop* from Breckenridge, New Zealand. (Credit Christian Harris).



Figure 58. Milky Way with **LG G5** one image ISO 200, 30-sec exposure (Credit Luis Delgado Gallardo)

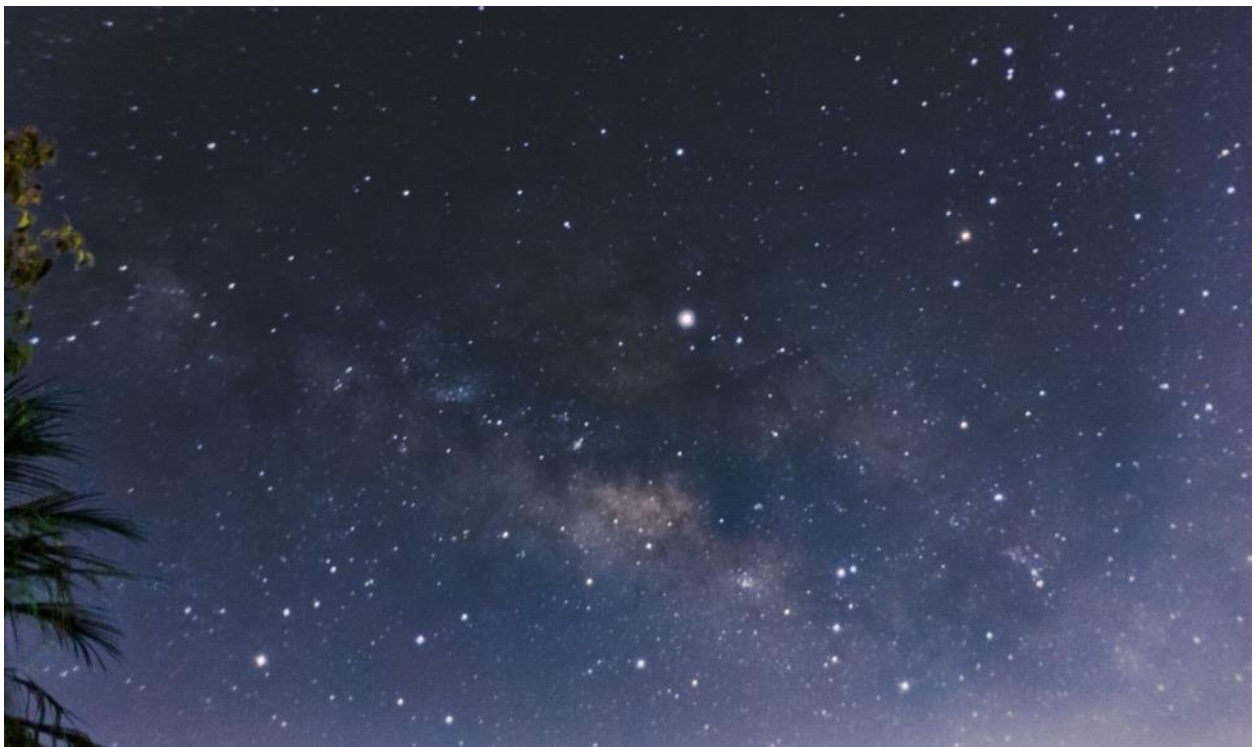

Figure 59. Milky Way with **LG G5** at ISO 200 30-sec with Procam X app and 16 images stacked. (Credit Luis Delgado Gallardo)



Figure 61. The Milky Way taken with a **OnePlus 5T 1** phone in Pro mode, 30 second unguided exposure at ISO 800 and edited with *Photoshop*. (Credit Giovanni Fabio Salerno)



Figure 60. The Eta Carina complex photographed from Bonegilla Australia with a Meade LX 65, SCT 8-inch goto telescope and a Televue Nagler 13mm type 6 eyepiece. **Samsung Galaxy S10+**, 30 sec at ISO 800. (Credit Mathew Shields)



Figure 62. The Milky Way taken with a **Samsung Galaxy S20 Ultra** on a tripod at 1600 ISO and exposure at 32 seconds. Processed to make the photo darker with contrast. (Credit Gabriel Clarke)

7.4 Star Trails

Some astronomers work very hard to create deep photographs of the sky where the star images are as point-like as possible, but of course the Earth keeps rotating and this inevitably causes star images to trail. So astrophotographers have two options; you either purchase a clock-driven mounting to follow the movement, or you take photographs that are short enough that no trails are seen, and then stack a lot of these to get a long-exposure to bring out the faintest stars. Other astronomers ‘go with the flow’ and find value and beauty in these trailed photographs! My first photos as a teenager in the 1960s were of star trails, and with smartphones you can do a whole lot better than my primitive (but personally inspiring!) attempts.

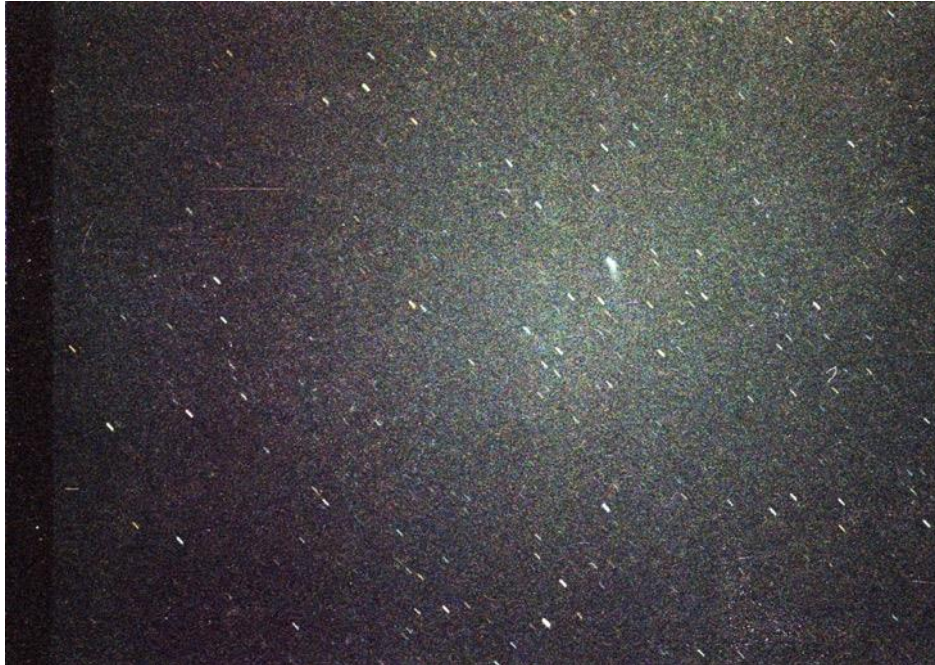

Figure 63. An example of a star trail photo using a Mamiya-Sekor 500 DTL on a tripod, and ASA-400 Tri-X film with an exposure of 15 minutes. The fuzzy blob to the right of center is Halley's Comet when it appeared in 1986.

It is a matter of mathematics how long a star image will be and this can be calculated for any smartphone camera or telescope combination by knowing the declination of the object, δ , and using the formula

$$S = 15 \cos(\delta)$$

For example, a star at the celestial equator where $\delta=0$ has a speed of $S=15$ arcmin/minute while a star at $\delta=60^\circ$ has a speed only $\frac{1}{2}$ as

great of 7.5 arcmin/min. You now need to know the scale of your image from its tFOV and the array pixel format or from the calculations in Chapter 21.1 for the camera FOV.

The constant movement of celestial objects across the sky leads to some challenges for astrophotography, especially for photography of stars as points in the sky. The longer you set your exposure, the more stars will move in your photograph and become distorted into ovals or long streaks. It is strictly a matter of geometry and mathematics how long these streaks will be and the resolution of your camera and telescope system. Astrophotographers use the *500-Rule* to set the maximum exposure time, but things are a bit more complicated than this. In fact, for every sky declination there is a separate but analogous rule, as there is for what you will photograph through the eyepiece of a telescope. The angular speed equation $S = 15 \cos(\delta)$ amin/minute is the basis for this calculation.

There is little doubt that for these simple photos, the newer smartphones that offer low-light photography are superior to older models, and for very little effort requiring only a camera tripod, you can create a seemingly endless gallery of amazing and beautiful photographs. You can use them to track satellites, capture meteor showers, and even investigate a variety of sources of light and aviation 'pollution'.

First do some research to set up your compositions and take a few images to see how many stars you will have in your final photo. Choose your widest aperture (like f/1.8 or f/3.5), a 30 second shutter speed, and a mid-range ISO like 800-1600. (Newer cameras have less noise at

higher ISO values, but you may want to use an ISO of 400 or 800 with an older or entry-level camera.) Turn off the autofocus and use manual focus set to focus on ‘infinity’. Your previous test images will tell you if you are properly focused or not. Once you know the best ISO, exposure speed and scenery composition, there is software designed specifically to create star trails images from your collection. These let you set up the ISO/exposure for an individual frame, and then use an internal timer to take the series of photos automatically over the start and end times you specify.

Star Trails – (Startrails.de) created by Achim Schaller is a freeware program that lets you easily combine hundreds of individual photos taken over a span of time into a star trail image. Taking the images is easy, stacking them (usually about 200 to 300 images) in *Photoshop* is not too much fun. You can load the images and optionally some dark frames (will be averaged and subtracted automatically if exist). If there are some images you don't want you can uncheck them. Optionally you can average some of the images to get a better signal to noise ratio for the sky-background or the foreground. This averaged image is brightened internally and at the end of the processing blended in "lighten"-mode into the resulting image. The resulting image can be saved in Jpeg, TIFF or BMP format.

StarStax (<https://markus-enzweiler.de/software/starstax/>) is a fast multi-platform (Mac, Windows) image stacking and blending program written by Markus Enzweiler, which allows you to merge a series of photos into a single image using different blending modes. *StarStax* also has advanced features such as interactive gap-filling and can create an image sequence of the blending process that can easily be converted into time-lapse videos.

With older film cameras, the camera would be on a tripod with a shutter-release cable attached to the exposure button. You would set your focus at ‘infinity’ and select the ‘B’ setting on the exposure wheel. Then by depressing and locking the shutter release cable knob, the film would be exposed for as long as you kept the cable locked. The challenge was that for a decent 3-hour exposure, the sky brightness would steadily increase on the film so that the sky was always a milky white with the star trails covering them. These long exposures were only attempted in locations where the sky was completely dark, usually far from city lights. Digital cameras let you take individual images every few minutes with exposures that minimized sky fog, and these hundreds of exposures could then be combined with software to produce the final, trailed image with very dark background skies.



Figure 64. Star trails with an **LG G5** phone on a tripod; 152, 30 second exposures (total time is 1.26 hours) at ISO 100, combined with *Star Trails* software. The jittery trails resulted from manually triggering each exposure and not using an intervalometer or timer. (Credit Luis Delgado Gallardo)



Figure 65. Star trails using a **Huawei P20**, and a cumulative time of 3-hours (Credit Donald Noor)

8.0 Photographing the Moon

By far, the most popular astronomical object for astrophotography is our own moon. It can be photographed during the daytime or nighttime and is readily accessible to most cameras even without telescopes.



Figure 66. A fall early-morning gibbous moon with an **iPhone 6s** and the *Camera+* app auto settings at ISO 25 and 1/578 sec exposure. Some mare markings are discernable.



Figure 67. Moon through a *Camkix* 12x clip-on telephoto lens with a 20-mm aperture autoset by **iPhone 6s** and the *Camera+* app to at 1/300 sec and ISO 25. Note the tree branch in foreground.



Figure 68. Hand-held **iPhone 5s**; 80mm refractor; 20mm eyepiece. (Credit Chris Woodcock)

The addition of a small telescope does wonders for producing amazingly clear and crisp pictures even with smartphones that are many years out of date. This is the direct benefit of working with a very bright object where there is plenty of light available to overcome the noise in the camera arrays.

At this point, whether you are using a smartphone or an expensive DLSR, the photographic outcome is essentially the same. The only limitation is the size of the telescope and your choice of exposure and ISO to eliminate image motion and jitter. Even holding the smartphone lens against the eyepiece and shooting at a fast-enough exposure is very effective in eliminating hand jitter. The only remaining issue is getting a

good crisp focus with your camera, however if you position your camera auto focus window on the crisp edge of the moon, it will automatically produce the best focus for you.

Although hand-held images are fun to take at the spur of the moment, you should seriously consider the purchase of an inexpensive eyepiece adaptor. Once you have mounted the smartphone camera and aligned the lens with the telescope eyepiece, the real-time camera display actually lets you share the eyepiece view with a small audience. Also, you can see the progress of the camera's auto focus system as you turn the eyepiece focusing knob to get the best possible focus for the telescope. As telescope size increases, so too will the ability to see finer details, smaller craters and subtle coloration changes, which the camera can easily recognize and photograph as you scan the telescope across the lunar disk.

A general tip about lunar photography is to avoid the full moon if you want the most dramatic pictures. The reason is that the shadows on the surface virtually disappear except at the rim of the moon, and so many photographers favor crescent or half-moon phases where the terminator shadow and low sun angle create dramatically long shadows that help reveal details.

When the moon is photographed through an 8-inch or larger telescope, the images are quite dramatic thanks to the improved angular resolution of the telescope. Under the best seeing conditions, and using Moore's Law $d = 9/D$ where d is the crater diameter in miles, and D is the aperture size in inches, an 8-inch aperture (\$500) can see craters and features on the moon only about one mile across, while a larger 20-inch telescope (\$3000) can resolve details as small as 0.5 miles. For lunar studies, you can literally assign a price to seeing details at a given scale that depends on the cost of the telescope you need to buy! If you want to double the resolution you may have to multiply the cost by about 6-fold.



Figure 69. Moon with a 4.5-inch Orion *StarBlast* reflector and a **Galaxy S9+** and Native app with auto settings at 1/250 sec and ISO 64, and using an eyepiece adaptor to hold the phone.



Figure 70. Moon image taken with the native **iPhone 7** camera app, Skywatcher 130-mm telescope and a 10-mm Plössel eyepiece. (Credit Guy Shimon)



Figure 71. The crater Gassendi. Orion 6-inch telescope and Samsung **Galaxy s10**; Eyepiece 12-mm. A total of 559 frames were stacked using *Autostackart*; with post-processing in *Photoshop* (Credit Michael Armentrout).

The main difficulty with lunar photography is the standard problem with all astrophotography. Our atmosphere jitters causing images to twinkle so you need to have some way to work around this effect. Often astronomers seek out the best observing sites in the mountains where most of the disturbances are in the atmosphere below your elevation. Also, they use high-speed imagers to capture those brief millisecond-long moments when the atmosphere is perfectly calm. Astrophotographers can do a similar thing by working with video shots of the moon and extracting the best video frames for further processing and stacking. For low resolution shots, it can simply be as demanding as just snapping a photo through the eyepiece and doing a bit of *Photoshop* work to sharpen the image.



Figure 72. Moon with a Celestron NexStar 8-inch telescope using an **iPhone 11pro** set to 1/94 sec and ISO 125. (Credit Rob Wood)



Figure 73. A single shot of the moon with an Orion XT8 8-inch telescope and **iPhone XS**. (Credit Spencer Collins)

9.0 Photographing the Planets

Planetary photography is best left for the larger telescope systems if you want to see dramatic details. Apertures smaller than 6-inches (152 mm) will show you glimpses of the large blotchy Martian surface features, a few prominent bands in the atmosphere of Jupiter, and the rings of Saturn. There is no reason, however, why you cannot use your camera by itself to photograph rare planetary conjunctions. When viewed against the twilight sky they can make for spectacular pictures.



Figure 74. Left) Conjunction of Venus and Jupiter on November 25, 2019 with a Samsung **Galaxy S9+** and native camera app, manually set at 1 second and ISO 640 looking due-west 30 minutes after sunset. Right) The Moon-Venus conjunction, May 17, 2018 (Credit Sean Wood)



Figure 75. Left) Moon, Venus (left) and Jupiter (right) conjunction on November 28, 2019 taken with a hand-held, Samsung **Galaxy S9** at ISO 1250 and 1/2 seconds. (Credit Stacey Jones). Right) The appulse of Venus and the Pleiades on April 3, 2020. Taken through a Celestron PowerSeeker 70mm with a 15mm eyepiece and a Huawei P30 Pro phone at ISO 1600 (Credit Wilfred Susaya).

If you really want to see planetary details ‘pop’ you need larger telescopes. The method of taking these photos for the best results are also complicated and resemble what you have to do to get deep star field and constellation photos. The transparency and the seeing conditions of our atmosphere change from second to second and even faster. This causes blurring in the image that

make details smaller than about one arcsec very difficult to photograph. The human eye can keep up with many of these rapid changes so your naked eye may see fleeting details in Jupiter's atmosphere through the eyepiece that may get smeared out or even vanish if you try to photograph them. Astronomers use very large telescopes to provide lots of photons, and then take dozens of photos every second to keep up with atmospheric scintillation. They then throw away the bad photos and stack the rest, just as we did with constellation photography.



Figure 76. Jupiter – Left) 7 images stacked; **Redmi 3s prime** phone with adapter; 12-inch Dobsonian telescope with a 9mm Plössel eyepiece. (Credit Bhushan Karmarkar); Right) Orion 6xt 6-inch telescope with a 12 mm eyepiece shot with a **Galaxy s10** and using a moon filter from a video series with the Native camera. It was edited in PIPP (cropped), stacked in *Autostackert* (790 frames) and post-processed in *Photoshop* to adjust color saturation and sharpening. (Credit Michael Armentrout).

Astrophotographers can actually do the same thing with their smartphones. Figure 76 (left) shows Jupiter through a 12-inch (304-mm) telescope using seven images that are aligned, calibrated and stacked. The one in Figure 76 (right) shows a picture with a much smaller 6-inch (152-mm) telescope but using 790 images obtained from the smartphone's video stream. To perform this process here's what you need to do.

Smartphone video can produce a single AVI file consisting of 7200 individual frames (2 minutes at 60 frames-per-second). The time interval between frames is 1/60 sec or 17 milliseconds, which is fast enough to keep up with most types of atmospheric scintillation. Next you have to export this AVI file into a desktop software package like *PIPP* (Windows) which will extract and crop each image frame, selecting only the best quality frames and made ready for stacking by software such as *Registax*. *Registax* does not handle AVI files with that many frames but can easily handle 1500 pre-processed bitmap files.



Figure 77. Left) Jupiter shot with an **iPhone 7** through an 11-inch Schmidt-Cassegrain telescope at f/10. The native video mode at 60 frames-per-second was used, and the 60 individual frames were selected and stacked using *Autostakert 3*, then Photoshopped. (Credit Scott Dearing). Right) Saturn - Taken with a **LG Q7+** phone through a 6-inch Dobsonian telescope. (Credit Drew Henry)



Figure 78. Left) Venus on Feb 25, 2020. Samsung **Galaxy S9 Pro** made through a Celestron 127SLT Nexstar, 32+15mm Vixen; Handheld; Holland (Credit Armand Wiersema). Right) Jupiter and moons - Single frame with an **iPhone XS**, hand-held to a 10mm eyepiece and 2x Barlow on an XT8. (Credit Spencer Collins).

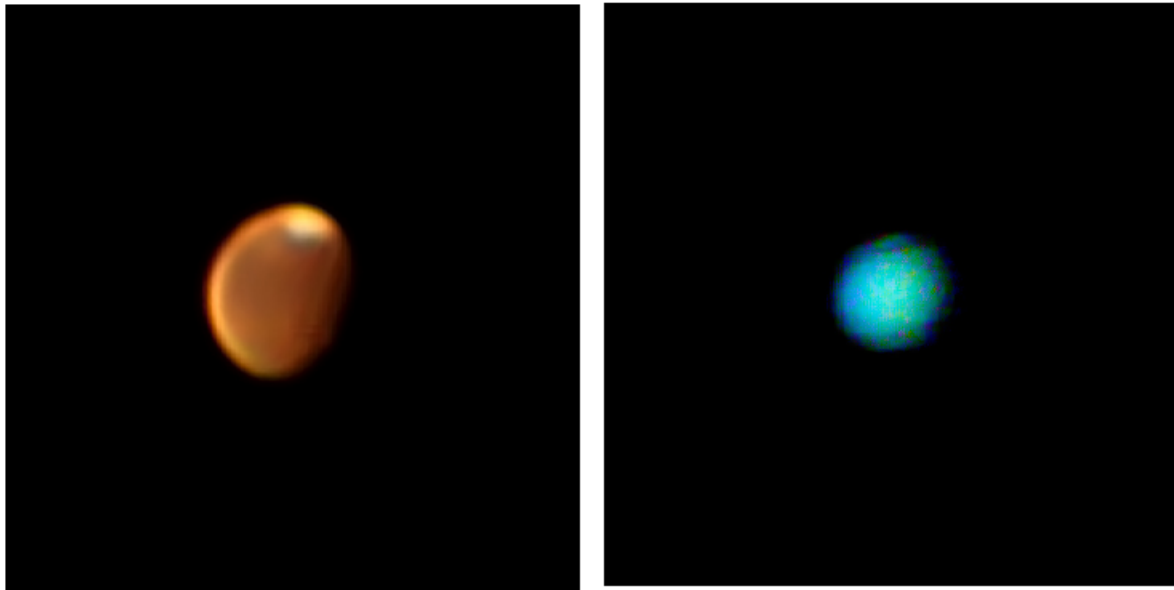

Figure 79. The planets Mars (left) and Neptune (right) taken through a Nexstar 8se telescope with a 6mm eyepiece and 2x Barlow, and with a **Samsung Galaxy S9**. Mars was taken at ISO 100 with a speed of 1/30 sec and Neptune at ISO 800 and 1/10 sec. (Credit Anderson Vieira)

10.0 Photographing Deep Sky Objects

Deep-sky objects (DSOs) are a mixed bag of astronomical objects including open star clusters such as the Pleiades, globular clusters like Messier 13 in Hercules, a wide range of nebulae, and objects beyond the Milky Way such as the Magellanic Clouds visible in the Southern Hemisphere, or the Andromeda Galaxy for Northern Hemisphere observers, among many other galaxies.

Photographing DSOs will be a challenge because we are constantly treated to the spectacular imagery of the Hubble Space Telescope and other large instruments, but what you will be able to achieve with large amateur telescopes will be significantly humbler in scope and detail. If you understand this particular reality, then you will find many exciting challenges for acquiring YOUR best photographs of DSOs to be proud of.

There are advantages for using small telescopes, and these are particularly apparent when photographing open star clusters, which can subtend large angular sizes exceeding the diameter of the full moon in some cases such as the Hyades Cluster in Taurus, the Pleiades (Messier 45) also in Taurus, and the Praesepe Cluster in Cancer among many others. The nearby Andromeda Galaxy (Messier 31) is many degrees across and photographing it is an ideal target for smaller telescopes that can fit-in much of this galaxy in one low-power eyepiece view. Even a few nebulae such as the Great Nebula in Orion (Messier 42) can be more favorably photographed in smaller telescopes because the fields-of-view in lower-power eyepieces allow for more of the dark background sky to be seen, which makes the contrast with the nebular material easier to see.

Medium-sized telescopes in the 8 to 14-inch (200 to 360-mm) range are the threshold instruments you need in order to start to see details in a variety of nearby planetary nebulae, supernovae remnants and galaxies within the Local Group of which our Milky Way is a member.

Large telescopes above 16-inches (400-mm) are becoming increasingly more common thanks to inexpensive Dobsonian designs and mass production. It is not unusual to find 20-inch telescopes at most amateur astronomer gatherings called Star Parties. The light-gathering ability of these instruments is so great that long-exposure photographs taken on smaller 6-inch telescopes look like what you can now see through the eyepiece in real-time on 20-inch telescopes that gather $(20/6)^2 = 11$ -times more light to form the images. It also means that, through the eyepiece you will be able to see objects about 2 to 3 visual magnitudes fainter, which usually means a lot more stars in your FOV. Through these telescopes, many of the popular galaxies and nebula can be resolved.

To actually photograph DSOs requires the careful calibration and stacking techniques mentioned earlier for planetary photography. Because nebulae can be colorful objects, it is often the case that photographs are taken separately through different filters and then calibrated, stacked and recombined to form the final image. Much of the advanced astrophotography community is dedicated to finding the best ways to reveal these natural colors through increasingly complicated protocols of how to handle the raw images to minimize the natural noise without introducing processing artifacts.

For many nebulae, astrophotographers invest in a series of filters that attach directly to the eyepiece and remove various bands in the visible spectrum that can blur the image. One such popular filter is the H-alpha ‘sky filter’ blocks out all the other light wavelengths except those around 656 nm. This includes the 589 nm line from sodium-vapor lamps. Similar filters are also available that only pass the prominent oxygen lines or nitrogen lines. If you live close to dark sites you will not need these light pollution filters in general, but from urban locations they are very spectacular in the way they lower the sky background to near-dark levels.

10.1 The Orion Nebula – Messier 42

At the time of this writing, February-March, the constellation Orion dominated the evening skies and with it one of the most incomparably beautiful nebulae in all of the sky: The Great Nebula in Orion. You can see it with your naked eye as a fuzzy blob nestled in the sword of Orion hanging below the belt star Alnitak. This nebula is bright because it is one of the closest to our sun at a distance of ‘only’ 1,300 light years. It is also powered by extremely luminous ‘O-type’ stars within a stellar nursery only about 10 million years old. These produce enormous amounts of ultraviolet light that excite the atoms in the nebula to emit red (hydrogen) and green (oxygen) light. Blue colors can come from light scattered by interstellar dust grains, and by emission from oxygen and hydrogen as well.



Figure 81. Orion nebula taken with the **Pixel 3 XL** through Celestron PowerSeeker 80AZS 3-inch telescope. Moon/Sky Glow filter on 20mm Plössel eyepiece. Google Camera PX using manual ISO and shutter speed. (Credit John Taylor).

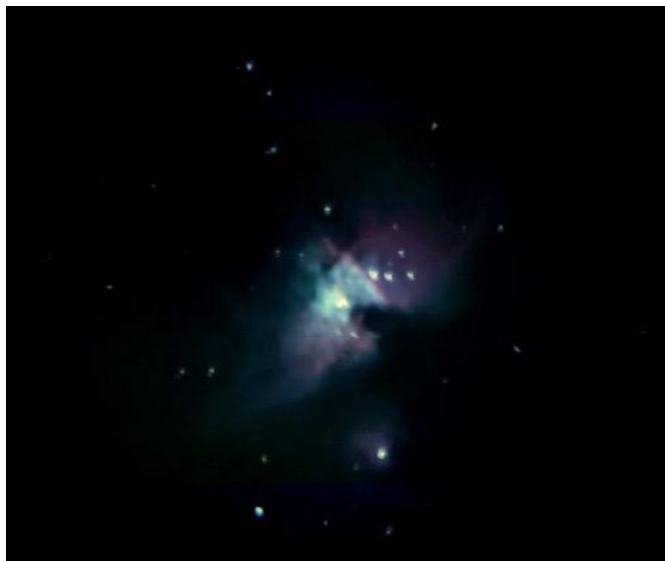

Figure 80. Orion with a **Google Pixel 3** taken through a 16-inch Meade reflector with a 40mm eyepiece. (Credit Jim Preusse)



Figure 82. Left) Orion Nebula with an 8-inch telescope and a **Galaxy s10** phone. (Credit Barel Azimtai). Right) Orion Nebula with an **iPhone 7**; 10-inch reflector; 10mm Plössel eyepiece; *NightCap* app; 7 seconds exposure. (Credit Guy Shimon)



Figure 83. M42 - Orion Starseeker 150mm (6-inch) Maksutov-Cassegrain telescope; Orion Plössel 40mm eyepiece; **LG G7 ThinQ** f/1.6 camera phone; ISO 800 (100 for the brighter core nebulosity); 20 min exposure (40 x 30-second Light Frames, 1 x 30-second for core); Dark and bias frames; Stacked in DSS; Stitched in *Snapseed*; Edited in Adobe *Photoshop* (Credit Christian Harris).

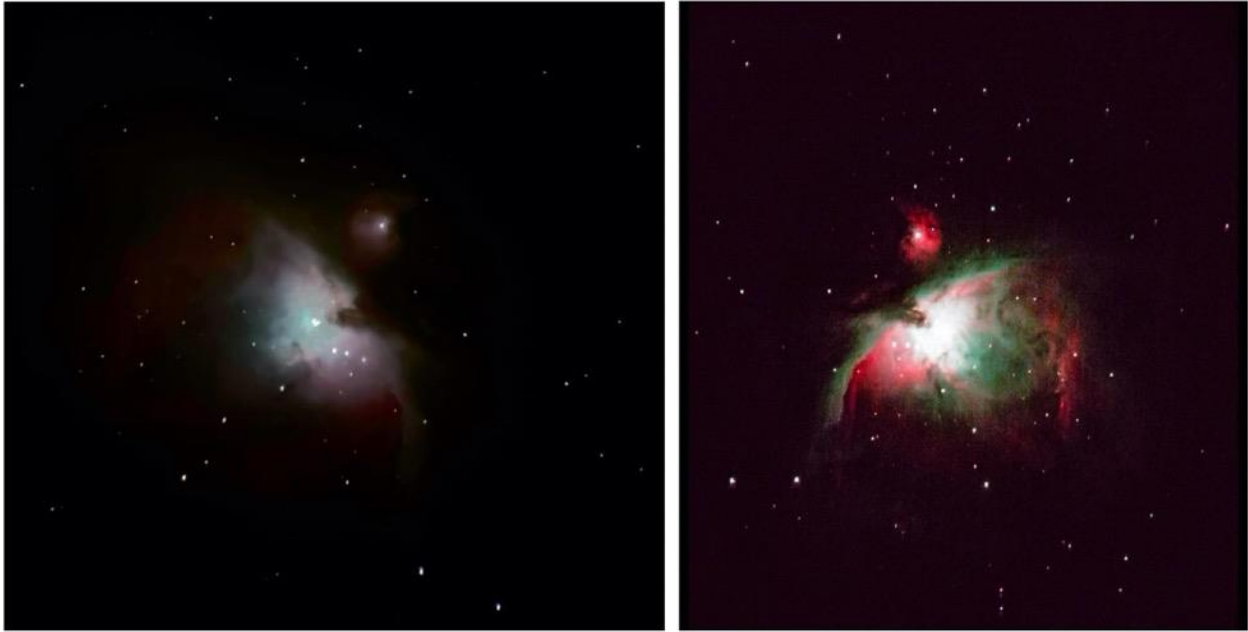

Figure 84. (Left) M42 - with a Celestron 8se through a 34 mm Orion eyepiece. Photo with an **iPhone 11max** pro with ISO 400 for 15 secs. (Credit Christine Phares): (Right) Samsung **Galaxy S9** in ‘pro’ mode; 20, 10-second exposures on the nebula at ISO 640. Ten, 10-second exposures for Darks. The telescope was a Celestron Evolution 9.25-inch; 24 mm eyepiece and an Astronomik UHC sky filter. The images were stacked in *DeepSkyStacker* and edited in *Photoshop*. (Credit Viktor Abelin).

10.2 The Pleiades

Star clusters are less demanding than nebulae. You don’t have to worry about getting color balances right or worry about twinkling effects because the stars are point sources. What is a challenge is getting clusters that fit into the FOV of your eyepiece so that they actually look like clusters and not just another enlarged sky or constellation image. Among the nicest winter-time objects is the famous Pleiades cluster in the constellation of Taurus, with its seven main stars and dozens of fainter ones. It is in fact so large and bright that you do not even need a telescope at all to get a visually interesting picture of it.

The challenge without a telescope is to have a smartphone that is sensitive enough to detect this cluster in one shot and to use a tripod to keep your camera stable. The slightest movement will elongate the star images, but also if you use exposures much above 20 seconds the stars will be elongated from diurnal motion. This distortion will appear worse when you enlarge and crop the image for a tighter view of the cluster. The beauty of photographing this cluster with only your smartphone is that you can also capture surrounding terrestrial features to ‘frame’ the picture. Also, the contrast between the spread-out stars in Taurus and the compact stars in the Pleiades is an interesting compositional effect for the photograph. With a small telescope, as Figure 85 shows, this compact cluster looks even more impressive.



Figure 85. (Left) Single exposure of the Pleiades area with a Google **Pixel 4** on a tripod and no guiding; 16 sec ISO 78. (Credit Luke Smith) (Right) Pleiades with a 3-inch refractor, a 27mm eyepiece, and a Samsung **Galaxy S8**. Two, 6-second images were stacked for this 12-second total exposure time, and corrected with Darks using *StarTools*. (Credit Paul Gibbs)



Figure 86. Pleiades through a Celestron PowerSeeker 80AZS (3-inch) refractor and a 20mm Plössel eyepiece with no filter. The single **Pixel 3 XL** image had an exposure time of 4 seconds at ISO 2616. The limiting magnitude is about +11m. (Credit John Taylor)

10.3 Other Star Clusters

There are two types of star clusters that you will encounter. The first of these are called open clusters because they have a rather large appearance with the stars scattered randomly within their apparent boundaries. The Pleiades is one example, with the stars within a roughly full moon-sized patch of the sky, but the stars themselves spread randomly within this boundary. Two very large open clusters in the winter sky are the Hyades cluster in the constellation Taurus, and the Praesepe cluster in Cancer, also called the Beehive cluster or Messier-44. The Hyades cluster located near the bright star Aldebaran is about 5° across and contains hundreds of stars. The Praesepe cluster has about 200 stars and spans about 1.5° of the sky near the center of the constellation. Open clusters are stars that formed from the same molecular cloud nursery, and the member stars all share the same motion through space within the Milky Way. They are most commonly found within the Milky Way band in the sky, but some nearby ones like the Hyades and Pleiades are close-by so appear projected against the sky at large angles from the Milky Way.

The second category are the globular clusters. These are distinctly ball-shaped swarms of thousands of stars within a span of less than 1° of the sky. They orbit the center of the Milky Way much as our moon orbits earth. Their orbits, however, can be millions of years long. Unlike the nearby open clusters, which have stars bright enough to be easily visible in the eyepiece, globular cluster stars are much fainter and are so crowded together that it is hard to see anything more than their combined diffuse glows to indicate the shape of the cluster. This is especially true when seen through small telescopes, however with larger telescopes many of the brighter stars in each cluster can be resolved. Photographically, these objects can get smeared out by atmospheric twinkling so taking numerous short-exposure photos and stacking them is preferable to taking a few, long-exposure photos.

The aperture of the telescope determines how faint the stars you can reach in one photograph will be, but at the same time, increasing the aperture reduces the FOV seen through the eyepiece and for large clusters this can be a problem. As you hunt for fainter clusters, you will want to use lower eyepiece magnifications to make sure the cluster is still contained within the FOV of the eyepiece for optimum and provide contrast with the background sky clutter. Also, refractors are better than reflectors of the same aperture size because reflectors, especially of the Newtonian design, produce spiked star images, while refractors and other ‘unobstructed’ telescopes (e.g. Cassegrains or Maksutovs) show round stars, which are more visually pleasing in photographs.

For a list of the brightest open star clusters, start with those in the Messier Catalog and then work your way to other cluster lists such as the one in Wikipedia (2020). Here are some examples of what astrophotographers have done using their smartphones and popular telescopes in the 3 to 8-inch range.

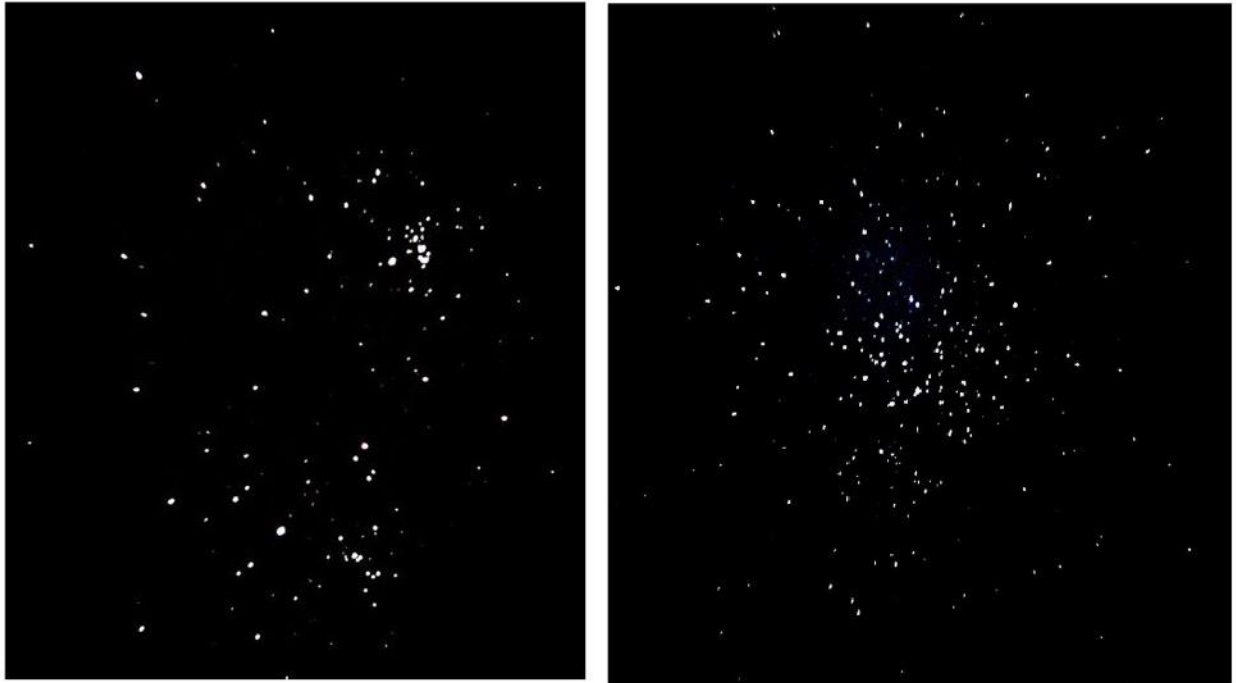

Figure 87. (Left) A 3-second exposure of the open cluster H and Chi Persei (NGC 869/884) - Double Cluster in Perseus taken with a Skywatcher 10-inch telescope and a 24mm Plössel eyepiece with an **iPhone 7** using the *Nightcap* camera app. (Right) The open cluster Messier 37 in the constellation Auriga. Taken through a Skywatcher 10-inch reflector with a 24mm eyepiece on an **iPhone 7** using the *NightCap* camera and a single 3-second exposure. (Credit Guy Shimon)

H and Chi Persei is a binary cluster located 7,800 light years from Earth, and have been known at least by the ancient Greeks. Physically, the clusters are separated by about 100 light years and were formed about 13 million years ago. Messier 37 is located 4,500 light years from Earth in exactly the opposite direction as the center of the Milky Way. Containing about 500 stars, it is an older cluster with many red giant stars and an estimated age of as much as 550 million years. Omega Centauri (NGC 5139) is a globular cluster located about 15,800 light years from earth in the constellation Centaurus. It is one of over 160 known satellites of the Milky Way, and with a diameter of 150 light years and containing over 10 million members it is the largest globular cluster of its type. It is so large compared to the other globular clusters that it may even be the remnants of a dwarf elliptical galaxy that was cannibalized by the Milky Way billions of years ago. There are many of these in our neighborhood of the universe!



Figure 88. (Left) The Owl Cluster or ‘ET Cluster’ (NGC-457) through a Takahashi FC100 4” refractor with a 24mm Panoptic eyepiece on an EQ Mount. **iPhone 11 Pro** exposure 5 seconds. Image adjusted with *Snapseed*. (Credit Stuart Davis). (Right) The open cluster Messier 11, 7” f/15 Maksutov Cassegrain telescope, Brandon 24mm eyepiece, **iPhone SE** phone, 20 exposures, 10 seconds each, ISO 10,000. Stacked with *Nebulosity 4*, processed with *Snapseed*, *Gimp*, and Apple *Photos*. (Credit Loren Ball)



Figure 89. Open star clusters: (Left) The open cluster Messier 93 taken with a Skywatcher 80mm ED refractor and a **Samsung Galaxy S7** phone. Ten images, each 10 seconds long and at ISO 500, were stacked with *DeepSkyStacker* and no calibration images were used. (Credit Jason Stromback) (Right) The Jewel Box cluster from Cape Town South Africa. Taken with a **Samsung Galaxy Note 8**, 20mm eyepiece and an 8-inch Skywatcher mounted on a Celestron CGEM mount. (Credit Marius Reitz)



Figure 90. Figure 90. Globular star clusters: (Left) Messier 28, with 90 mm (3.5-inch) Maksutov and **Huawei 3a** phone, with an 8-sec exposure at ISO 3200. (Credit Alexander Parmington); (Middle) Messier 22 127mm Maksutov, **Samsung S7**, a Plössel eyepiece. Individual, 10 second exposures, 22 images at ISO 800, stacked with *DeepSkyStacker*, stretched in *Registax*, and edited with *Photoshop Express* app and finished in lightroom app. (Credit Jason Stromback); (Right) Omega Centauri. A single one second exposure at ISO6400 with an **iPhone SE** in *Nightcap* app shot with an Orion 14” Newtonian telescope through a 25mm eyepiece (Credit Michael Dooley)



Figure 91. The globular cluster Messier 13 ‘The Great Cluster in Hercules’. 30-minute total exposure with **Huawei p20 pro** and *DeepSkyCamera* app on a 10-inch, f4.8 telescope with a 10mm eyepiece. Processing with *DeepSkyStacker*, *Gimp2* (Credit Matthijs Burgmeijer)

10.4 Other Nebulae

The Messier Catalog includes twelve bright nebula including M-42 the Orion Nebula. Each of these are bright enough to be seen in modest telescopes, and become spectacular views in larger instruments. There are also a vast number of dark clouds such as the southern Coal Sack that can be seen as black splotches against the patina of background stars along the Milky Way. Astrophotographers are slowly starting to include more of these off-the-beaten-path objects in their observing plans. As for all faint objects, stacking and calibrating are a must for controlling the artifacts of the camera and reducing the background noise. Also, many of these objects benefit enormously from the added exposure times beyond 10 minutes that can be accumulated during the stacking process. You are limited only by your patience in assembling hundreds of images by the enhanced colors and details that emerge from this process especially for the large ‘HII Regions’ surrounding stellar nurseries such as Orion.



Figure 92. Typical planetary nebulae: (Left) Eskimo Nebula viewed with a 17.5" Dobsonian telescope with a 13mm eyepiece, and photographed with an **LG V30** phone at ISO 3200 and 2-sec. (Credit Oscar Lithgow). (Middle) The Ring Nebula Messier 57. Unguided through an 11-inch Schmidt-Cassegrain telescope. Photographed with an **iPhone 7**, 25 seconds at ISO 2500. Processed with *Nightcap* (Credit Scott Dearing). (Right) Messier 27 the Dumbbell Nebula in Vulpecula, with a 7-inch, f/9.5 Maksutov Cassegrain telescope, and a Brandon 24mm eyepiece. **iPhone XR**, 30 exposures, 10 seconds each, ISO 10,000. Stacked with *Nebulosity 4*, processed with *Gimp* and Apple *Photos*. The field of view is about 0.7 degrees – a bit larger than the full moon. The limiting magnitude is about 16. (Credit Loren Ball)

10.5 Galaxies

Galaxies are among the most intriguing and challenging objects to photograph and for which there can be no such thing as a telescope that is ‘big enough’ to view or photograph them. Although many bright nebulae exist whose appearance at the eyepiece can be dramatic and pleasing, for galaxies, they never look like anything more than indistinct smudges of light, perhaps round or cigar-shaped in some cases.

In addition to star clusters and bright nebulae, the Messier Catalog of bright non-stellar objects includes 38 galaxies visible from the Northern Hemisphere and located beyond the Milky

Way. Most of these are located within the Virgo Cluster of galaxies and so are found in the constellation Virgo. Meanwhile, the Large and Small Magellanic Clouds are prominent Southern Hemisphere objects as is the famous Eta Carina nebula complex.

Galactic photography is the most demanding due to the extreme faintness of the subject matter. In almost all cases, very aggressive techniques have to be used to amplify the faint light and increase the contrast of the details. Figure 93 shows a typical sequence of steps involving the full suite of dark, flat and bias frames to remove image artifacts and reduce the noise. Although a professional-grade astrocamera is used, the techniques apply to smartphone astrophotography as well.

For the Magellanic Cloud, the master dark frame was created from a stack of 60 individual dark images with the camera lens closed off. The flats were a stack of 15 individual images using the sky as a uniform source. The individual images were 60 seconds in length including the dark frames. Each image was calibrated by dividing them by the master Flat frame (gains) and subtracting the master dark frame. The calibrated frames were then stacked using the Luminance app. Identical images were taken in red, green and blue filters and combined to create the colored final image after additional processing using *Pixinsight*.

Figure 93. (A) The Large Magellanic Cloud showing several stages of processing. This is a single raw image taken with a ASI1600MM-c astrocamera using a Samyang 135 f/2 lens. (B) This is a single raw image after dark frame subtraction. (C) This is a stacked image after darks and flat subtractions. (D) This is the final image after some additional processing with *Pixinsight*. The total exposure time was 1 hour for each color. (Credit Logan Nicholson)

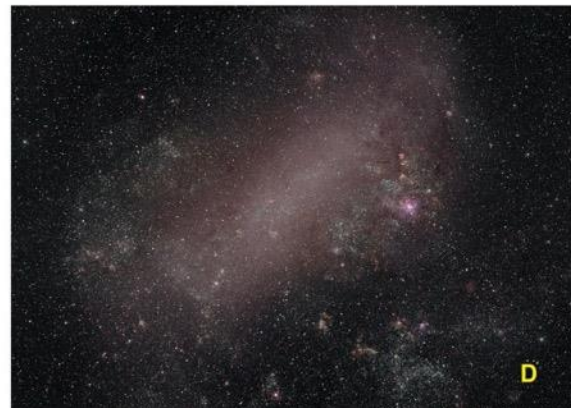

Another large galaxy that you can see with your naked eye is the Andromeda Galaxy Messier-31. Only slightly fainter than the Great Nebula in Orion, Messier-31 would actually be six times the diameter of the full moon if your eyes were sensitive enough. Here is a simulated image of it created in Photoshop.



Figure 94. Simulated comparison of the size of Messier-31 with the full moon if human eyes were sensitive enough to detect the galaxy's faint light.

Photographing this galaxy will be a challenge with smartphones but not an impossible task. Just don't have high expectations of the size and detail you will be able to capture. The problem is that the dynamic range of a smartphone camera is limited and so faint details will not be detectable above the sensor noise no matter what you. Here are some examples taken with a camera tripod and through the eyepieces of various telescopes.



Figure 96. Wide field image showing Andromeda Galaxy shot with a **Huawei P30 Pro**. ISO 1600, 25 seconds. The inset shows an enlargement. (Credit Grainge Jennings)



Figure 95. Shot on a tripod with a **Huawei P20 Pro**. Note the Pleiades at the bottom. Messier 31 is indicated by the arrow. (Credit Stefan Gruber)



Figure 97. Left - M31C Orion Observer 700/70 with an **iPhone XS Max** (Credit Doug Shelly) Right - M31G Explore Scientific 90mm f5.5 refractor with 9mm eyepiece, **iPhone 7**, *Nightcap* video. Processed in PIPP and *RegiStax*. (Credit Peter Deller)



Figure 98. The Andromeda galaxy with a Takahashi FS 60 telescope, Flattener (370mm focal length), Eyepiece: Baader Hyperion 17mm; **Xiaomi Pocophone F1**; Total exposure time: 65 min; 112 light frames each 35 sec, ISO 800; 110 dark frames; no bias frames, no flat frames (Credit Michael Seeboerger-Weichselbaum)



Figure 99. Messier 31 with a 60mm f/4.6 guide scope and a 25mm super Plössel eyepiece. Photographed with a **Huawei p20 pro**. A total of 95 individual frames, each 30 seconds at ISO 1250, were stacked for a total exposure time of 47.5 minutes. The calibration frames consisted of 50 flats, 50 darks and 50 bias exposures. (Credit Matthijs Burgmeijer)

Galaxies are a challenge because of their small diameters, only a few arcminutes across, and in many cases have detailed structure that is barely resolvable by most amateur telescopes below 20-inch apertures. Here are some images using a DSLR camera showing the processing steps used to pull out the faint details.



Figure 100. Faint galaxies benefit greatly from careful stacking and calibration to remove artifacts. In this comparison, the removal of vertical pattern noise and flattening of the sky background is evident. The galaxy is NGC 1097 taken with a Takahashi MT-160 (6.3-inch refractor) using a Canon EOS700D camera. (Credit Logan Nicholson)

With smartphone cameras it is not possible to achieve the same clarity as for images created using DSLRs because of the imaging sensor used in these cameras. As previously noted, smartphones have small pixels (1-2 microns) and very shallow pixel wells than can accommodate only a few 10s of thousands of electrons. This former issue makes them very slow to gather photons from faint objects while the latter issue limits the range of brightness that can be detected, called the dynamic range, to only 1:10000 between the brightest and faintest objects in the field. Because noise is present, the actual range of brightness is only about 1:1000. For stars, each brightness factor of 2.51 corresponds to one stellar visual magnitude, so a 1:1000 range spans only +7.5 magnitudes.

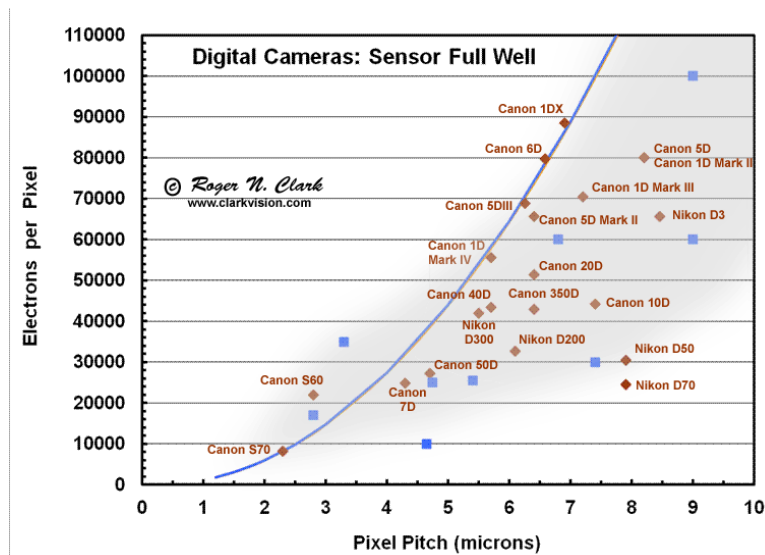

Figure 101. Pixel ‘well capacity’ of some digital camera systems. Smartphones are near the bottom of this curve with 1 to 2-micron pixels! (Credit Roger Clark)

As Figure 101 shows, for DSLRs and astrocams, their pixels can be 8-10 microns in size with well capacities of as much as 100,000 electrons for an effective dynamic range up to +10m. This dramatically cuts down not only the noise in the image but the length of time per exposure required to reach a given brightness level or stellar magnitude limit. With some aggressive calibration, however, even smartphone images can produce interesting images of DSOs. In fact, this challenge is

what drives many astrophotographers to consider using smartphone cameras. With enough effort, careful attention to the quality of individual images, and innovative post-calibration using such software as Photoshop, many of these smartphone images can rival the output from more sophisticated equipment at substantially lower cost because EVERYONE already owns a smartphone.



Figure 102. (Left) Sombrero Galaxy shot with a Samsung **Galaxy S8** through a 10-inch telescope. ISO 800 for 10 seconds. (Credit Nerida Langcake) (Right) Messier 51 with a Celestron 8-inch, auto guide. ISO 3200. 20mm Plössel. **Galaxy S10E**. Single shot. 30sec exposure. (Credit Robert Hite)



Figure 103. Messier 51 viewed through an 8-inch telescope with a 24mm eyepiece, and with an Orion Skyglow astrophotography filter. 55 photos at 30-seconds each at ISO 3200 with an **LGV30+** phone. (Credit Joey Hunter)



Figure 105. Messier 81 Bode's Galaxy (lower left) and Messier 82 the Cigar Galaxy (upper right) seen through a Meade Adventure Scope 80mm refractor. This single 15-second image with darks and flats was taken with an **LG V20** phone. (Credit Thomas-Juliana Campbell)

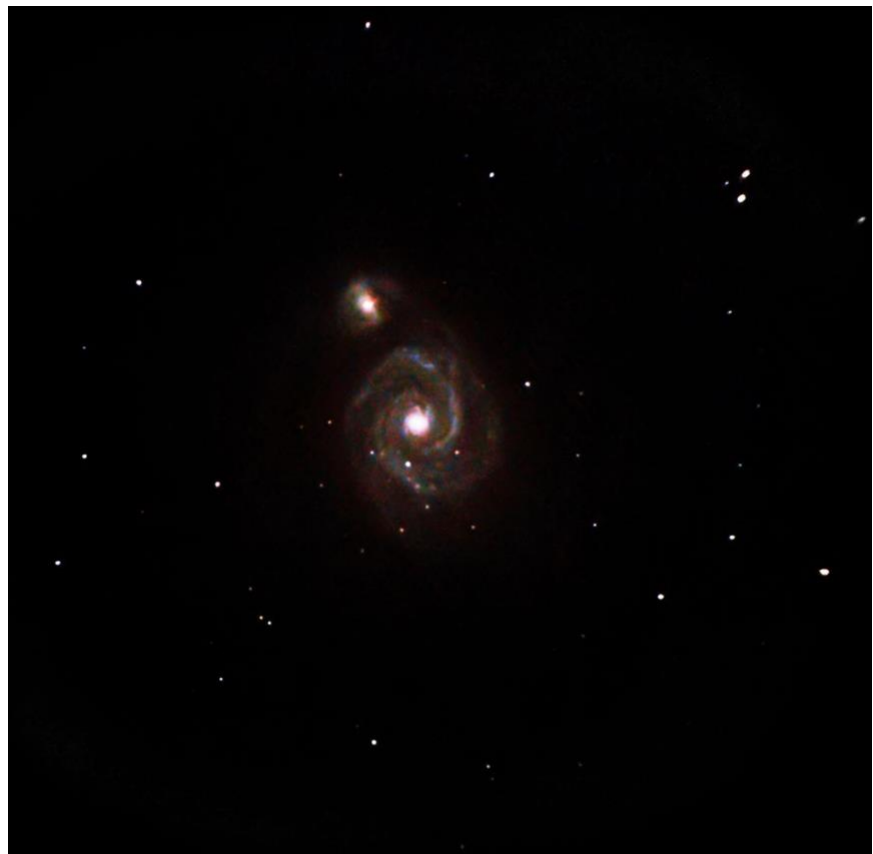

Figure 104. The Whirlpool Galaxy (M51) Celestron C9.25 with the f/6.3 reducer and Baader zoom at 16 mm. Samsung **Galaxy S9**, pro mode f/1.5 ISO 640. 34*10s lights; 24 darks, 24 flats and 25 bias. Stacked in *DeepSkyStacker*, edited in *Photoshop*. (Credit Viktor Abelin)

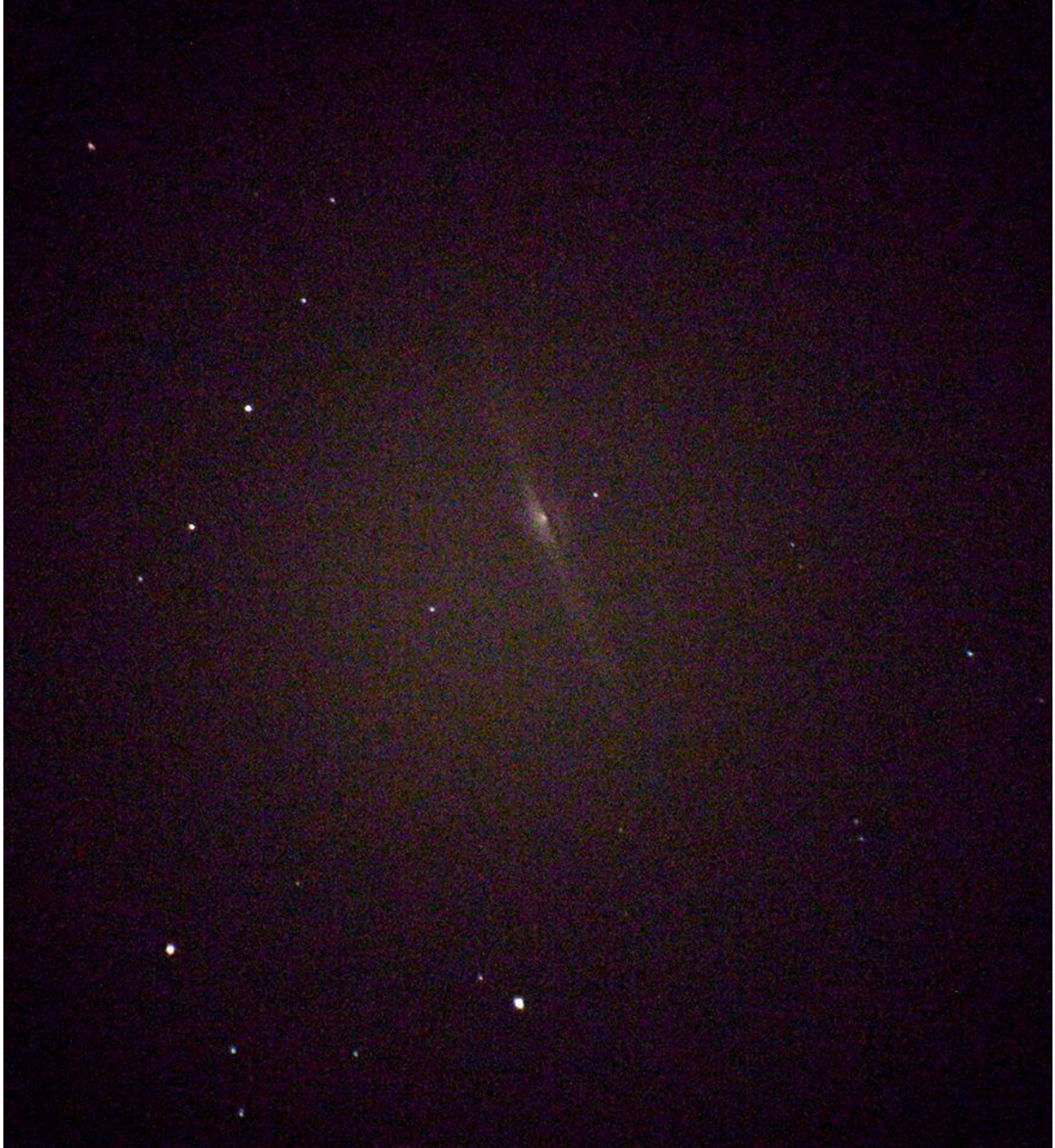

Figure 106. NGC 4565 (Needle Galaxy) using a Celestron C9.25 telescope with the f/6.3 reducer and Baader zoom at 16 mm. Samsung **Galaxy S9**, pro mode f/1.5 ISO 640. Single 10s exposure. (Credit Viktor Abelin)

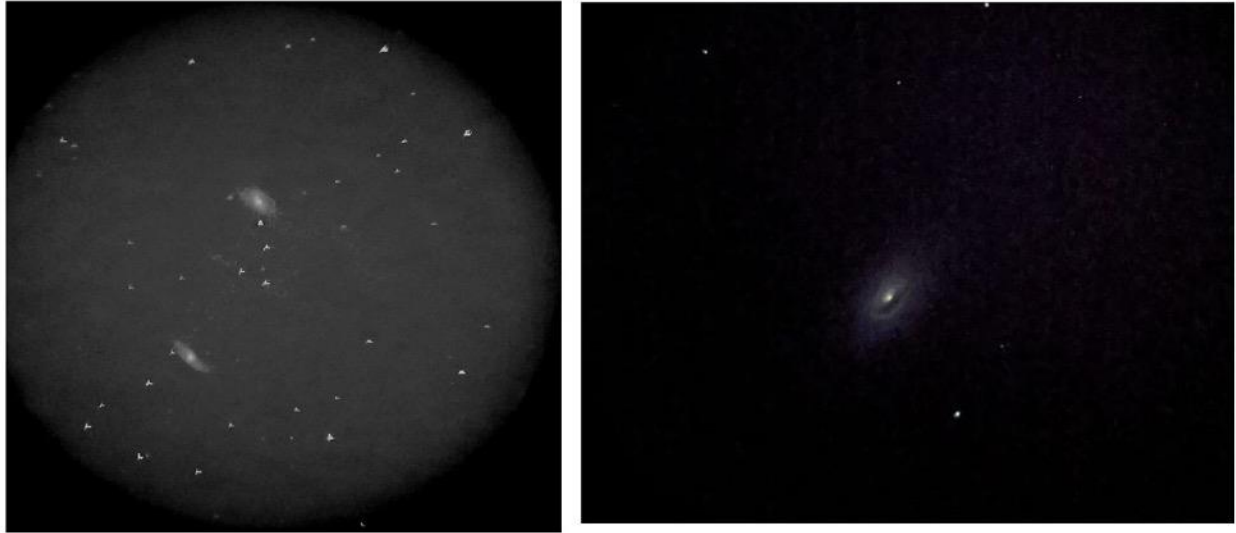

Figure 107. (Left) The galaxies M65 (lower left) and M66 (upper right) in Leo taken with a Sky-Watcher Classic 200p Dobsonian telescope using a 25mm Plössel eyepiece. A **Huawei P30 Pro** phone was used, set at 6 seconds and ISO 6,400. (Credit Ashley Irons). (Right) Messier 64 the Black Eye Galaxy, shot with a Google **Pixel 3 XL** in *Astrophotography* mode and a Celestron C11 SCT with a Vixen SLV 25mm eyepiece. (Credit Elad Schwartz)

10.6 Supernova

If you are lucky enough you may even have the opportunity to photograph a supernova! Although spectacular events such as the naked-eye 1987a supernova in the Large Magellanic Cloud on February 24, 1987 (SN1987A) was visible to Southern Hemisphere observers without a telescope, these are rare events. In spiral galaxies such as the Milky Way, the typical time between supernova is about 50 years but most of these are thousands of light years from the sun and hidden by dust clouds. As a result, we have only seen from Earth about six supernovae in the last 2000 years or so. These odds can be hugely increased with the aid of a telescope and a careful survey of the hundreds of other spiral galaxies in our corner of the universe.

Between January-July 2020, over 75 extragalactic supernovae have been detected by specially-designed telescopic surveys (e.g. <http://www.rochesterastronomy.org/supernova.html>). The breakdown of these in terms of their brightness is that four were brighter than +14.9m, another 16 were between +15.0 and +15.9m. The rest were fainter than +16.0 and difficult for most small telescopes. Recently on May 6, 2020 a massive star in the galaxy Messier 61 (NGC 4303) some 52 million light years from the sun, gave up the ghost, making it the eighth supernova (SN2020jfo) seen in this galaxy since 1972. It reached a peak magnitude of +14.6 a few weeks later making it visible in a 10-inch telescope, and then began to fade. Armed with a telescope and a lot of patience, or with periodic visits to current supernova catalogs, you can have a shot, literally, at capturing one of these events for yourself such as the M-61 supernova shown in Figure 108.

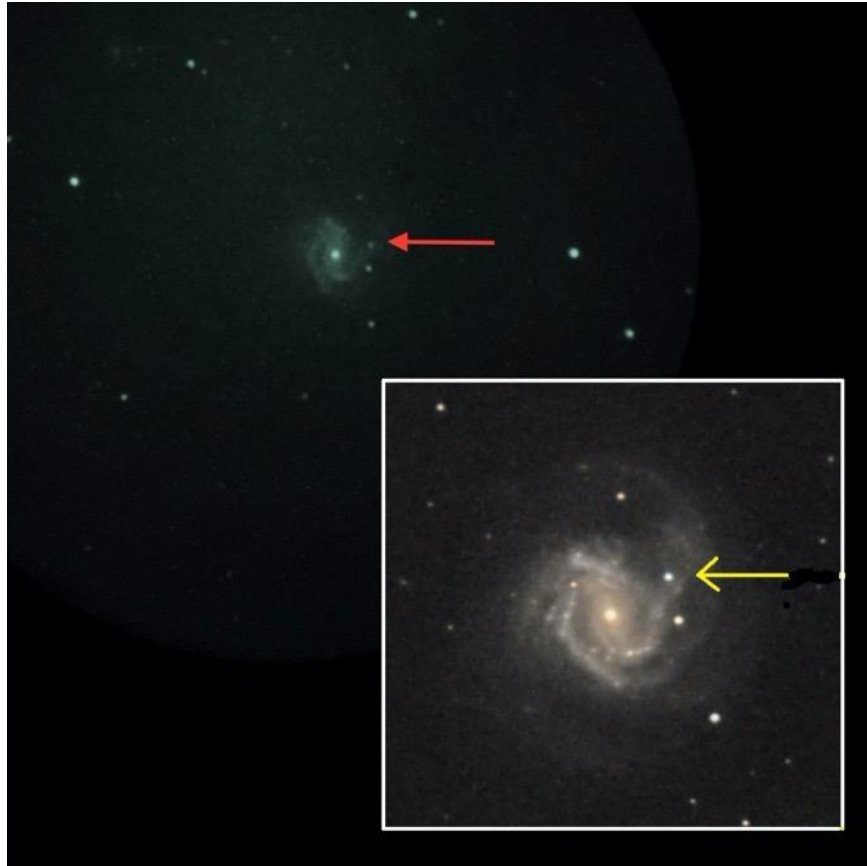

Figure 108. Supernova in the nearby galaxy M-61 on May 6, 2020. Background image taken with a TEC140 apochromatic refractor with Mod3C image intensifier night vision device. **IPhone11** photo 15 second exposure running *Night Cap* app (Credit Mark Johnson). The inset show a larger telescope view and the location of the supernova indicated (Wikipedia).

11.0 Photographing the Sun

Sun photography with smartphones opens up a whole host of issues and potential dangers. I have owned many cameras in my life but NEVER have I even IMAGINED pointing my expensive camera directly at the sun and taking a picture of it. I always used various filters to greatly cut down the light entering the lens. Also, the whole point of photographing the sun is to get beautiful images of sunspots and other features, which you can't do with standard camera telephotos. You need a telescope, and those use specially-designed solar filters to cut through all the glare from this nearby star. Now flash forward a few decades to the modern smartphone camera era and the situation changes enormously. It is common for smartphone photographers to include shots of the sun in the same picture as a foreground subject with the result that the sun disk is a blob of light in the sky. Smartphone camera lenses are only about 3 to 4mm in diameter, compared to the 50mm lens of my favorite Nikon DSLR camera, so these tiny lenses admit about $(3/50)^2 = 1/277$ the amount of light to the internal film or imaging sensor. Is that enough of a decrease to save your smartphone from damage? Judging from the large number of photos you can find using Google,

the full sun disk often finds its way inadvertently into thousands of daytime photographs and selfies, usually at sunrise or sunset.

During the August 2017 total solar eclipse, millions of people used their smartphones in many different ways to capture this rare event. There was quite a lot of discussion online about whether you can damage your smartphone camera by pointing it directly at the sun. The basic argument in favor of it being safe for the camera is that the lenses are generally very small (2 millimeters or so) and do not admit enough light. Also, cameras come equipped with UV filters that cut down on some of the visible light landing on the sensor chip. Finally, they automatically set their exposures for very short times. Nearly every photographer that comments on this issue says it is OK if you do it very briefly such as when you are taking a scenery photo and the sun is in the picture. The argument for it not being safe is that some of the more recent smartphones use larger and faster lenses (f/1.7 to f/2.0) to get better resolution, and that may be a problem. Also, the information and warnings that were published in a NASA article (Odenwald, 2017) for photographing the total solar eclipse are now many years out of date. Entirely new and more sensitive cameras have flooded the market since 2017 with low-light capability, which may make them even more susceptible to damage if you point them, unshielded, at the sun.

Most smartphone cameras have an Auto mode in which they will automatically reduce the exposure speed and increase the f/stop to take the sun photo. This will not harm the camera so long as you do not keep trying to photograph the sun over and over again, thereby building up the camera's exposure time to the bright sun. Do not fuss with the blurry image you get because with a 4mm lens you will simply not see a sharp, clean solar limb. The biggest problem, however, is that you will need to point the camera at the sun, and you will no doubt accidentally glimpse the full-on solar disk and THAT could damage your eyes if you prolong it. The best thing to do is to cover the camera lens with a solar filter. This will eliminate sun blooming and give you a clear image of the solar disk. **DO NOT USE SUNGLASSES!** It is a good idea to set up your smartphone on a tripod or one of those wrap-around mountings so that you can fix the angle of the shot. The sun disk will be small enough that you will want to avoid the inevitable shaking that occurs when holding the camera. If you use the back camera, you will have to point the camera at the sun and look at the screen, which if you do not shade your eyes correctly lets sunlight enter your eye too over the edge of the smartphone case. The front camera over-the-shoulder method may be good enough for most shots but will not be very interesting, compositionally.

If you are using a smartphone, you need to make sure the image is properly focused. Don't count on your auto-focus to do this. You have to do it manually, and this is as simple as tapping the screen and holding your finger to lock the focus. Then slide your finger up or down to darken or lighten the exposure. On iOS camera apps, tapping an object will center a box around it and show a little sun icon. This is the exposure slider. Drag it down until you see details on the image. Android camera apps usually have an exposure setting too, but it might take some hunting around to find it. For example, on the Samsung Galaxy S5, with the camera app running, tap the gear icon to expand the settings options, tap the gear again to enter camera and video settings mode, and tap

again to enter the app's master settings. The Exposure Value control is halfway down the list, and can be slid between +2 (brighter picture) and -2 (dimmer picture).

Without a telescope, binoculars or telephoto, smartphone photographs often show the sun in the FOV, but these are strictly for scenery purposes because the resolution is so poor that the disk of the sun hardly shows against the glare. The smartphone camera with an f/number greater than 2.0 is too slow to damage the sensor, which is hidden behind UV-blocking lenses and auto-adjusts the exposure to hugely limit the light entering the camera.

If you want to image the sun, you really want to at least see the disk of the sun! The only option is to place a filter in front of the smartphone lens to drastically cut back the light and glare. You will end up with a pitch-black sky and a small disk for the sun as big as the full moon. You will probably want to take these pictures during the hours or minutes before totality so that you can capture the moon cutting into the sun disk. At totality, you can take the filter off the lens and take a picture of the eclipse. Once again, the scale of this image will be similar to the full-moon photo you took two weeks before the eclipse. This will give you a sense of scale as you set up your eclipse shots. Many people have posted their attempts at doing this.



Figure 109. This is a typical, digitally-enlarged view of a direct photo through a smartphone. The red halo you see is not the solar corona but simply an artifact of the camera lens blooming, and a consequence of the particular f/stop and exposure used by the automatic setup.

You might be tempted to use the digital zoom feature of your smartphone but this is rather useless. All you will be doing is cropping your original image to a format where it magnifies the image and reveals the individual pixels. It will not alter the actual optical resolution of your shot, which is the factor that determines how much detail you will actually see. For that, you have to physically increase the optical resolution of your camera, which the digital camera industry now calls the optical zoom. For digital cameras like the compact point-and-shoot models or the high-end Nikon D3000 DSLRs, they can provide optical zooms from 2x to 6x by using attached lens systems or by switching to other lenses. For example, a telephoto lens with a focal length of 300 mm will provide 6x optical zoom compared to a standard 50 mm DSLR camera. Some smartphones such as the iPhone 7Plus deliver 2x optical zoom. The Galaxy Zoom smartphones have a variable focal length. For example, the Galaxy S4 Zoom has a 24-240mm f/3.1-6.4 lens. The optical zoom is calculated by dividing the longest focal length value to the shortest one. So, in the case of the Galaxy S4 Zoom, the optical zoom is 10x.

So how big should you expect the sun disk to be in your smartphone image? The diameter of the sun and moon are both about 0.5 degrees. What this means is that for a typical smartphone at its native 1x resolution, its 90 arcsecond resolution will cover the diameter of the sun and moon by $1897/90 = 21$ resolution elements. That is the best you will be able to achieve no matter what 'photoshop' trickery you try to do! The way in which a smartphone's pixels are matched to its

maximum optical resolution is actually complicated by the fact that the pixels in the very small CMOS chip are greatly magnified so that they can be displayed on the screen of the smartphone. Manufacturers talk about ‘retinal resolution’ for their displays but this has little to do with the actual optical resolution of the CMOS sensor! The only way to optically improve the clarity of an image is with the smartphone attached to a telephoto, a pair of binoculars or a telescope. This makes the aperture of the camera lens much larger, and so it decreases the angular scale of the field of view, which is covered by the array pixels.

11.1 Solar Eclipse Photography

Most of the ‘beauty shots’ you see related to solar eclipses will be taken with professional digital cameras on tripods, or shot through a telescope, but the most common photos you probably see will be taken by the millions of smartphones used by ordinary people. Here in Figure 108, for example, is an image taken of the August 2017 total solar eclipse with a smartphone.



Figure 110. August 2017 total solar eclipse from Oregon taken with a **Blackberry** phone at 1/20-sec and ISO 571. (Credit Wikipedia)

You only have about 5 minutes or less to take photos of an eclipse during totality, but don’t forget to take some photos of the surroundings, what people are doing, etc. This will require low light level ‘twilight’ photography on your smartphone, and you may need to download a specific camera app that let you manually adjust exposure speed, etc. Practice taking photos several days before just after sunset during twilight, because the light levels will be similar if you are on the path of totality. You might even visit the exact spot near the time of the eclipse, but several days before, to format your shots and get the right photo composition. The eclipse will happen roughly due-south of your location, so make sure you have a reasonably unobstructed view.

Practice photographing the full moon to get an idea of how large the sun-in-eclipse will appear with your smartphone’s lens, or with a telephoto lens attachment. Moon photography is a challenge because the camera will try to automatically adjust the exposure but most of the view will be the dark sky, so the moon’s disk will be overexposed and show no details. To get around this, most smartphones let you adjust with your finger where the focus and metering spots will be in the field. There are many smartphone apps that have greater flexibility than the one that comes with your camera, and you should consider testing as many of them as you can before the eclipse to find the right one. Several apps exist for both Android smartphones and iPhones, which claim to enhance your device’s picture-taking abilities. One of the best is Adobe

Lightroom. Other decent low-light apps include *Camera+* and *NightCap* available for iPhone users. The more test shots you can take in the days and weeks before the eclipse, the less time you will waste when the eclipse occurs!

One effect that you might try to record if you have an unbroken view of the northwestern horizon is the rapid approach of the lunar shadow before it passes over your location at totality. You need to be in a field somewhere with a view of the ground out to the horizon like on a hill or even a mountain facing west. In the distance you will see the ground darken and then in literally a few seconds the sky near you will turn to twilight as totality begins. You will not need a camera filter to see this effect. Then you can look up and see the sun in full eclipse.

Rather than trying to photograph the eclipse itself, concentrate on what people around you are doing, but perhaps with the eclipsing sun in the field of view too. Take a time-lapse photo series of the scenery as the light dims with the smartphone secured on a tripod or other mounting so that you can watch the eclipse while your camera photographs the scenery. You might even want to shoot some video in the minutes before, during and after to record people's reactions and the inevitable oohs and aahs!

Digital zoom will not work to create a magnified, clear image. Instead, go buy a \$20-\$40 telephoto lens attachment that will give you a total of digital zoom x optical zoom = 12x to 18x. For moon photography in the days and weeks before the eclipse, this will let you see a large moon disk, resolve mare features, and perhaps see a few large craters. At this magnification, the total solar eclipse will also look much nicer because you will be able to start to see details in the shape of the corona! Consider using the delay timer set at 5 seconds so that once you press the exposure button, the camera waits 5 seconds before taking the shot. That gives your camera/tripod/clamp system plenty of time to settle down and produce vibration-free images.

Your most difficult challenge will be in managing your expectations! Smartphones were never designed to do sun and moon photography. The standard lenses are very small, and provide hardly any resolution at all for even the largest objects in the sky like the sun and moon. These objects are only 1/2-degree in diameter, and for a typical megapixel smartphone, their disks will only cover a few dozen pixels in your final image.



Figure 111. Photo of the young crescent moon with earthshine and the bright planet Venus using a Samsung **Galaxy S4** phone. The inset shows a magnified moon revealing the pixel digitization. (Credit Chris Vaughan)

By itself, Figure 111 is a lovely suburban composition, but let's say you are greedy and want to do some technical astronomy with this image. If you enlarge this image around the moon you get the result shown in the inset for Figure 111. You can tell it is the moon, but there is no detail to be seen in the prominent lunar mare, which are easy to see with the naked eye. This image would be very similar to a partial solar eclipse seen through a filter (with the sky black of course!). Nevertheless, the original wide-field photo with the eclipsed sun taking the place of the moon would still be a stunning image to have because you can also capture the scenery and people watching it happen!

If you want to image the sun, you really want to at least see the disk of the sun! The only option is to place a filter in front of the smartphone lens to drastically cut back the light and glare. You will end up with a pitch-black sky and a small disk for the sun as big as the full moon. You will probably want to take these pictures during the hours or minutes before totality so that you can capture the moon cutting into the sun disk. At totality, you can take the filter off the lens and take a picture of the eclipse to reveal the faint corona. Once again, the scale of this image will be similar to the full-moon photo you took two weeks before the eclipse. This will give you a sense of scale and optimum focus as you set up your eclipse shots.



Figure 112. An example of how a proper solar filter from official solar eclipse viewing glasses can be adapted as a solar filter for a smartphone. This was taken using an old pair of NASA-approved solar viewing glasses previously used to photograph the 2004 Transit of Venus.

Figure 113. Total solar eclipse of August 21, 2017 shot with no telescope and a hand-held, **Samsung Note 5** phone with auto settings. No filter was used since the solar surface is not viewable during totality. This image gives you an idea of how large the sun will appear in a typical smartphone picture with no additional camera magnification. The general shape of the corona is clearly visible. (Credit Mir Oslov)





Figure 115. (Left) August 21, 2017 total solar eclipse taken with an **iPhone 6** and a 30mm phone telephoto lens. No filter was used so that the faint corona could be seen. (Credit Fernando Labra). (Right) Digitally-enlarged shot with a **Samsung Galaxy S7** handheld and no telescope or telephoto with native camera at 1/50-seconds and ISO 50. (Credit Joe Adlhoch)



Figure 116. Total solar eclipse of August 21, 2017 taken through an Orion 127-mm Maksutov with an **LG G5** phone, 1/15-second at ISO 64. (Credit Christian Harris).

Figure 114. The total solar eclipse of August 21, 2017 with a Celestron 70mm Travel Scope and an **iPhone 6s**. Single 1/30-second exposure at ISO 64 using *NightCap* for capture, with no processing or filters. (Credit Christopher Jones)





Figure 117. Photo montage of the August 21, 2017 total solar eclipse. Taken with an **iPhone 7-plus**. (Credit Michael Murphy)

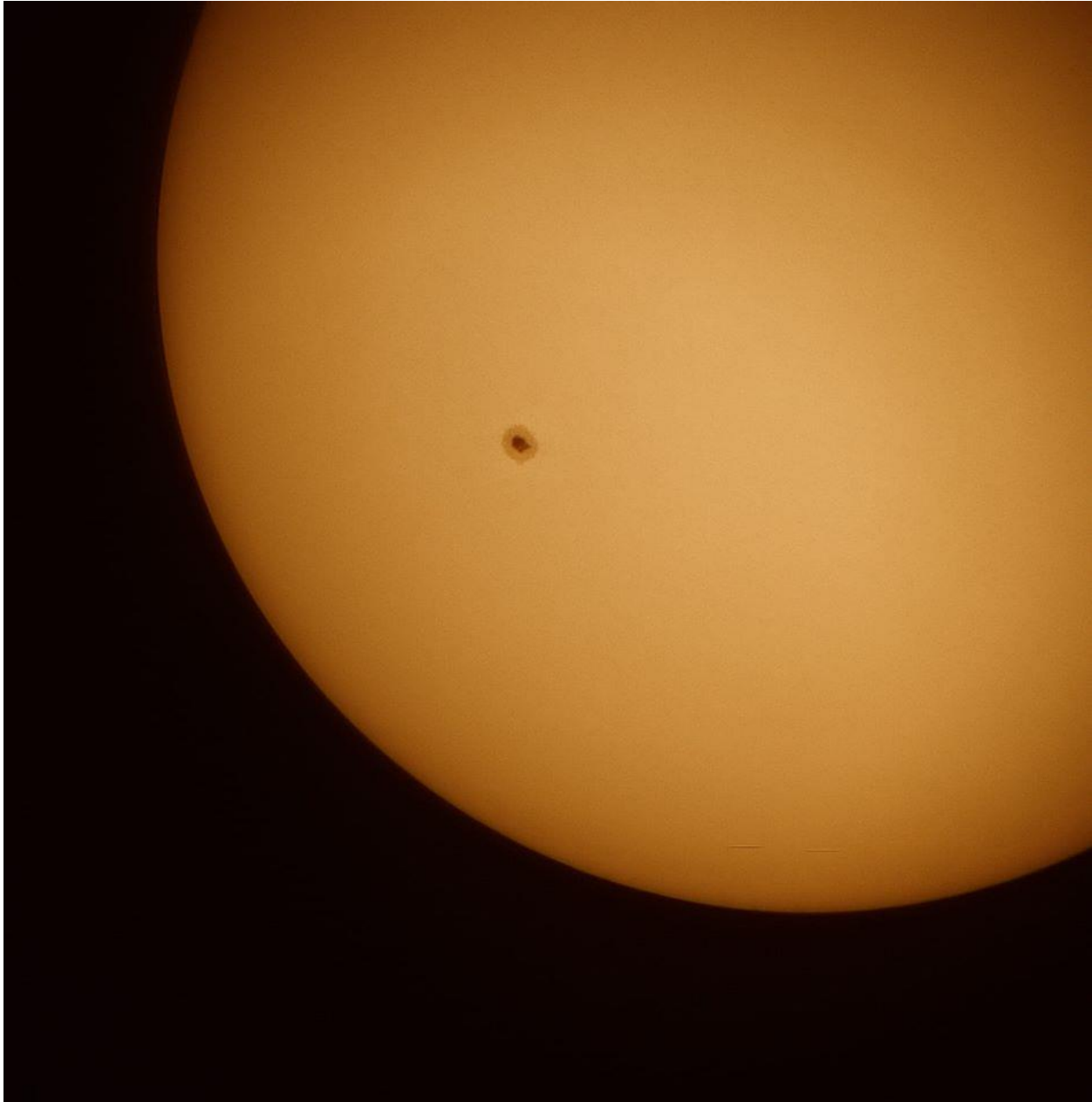

Figure 118. Sunspot May 15, 2019 taken with a Takahashi FS-60, Baader Solar Filter, Explore Scientific 6.7mm eyepiece and a **Xiaomi Pocophone F1**. Produced from 300 RAW image files, each shot at 1/2000 sec at ISO 100. Processed with PIPP, *Autostakkert*, *Registax* and Photoshop CC. (Credit Michael Seeboerger-Weichselbaum)

11.2 Lunar eclipses

Lunar eclipses are not as demanding as solar eclipses to photograph because, while solar eclipses are only observable during totality along a very narrow, 100-km-wide path, total lunar eclipses can be seen across thousands of kilometers. The best lunar eclipse photos are obtained with some

telescopic assistance. The choice is usually between a low-magnification view so that subtle color changes are more easily seen, or close-in shots where large craters and the mare can be studied.



Figure 119. Lunar eclipse sequence on January 31, 2018 taken through a 6-inch *SkyWatcher* reflector with a 25mm eyepiece. The **Samsung Galaxy S8** was set at $\frac{1}{4}$ -sec and ISO 1250 for the darker eclipse shots, and $\frac{1}{536}$ -sec and ISO 40 for the brighter shots. (Credit Nerida Langcake)



Figure 120. (above) Lunar eclipse (Credit Justine Claire Jones)

Figure 121. (right) Lunar eclipse with an Orion StarSeeker 150-mm Maksutov-Cassegrain telescope, a 25mm Super Plössel eyepiece. **LG G7 ThinQ** phone set at ISO 200. 12, 4-second images stacked in AS3. Final image edited in Adobe *Photoshop*. (Credit Christian Harris)



11.3 Extra-solar Photography

There are many other phenomena involving the sun that are definitely worth photographing without a telescope. During total solar eclipses, there are many phenomena you can attempt to capture. One of these is the pinhole-effect caused by the partially eclipsed sunlight passing through cracks between the leaves on a tree. When projected on the ground or the side of a house, hundreds of fleeting solar crescents can be seen against the shadow of the tree. Shadow bands are also visible

but are very illusive to capture photographically. They only appear just before totality when the solar disk is a very thin crescent. When it shines through the clouds on Earth it causes faint bands of darkness to travel rapidly across the ground. You can attempt to see these using a white sheet of paper or poster board. You might even try to use your phone's video feature to capture them, but you may have to set your camera manually to increase its ISO and use exposure speeds of 1 second or less (60 frames-per-second) so as not to smear them out.



Figure 122. Sun crescents through the leaves at about 90% totality on August 21, 2017 from Decatur, Alabama with an **iPhone SE** using Auto settings. (Credit Loren Ball)

Figure 123. Eclipse crescents through leaves on a tree during the August 21, 2017 total solar eclipse. Taken with a **Samsung Galaxy S8+** on Auto mode. (Credit Tim Dillon)





Figure 124. A beautiful solar halo near Slave Lake, Alberta. February 16, 2019 taken in the 'Pro' mode of the native camera on a **Samsung Galaxy S9** phone. (Credit Billy Heather)

Under some atmospheric conditions, sunlight reflecting off ice crystals in the upper atmosphere can produce halos of light encircling the sun (and moon). Rather than random splotches of light, the geometry of these ice crystals creates multiple reflections of the sun, called sundogs, located 22 degrees to the left and right of the sun. Also, very complex refractive phenomena called parhelia can also be observed. Smartphones have such large fields-of-view and sensitivity that they make the perfect cameras to capture these effects, which are very fleeting and unpredictable.

And then of course, no one can resist trying to capture another solar phenomenon called the rainbow. The challenge here is to also find situations in which a double rainbow appears. In these photographs, the framing and composition of the photo are nearly as important as the rainbow itself, so try to capture the event with the best possible foreground and background scenery!

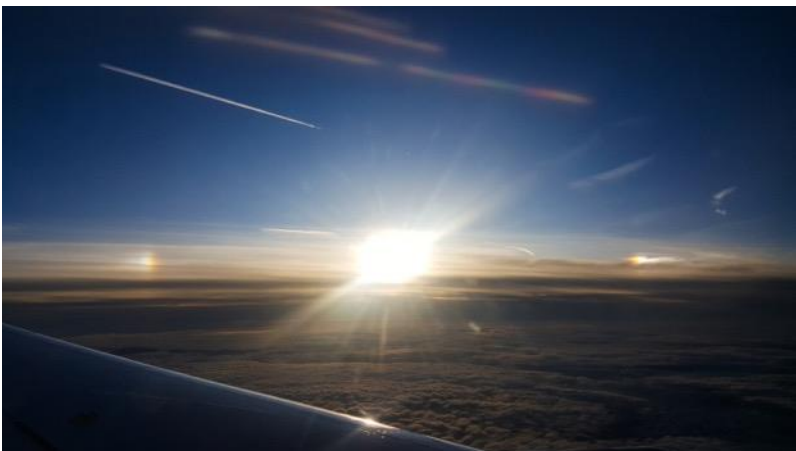

Figure 125. Sundogs seen from a jet with a **Samsung Galaxy S6** at ISO 50 and a 1/2528-second exposure. Note the rainbow effect. (Credit Rocco Lico)



Figure 126. Rainbow photographed in auto mode with a **Huawei P30 Pro**. The 16mm lens is wide enough to capture a double rainbow and an attractive foreground composition. (Credit Tony Karp)

11.4 Solar surface photography with telescopic imaging.

Several inexpensive smartphone adapters let you mount your device on a telescope or binocular such as the *iOptron Universal Smartphone Eyepiece Adapter*, the *Orion SteadyPix Universal Smartphone Adapter*, and the *TeleVue FoneMate*. These cost about \$40.00. By and large, the best images of the sun, whether during an eclipse or not, will be produced using a telescope. For this, as for previous telescopic photos of the sun, you will need a proper solar filter and smartphone-to-telescope adaptor, but you will also need something to photograph. This is limited to three kinds

of solar phenomena when the sun is not in eclipse: sun spots, prominences and granulation. At the time of this writing in 2020, the sun was at sunspot minimum so it showed very few if any sunspots.

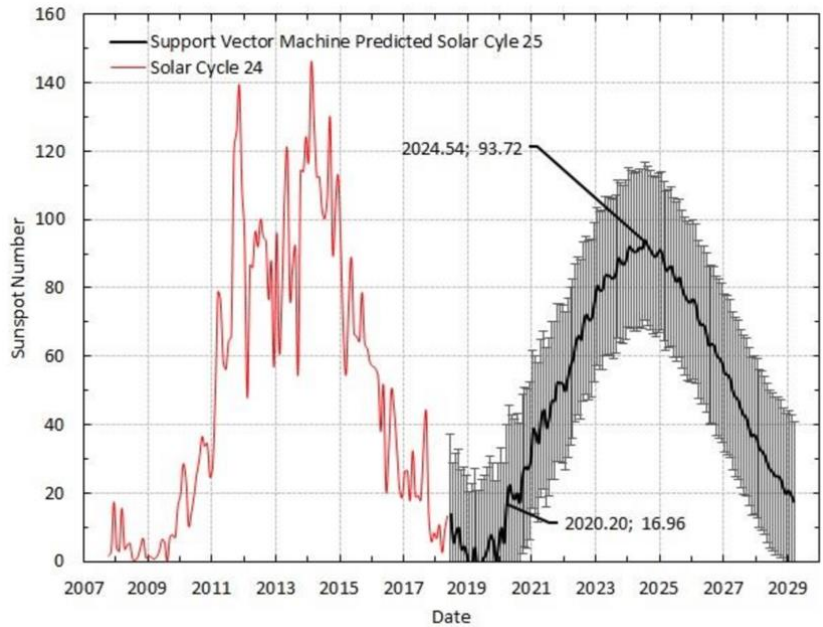

Figure 127. An example of a prediction for the next sunspot cycle (Number 25) showing the basic details of the minima and the peak along with estimated dates. (Dani and Sulistiani, 2019)

The solar surface is not a blank slate but thanks to solar granulation, it has a mottled surface that gives interesting texture to the image. To see this granulation, you need a telescope of at least 6-inches in aperture to resolve these arc-second features, but more importantly because granules change in shape very rapidly you need not just any kind of solar filter, but one that only passes the light from hydrogen at a wavelength of 656.28 nm, called an H-alpha filter.

These are available through companies such as Coronado PST for \$700 (Personal Solar Telescope) or DayStar (e.g. the ST 60/930 SolarScout SS60-ds H-Alpha OTA for \$1,200). For details on this level of solar photography see King (2015).

11.4.1 Broadband Filters

These filters block 99.999% of the sunlight. The bandpass of these filters typically blocks the UV and infrared spectrum and passes the rest of the visible light spectrum from wavelengths of about 400 (blue) to 700 nm (red). The main purpose of these filters is to greatly reduce the amount of light across the visible spectrum that enters your telescope or camera.

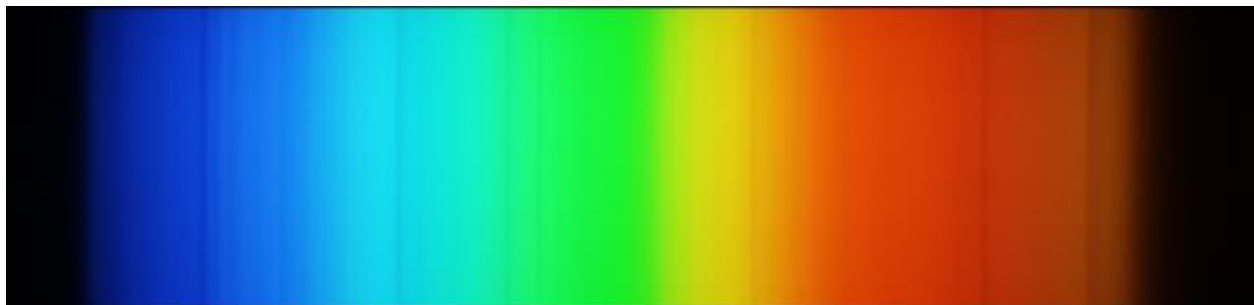

Figure 128. Spectral response of a typical broad-band solar filter (Credit Christian Buil)

There are three common types: metal-on-glass (most durable to scratching), aluminized polyester (Mylar) film, and black polymer. The resulting color of the sun through the eyepiece can be white, yellow, orange or bluish, so choose the filter for the color you are comfortable with.

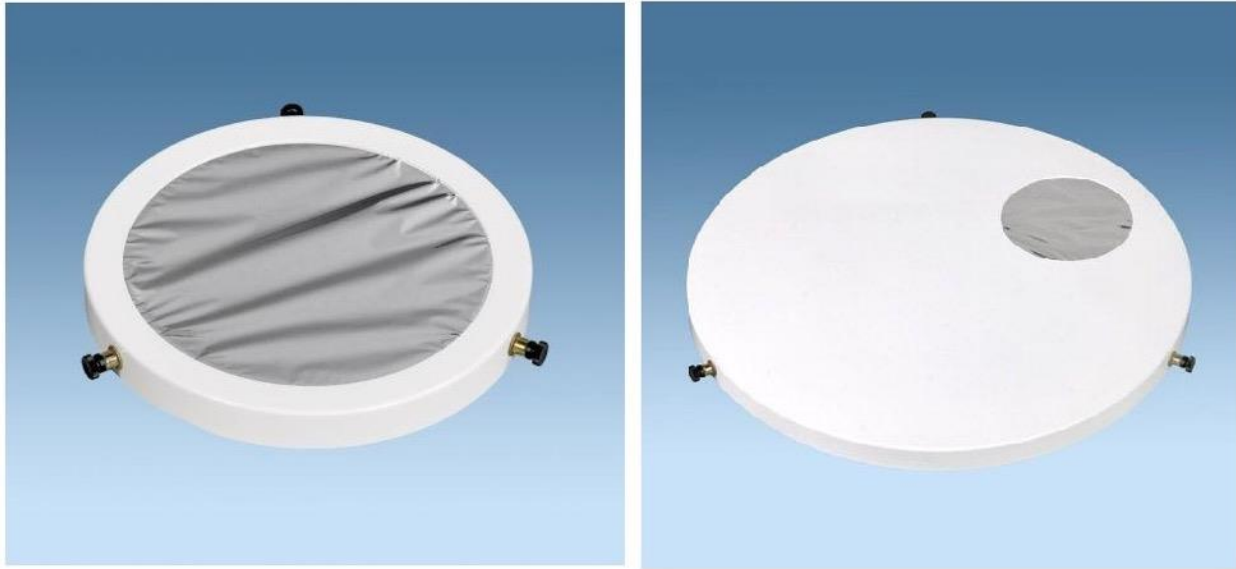

Figure 129. Comparison of a full-aperture (left) and an off-axis (right) broadband filter. (Credit AstroZap)

Off-axis filters have a cover over the full aperture of the telescope, but only admit light through the filter from a smaller aperture located off the main axis of the telescope barrel. Full-aperture filters are as their name implies allow sunlight to enter the telescope across its full aperture diameter. The advantage of the reduced aperture off-axis filter is that the optical diameter of the telescope is reduced so its lower resolution is less able to detect atmospheric turbulence that distorts and blurs solar surface details.

Thousand Oaks Optical – Full-aperture film filters can be ordered for any aperture OD from 2-inches to 17.7-inches.

Celestron EclipSmart - Off-axis filter and full-aperture filters for a variety of binoculars and small telescopes up to 200mm (8-inches) aperture in the Celestron product line.

Orion Full-Aperture filters – Optical glass, full-aperture solar filters.

Seymore Solar Filter - They come in both off-axis and full aperture models.

Baader continuum filter is a broad-band filter with a peak wavelength of 540 nm and a bandwidth of 10 nm. It screws into your eyepiece so that the full light and heat energy of the sun is delivered to the base of the eyepiece. This is incredibly dangerous so it must be used in conjunction with a full-aperture or off-axis broad-band filter otherwise eye or equipment damage will occur.

The figures 128-131 show typical telescopic views of the solar disk using common broadband filters. These were taken in 2019 during a period of low solar activity called sunspot minimum when few or no sunspots can be found. Figure 129 shows one small sunspot (called an active region) and also the slight change in surface brightness toward the limb of the sun. This 'limb darkening' effect is due to the fact that you are not looking as deeply into the solar surface towards the edge of the sun and so there is less light-producing plasma in the photosphere above the depth that you are seeing.

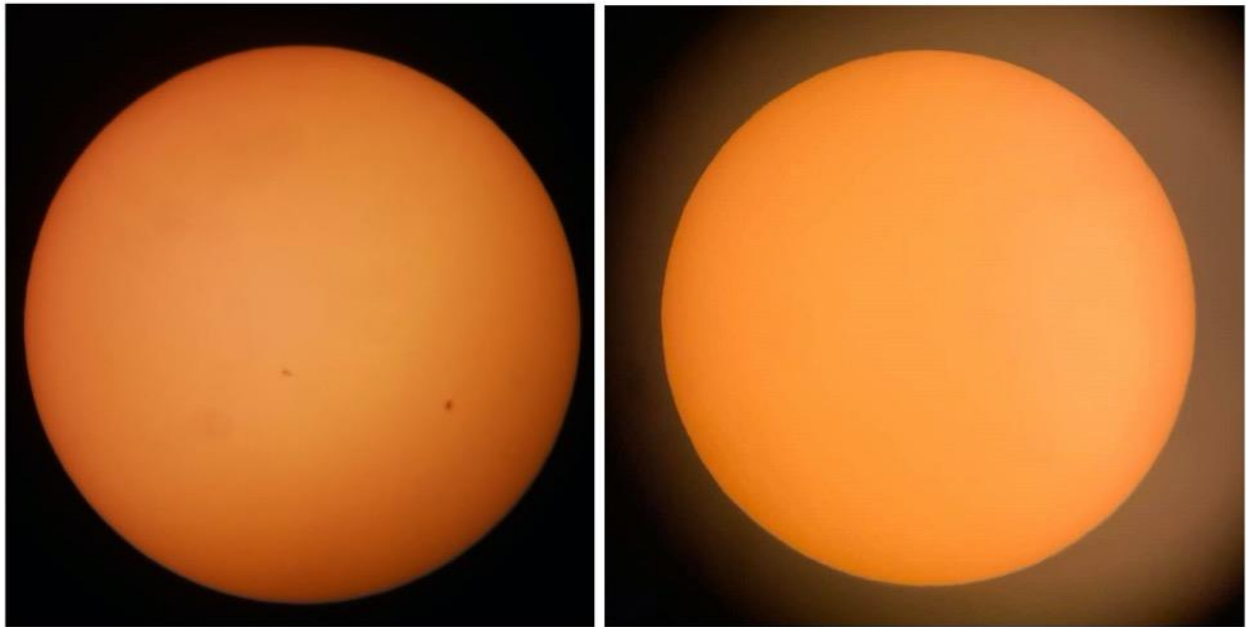

Figure 130. (Left) The Sun on November 4, 2019 featuring the two sunspots AR 2740 (towards the middle) and AR 2741(lower right). Taken through a Skywatcher Virtuoso 90mm (3.5-inch) Maksutov with full aperture Seymour Solar filter and a Meade 20mm eyepiece. Photo with a Samsung **Galaxy S9** in Pro Mode. ISO 50 Exp 1/45 sec. Edited with *Aviary* and *Phonto* (Credit Julie Straayer) (Right) a spot-free sun taken through a 4-inch refractor NexYZ **iPhone 11** with a Thousand Oaks solar filter. (Credit Jeff Charles)



Figure 131. Sunspot in April 2019 taken through a Takahashi 60mm telescope with a Baader continuum filter, and photographed with a **Xiaomi Pocophone F1** using *DeepSkyCamera* (Credit Michael Seeboerger-Weichselbaum)

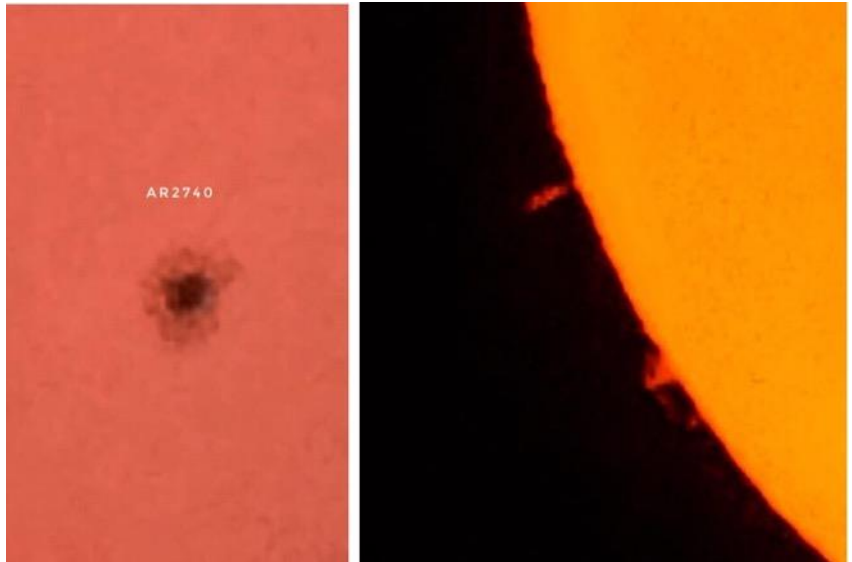

Figure 132. Left) Sunspot AR2740. Right) Solar prominences on September 23, 2018. Taken with a Coronado Personal Solar Telescope and an **iPhone 5s**. (Credit Chris Woodcock)

Some astrophotographers use a Baader continuum filter and are able to see granulation when used with a full-aperture broadband filter. In one combination not using a smartphone shown in Figure 128, the filter is attached to a video camera. The video stream is then saved, converted

into individual frames using software such as PIPP, and then stacked and processed to get the clearest final image.



Figure 133. Sun photographed through a white light solar filter and a Baader continuum filter with a 5-inch refractor. Each of the 400 photos were shot at 1/125-sec and the best 200 were stacked and combined. (Credit David Cortner).

Other astrophotographers use common polarizing filters from sunglasses to help bring out these faint details. The key to seeing granulation involves getting the proper focus, and for this you need a sunspot in the field.

11.4.2 Narrow-band Filters

What counts in these filters is the narrowness of the H-alpha filter bandpass because this controls how much solar white light is entering the

image, which will wash out the details in the images. Typical inexpensive filters have about a 1-Angstrom (0.1 nm) bandpass. For the best and most dramatic images you need band passes of 0.3-Angstroms or smaller which become progressively more expensive. For example, the *Coronado Solar Max 60 H-alpha* filter used in Figure 130 has a bandpass of 0.7-Angstroms and with it you begin to see a variety of surface details at high resolution.

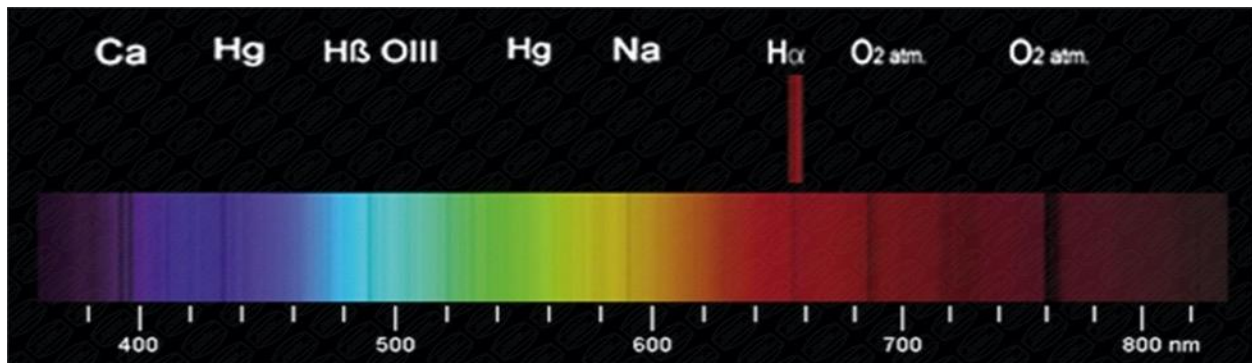

Figure 134. Baader ultra-narrow band H-alpha filter (3.5nm bandpass) compared to a broad-band filter. (Credit David Hinds LTD)



Figure 135. The Sun. This is a composite of two images, one taken at 1/250 second at ISO 100 to capture the surface details, and the second taken at 1/40 second at ISO 100 to capture the prominences. Both were taken with a **Canon 450D** through an 80-mm telescope with a Coronado Solar Max 60 H-alpha filter. (Credit Jim/Deb Bonser)

Aside from the (expensive) filters, you also need to take many short-exposure images and use the stacking techniques mentioned earlier to eliminate bad or blurry images. Most astrophotographers who can invest in expensive narrow-band filters also tend to have DSLR cameras and use these rather than smartphones to do their solar photography. Consequently, there are not many examples of solar granulation photographed with smartphone cameras.

12.0 Meteors and Comets

This is another subject that takes advantage of the wide-field camera format used in constellation photography, and the technique is exactly the same. You can also take star trail photos and capture meteors that way if you don't mind the trailed star images going in circular arcs. On any given night you will see a few meteors, but the best times are during one of the annual meteor showers shown in Table 3. The 'ZHR' or Zenith Hourly Rate gives you some idea of how long you will wait to see a meteor. At levels of 60 or higher, you see about one meteor every minute.

Table 3 A list of the most active meteor showers

Shower	Dates	Maximum	ZHR
Quadrantids	January 1 - 5	January 3	120
April Lyrids	April 16 - 25	April 22	15
E-Aquarids	April 19 - May 12	May 5	60
Arietids	May 29 - June 19	June 7	60
Zeta Perseids	May 20 - July 7	June 9	40
Delta Aquarids	July 12 - August 19	July 28	20
Perseids	July 17 - August 24	August 12	100
Orionids	October 2 - November 11	October 21	20
Leonids	November 14 - 21	November 17	20
Geminids	December 7 - 17	December 14	110
Ursids	December 17 - 26	December 22	>12

An app called *PhotoPills* (\$9.99, iOS, Android) takes the guesswork out of planning and setting up your photos, but it also provides information on solar and lunar eclipse viewing, getting the right position for the Milky Way in the sky from your location, and of course sunrise and sunset. It provides an AR interface much like the *Planets* (iOS) app does.

Unless you are satisfied with one meteor captured per photograph, it is best to take a series of pictures of individual events and then composite them together. The *NightCap* app has a Meteor Mode that automatically takes photos (about 720 per hour with a 5 second exposure time), then scans them and only saves photos it thinks might contain a meteor. During capturing you'll see "Capturing... (4/20)" at the top of the screen. The two numbers are the number of photos saved, and the total number taken (in this case 20 photos taken, 4 saved to the camera roll).



Figure 136. (Left) Meteors with a **Huawei P20** (Right) Two comets through 15x70 binoculars and a **Huawei P20 Pro** smartphone with 5 second exposures. (Credit Donald Nool)

Photographing comets is much more like photographing deep sky objects because the majority of comets during any given year will appear as fuzzy and faint blobs resembling galaxies and so the same kinds of stacking and calibration techniques apply. Although dozens of comets are discovered every year, only a small number are bright enough to be seen with the naked eye or have the classical comet-tails we expect to see. The best place to get an update on what comets are available for viewing are services such as In-The-Sky (<https://in-the-sky.org/data/comets.php>) or Comet Chasing Sky Hound (<https://cometchasing.skyhound.com/>), which will tell you what the daily opportunities are, and what you should expect to see.



Figure 138. Comet NEOWISE (C/2020 F3) photographed July 13, 2020 from Bushmills, Northern Ireland with a **Samsung S20 ultra** on a tripod, ISO 800 with a 15 second exposure (Credit Andrew Lomax)



Figure 137. Comet NEOWISE July 9, 2020 photographed using a Celestron CPC 1100 telescope through a 40mm Plössel eyepiece with an **iPhone 11Pro**, (Left) A single, ISO 250, and a 10-second exposure. (Right) 35 frames extracted from a 20-second video stacked in *Registax* to show more detail (Credit Chris Barkley)



Figure 139. Comet NEOWISE with a Skywatcher 200-mm f/5 Newtonian telescope, and a **Huawei P20 Pro** with a 10-sec exposure at ISO 650. (Credit Robert Grögler)

13.0 Photographing Artificial Satellites

Given how cluttered earth's orbital region is from 140km to 1,500km with over 100,000 pieces of space junk, it is almost impossible not to photograph spacecraft during the 2-hours after sunset or 2-hours before sunrise. It is really pretty simple to do because the streaks resemble slow meteors. Most modern smartphones that produce good constellation photos will also capture satellites which can be as bright as Venus (e.g. the International Space Station) or as faint as the faintest stars you can see (+6m for the fainter *StarLink* satellites). You need a camera tripod, and because the transits take only a few minutes to cross the sky, exposures longer than 10 seconds will show significant streaks. The best planning for your campaign is to visit the Heavens-Above.com website and use their satellite transit calculator. Once you set the date and your location, it will tell you which satellites will transit from your location and give you a sky map to show where to look, such as the one shown in Figure 138.

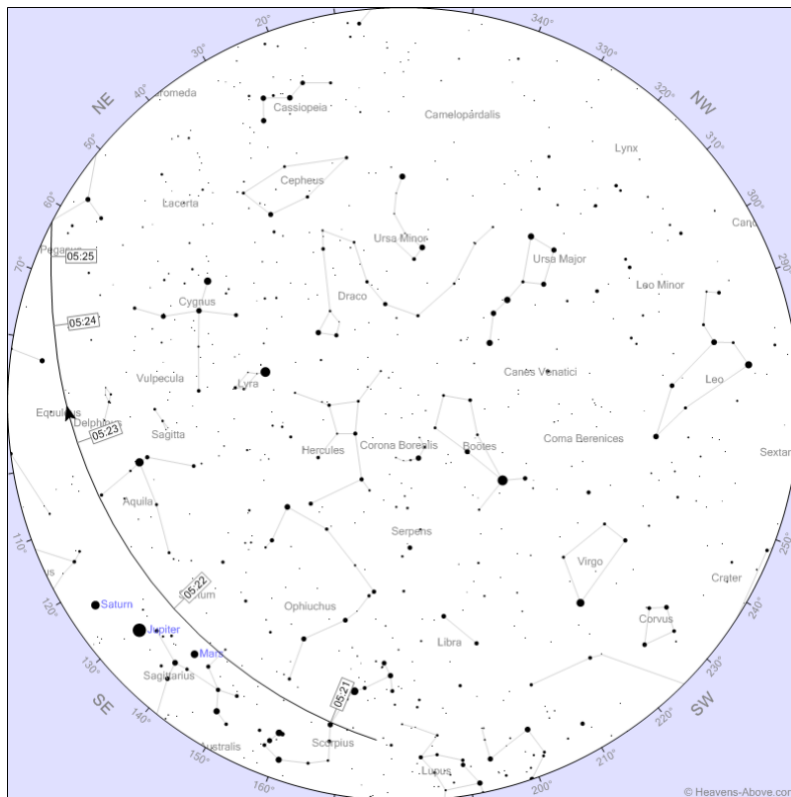

Figure 140. Heavens-Above sky chart for the transit of *Starlink* 1105 on February 29, 2020 from Kensington, Maryland. (Credit Heavens-Above)

The table of transits for that day also give the maximum brightness in stellar magnitudes. Anything brighter than +6.0m will be seen by a smartphone camera at a setting of 10 seconds and ISO 800. These images can be prolonged to several minutes using third-party apps to get one continuous streak crossing the sky. You can also use stacking techniques or the phone's video camera.

It is worth noting that these satellites are brighter near the zenith when they are still in full sunlight and fade quickly as they approach the eastern horizon. Also, they will appear brighter to the naked eye than in these photographs because the light is

more concentrated on the retina than it is when smeared out over dozens of pixels. You may want to experiment with increasing the ISO and decreasing the exposure times to improve contrast.

13.1 The International Space Station

Any careful observer of the night sky after sunset or before sunrise has seen satellites and even the International Space Station (ISS) scooting along the sky among the stars. The ISS is easy to spot because of its huge solar panels that make this object very bright in the sky.



Figure 141. The ISS in twilight skies with a **Canon EOS 400D** 75mm focal open F/5: 15 seconds, 400 ISO. (Credit Jean-Marie Andre Delaporte)

Some astrophotographers are not content to just photograph the ISS sky streak through the star fields. Instead, they want to actually image the details on the ISS! One very popular ‘game’ is to try to photograph the ISS transiting the sun or the moon. For this you need an accurate transit ephemeris such as the one available at <https://transit-finder.com/>, and then carefully plan your shot, which could involve your actually driving to a distant location so that the parallax angle is optimum for it to pass across a 0.5° disk in the sky from your location. It is noteworthy that if you travel as little as 3 km, the parallax shift for a satellite in an orbit of 500km above earth’s surface is $2\arctan(3/500) = 0.7^\circ$, so you will miss your transit opportunity if you are in the wrong place! Also, the satellite in this orbit will travel the diameter of the moon in a fraction of a second so you have no time to fumble around! This is not an impossible task given the resolution of modern amateur telescopes.

At an orbital distance of about 400 km the angular scale at the orbit of the ISS is found from $\theta = 206265 L/H$ where L is the scale in meters, H is the orbit altitude height in meters and θ is the angle in arcseconds. So, at H=400 kilometers we have $\theta = 0.5 L$. A 109x73-meter ISS would subtend an angle of 55x36 arcseconds. This is comparable to the visual acuity of the human eye (about 25 arcseconds) under the most favorable conditions, but could be easily resolved by an eagle (6 arcseconds), although they have poor night vision.

The speed of the ISS in its 90-minute orbit is about 7.4 km/sec. At an altitude of 400 km, it travels 7.4 km in one second or in angle measure 3437 $(7.4/400) = 64$ arcminutes, so its angular speed would be 64 arcminutes/sec. The diameter of the full moon is only 30 arcminutes, so the ISS travels two lunar diameters in the sky every second! If you use an eyepiece such that the moon completely fills the FOV, the ISS will travel across the eyepiece FOV in about 1/2 second. That is not a lot of time even at this low magnification, to ready your shot and tap the button, even not allowing for the few seconds it takes for the camera to stop shaking after you tap it! How do astrophotographers get around this problem? Amazingly, smartphones provide exactly the technology to make this photography happen. Here's how you do it.

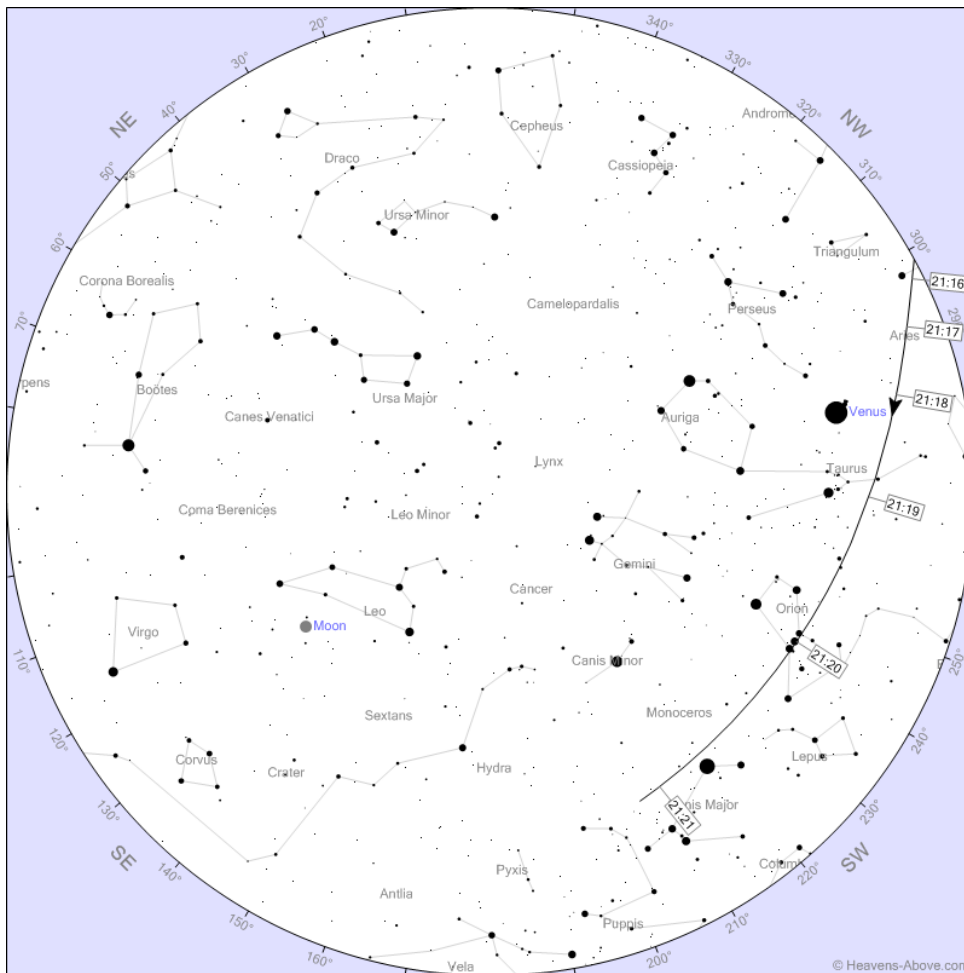

Figure 142. The track of the ISS from Kensington, Maryland for April 5, 2020.

First you need to check up on when the ISS will be passing over your location. You can use Heavens-Above.com to do this, which provides handy sky charts of the ISS path for that time as the sample shows in Figure 140.

Next, pick a time when you want to intercept the ISS. For example, at 21:20 EST on April 5, 2020 as viewed from Kensington, Maryland the ISS will be passing through the Belt of Orion, which is a very easy target to identify in the sky. The next step requires some preparation. You need to become familiar with taking video with your native camera (or your favorite app!). You will need to take a high-speed burst at about 60 frames per second (fps) and see what kinds of individual frame settings you need. The ISS is so bright that starting at 1/2000-sec would be a good start to minimize motion blurring. Once you have found the right focus and settings, point your telescope + phone towards your target area on the path of the ISS. Starting about one minute before you expect it to appear in the eyepiece, tap the ‘video’ button and start taking images.

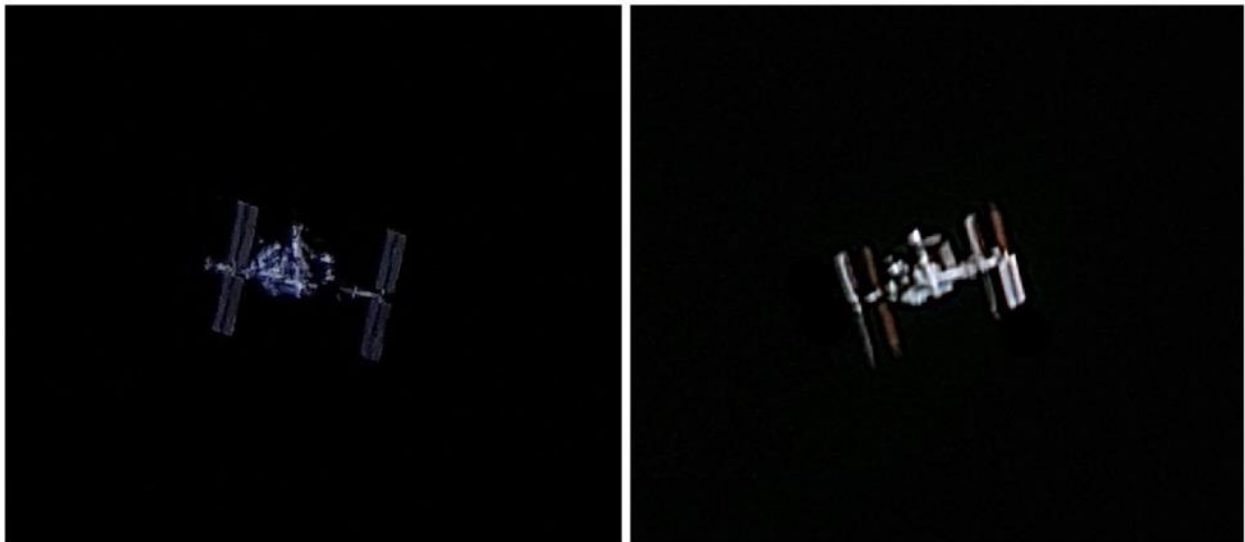

Figure 143. (Left) The ISS with a **Samsung Galaxy S9** through a 10-inch Dobsonian telescope with a frame rate of 60 fps with each exposure set at a shutter speed of 1/2000 seconds and ISO 100. (Credit Matthijs Burgmeijer); (Right) The ISS through a 12-inch telescope with a 9mm eyepiece and a 2.5x Barlow lens, and photographed with an **LG V20** phone on manual focus and pre-focused on the moon. (Credit Tom Campbell)

Let this continue until about one minute after it is predicted to have passed through the eyepiece FOV and stop the video stream. The video can then be exported to your laptop and processed into individual frames using any of a variety of video editing programs such as *Cyberlink Power Director* or the *Planetary Imaging Pre-Processor (PIPP)*. PIPP is a Windows application that extracts the best frames from an AVI file to be used for further processing. It is used by planetary astrophotographers who take video streams of planets through their eyepieces and toss out the ones that show defects or signs of atmospheric turbulence.



Figure 144. The ISS shot through a 6-inch Dobsonian telescope with no tracking. An **iPhone 7** was used and attached to a 15mm eyepiece with a 2x Barlow lens. The ISS was manually tracked through the finder scope. The *ProCam 4k* video app was used and set for a shutter speed of 1/1000-seconds at a low ISO value to keep the ISS from over-exposing. Individual frames were extracted using *SnapStill* or *StillShot* apps and then cropped and enhanced using the iOS *Photos* app. (Credit Keith Stanley)

before they duck into earth's shadow cone in the post-twilight sky. Low-earth-orbit (LEO) satellites can be seen as sunlight reflects off their surfaces up to 2 hours after sunset or 2 hours before sunrise.

For astronomers this is an annoyance because these streaks can interfere with certain kinds of photographic studies that begin after astronomical twilight ends 45 minutes after sunset, or ends 45 minutes before sunrise. Those precious hours can mean a lot for detecting near-earth asteroids or doing deep surveys of astronomical objects that require entire nights of observing. But when there were only a few of these satellites to worry about, life was simple and astronomers developed 'countermeasures' to make sure these bright satellites did not ruin sensitive photographs. You simply looked up the ephemeris of the satellites for the night of your observation, and made sure that you started your program on some other object in your list that wasn't along the satellite's path across the sky during its flyover time. When there were only a small number of these LEO satellites in orbit up to 1000 miles from Earth's surface, this interference was manageable by various scheduling and software fixes. Now this has dramatically changed.

Since 2019, Space-X has begun the aggressive launching of up to 60 satellites every week to populate a dense satellite constellation called *Starlink*, which after a few years will have 10,000 or so of these satellites in LEO. The FCC approved a request in April 2019, allowing Space-X to place nearly 12,000 into LEO. The first large deployment of the constellation occurred on May 24,

Hopefully, among these hundreds of video frames you will see the ISS. Now for future opportunities you can adjust the fps and camera settings to improve the focus and clarity of the ISS image. Also, the bigger the telescope you use, the more detail you will see up to the seeing limit of the atmosphere (about one arcsecond or 2-meters at the ISS).

13.2 Starlink Satellites

Although the ISS with its huge solar panels turns this streak of light into nearly a shooting star in brilliance, virtually all other satellites are relatively hard to see and appear as faint stars gliding across the sky. You only get a handful of seconds to see them

2019 when 60 satellites were launched. Other companies are following suit and plan to launch their own space-Internet, mega-constellations. By the end of June 2019, forty-five *Starlink* satellites had reached their final orbital altitude of 550 km (340 mi), five were still raising their orbits, and another five were undergoing systems checks before they raise their orbits. This means the satellites will start out very bright at their lower initial orbit, then fade a bit as they are moved to their final, higher orbits. As of June 13, 2020, SpaceX has launched 538 *Starlink* satellites. They plan to launch 60 more per Falcon 9 flight, with launches as often as every two weeks in 2020.

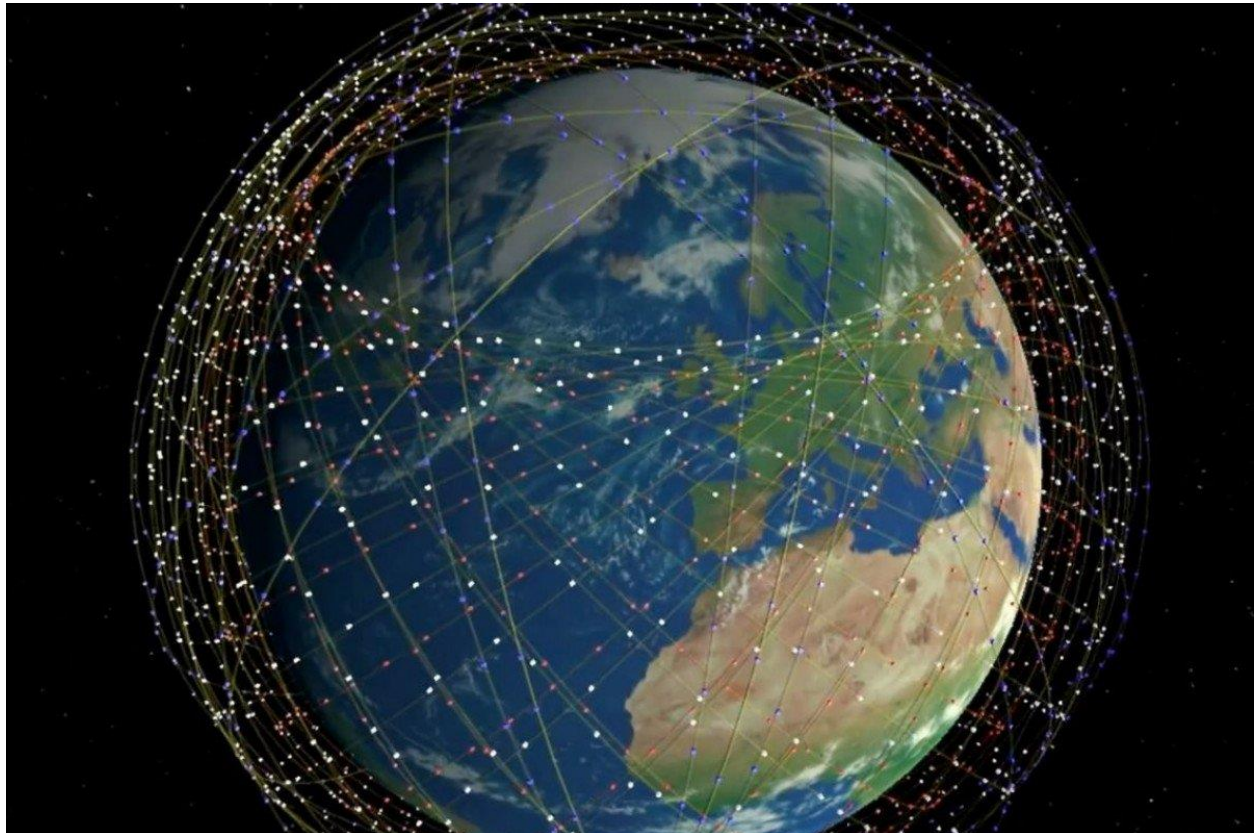

Figure 145. The planned constellation of Starlink satellites in Low Earth Orbit. (Credit WebbyFeed.com)

Astronomers are not happy with any of this, and you can imagine why.

Calculations by astronomers for how these reflective satellites will affect early evening and early morning observing programs are not optimistic. Their brightness in both optical and radio wavelengths is expected to severely impact scientific observations. Because the *Starlink* satellites can autonomously change their orbits, observations cannot be scheduled to avoid them. The International Astronomical Union and National Radio Astronomy Observatory have even gone so far as to release official statements on the matter. SpaceX originally claimed that the satellites will have minimal impact, but the first 60 *Starlink* satellites now provide hard data, and it is not at all good. In later statements on Twitter, Musk stated that SpaceX will work on reducing the albedo of

the satellites and will provide on-demand orientation adjustments for astronomical experiments, if necessary. According to an article in *The Atlantic* (2020) “*SpaceX is...actively working with leading astronomy groups from around the world to make sure their work isn’t affected,*” says the company’s spokesperson, James Gleeson.” To test a new coating to lower the satellite reflectivity, one of the satellites in the January launch was used as an experiment. The challenge is that if you make the satellite less reflective, it will tend to absorb heat from the sun rather than reflect it. This will potentially lead to over-heating the satellite causing its premature failure eventually. But as it waits for the results of the new coating, Space-X continues to go ahead with more launches of the older reflective satellites that are bedeviling astronomers. By the time they get to their final orbits, these satellites have dimmed to about the brightness of a +5-magnitude star making them hard for most people to spot. But for telescopes such as the Large Synoptic Survey Telescope, this is blindingly bright! If you want to learn more about this intensely controversial issue, check out these articles by Mack (2020), Koren (2020) and Foust (2020).



Figure 146. An example of an astronomical photograph corrupted by Starlink satellite transits. Starlink satellites streak through images captured by a telescope in Chile. (Credit NSF/National Optical Infrared Astronomy Research Laboratory/CTIO/AURA/DELVE)

To be effective, astronomers are proposing reducing the reflectivity by 15x similar to the difference between fresh snow and asphalt! At least this reduction will preserve the naked-eye character of the night sky that humans have enjoyed for millions of years. A factor of 15 is equal to a stellar magnitude reduction by +3m. But here’s the catch. Smartphone cameras can easily photograph the night sky down to a magnitude of about +7m with the newer ‘Night Mode’ cameras. And with a little extra work can even ‘stack’ these photos to reach magnitudes as faint as +9 or better under dark sky conditions. A quick glance at the *Starlink* predictions from Heavens-Above.com shows that *Starlink* satellites vary from as much as +2m to as faint as +6m so if you

add +3m to them after being treated for reflectivity, that still gives them a range of brightness from about +5m to +9m, which is still within the range of smartphone photography!



Figure 147. *Starlink* satellites appear as diagonal streaks from the center to the lower right through the Great Square of Pegasus, with an **LG-H812** (LG-G4) phone. Settings: 3-seconds at ISO 600. Moon and Venus near bottom right. Powerline cables cross the FOV but are obvious. Upper left dashed track is a plane with running lights. (Credit Clive Nicholson).



Figure 148. (Left) NGC 2070 Tarantula Nebula with satellite streak. Shot with a **Samsung Galaxy S8** through a 10-inch telescope. ISO 320 at 10 seconds. (Credit Nerida Langcake). (Right) *Starlink* satellites shot with a **Huawei P20 Pro** in *Star Trail* mode. (Credit Donald Nool)



Figure 149. The ISS taken in central Slovakia on March, 18, 2020, 18:43 - 19:01 UTC with Sony A7III DSLR camera and a Sony 16-35mm/2.8 lens. Stack of 36 images. (Credit Stanislav Kaniansky)

What you will notice in these shots is that photos taken with the small 4-mm lenses of smartphone cameras in Figure 148 do not look nearly as sharp or bright as the photos taken with professional DSLR cameras like the one used for Figure 149.



Figure 150. Starlink satellites captured on April 22, 2020 from Manchester UK using a **Huawei p30 Pro**. (Credit Tom Urbain)



Figure 151. Starlink satellites captured with a **Hauwei p20** phone at ISO 800 and 300 seconds. (Credit Walter Apollonio).



Figure 152. Starlink satellites with an **LG G8x** phone in March 2020. Taken by combining 40 images each 30 seconds at ISO 200 using *DeepSkyCamera*. (Credit Patrick Heys)

Photography through the eyepiece of a telescope can equalize this difference, especially when, as for shooting the ISS, you use the video camera mode of the smartphone and then combine the images into a stacked, trailed sequence using software. However, the drama of these satellites is in the wide-field experience of seeing them pass through familiar constellations as for Figures 146 and 147. By using *Heavens-Above*, you can find just the right *Starlink* transits across your sky to compose the perfect shot.

14.0 Photographing the Aurora Borealis

Before I launch into a discussion of aurora photography, you first need to understand a bit about aurora so that you can figure out when to go looking for them!

14.1 Aurora colors and forms

Aurora (Aurora Borealis in the Northern Hemisphere, Aurora Australis in the Southern Hemisphere) are caused by energetic particles that strike the nitrogen and oxygen atoms in the upper atmosphere above an altitude of 100 km. With oxygen atoms, you get a bright green emission

line at 557 nm, but for nitrogen atoms above 400 km you can get a deep blue-purple glow from emission near 430 nm. Finally, at altitudes from 200 to 300 km, oxygen atoms emit a red line at 630 and 636 nm, but these red aurora are usually faint because the density of the oxygen at these altitudes is very low. Only during intense solar storms are enough oxygen atoms excited to produce intense red aurora, which folklore has interpreted as fire.

Aurora come in many types from curtains and diffuse glows to pulsating and ‘shooting’ jets. If you are directly under one, you observe the aurora as a corona of light. Aurora do not remain fixed but shift, oscillate and move across the sky at a speed that the human eye-brain can just perceive making for a very dramatic spectacle.



Figure 153. A sampling of auroral forms and colors (Credit Wikipedia/14jbella)

The previous discussion was about how aurora are produced and why they have their colors. For the aurora hunter you also need to understand why they occur because this provides a clue for being at the right place at the right time.

14.2 Space Weather

Aurora are an element of what we call space weather, which is a collection of phenomena driven across interplanetary space by events on the sun. There are two major events called high-speed wind streams and coronal mass ejections (CME) that produce the strongest auroral events. High-speed wind streams occur when openings in the solar magnetic field called coronal holes, allow energetic particles near the solar surface to stream away from the sun on open magnetic field lines. Figure 142 shows one of these holes in an x-ray image of the sun. The hole appears black because the hot x-ray-emitting particles are not trapped near the solar surface but stream out of the hole quickly along the open magnetic field lines. When these field lines, resembling magnetic ducts, pass across earth, the particles can enter earth's magnetic field and cause geomagnetic storms.

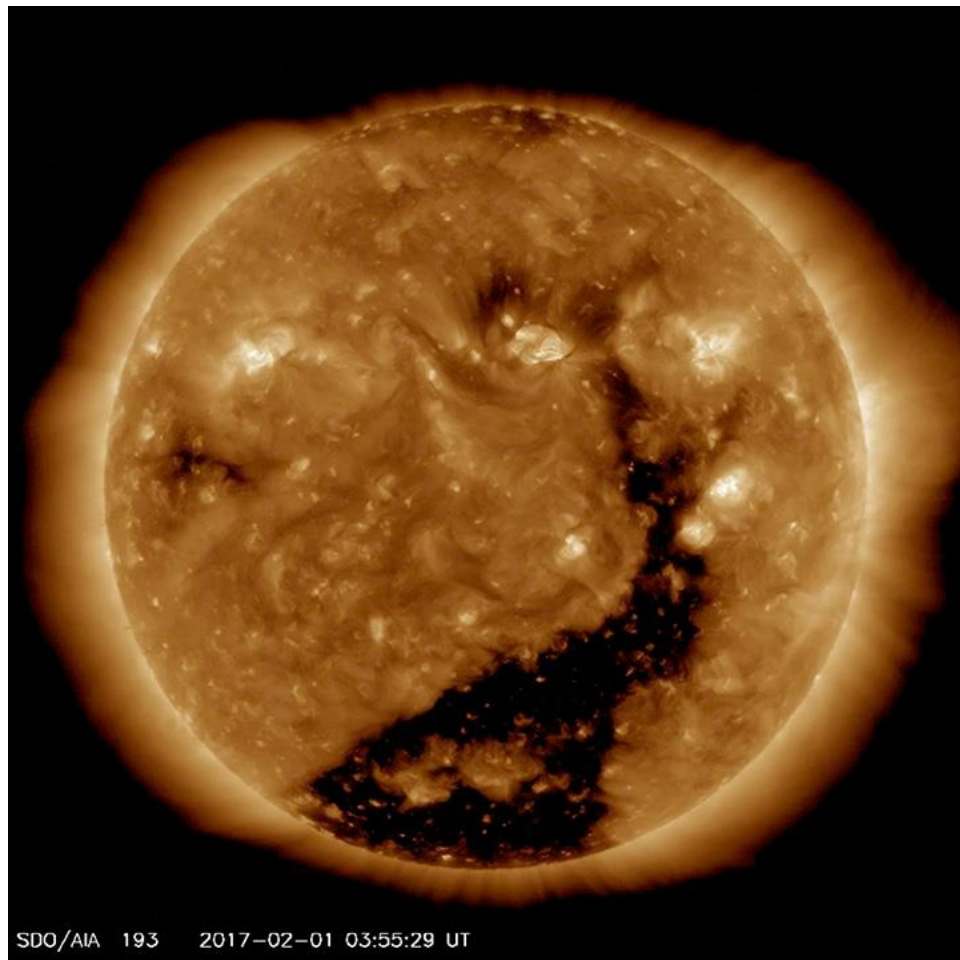

Figure 154. A coronal hole spotted by the SDO spacecraft on February 1, 2017. (Credit NASA)

Because of their speed and density, high-speed streams can produce strong geomagnetic storms leading to aurora. Although more intense on the daytime side of earth, coronal hole aurora can also appear in the evening sky but as large diffuse brightenings with no particular structure. The most dramatic aurora, and the ones we photograph the most, are caused by CMEs.

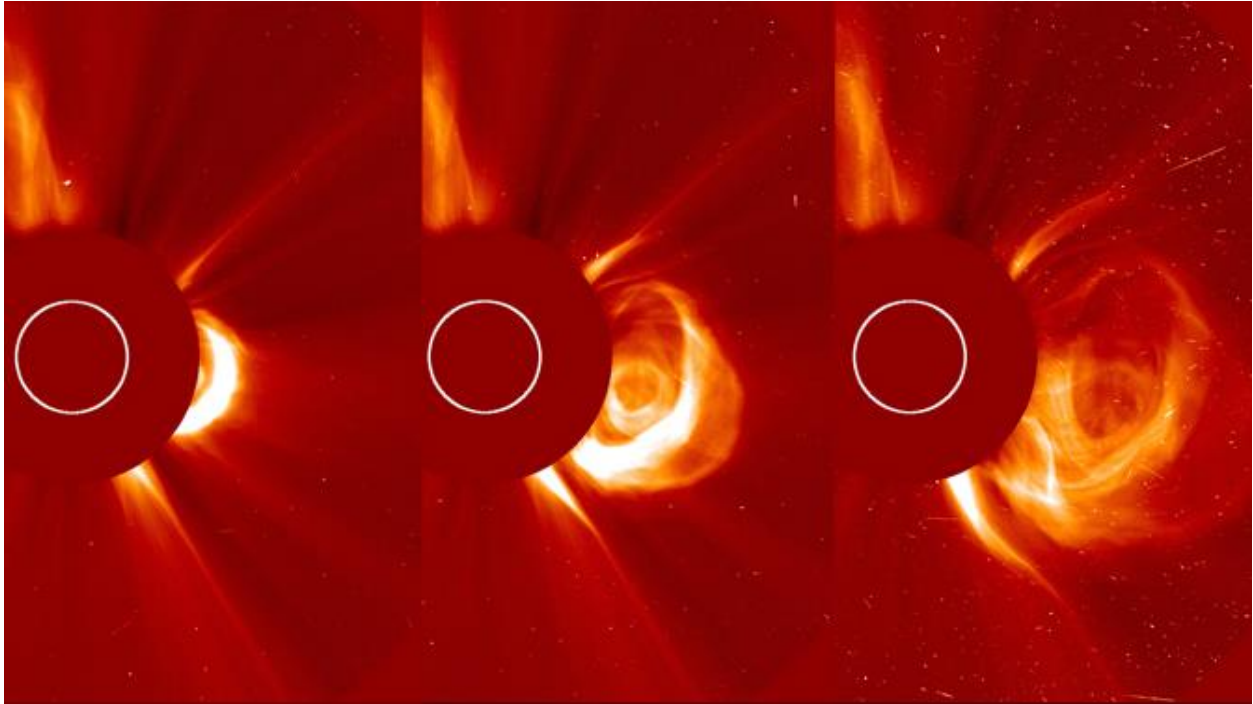

Figure 155. A CME ejected from the sun on May 17, 2012 imaged by the SOHO spacecraft. (Credit NASA/SOHO)

Occasionally, the magnetic field of the solar corona reconnects into a new configuration, launching a multi-billion-ton cloud of solar plasma into space shown in a sequence captured in Figure 155. This magnetic cloud can travel from a few hundred to several thousand km/sec, making the trip to earth's orbit within a few days. NASA satellites have been monitoring the sun for these CMEs since the 1990s, and when spotted can provide advanced notice that one may encounter earth if it was ejected in the right direction. What happens when this cloud actually arrives is complicated but serves as the genesis for the dramatic aurora we love to photograph!

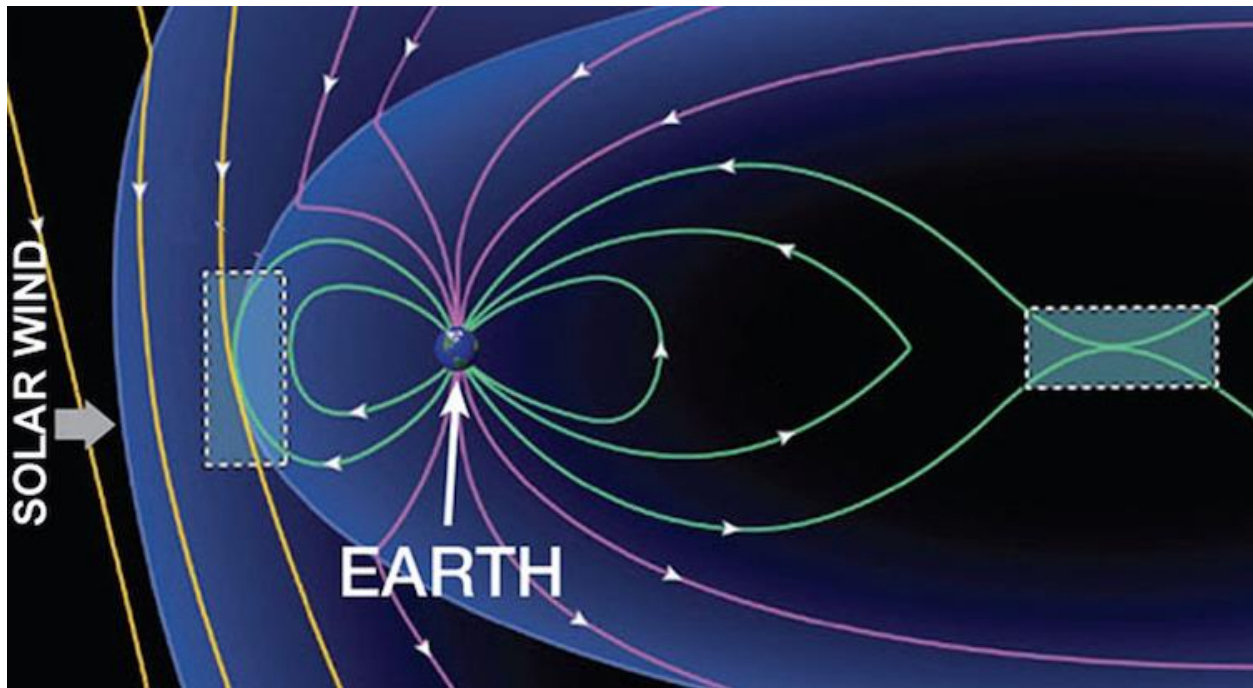

Figure 156. Earth's magnetosphere showing the geomagnetic tail to right of earth (night time) and the tail reconnection region (dotted box). (Credit NASA).

Earth's magnetic field shown in Figure 156 is vaguely comet-like, with the head of the comet occupied by earth and the tail streaming in the opposite direction from the sun. If you were standing on the surface of earth at exactly local midnight, the axis of the geomagnetic tail (magnetotail) would be pointed along your zenith direction. Looking up at the zenith you would be looking down the axis of the magnetotail as it flows into interplanetary space. The magnetotail is not empty but contains vast numbers of energetic particles, electrons, protons and ions trapped by magnetic forces. The origin of these particles are from many sources including the atmosphere above the north and south poles of earth. The lines of magnetic force in the magnetotail map line-by-line onto the north and south polar regions of earth. As you travel from the magnetotail, which starts about 10 R_e from earth's surface, and travel inwards, the magnetic lines of force you encounter connect up with the surface of earth at lower and lower latitudes. For instance, field lines from 6.6 R_e in the geomagnetic equatorial plane intersect the earth between 67.4° and 65.1° , the exact value depending on the dipole tilt angle, season, local time, and geomagnetic activity. The region between 6.6 R_e and about 15 R_e is important because these field lines map into a zone where the greatest numbers of auroral sightings are typically found, called the auroral oval shown in Figure 157.

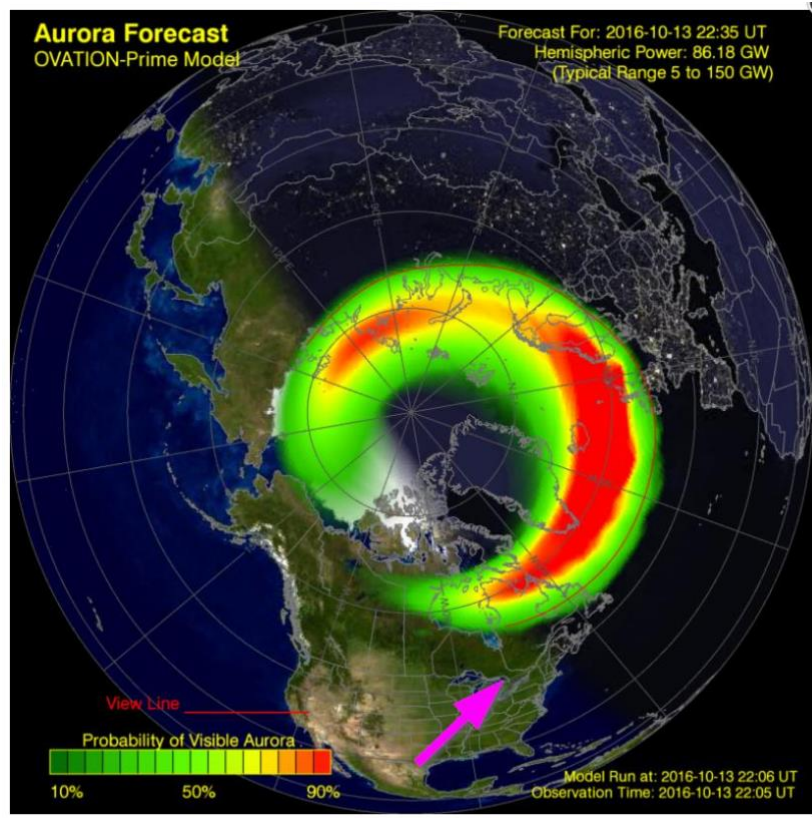

Figure 157. The auroral oval in the Northern Hemisphere for a specific event.

When the CME plasma with its magnetic field encounters earth's magnetic field, it elongates and disrupts the magnetotail, which releases the particles in the magnetotail magnetic field. First the disruption, called a magnetic reconnection event, happens at more distant locations in the magnetotail causing the particles from the more distant field lines to travel towards earth, arriving at higher latitudes. Then as the event progresses, the disruption moves closer to earth along the magnetotail axis, causing the particles to arrive at lower latitudes. This series of events causes the polar oval to form at high latitude near the start of the storm, and slowly expand

towards lower latitudes. For the strongest geomagnetic storms, the lower-latitude edge of the auroral oval can reach as far south as the Gulf of Mexico and the Mediterranean Sea! Once again, it is not the actual solar particles streaming from the sun that cause these night-time aurora by exciting the nitrogen and oxygen atoms, but it is the arrival of the trapped geotail particles from earth's own magnetic field. So how do we tell in advance when a good auroral event will occur?

14.3 When to look for them

Near the sun, modern spacecraft such as NASA's Solar Dynamics Observatory can spot both coronal mass ejections and coronal holes and thereby provide advanced notice that a potential 'solar storm' event may soon take place within the next few days. Services such as spaceweatherlive.com give a number of daily indicators for whether the sun is active and has launched CMEs or high-speed wind streams, as well as a probability for viewing aurora. There are also apps available that perform these functions. Here are a few examples from among many.

SpaceWeatherLive (iOS, free) is the smartphone version of SpaceWeatherLive.com

Magnetic Storms (iOS, Free) provides a simple display of geomagnetic activity using the Kp and A-index.

Aurora Now (iOS, Free) provides a simple display of the Kp index and basic solar wind data related to its magnetic field (Bz and Bt) and speed, which are used to give an aurora probability estimate for your location.

My Aurora Forecasts (iOS, Android) uses your GPS information to provide a display of the current Kp index, a map of the current auroral oval location, and a map of the best viewing locations right now.

Northern Lights Aurora Forecast (Android) provides real time Kp and solar wind data from NOAA along with local cloud cover and aurora visibility probability along with sunrise/set and moon rise/set and phase data.

Northern Eye Aurora Forecast (Android) Like many other apps it provides an assessment of whether you can see an aurora from your location given a variety of space weather indicators.

The visibility of an aurora from your location depends on basically two factors, the Kp index that measures how disturbed earth’s magnetic field is, and how close you are to the auroral oval. The Kp index is a 9-level scale that is created every three hours by combining the magnetic field measurements from 13 magnetic observatories around the world at latitudes from 44 to 60 degrees. The geomagnetic field is always weakly disturbed due to irregularities in the solar wind as it interacts from minute to minute with earth’s geomagnetic field so values between Kp=1 to 2 are common and represent the quiet field conditions. Table 4 from *SpaceWeatherLive* summarizes how the Kp index is related to storm events and aurora visibility. Note that minor storms with Kp=5 occur about 1700 times per 11-year sunspot cycle, while major storms at Kp=9 occur very infrequently but can be observed at very low latitudes beyond the auroral oval region near 60° N.

Table 4 A comparison of geomagnetic activity indices and auroral activity.

Kp	G-scale	Geomagnetic latitude	Auroral activity	Average frequency
0	G0	66° or higher	Quiet	
1	G0	64.5°	Quiet	
2	G0	62.4°	Quiet	
3	G0	60.4°	Unsettled	
4	G0	58.3°	Active	
5	G1	56.3°	Minor storm	1700 per cycle (900 days per cycle)
6	G2	54.2°	Moderate storm	600 per cycle (360 days per cycle)
7	G3	52.2°	Strong storm	200 per cycle (130 days per cycle)
8	G4	50.1°	Severe storm	100 per cycle (60 days per cycle)
9	G5	48° or lower	Extreme storm	4 per cycle (4 days per cycle)

So, what are your chances of seeing an aurora? From lower latitudes such as most of the continental United States, the probability on any given day is very small, especially when solar

activity is not near its peak levels at the top of the sunspot cycle. However, if you live in Canada or in the northern-tier states of, for example, Maine, North Dakota, and Michigan, you can see aurora whenever the Kp index is greater than about 4 or 5 as shown in Figure 156. There is also a seasonal variation in viewing such that the winter months with their longer nights offer better opportunities than summer months in the Northern Hemisphere. Of course, above the Arctic Circle (latitude 66.5°N) the sun is above the horizon from March 21 to September 21 so this eliminates auroral viewing during these months.

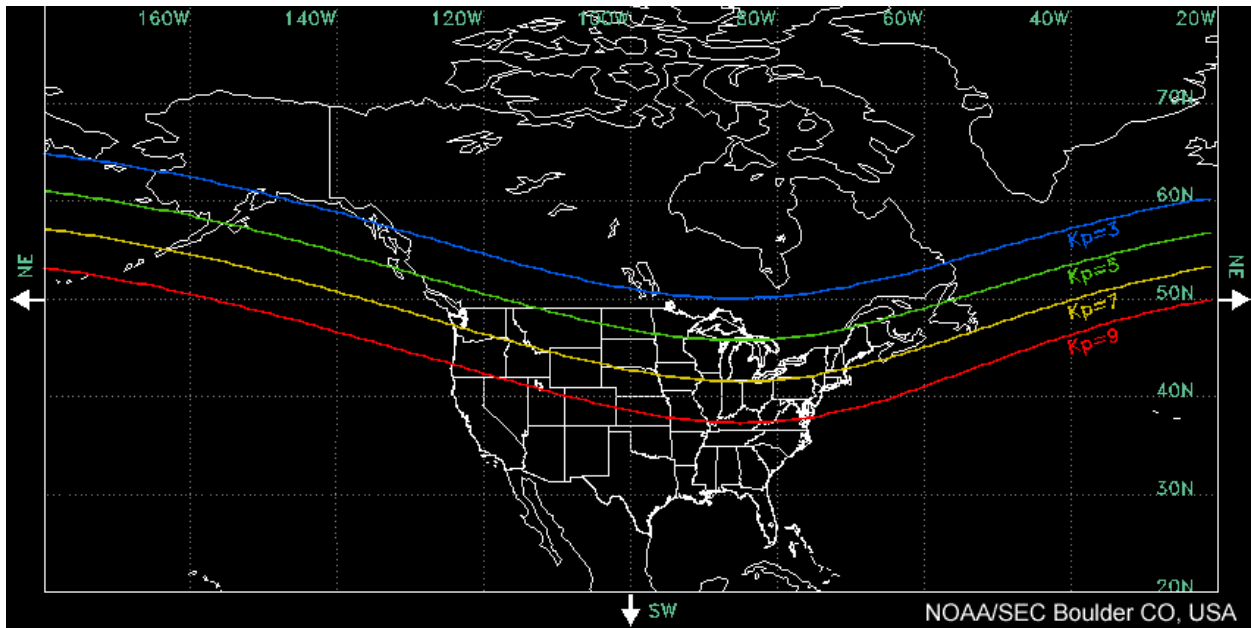

Figure 158. A map of auroral viewing zones and Kp index.

There are websites that provide all-sky camera images of the current auroral activity such as the Geophysical Institute (allsky.gi.alaska.edu) and Aurora Borealis Notifications (auroranotify.com/aurora-links/) that can give you some indication of how common these events are. Generally, for Kp indices from 0-2 you will see aurora that are relatively weak at latitudes near the auroral oval. For Kp between 2-4 you will see active auroral displays usually caused by coronal holes. These can be viewable not just at the auroral oval latitudes but in southern Canada, Alaska and the northern-tier states. During sunspot minimum (2018-2021), the aurora viewing circumstances generally favor the weaker events but these are very common during any given week. As we approach sunspot maximum (2022-2025) major storms with $Kp > 5$ will become common and dramatic displays will be visible at much lower latitudes on a weekly time scale. The most dramatic aurora ($Kp=8$ and 9) can occur as often as every few months in the years just after sunspot maximum and viewable as far south as Arizona and Texas.

14.4 How to photograph aurora.

Aurora photography is very similar to star field constellation photography in which either single-shots or a stacking method work well to bring out the faint details. Best results are for photography away from city lights and obvious sources of light pollution. As for constellation

photography, do not use your camera's 'auto' mode to set ISO and exposure. You need manual control to get the right balance between contrast and detail, and also you may need to adjust the focus. Start with exposure near 10 seconds and ISO 800 and adjust. You may need a third-party app such as *Northern Lights Photo Taker* or *NightCap* to get longer than 10-second exposures, but you should probably not go crazy with the ISO because that will result in grainier pictures. You will also need a tripod or some other means to stabilize your phone during the long exposures.



Figure 159. (Left) Northern Lights against the 'handle' of Ursa Major. *Astro* mode, taken at around 35,000 feet. Shot with a **Google Pixel 4** pressed against the window and a head buff around it to stop cabin reflection. No zoom, exposure around 2 minutes. (Credit Luke Smith). (Right) Northern Lights in Coldfoot, Alaska captured in a single hand-held, 3-second *Night Mode* exposure with an **iPhone 11 pro Max**. (Credit Zach Honig)

Although the temptation is high to take long-exposure photos, aurora are in motion and this motion will make the auroras seem blurry. Experiment with taking shorter exposures closer to one second and do not push the ISO too high to avoid a grainy picture. Take a number of these shorter photos and then try stacking them as you would for nebula or other DSOs.



Figure 160. Aurora (Credit Billy Heather posted May 14, 2019)



Figure 161. Aurora LG G5 camera phone, mounted on tripod with a 25-second exposure at ISO 600. Edited in *Photoshop* (Credit Christian Harris)



Figure 162. Series of Aurora photos taken near the northern shore of Great Slave Lake in the Northwest Territories, Canada on March 20, 2020 at 11:30 PM local time, using a **Samsung Note 8** phone at 10-seconds and ISO 800 with the native camera in Pro mode. Smartphone stabilized with a tripod. (Credit Elizabeth Macdonald)

15.0 Noctilucent Clouds

Noctilucent clouds (NLCs) are high-altitude clouds of ice crystals that reflect sunlight during the twilight hours after sunset. Also called ‘night light clouds’ they have a distinct greenish-blue color unlike clouds in the troposphere. They are located at altitudes of 82 km (51 miles) in the mesosphere, and are visible between late-May and mid-August. Though commonly sighted above latitudes of 50°N, in recent years they have been sighted as far south as Kansas and even Los Angeles, California. A combination of water-laden air flowing up from the troposphere along with meteoritic dust provide nucleation sites for ice crystals that then scatter sunlight to produce the bluish coloration. They typically appear at low angles to the horizon about 1-2 hours after sunset or before sunrise. If you want to join a NLC citizen science program, visit NLC CAN AM at <https://skyandtelescope.org/clubs-organizations/nlc-can-am-noctilucent-cloud-observers/> and fill out their observing form!



Figure 163. Noctilucent clouds over Denmark. **Huawei P30 Pro** with *Nightmode* at 1/17-sec and ISO 3200. (Credit Claus Sorenson)

16.0 Astrophotography for the sight-impaired.

The idea that people who are sight-impaired or even fully blind would take up photography seems on the face of it an implausible idea fraught with many obvious difficulties. How does one frame a photograph and make an interesting composition? How do you center the subject and focus the camera properly? How do you adjust the exposure and f/stop for the best light levels? More importantly, who do you share the final product with? It is unlikely that within the sight-impaired community and your friends there is much sharing of photographs, so this is a product that will most likely be shared with sighted friends and family members to tell the story of where you were in your travels to interesting places.

Everyone wants to share vacation photographs and in this regard the sight-impaired

community is no different than any other! It is worth noting, also, that ‘sight-impaired’ belies a whole host of conditions not just the one, obvious, extreme situation of complete light blindness. Also, many in this community may have started out sighted but through any of a variety of medical conditions gradually lost their sight over their childhood or adult years. So, photography is not such a peculiar interest or hobby among the sight-impaired community as one might naively imagine.

Astrophotography presents several unique challenges that ordinary photography does not. Fortunately, smartphone cameras do come equipped with spoken-word interfaces that allow cameras to be operated by sight-impaired photographers. For example, Apple’s *VoiceOver* screen-reader is included in all iOS devices. *VoiceOver* reads the different buttons and options as you drag and flick your finger across the screen. You can adjust the ISO and exposure speed using *VoiceOver* with little difficulty.

Solar photography takes place during the daytime, but all other astrophotography is a night-time activity. Those suffering from retinitis pigmentosa have night blindness and so must find alternative methods for selecting a subject, but since you will be photographing with a telescope, this condition is not a significant problem at least in principle.

The most common subject matter for astrophotography is objects in the sky rather than objects on the ground, so focusing the camera at its extreme ‘infinity’ focus presents a significant problem. Even cameras that auto-focus sometimes do a poor job of truly returning pin-point star images, or images captured through a telescope’s eyepiece. Those who are diagnosed with 20/200 or poorer vision or declared legally blind will be challenged to overcome this obstacle. Older smartphones have lenses that are mechanically fixed such that anything between about 1-meter and infinity will be in focus. They also have software that can sharpen the image by using various mathematical techniques. Modern smartphones all have internal movable lenses that you do not see on the outside case, and move fractions of a millimeter to optimize focus without human intervention. Some camera apps let you manually adjust focus, and these are especially valuable for astrophotography, but decent images can be obtained even without human intervention.

Although there are a vast number of resources in astronomy content for the sight-impaired, astrophotography represents something of an ‘extreme sport’ in this hobby. Like other extreme sports, you need to think carefully about what your goal is and how you will determine whether you have succeeded or not. Like all other subjects, practice makes perfect, and seemingly insurmountable barriers can often be overcome with creativity and ingenuity!

17.0 NASA Space Photography

Ground-based telescopes produce spectacular images of astronomical objects, especially from the larger research observatories, but some of the most dramatic images in recent decades have been

created from NASA's Hubble Space Telescope and various solar observatories such as the Solar Dynamics Observatory. Amazing planetary, lunar and asteroidal images have also been captured by a veritable armada of spacecraft such as Voyager, Galileo, Cassini, New Horizons and the Mars rovers to name just a few.

It is worth mentioning that the techniques used in creating these astronomical images are not unlike the methods you are using with your smartphone. Spacecraft use digital array cameras whose pixelized information is telemetered back to Earth and assembled into images following a variety of image-processing steps that involve calibration, flat-fielding, and bias correction among other techniques. The professional goals are, however, different from simply creating a 'beautiful' image. What is keenly important is the calibration step that allows the astronomer to relate a specific quantity of light in a specific spectral range to a specific number of 'counts' in an image pixel. The end result is that the astronomer can measure the brightness of an object or surface area in an image and relate it to physical units of light intensity such as 'ergs per square centimeter per second per steradian per micron'. The calibrated physical unit measured in the image pixel can then be related back to a particular mathematical model of what its brightness should be. Of course, a by-product of this careful analysis and calibration work is often a beautiful 'true color' image of the object suitable for framing in your living room!

Some of the largest collections of astronomical images can be found at the following web sites whose URLs were functioning as of November, 2020. If the link is inoperative, just use Google and search under the mission name with 'gallery' or 'images' added as a search word.

Sun:

Hinode - https://www.nasa.gov/mission_pages/hinode/gallery.html

Solar Dynamics Observatory - <https://sdo.gsfc.nasa.gov/gallery/main>

Solar and Heliospheric Observatory - <https://sohowww.nascom.nasa.gov/gallery/>

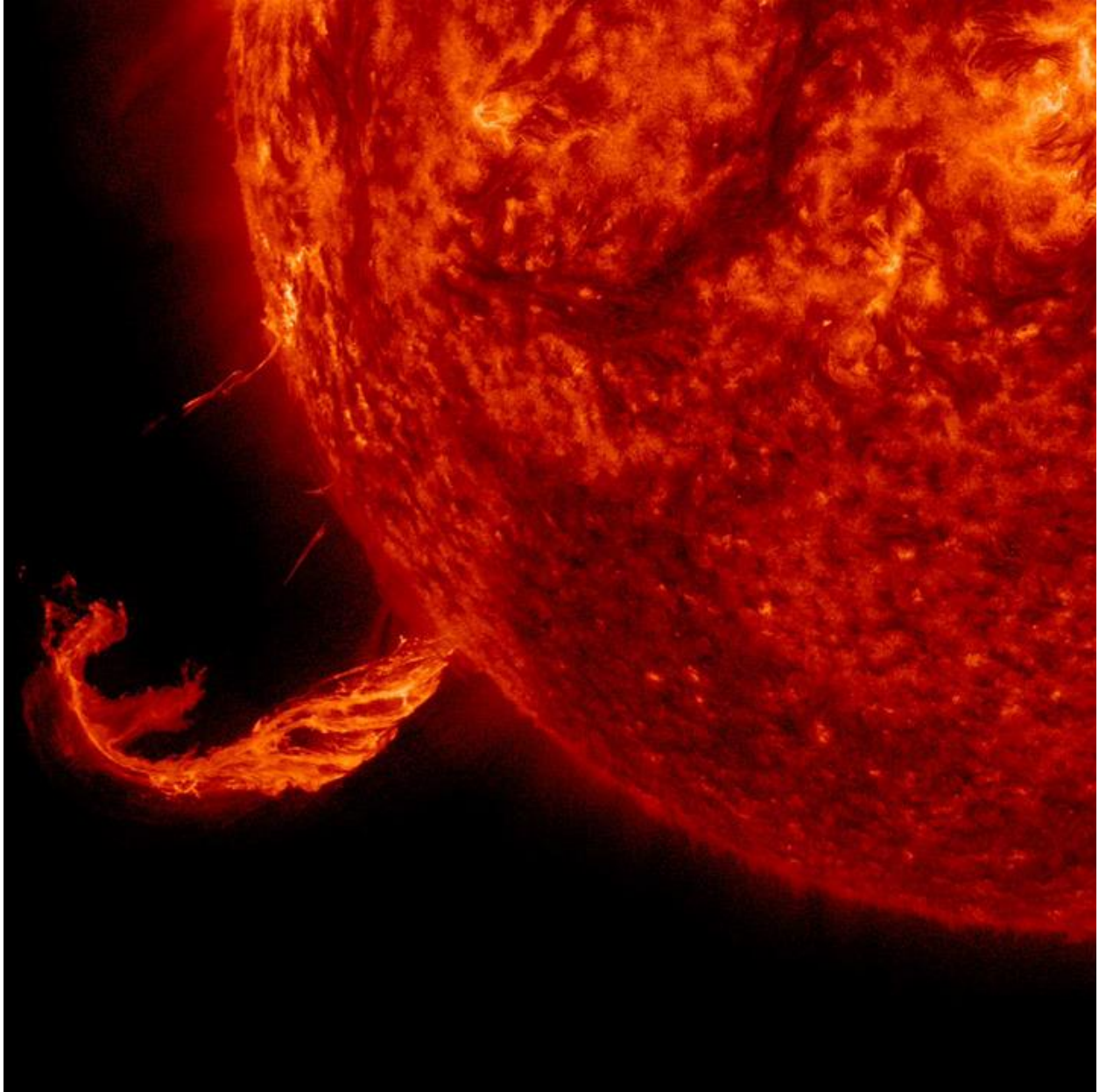

Figure 164 - The Sun blew out a coronal mass ejection along with part of a solar filament over a three-hour period (Feb. 24, 2015). The activity was captured in a wavelength of extreme ultraviolet light. Because this occurred way over near the edge of the Sun, it was unlikely to have any effect on Earth. Credit: Solar Dynamics Observatory, NASA.

The Solar Dynamics Observatory is located in Earth orbit. Figure 164 shows an example of what its cameras can pick up when looking at the sun. This image was shot at a wavelength of 304 nm with its high-definition camera. A typical HDTV screen has 1280 x 720 pixels; SDO's images have a 4096x4096 (e.g. 4k x 4k) format. The pixel count is comparable to an IMAX® movie, but SDO takes one image every second and scans through 10 different spectral bands to create a multi-wavelength movie of solar activity 24/7/365. This results in about 1.5 terabytes of

data per day. The Atmospheric Imaging Assembly (AIA) telescope is a 20-cm reflecting telescope with a 412-cm focal length and a 41-arcminute field of view. The pixels have a resolution of 0.6-arcseconds, which corresponds to a linear resolution of 450 km at the sun. The pixel wells have a capacity of 150,000 electrons; about 50-100 times larger than typical smartphone sensors.

Moon and Planets:

Cassini-Saturn - https://www.nasa.gov/mission_pages/cassini/images/index.html

Galileo Jupiter - <https://photojournal.jpl.nasa.gov/mission/Galileo>

Huygens – Titan - <https://photojournal.jpl.nasa.gov/spacecraft/Huygens%2BProbe>

Juno – Jupiter - https://www.nasa.gov/mission_pages/juno/images/index.html

Lunar Reconnaissance Orbiter - <https://www.lroc.asu.edu/posts>

Mars Reconnaissance Orbiter - https://www.nasa.gov/mission_pages/MRO/images/index.html

MESSENGER- https://www.nasa.gov/mission_pages/messenger/multimedia/messenger_gallery.html

Mariner 10 - <https://photojournal.jpl.nasa.gov/spacecraft/Mariner%2B10>

Mars Global Surveyor - <https://mars.nasa.gov/mgs/msss/camera/images/>

New Horizons - https://www.nasa.gov/mission_pages/newhorizons/images/index.html

Voyager - <https://voyager.jpl.nasa.gov/galleries/images-voyager-took/>

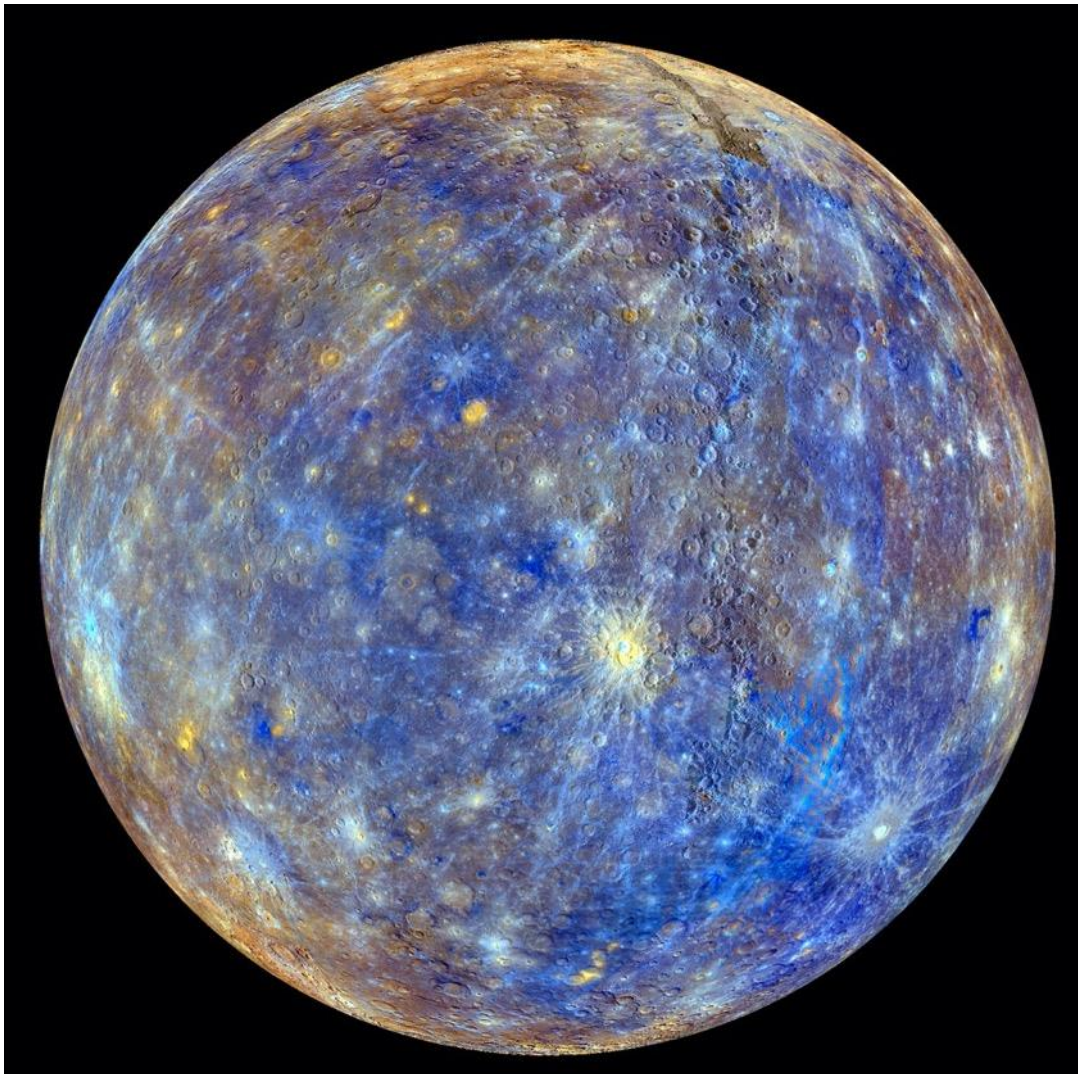

Figure 165 False color image of Mercury taken by the MESSENGER spacecraft revealing the different types of mineral content, along with a moon-like cratered surface.

The MESSENGER spacecraft entered Mercury's orbit in 2011. During the next four year's it returned dramatic images of Mercury's surface in addition to performing a mineralogical remote survey of its surface. Its two CCD cameras in the Mercury Dual Imaging System (MDIS) provided narrow-angle (NAC) and wide-angle (WAC) imagery. The NAC is a 1.5° field-of-view off-axis reflector, coaligned with the WAC, a four-element refractor with a 10.5° FOV and 12-color filter wheel. The focal plane electronics of each camera are identical and use a 1,024×1,024 pixel CCD format. The NAC provides 500-meter resolution while the WAC provides 2km resolution.

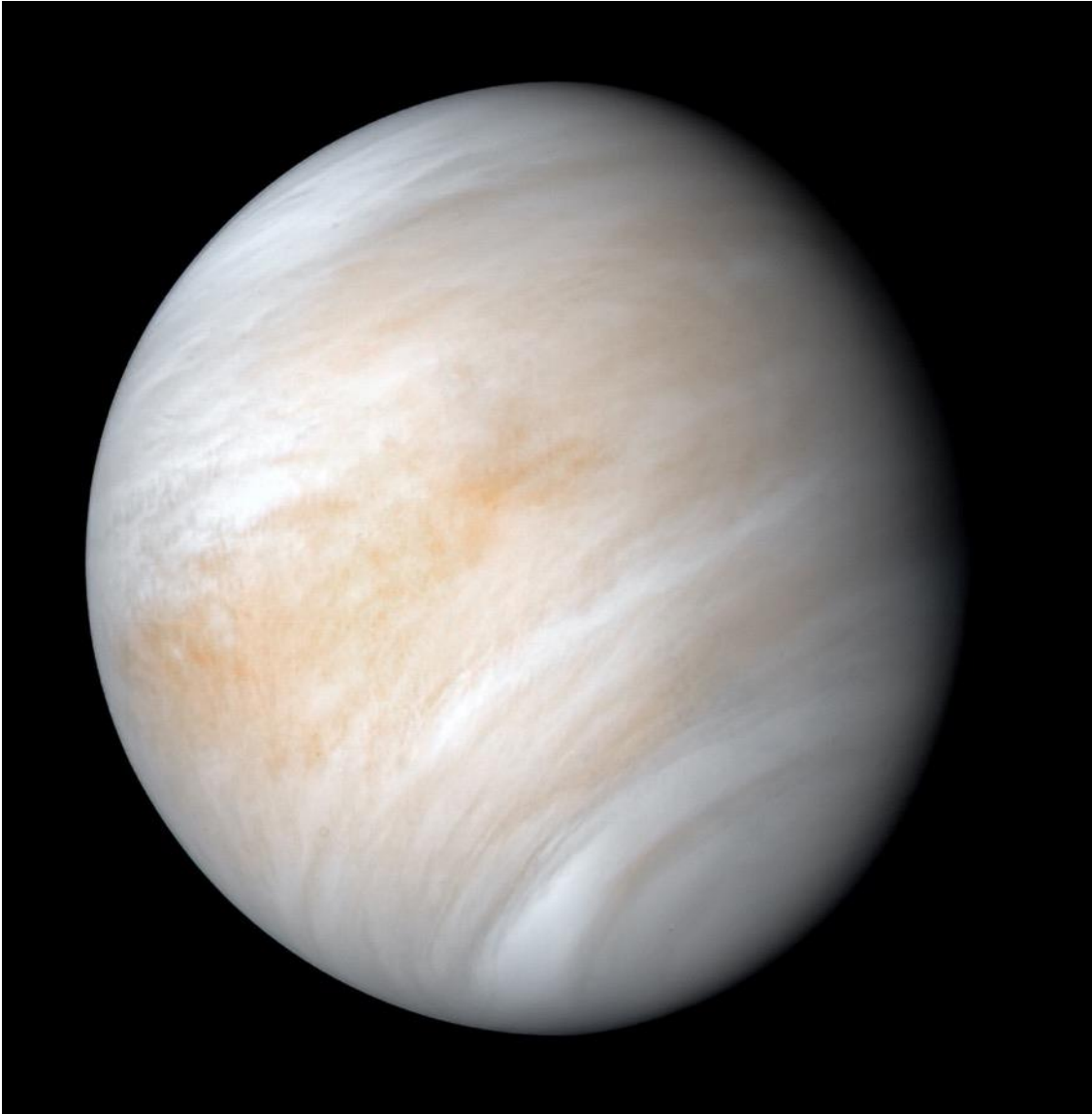

Figure 166 This image of the atmosphere of Venus was produced from the original Mariner-10, 1974 data by remastering and using modern, advanced image processing techniques to bring out the delicate cloud structure.

The Mariner 10 spacecraft flew past Venus in February 1974 and captured dramatic images of the clouds, revealing considerable details. The Television Photography Experiment, consisted of two 15 centimeters (5.9 in) Cassegrain telescopes feeding vidicon tubes. The data was telemetered back to Earth and recovered as a TV-style image, which was then photographed to create a print form. Similar views were captured in 2016 by the Japanese Akatsuki Venus Climate Orbiter spacecraft, which used an Ultraviolet Imager (UVI) with a 1024x1024 format and 12-degree field of view to penetrate the cloud deck and image the sulfur dioxide clouds.

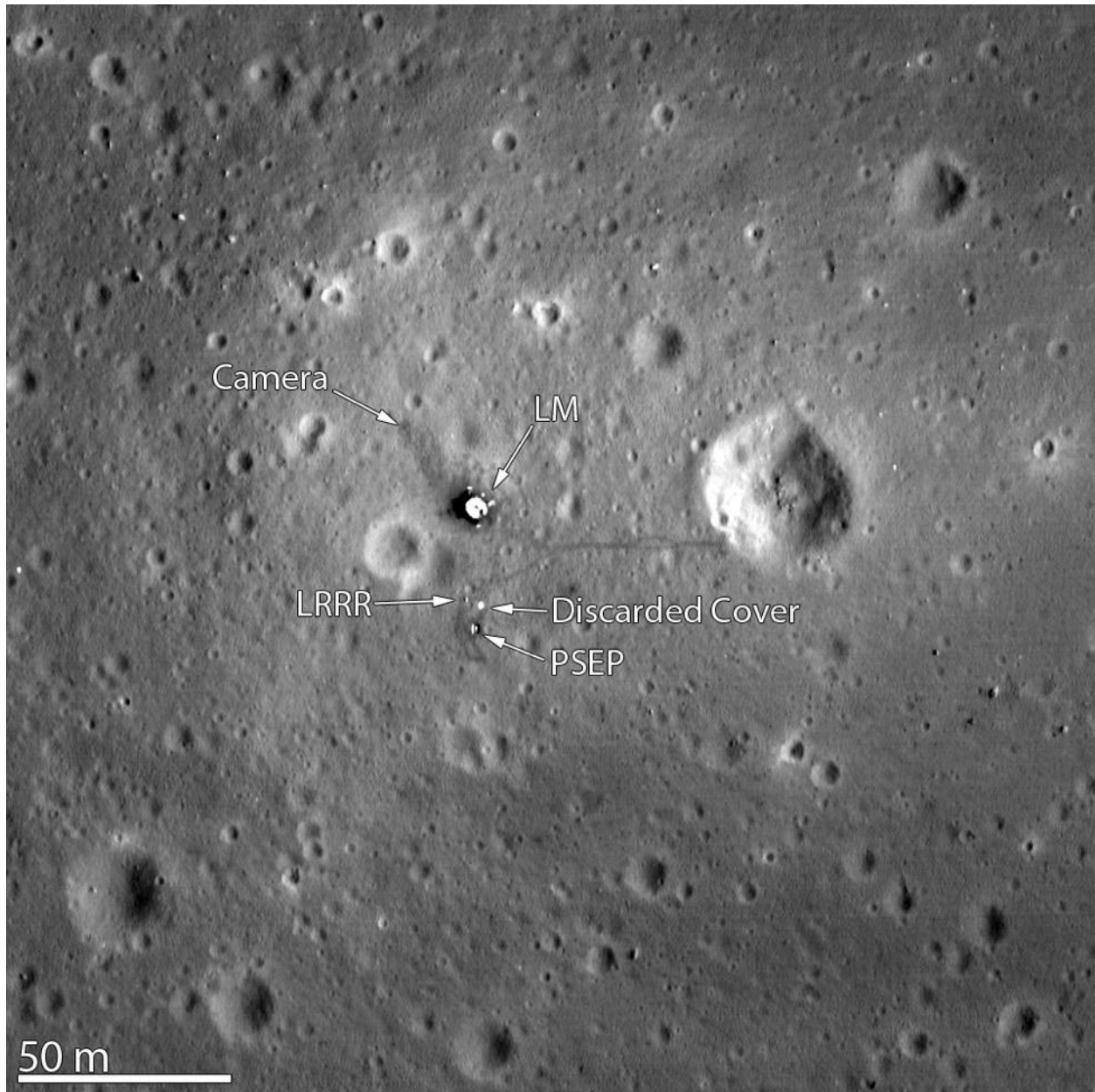

Figure 167 This LRO image shows details around the Apollo 11 landing site including the tracks made by the astronauts as they deployed the instrument packages. LRO has been very effective in discovering the landing sites of all the Apollo missions as well as those of missions such as the Soviet Lunokhod and the Chinese Chang'e rovers. It can also detect new impact craters.

The Lunar Reconnaissance Orbiter Camera (LROC) has two cameras; one for narrow-angle shots and one for wide-angle shots. The narrow-angle system is a f/3.6 Ritchey-Chretien system with a 19.5-cm aperture. The imager is a 1x5064 linear array scanned along the ground track of the spacecraft to create a digitized, 12-bit, 2-d image. The pixel resolution on the lunar surface at closest orbital approach is about 0.5 meters.

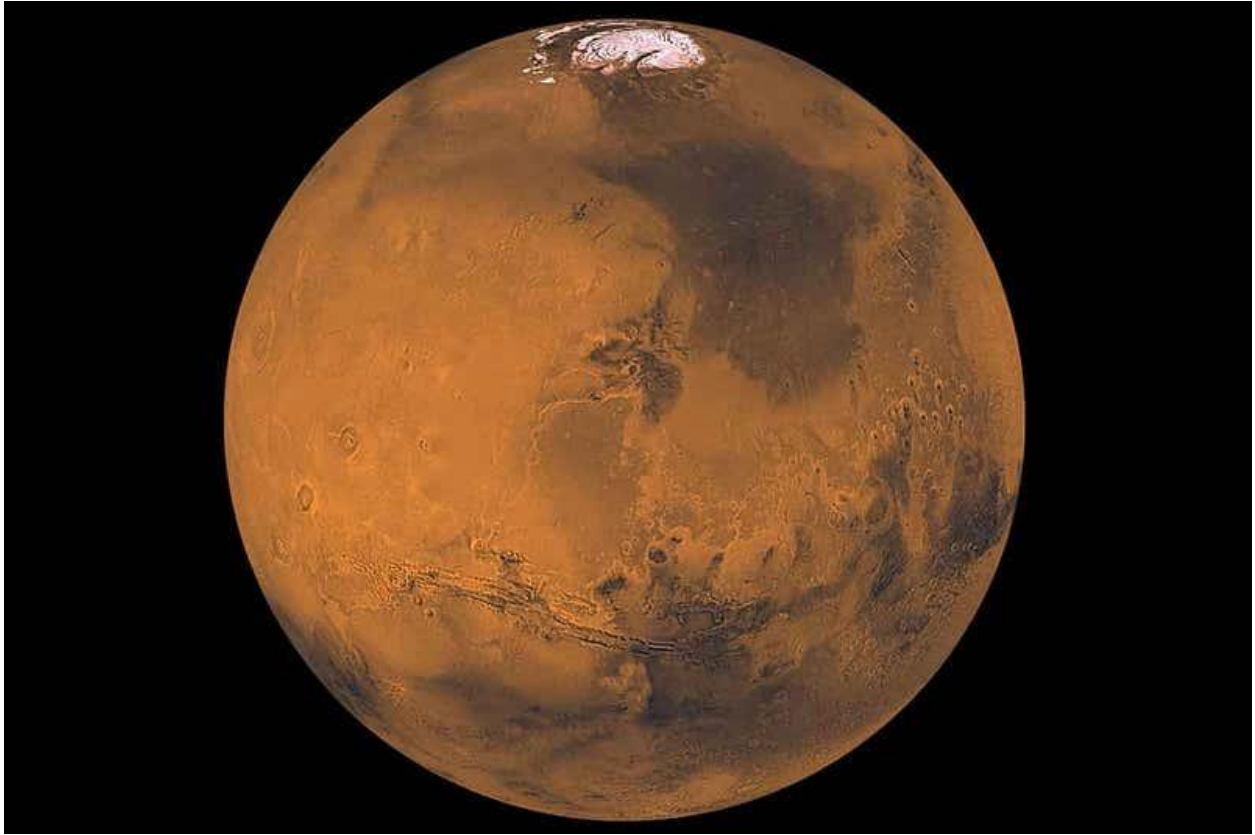

Figure 168 Image of Mars taken by the Viking Orbiter spacecraft in 1976.

The Viking Orbiters, which arrived at Mars in 1976, provided numerous high-resolution images of the full-Mars disk as well as resolving features on the Martian surface as small as 300 meters across. The Visual Imaging System (VIS) cameras, like other pre-digital systems, read out the focused image of Mars on a vidicon tube and telemetered the data back to Earth at 2 megabits/sec, and with an equivalent format of 1182x1156 pixels. The next spacecraft following the Vikings to work successfully from orbit was the 1997 Mars Global Surveyor. During its nine years of successful operation in Mars orbit, its camera (MOC) returned over 243,668 images with resolutions as high as 1.4 meters per pixel. The camera images had a format of 1024 x 9600 pixels. The narrow-angle assembly, which comprises the principal part of the instrument, was a 35 cm aperture, 3.5 m focal length (f/10) Ritchey-Chretien telescope with a 0.4 degree field of view.

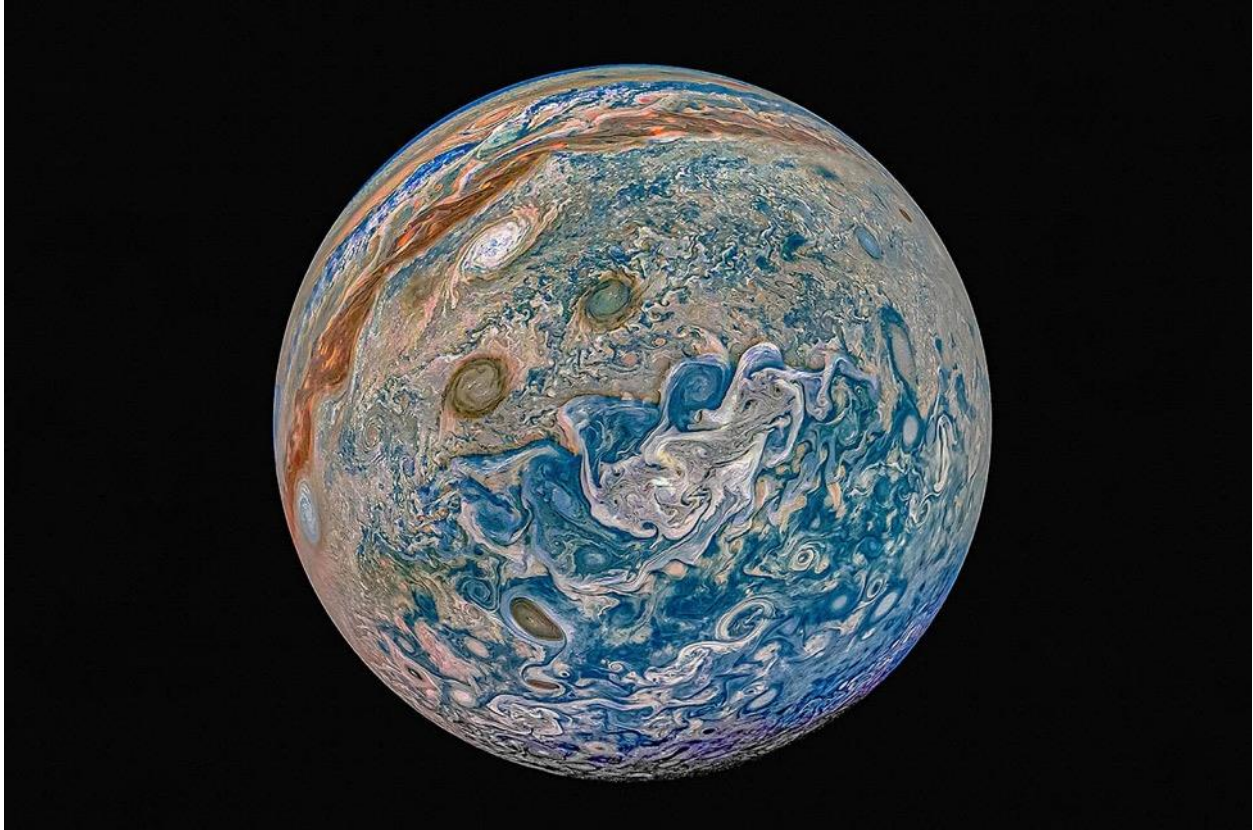

Figure 169 The Juno spacecraft has taken thousands of images of Jupiter from its highly-elliptical orbit that passes over the polar regions of the planet. The images taken from an angle impossible to duplicate from Earth reveal an atmosphere covered by cyclonic storms and turbulence. (NASA/JPL-Caltech/SwRI/MSSSIImage processing by Prateek Sarpal, copyright CC NC SA)

The Juno spacecraft arrived at Jupiter in 2016 and began its study of the Jovian radiation belts. Almost as an after-thought, a small camera was added to the spacecraft design but over time has returned some of the most scientifically-productive images from any spacecraft. It was included primarily for public science and outreach, and to increase public engagement. The JunoCam is a radiation-hardened imaging array with a 1600x1200 format. It's 58-degree field of view translates into a resolution at closest approach (4,300 km) of 15 km per pixel. It also images in four spectral bands.

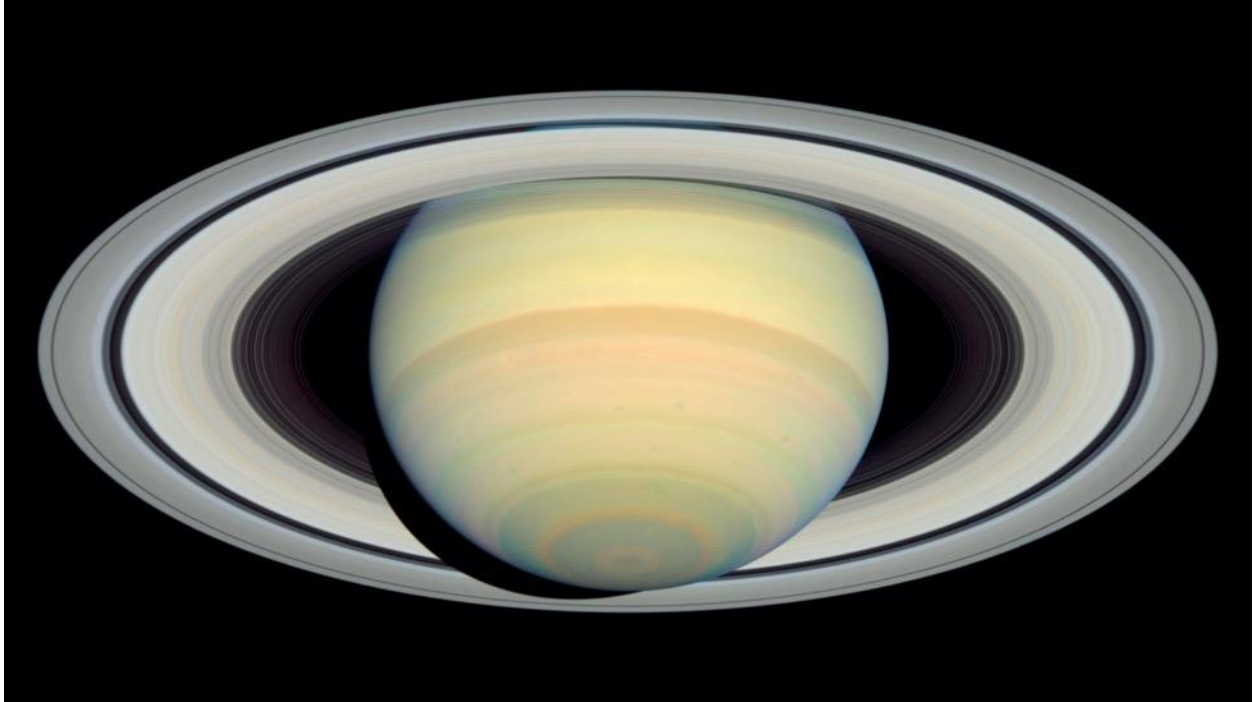

Figure 170 The Cassini/Huygens mission arrived at Saturn in 2004 and for the next 13 years it captured over 100,000 images of the planet, its rings and its satellites.

The Cassini spacecraft with the piggy-backed Huygens Probe carried a wide-angle and a narrow-angle imaging system, which has become the standard fare for spacecraft systems for several decades. The WAC is based upon a 20-cm, $f/3.5$ refractor, has 18 filters, and a field-of-view of 3.5 degrees. The NAC uses a 20-cm, $f/10.5$ reflector with 24 filters and a field of view of 0.35 degrees. Both use 1024×1024 CCD imaging arrays that provides 12-bit intensity digitization and a dynamic range of 4096 levels. Imaging scales on the targeted satellites were as small as a few tens of meters/pixels; on the rings and atmosphere, ~ 1 km/pixel.

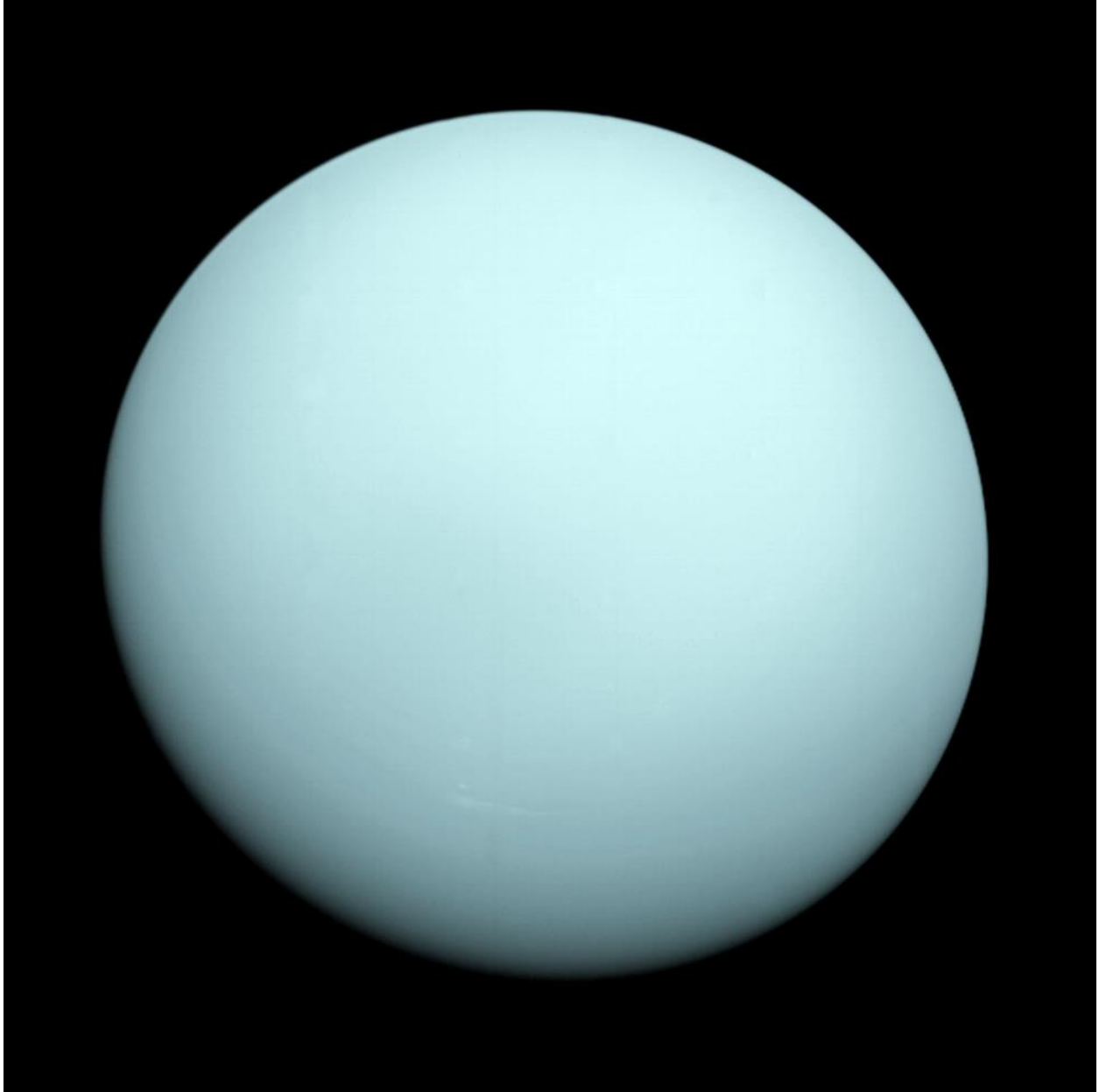

Figure 171 Uranus remains a featureless world even viewed by the Voyager 2 spacecraft which flew by this planet in January, 1986.

The Voyager 2 arrived at Uranus for a fly-by of this planet in January, 1986 and captured over 100 images of its clouds and satellites during its brief encounter. The spacecraft Imaging Science System consists of two television-type cameras, each with 8 filters in a Filter Wheel mounted in front of the vidicons. One has a low resolution 200 mm wide-angle $f/3$ lens, while the other uses a higher resolution 1500 mm narrow-angle $f/8.5$ lens. Resolutions of about 2 km were achieved during close approaches to the moon Miranda.

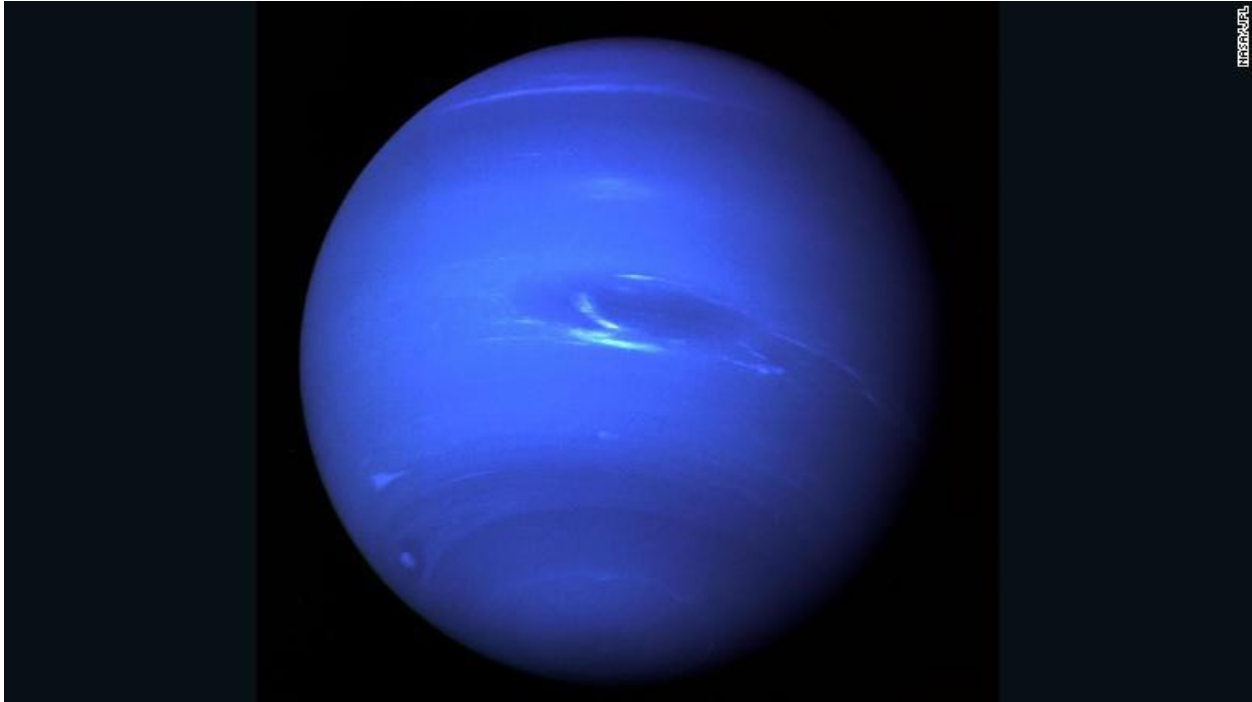

Figure 172 This image of Neptune taken by the Voyager 2 spacecraft on August 28, 1989 is perhaps the most striking image of this planet so far.

Neptune as imaged by the Voyager 2 spacecraft reveals tantalizing atmospheric features. No other spacecraft have returned to this world since the Voyager encounter, although the Hubble Space Telescope can take images of Neptune such as the one in Figure 173 that in some instances rival what the spacecraft could produce.

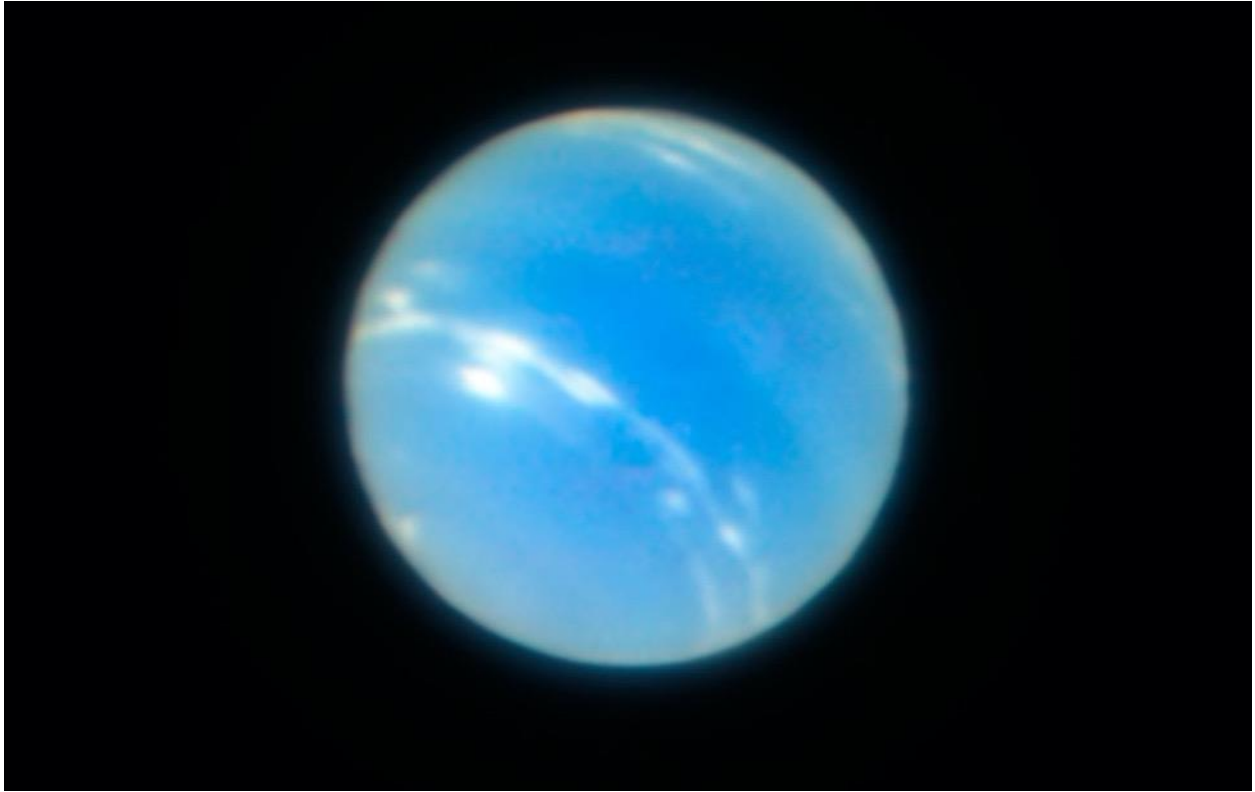

Figure 173 This image of Neptune taken by the Hubble Space Telescope from a distance of 4.3 billion km rivals the Voyager 2 image taken from only 50,000 km. The image was produced by the Hubble Wide Field Camera 3 (WFC3 installed in 2009), which has a 2048x4096-format array with pixel resolutions of 0.04 arcseconds.



Figure 174 A spectacular, and historic, image of Pluto showing details never before seen through telescopic observations. No one thought that a body so cold and far away from the sun would have such a complex surface topography because of the lack of internal heating. However, the massiveness and closeness of its moon Charon produces tides in the body of Pluto that dissipate enormous amounts of energy and provide the internal thermal heating to drive the crustal changes.

The \$700 million, New Horizons spacecraft flew-by Pluto in July, 2015 and captured breath-taking images of this distant dwarf planet's surface. The f/8.7 Ralph multi-color camera has an aperture of 75 mm and an effective focal length of 685 mm. The imaging array has a format of 5028x128 and creates 5.8-degree wide 2-d images by sweeping across the field of view using spacecraft motion. The highest resolution is about 3 km. Because of the enormous distance to

Pluto, over 4.7 billion km from Earth, the telemetry system had to operate at a very slow rate. This meant that it took 4 months to transmit all of the images in its 8 gigabyte image buffer back to Earth.

Asteroids and Comets:

Dawn - <https://solarsystem.nasa.gov/missions/dawn/overview/>

NEAR - https://nssdc.gsfc.nasa.gov/planetary/mission/near/near_eros.html

Osiris-Rex – <https://www.asteroidmission.org/galleries/spacecraft-imagery/>

Deep Impact - <https://photojournal.jpl.nasa.gov/spacecraft/Deep+Impact>

Rosetta (ESA) - <https://photojournal.jpl.nasa.gov/spacecraft/Rosetta>



Figure 175 Dawn spacecraft image of the asteroid Ceres.

The Dawn spacecraft encountered the asteroid Ceres on March 6, 2015. It used an $f/7.9$ refractive camera system with a 150-mm focal length and an image format of 1024x1024 pixels. This combination provided a 5.5-degree field of view. At closest approach to Ceres, the images could resolve details as small as 66-meters per pixel.

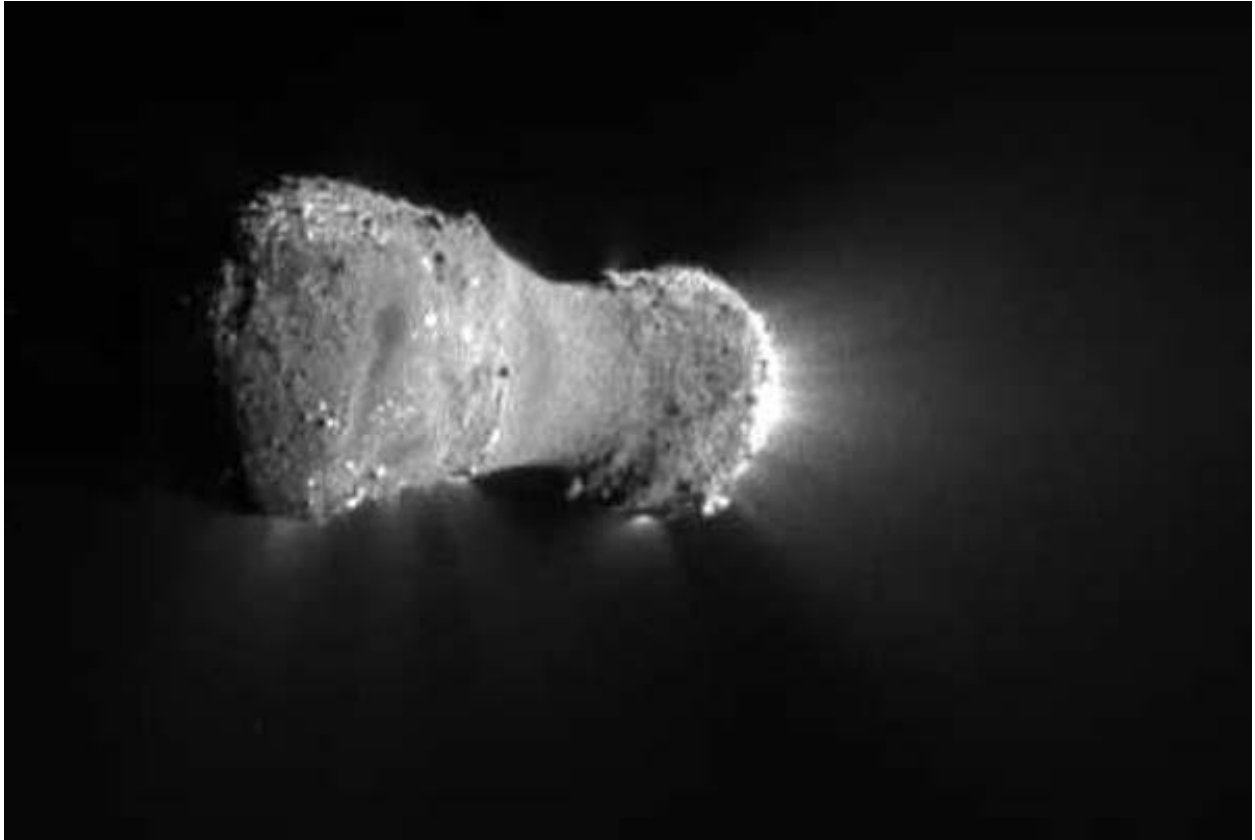

Figure 176 One of several close-ups of the nucleus of 103P/Comet Hartley 2, taken on November 4, 2010, by NASA's Deep Impact spacecraft. Note the numerous jets of gas emanating from the elongated body.



Figure 177 Comet 67P/Churyumov-Gerasimenko taken from a distance of about 90 kilometers at a resolution of 7 meters per pixel.

The European Space Agency's Rosetta spacecraft arrived at Comet 67P in 2014. Its lander, "Philae," would make the most detailed study of a comet to date. Nearly 100,000 high-resolution images of the comet were produced.

Deep Space:

Chandra Observatory - https://www.nasa.gov/mission_pages/chandra/images/index.html

Hubble Space Telescope - https://www.nasa.gov/mission_pages/hubble/multimedia/index.html

Spitzer Space Telescope - https://www.nasa.gov/mission_pages/spitzer/images/index.html



Figure 178: A spectacular image of the barred spiral galaxy NGC-5643 located 60 million light years from Earth in the constellation Lupus.

The Hubble Space Telescope has returned over 100,000 images of distant astronomical objects, which are seen in dramatic clarity due to the 0.04-arcsecond resolving ability of the optical system.



Figure 179 The Spitzer Space Telescope operates at infrared wavelengths and can form images of young stars deeply embedded in obscuring clouds of dust that not even the Hubble Space Telescope can penetrate. This image shows a cluster of young stars forming in the Serpens molecular cloud.

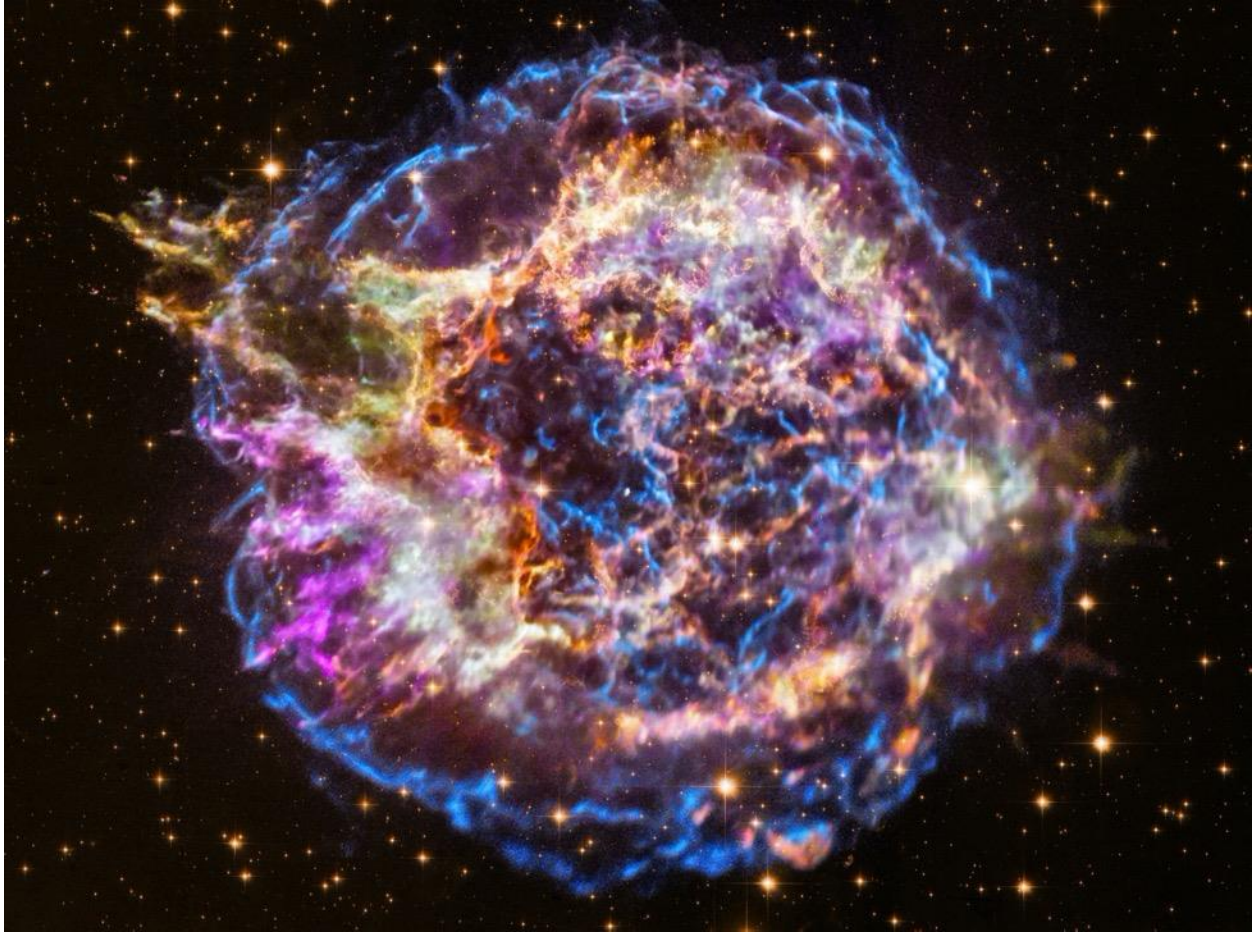

Figure 180 This is an image of the Cassiopeia A supernova remnant imaged by the Chandra X-Ray Observatory.

18.0 Citizen Science Projects

Citizen science is an activity as old as astronomy itself. Long before astronomy became a formal career with major institutions and observatories, it was the ‘amateur’ astronomer that studied the skies for both entertainment and to learn about its contents. Today there are hundreds of projects that the general public can join, in which they work alongside professional astronomers to make new discoveries. The advent of smartphone cameras capable of recording the night sky is a relatively new technology that is only now being tentatively explored for its citizen science capabilities. Here are some recent projects in which you can participate by taking photos and contributing them to various archives for later analysis.

18.1 Smartphone Astrophotography

URL <https://darksky.scistarter.org/index/Astrophotos-Lunar-darksky-index>

As we have explored in this book, most owners of telescopes eventually want to have the experience of creating their own photographs of astronomical objects seen through the eyepiece. This usually means buying expensive DSLR cameras costing hundreds of dollars. You can



Figure 181. Typical image of the moon taken by astrophotographers. (Credit Bhushan Karmakar).

carefully hold your smartphone 'back-camera' lens to a telescope eyepiece to get nice photos of the moon and planets, but for best results, consider getting an eyepiece adapter such as the one by *Solomark*, which can be purchased at Amazon.com.

If you own your own telescope, you are already ahead of the game. If you do not have a telescope, your local library may be able to help you out! The Library Telescope Program, run by the Astronomical League, lets you borrow a 4.5-inch Orion *Starblaster* telescope for up to two weeks to pursue your interests. For more information visit

<https://www.astroleague.org/content/library-telescope-program> or
<https://www.librarytelescope.org/>.

18.2 Globe at Night

URL <https://darksky.scistarter.org/index/globe-at-night-darksky-index>

Globe at Night is an international citizen-science campaign to raise public awareness of the impact of light pollution by inviting citizen-scientists to measure and submit their night sky brightness observations. It's easy to get involved - all you need is computer or smart phone. So far in 2020 citizen scientists from around the world have contributed 5,177 data points. More than 180,000 measurements have been contributed from people in 180 countries over the last 12 years, making *Globe at Night* the most successful light pollution awareness campaign to date!

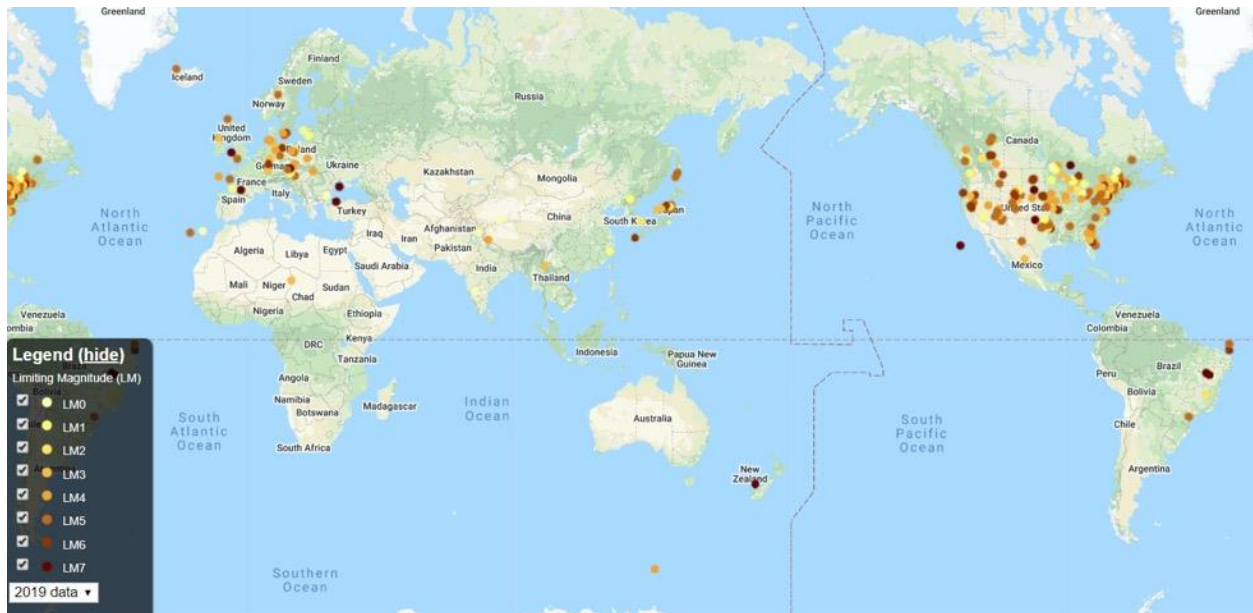

Figure 182. The 2019 map of sky brightness and light pollution (Credit Globe at Night)

You can explore the last 12 years of data in their interactive data map (Figure 163), or see how your city did with their regional map generator. The *Globe at Night* website (globeatnight.org) is easy to use, comprehensive and holds an abundance of background information. The database is usable for comparisons with a variety of other databases, like how light pollution affects the foraging habits of bats

18.3 Night Sky Light Pollution

URL <https://darksky.scistarter.org/index/Astrophotos-MLP-darksky-index>

Thousands of people around the world are studying how city light pollution is robbing us of a view of the starry sky. The *Globe at Night* program (<https://www.globeatnight.org/>) and the International Dark Sky Association (<https://www.darksky.org/>) coordinate these world-wide observing sessions either by having you use star maps and figuring out the faintest star visible, or using a specially-designed light meter to measure the sky's brightness. A third way is to photograph the sky and use the image data to calculate a sky brightness.

The goal of the Night Sky Light Pollution project is to test out a photographic method for measuring sky brightness and light pollution using ordinary smartphones. Here's how to participate in this research and take some spectacular photos of the starry night sky...while it lasts!



Figure 183. An example of a photo taken with a **Samsung Galaxy S9** of the Cygnus-Lyra starfield showing the hazy background light of suburban light pollution.

Observations should be taken on a clear night when the Moon is not up and when the Sun has set for at least an hour. Use an app such as *Planets* (by Dana Peters) to find Orion (winter), Scorpius (summer) or The Big Dipper (anytime) in the sky. If you can see another constellation such as Ursa Major (The Big Dipper) more easily make a note of its name.

Step 1 - Set your camera to ISO 800 and an exposure time of 1 second.

Step 2 - Point your smartphone in the direction of the constellation you selected and use your 'camera' app to take a photo.

Step 3 - Open your photo in your camera app and check that it shows as many stars as you can see with your naked eye.

Step 4 - Adjust the ISO value manually and take another photo until your photo matches what you can see.

Step 5- Tap the camera symbol and select 'Upload from camera roll' then find your image and tap it to upload.

Step 6 - Fill in the information about the Exposure time and ISO speed, and click on the appropriate check boxes.

Step 7 - Tap 'save' on the upper-right corner of the data page to upload your observation.

Recommended Settings: When you are finished with the steps above, use a 10 second exposure with a tripod to take some really lovely star field pictures showing fainter stars and upload these pictures too!

18.4 Satellite Streak Watcher

URL <https://scistarter.org/satellite-streak-watcher>

In the coming years, thousands of satellites will be deployed into low Earth orbit as part of the new internet mega-constellations. In the three hours after sunset and before sunrise, these bright streaks from reflected sunlight will crisscross the night sky and wreak havoc with astronomers trying to photograph astronomical objects from the ground. It will also be a problem for amateur astronomers for the same reasons.



Figure 184. A satellite streak photographed with a **Galaxy S9** phone at ISO 800 and 10 seconds.

This project will record for posterity the growth of this problem over many years as participants use their smartphones to photograph the increase in these streaks over time from locations around the world. These satellites will be bright enough due to sun glint to appear with magnitudes between +2 and +6m, and so can be readily photographed using most smartphone cameras. At the speed of the satellites, they will streak across the sky from horizon to horizon in about 1 degree per second, so in 10 seconds they will travel 20 times the diameter of the full moon across the sky. To photograph this event here's what you need to do.

Step 1 - Attach your smartphone to a tripod using an inexpensive bracket.

Step 2 - On an evening before your shoot, set your native camera app at >10 seconds, and ISO > 800, or use a second-party app

Step 3 - Adjust the settings to get the best star pictures and lowest sky brightness.

Step 4 - Go to Heavens-Above.com and click on 'Satellite database' which predicts satellite transit events and provides a sky map.

Step 5 - Follow the Heavens-Above directions to find the next time a satellite will pass across your ICal sky.

Step 6 - In the minutes just before the event is predicted to start, take a few test photos.

Step 7 - At the predicted start of the event, begin taking your sequence of photos until the event ends.

Step 8 - Upload the best of the photos you took and don't forget to indicate the name of the constellation being 'streaked' in your photo!

Step 9 - Make as many of these observations during the year as you can!

<https://astronomy.com/news/2020/03/nasa-needs-you-to-photograph-starlink-satellites-with-your-smartphone>

This is why I started this citizen science project, which you can see described in detail in this Discovery magazine news brief. <https://www.discovermagazine.com/the-sciences/nasa-wants-you-to-photograph-starlink-satellites-with-your-smartphone>

I would like to document the changes in the sky that will take place with the launch of these and other mega-constellation satellites into LEO. My project on Anecdota called Satellite Streak Watcher.

19.0 Joining a Community

19.1 Facebook Groups

- **Smartphone Astronomy** - Julie Straayer (Admin) and Bruce Lamberton (Admin) – The purpose of this group is to promote awareness of using the camera in your smartphone to capture high quality astronomy photos - with or without using a telescope - and to share this knowledge and techniques for doing so with others. - Currently 3,869 members.
- **Smartphone Astroimaging for Beginners** - Matthijs Burgmeijer and Scott Deringer Administrators. Please feel free to post your Astro images, whether they be the moon, stars, nebulas, planets, sunrises, and sunsets or suspected anomalies etc. I've created this site for members to submit their Smartphone images and to assist the best way to get the best out of your devices. Currently 1,642 members (March, 2020)
- **Beginner Astrophotography** - Kathy Petrucci and Liz Robertson (Admins) - A group for Astrophotographers to discuss the hobby and share their images. Focused on assisting beginners, Astrophotographers of all skill levels are welcome! - Currently 785 members
- **Astrophotography for Intermediates** - Marty Strutz and Karen Maree (Admins) - Astrophotography related content for those of us who aren't quite beginners anymore but definitely not an expert. A place to ask questions, share knowledge and not be judged based on level of skills or abilities. If you're a beginner you're more than welcome to browse, like, comment and learn but please also join Astrophotography for Beginners or similar groups as it may have a lot more to offer you when just starting out. - Currently 2,785 members.

- **Single Exposure Astrophotography** - Joye Colbeck and Jason Colbeck (Admins) - Single exposure astrophotography is a real challenge, working with just the data from one shutter release means learning how your kit really works so you can get the best from it on the night. It also means learning processing skills to bring the data you want to keep to the fore and minimizing the noise and extraneous light pollution. - Currently 5,238 members
- **Budget Astrophotography** - Leinad Abrasax and Chuck Barnett (Admins) - An Astrophotography group for the astrophotographer on a budget. If you're imaging with a DSLR, cellphone, low end CCD, and / or a low budget telescope, we want to see your images. Astrophotographers of all skill level are welcome. Even if you don't have a telescope this is still the right place. All astrophotography requires is a camera and a night sky. Nothing else. In order to keep this a budget group, we have a limit set for images posted here to be taken with no more than 3,000 USD worth of equipment. Currently 6,961 members.
- **DSLR Astronomy Images** - Steven Miller and Nigel Gilchrist (Admins) - This group is to allow those with DSLR cameras Modified and Unmodified to share and discuss their images. Currently 2,337 members.

19.2 Other Groups

The Astronomical League - This is an organization of over 500 amateur astronomy clubs in the United States. These clubs often have members involved in astrophotography. <https://www.astroleague.org/>

Astrophotography - Find out what's happening in Astrophotography Meetup groups around the world and start meeting up with the ones near you. Current members, 76,298. <https://www.meetup.com/topics/astrophotography/>

Fstoppers - Your best shots of the night sky, can be anything from stars scapes to close up images of nebula through expensive telescopes. Current members 40. <https://fstoppers.com/groups/12030/astrophotography>

Flickr Astrophotography - The astronomical objects must be the primary focus objects and should what occupies the majority of the photography. Currently 15,011 members.

Sky and Telescope Astronomy Club index - Find clubs near you that likely have members interested in astrophotography. <https://skyandtelescope.org/astronomy-clubs-organizations/>

Library Telescope Program - Your local library may have a small 4.5-inch telescope that you can check out and use for astrophotography. Many clubs have loaner scopes for their members. The New Hampshire Astronomical Society (nhastro.com), led by its member Marc Stowbridge, takes a slightly different path by developing a “Library Loaner Scope” program where low cost, quality telescopes can be checked out by library patrons in the same manner as they do books. The NHAS selects a modified Orion StarBlast 4.5-inch Dobsonian reflector as their telescope of choice. This thirteen-pound instrument is easy to use, is very portable, and comes with quality optics. Novice observers can easily obtain their first views of the moon and its craters, Jupiter and its Galilean satellites, and Saturn and its rings. The brighter deep sky objects can be seen, as well. To help prevent unauthorized fingers from meddling with the optical collimation, access to the primary mirror is physically restricted. A Celestron 8 mm - 24 mm zoom eyepiece is semi-permanently installed to prevent the inevitable loss of removable eyepieces. Full zoom (60x) splits the Trapezium stars in the Orion Nebula, while the lowest power (20x) and widest field (2°) captures the entire nebula. The biggest problem encountered is its success. With a one or two week check out period, the waiting period can grow quickly to three months!
<https://www.librarytelescope.org/>

20.0 Useful Tables

20.1 The Messier Catalog

Table 4 is a list of 110 objects catalogued by the French astronomer Charles Messier in his *Catalogue des Nébuleuses et des Amas d'Étoiles* ("Catalogue of Nebulae and Star Clusters"). Because Messier was only interested in finding comets, he created a list of non-comet objects that frustrated his hunt for them. The compilation of this list, in collaboration with his assistant Pierre Méchain, is known as the Messier catalogue. A preliminary version first appeared in the Memoirs of the French Academy of Sciences in 1771.

Since these objects could be observed visually with the relatively small-aperture refracting telescope (approximately 100 mm, or 4 inches) used by Messier to study the sky, they are among the brightest and thus most attractive ‘deep sky objects’ observable from Earth, and are popular targets for visual study and astrophotography available to modern amateur astronomers using larger aperture equipment. In early spring, astronomers sometimes gather for "Messier Marathons", when all of the objects can be viewed over a single night.

Table 4 Catalog of Messier Objects

M	NGC	Type	Con	RA	Dec.	Mag.	Size arcmin	Distance (ly)	Common Name
1	1952	N	Tau	5h 34.5m	+22° 01'	8.4	6x4	6300	Crab Nebula
2	7089	C	Aqr	21h 33.5m	+00° 49'	6.5	12.9	37900	
3	5272	C	CVn	13h 42.2m	+28° 23'	6.2	16.2	33900	
4	6121	C	Sco	16h 23.6m	-26° 32'	5.6	26.3	7200	
5	5904	C	Ser	15h 18.6m	+02° 05'	5.6	17.4	24500	
6	6405	C	Sco	17h 40.1m	-32° 13'	4.2	25	1600	Butterfly Cluster
7	6475	C	Sco	17h 53.9m	-34° 49'	3.3	80	800	Ptolemy's Cluster
8	6523	N	Sgr	18h 03.8m	-24° 23'	6.0	90x40	5200	Lagoon Nebula
9	6333	C	Oph	17h 19.2m	-18° 31'	7.7	9.3	26700	
10	6254	C	Oph	16h 57.1m	-04° 06'	6.6	15.1	14400	
11	6705	C	Sct	18h 51.1m	-06° 16'	6.3	14	6000	Wild Duck Cluster
12	6218	C	Oph	16h 47.2m	-01° 57'	6.7	14.5	16000	
13	6205	C	Her	16h 41.7m	+36° 28'	5.8	16.6	25100	Hercules Globular
14	6402	C	Oph	17h 37.6m	-03° 15'	7.6	11.7	29000	
15	7078	C	Peg	21h 30m	+12° 10'	6.2	12.3	33600	Pegasus Globular
16	6611	C	Ser	18h 18.8m	-13° 47'	6.4	7	7000	Eagle Nebula
17	6618	N	Sgr	18h 20.8m	-16° 11'	7.0	11	5000	Omega Nebula
18	6613	C	Sgr	18h 19.9m	-17° 08'	7.5	9	4900	
19	6273	C	Oph	17h 02.6m	-26° 16'	6.8	13.5	28400	
20	6514	N	Sgr	18h 02.6m	-23° 02'	9.0	28	5200	Trifid Nebula
21	6531	C	Sgr	18h 04.6m	-22° 30'	6.5	13	4250	
22	6656	C	Sgr	18h 36.4m	-23° 54'	5.1	24	10400	Sagittarius Cluster
23	6494	C	Sgr	17h 56.8m	-19° 01'	6.9	27	2150	
24	-	MW	Sgr	18h 16.9m	-18° 30'	4.6	90	10000	Sagittarius Star Cloud
25	IC4725	C	Sgr	18h 31.6m	-19° 15'	6.5	40	2000	
26	6694	C	Sct	18h 45.2m	-09° 24'	8.0	15	5000	
27	6853	N	Vul	19h 59.6m	+22° 43'	7.4	8.0x5.7	1250	Dumbbell Nebula
28	6626	C	Sgr	18h 24.5m	-24° 52'	6.8	11.2	18600	
29	6913	C	Cyg	20h 23.9m	+38° 32'	7.1	7	4000	
30	7099	C	Cap	21h 40.4m	-23° 11'	7.2	11	26100	
31	224	G	And	0h 41.8m	+41° 16'	3.4	178x63	3 million	Andromeda Galaxy
32	221	G	And	0h 42.8m	+40° 52'	8.1	8x6	3 million	
33	598	G	Tri	1h 33.9m	+30° 39'	5.7	73x45	3 million	Triangulum Galaxy
34	1039	C	Per	2h 42m	+42° 47'	5.5	35	1400	
35	2168	C	Gem	6h 08.9m	+24° 20'	5.3	28	2800	
36	1960	C	Aur	5h 36.1m	+34° 08'	6.3	12	4100	

37	2099	C	Aur	5h 52.4m	+32° 33'	6.2	24	4400	
38	1912	C	Aur	5h 28.7m	+35° 50'	7.4	21	4200	
39	7092	C	Cyg	21h 32.2m	+48° 26'	4.6	32	825	
40	Win4	N	UMa	12h 22.4m	+58° 05'	8.4	0.8	510	Winnecke 4
41	2287	C	CMa	6h 47m	-20° 44'	4.6	38	2300	
42	1976	N	Ori	5h 35.4m	-05° 27'	4.0	85x60	1600	Nebula in Orion
43	1982	N	Ori	5h 35.6m	-05° 16'	9.0	20x15	1600	De Mairan's Nebula
44	2632	C	Cnc	8h 40.1m	+19° 59'	3.7	95	577	Beehive Cluster
45	-	C	Tau	3h 47m	+24° 07'	1.6	110	380	Pleiades
46	2437	C	Pup	7h 41.8m	-14° 49'	6.0	27	5400	
47	2422	C	Pup	7h 36.6m	-14° 30'	5.2	30	1600	
48	2548	C	Hya	8h 13.8m	-05° 48'	5.5	54	1500	
49	4472	G	Vir	12h 29.8m	+08° 00'	8.4	9x7.5	60 million	
50	2323	C	Mon	7h 03.2m	-08° 20'	6.3	16	3000	
51	5194	G	CVn	13h 30m	+47° 11'	8.4	11x7	37 million	Whirlpool Galaxy
52	7654	C	Cas	23h 24.2m	+61° 35'	7.3	13	5000	
53	5024	C	Com	13h 12.9m	+18° 10'	7.6	12.6	59700	
54	6715	C	Sgr	18h 55.1m	-30° 29'	7.6	9.1	88700	
55	6809	C	Sgr	19h 40m	-30° 58'	6.3	19	17600	
56	6779	C	Lyr	19h 16.6m	+30° 11'	8.3	7.1	32900	
57	6720	N	Lyr	18h 53.6m	+33° 02'	8.8	1.4x1.0	2300	Ring Nebula
58	4579	G	Vir	12h 37.7m	+11° 49'	9.7	5.5x4.5	60 million	
59	4621	G	Vir	12h 42m	+11° 39'	9.6	5x3.5	60 million	
60	4649	G	Vir	12h 43.7m	+11° 33'	8.8	7x6	60 million	
61	4303	G	Vir	12h 21.9m	+04° 28'	9.7	6x5.5	60 million	
62	6266	C	Oph	17h 01.2m	-30° 07'	6.5	14.1	22500	
63	5055	G	CVn	13h 15.8m	+42° 02'	8.6	10x6	37 million	Sunflower Galaxy
64	4826	G	Com	12h 56.7m	+21° 41'	8.5	9.3x5.4	19 million	Black Eye Galaxy
65	3623	G	Leo	11h 18.9m	+13° 05'	9.3	8x1.5	35 million	
66	3627	G	Leo	11h 20.2m	+12° 59'	8.9	8x2.5	35 million	
67	2682	C	Cnc	8h 50.4m	+11° 49'	6.1	30	2700	
68	4590	C	Hya	12h 39.5m	-26° 45'	7.8	12	33300	
69	6637	C	Sgr	18h 31.4m	-32° 21'	7.6	7.1	28000	
70	6681	C	Sgr	18h 43.2m	-32° 18'	7.9	7.8	29400	
71	6838	C	Sge	19h 53.8m	+18° 47'	8.2	7.2	12700	
72	6981	C	Aqr	20h 53.5m	-12° 32'	9.3	5.9	55400	
73	6994	C	Aqr	20h 59m	-12° 38'	9.0	2.8	2000	
74	628	G	Psc	1h 36.7m	+15° 47'	9.4	10.2x9.5	35 million	
75	6864	C	Sgr	20h 06.1m	-21° 55'	8.5	6	61300	

76	650	N	Per	1h 42.4m	+51° 34'	10.1	2.7x1.8	3400	Dumbbell Nebula
77	1068	G	Cet	2h 42.7m	+00° 02'	8.9	7x6	60 million	
78	2068	N	Ori	5h 46.7m	+00° 03'	8.3	8x6	1600	
79	1904	C	Lep	5h 24.5m	-24° 33'	7.7	8.7	42100	
80	6093	C	Sco	16h 17m	-22° 59'	7.3	8.9	32600	
81	3031	G	UMa	9h 55.6m	+69° 04'	6.9	21x10	12 million	Bode's Galaxy
82	3034	G	UMa	9h 55.8m	+69° 41'	8.4	9x4	12 million	Cigar Galaxy
83	5236	G	Hya	13h 37m	-29° 52'	7.6	11x10	15 million	Southern Pinwheel
84	4374	G	Vir	12h 25.1m	+12° 53'	9.1	5	60 million	
85	4382	G	Com	12h 25.5m	+18° 12'	9.1	7.1x5.2	60 million	
86	4406	G	Vir	12h 26.2m	+12° 57'	8.9	7.5x5.5	60 million	
87	4486	G	Vir	12h 30.8m	+12° 24'	8.6	7	60 million	
88	4501	G	Com	12h 32.1m	+14° 26'	9.6	7x4	60 million	
89	4552	G	Vir	12h 35.7m	+12° 33'	9.8	4	60 million	
90	4569	G	Vir	12h 36.8m	+13° 10'	9.5	9.5x4.5	60 million	
91	4548	G	Com	12h 35.5m	+14° 30'	10.2	5.4x4.4	60 million	
92	6341	C	Her	17h 17.1m	+43° 08'	6.4	11.2	26700	
93	2447	C	Pup	7h 44.6m	-23° 52'	6.0	22	3600	
94	4736	G	CVn	12h 50.9m	+41° 08'	8.2	7x3	15 million	
95	3351	G	Leo	10h 44m	+11° 42'	9.7	4.4x3.3	38 million	
96	3368	G	Leo	10h 46.8m	+11° 49'	9.2	6x4	38 million	
97	3587	N	UMa	11h 14.8m	+55° 01'	9.9	3.4x3.3	2600	Owl Nebula
98	4192	G	Com	12h 13.9m	+14° 55'	10.1	9.5x3.2	60 million	
99	4254	G	Com	12h 18.9m	+14° 26'	9.9	5.4x4.8	60 million	
100	4321	G	Com	12h 23m	+15° 50'	9.3	7x6	60 million	
101	5457	G	UMa	14h 03.2m	+54° 21'	7.9	22	27 million	Pinwheel Galaxy
102	5866	G	Dra	15h 06.5m	+55° 46'	9.9	5.2x2.3	40 million	
103	581	C	Cas	1h 33.2m	+60° 42'	7.4	6	8500	
104	4594	G	Vir	12h 40m	-11° 37'	8.0	9x4	50 million	Sombrero Galaxy
105	3379	G	Leo	10h 47.8m	+12° 35'	9.3	2	38 million	
106	4258	G	CVn	12h 18.9m	+47° 19'	8.4	19x8	25 million	
107	6171	C	Oph	16h 32.5m	-13° 03'	7.9	10	20900	
108	3556	G	UMa	11h 11.5m	+55° 40'	10.0	8x1	45 million	
109	3992	G	UMa	11h 57.6m	+53° 23'	9.8	7x4	55 million	
110	205	G	And	00h 40.4m	+41° 41'	8.5	17x10	3 million	

20.2 Table of Solar Eclipses

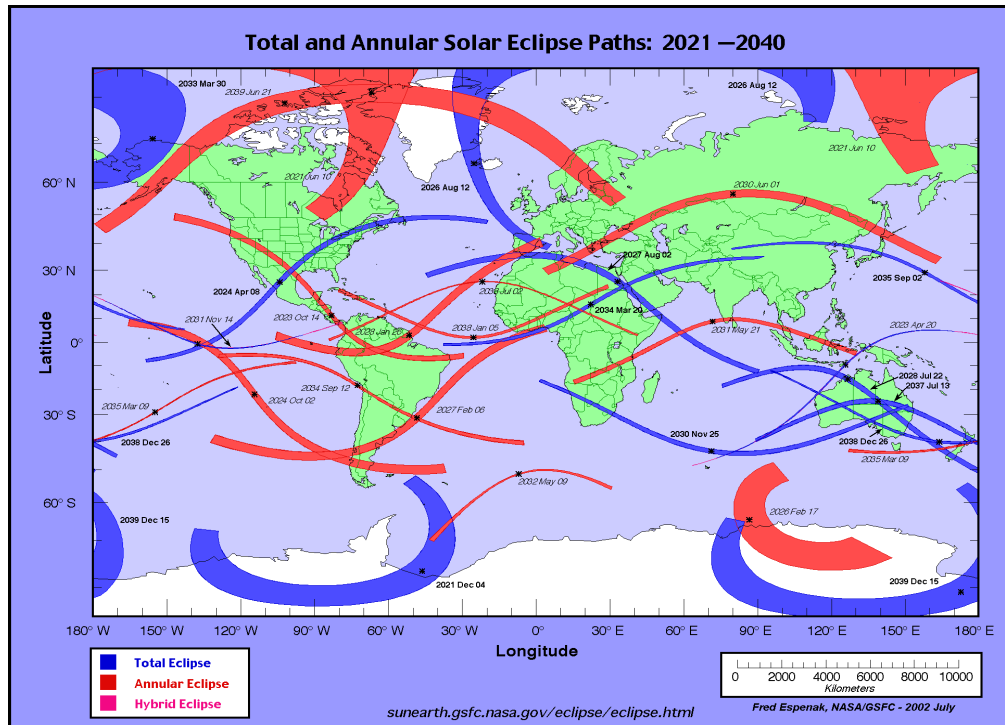

Figure 185. A map of total, annular and hybrid solar eclipses coming up from 2021 to 2040. (Credit Fred Espenak/NASA/GSFC)

Table 5 Solar Eclipses from 2021 to 2030

Date	Type	Duration	Visibility
June 10, 2021	Annular	3m 51s	N. America, Europe, Asia
December 4, 2021	Total	1m 54s	Antarctica, S. Atlantic
April 30, 2022	Partial		Pacific, S. America
October 25, 2022	Partial		Europe, Mideast
April 20, 2023	Hybrid	1m 16s	Asia, Australia, Philippines
October 14, 2023	Annular	5m 17s	N. America, S. America
April 8, 2024	Total	4m 28s	N. America, C. America
October 2, 2024	Annular	7m 25s	Pacific, S. America
March 29, 2025	Partial		Africa, Europe
September 21, 2025	Partial		Antarctica, New Zealand
February 17, 2026	Annular	2m 20s	Antarctica, Argentina, Chile
August 12, 2026	Total	2m 18s	N. America, Africa, Europe
February 6, 2027	Annular	7m 51s	Antarctica, S. America

20.3 Table of Lunar Eclipses

Table 6 Lunar eclipses from 2021 to 2028

Date	Type	Duration	Visibility
May 26, 2021	Total	3h 7m	Australia, Pacific, Americas
November 19, 2021	Partial	3h 28m	Americas, Australia, Pacific
May 16, 2022	Total	3h 27m	Americas, Europe, Africa
November 8, 2022	Total	3h 40m	Australia, Pacific, Americas
May 5, 2023	Penumbral		Africa, Asia, Australia
October 28, 2023	Partial	1h 17m	Americas, Europe, Australia
March 25, 2024	Penumbral		Americas
September 18, 2024	Partial	1h 3m	Americas, Europe, Africa
March 14, 2025	Total	3h 38m	Pacific, Americas, Africa
September 7, 2025	Total	3h 29m	Europe, Africa, Australia
March 3, 2026	Total	3h 27m	Americas, Australia, Pacific
August 28, 2026	Partial	3h 18m	Americas, Pacific, Africa
February 20, 2027	Penumbral		Americas, Europe
July 18, 2027	Penumbral		Pacific, Australia
August 17, 2027	Penumbral		Americas, Pacific
January 12, 2028	Partial	0h 56m	Americas, Europe, Africa

Table credit Fred Espenak. <https://eclipse.gsfc.nasa.gov/LEdecade/LEdecade2021.html>

20.4 Interesting Planetary Appulses and Conjunctions

Table 7 Close Planetary Appulses and Conjunctions

Event Date	Planets	Description
March 5, 2021	Jupiter - Mercury	Separation 19 arcminutes
July 13, 2021	Venus-Mars	Separation 28 arcminutes
March 2, 2022	Mercury-Saturn	Separation 40 arcminutes
March 16, 2022	Venus - Mars	Separation 3.9 degrees
March 29, 2022	Venus - Saturn	Separation 2.1 degrees
April 5, 2022	Mars Saturn	Separation 18 arcminutes
April 27, 2022	Venus - Neptune	Separation 0 arcminutes
April 30, 2022	Venus - Jupiter	Separation 13 arcminutes
May 29, 2022	Mars - Jupiter	Separation 34 arcminutes

Note: From <https://in-the-sky.org/article.php?term=appulse&year=2022#table>

21.0 List of contributors for figures

Viktor Abelin 84, 105, 106
Joe Adlhoch 114
Walter Apollonio 151
Michael Armentrout 71,76
Barel Azimtai 81
Geoffrey Baker 35, 56
Loren Ball 88, 92, 122
Chris Barkley 138
Deborah Bonser 135
Jim Bonser 135
Christian Buil 128
Matthijs Burgmeijer 91, 99, 143
Thomas-Juliana Campbell 104, 143
Jeff Charles 130
Gabriel Clark 61 and **BC**
Roger Clark 22
Spencer Collins 73, **FC**
David Cortner 133
Elizabeth Crossman 14
Stuart Davis 88
Scott Dearing 77, 92
Jean-Marie Delaporte 141
Peter Deller 97
Tim Dillon 123
Michael Dooley 90
Luis Delgado Gallardo 58, 59, 64
Paul Gibbs 85
Rory Griffin 44
Robert Grögler 139
Stefan Gruber 95
Christian Harris 57, 83, 116, 121, 161, **FC**
Patrick Heys 152
Billy Heather 124, 160, **FC**
Drew Henry 77
Robert Hite 102
Zach Honig 159
Joey Hunter 103
Ashley Irons 107
Grainge Jennings 96
Justine Claire Jones 120
Christopher Jones 115, **FC**
Mark Johnson 108
Stacey Jones 75, 78
Florian Kainz 34, 37
Stanislov Kaniansky 149, **FC**
Bhushan Karmarkar 76, 181
Tony Karp 126
Jussi Laasonen 43
Ferdinand Labra 114
Nerida Langcake 102, 119, 148
Drew Langford 36
Rocco Lico 125
Oscar Lithgow 92
Andrew Lomax 137
Elisabeth Macdonald 162, **FC**
Jason Melquist 27
Michael Murphy 117
Logan Nicholson 93, 100
Clive Nicholson 147
Donald Noor 65, 136, 148, **FC**
Daryl Olszski 53
Mir Oslov 113
Alexander Parmington 90
Christine Phares 84
Jim Preusse 82
Marius Reitz 89
Giovanni Fabio Salerno 60
Elad Schwartz 107
Doug Shelley 97
Mathew Shields 62
Guy Shimon 70, 81, 87
Claus Sorenson 163
Keith Stanley `144
Julie Straayer 130
Jason Stromback 89, 90
Luke Smith 85, 159
Wilfred Susaya 75
John Taylor 29, 55, 80, 86
Dave Trott 19
Tom Urbain 150
Chris Vaughn 111
Andrew Vieira 79
Michael Seeboeger-Weichselbaum 98, 118, 131, **FC**
Armand Wiersema 78
Rob Wood 4, 72
Sean Wood 74
Chris Woodcock 68, 132
Shun-Chia Yang 30, **FC**
FC=Front cover art
BC=Back cover art

22.0 Glossary of Terms

Aperture – The optical element (mirror or lens) through which light passes on its way to the eyepiece, photographic film or array. Between the aperture and the sensor there can be a number of other optical elements such as mirrors or focusing lenses.

Appulse – An astronomical arrangement in the sky viewed from Earth where the planets appear at their minimum separation from one another or from another object such as a galaxy, star cluster or nebula.

Arcminute – A unit of angular measure equal to 1/60 of a degree. A related angular measure is the arcsecond (asec) which is 1/60 of an arcminute.

Bayer mask – This is a collection of red-green-blue filters in a 2x2 arrangement that sits in front of the camera image sensor. The camera array is now composed of 4 RGB images for each camera image pixel, and from this a color image can be reconstructed from a single image. The 2x2 filter arrangement is called a Bayer mask.

Bias frame – The electronic components in a digital camera often produce different voltage offsets to the pixels in an array. If you take an image with the camera lens covered at the shortest possible exposure, these pixel-to-pixel variations will appear and can be subtracted from the final image.

Broadband filter – An optical device that permits a wide range of electromagnetic wavelengths to pass through. These are often named after the part of the visible spectrum of light that they pass such as a yellow filter, a green filter or a blue filter. Typically, the range spans about 50 to 100 nanometers, unlike Narrow-band filters that pass very narrow ranges such as 1-5 nanometers or less.

Coadding – The mathematical process of combining two or more images after registering them so that corresponding pixels are centered. The pixel values are added together at each pixel to create a summed image.

Collimation- The process of making sure that the optical axis of each lens or mirror is aligned along a single main axis for the entire instrument.

CMOS sensor - A type of circuit design in which the electronics needed for the sensor are built into the sensor chip.

Dark current – A flow of electrons produced by thermal agitation that leak into each sensor pixel where they can mimic the detection of photons by the camera sensor.

Dark frame – An exposure produced by blanking off the array (covering the camera lens) and exposing the array for the same amount of time as the time used for the astronomical image. The resulting ‘dark counts’ in each pixel are then subtracted from the image to correct for this effect.

Declination – One of the two coordinates used to identify the location of an astronomical object, which corresponds to latitude on the surface of earth.

Digital noise – Random or nearly-random variations in the measured output from a pixel caused by either the electrical circuit or by the random arrival of photons, although the latter is more properly called photon noise.

Diurnal – This refers to a movement of the sky caused solely by the rotation of Earth around its axis.

Dobsonian – An inexpensive reflecting telescope design that resembles a Newtonian reflector but where the main mirror is suspended in a sling at the bottom of the telescope tube rather than attached to a mirror mount. Usually designed with a simple alt-az mounting to avoid the telescope tube being tipped over too far, which would cause the mirror to fall out.

Dynamic range – This is a measure of the difference between the faintest and brightest object that can be photographed without saturating the image.

DSO – Abbreviation for deep sky object, which is generally any astronomical object that is very distant and visually faint such as a galaxy, a planetary nebula or a globular star cluster.

DSLR – The abbreviation for Digital Single-Lens Reflex, which operates like an ordinary SLR except that instead of using photographic film it uses a digital sensor array to capture the image.

Flat field – When a camera takes a picture of a uniformly illuminated surface, the image should show a constant intensity from pixel-to-pixel. Usually individual pixels have different gains which means some may generate more electrons and others less for the same number of arriving photons. An image of a uniform source will show this variation, and can be used to correct the final image by correcting each pixel to the same uniform gain across the entire array.

Gaussian – Also a ‘Gaussian distribution’ is a statement about a series of measurements that indicates that collectively they form a Bell Curve and can be characterized by a mean and a standard deviation. Also, the standard deviation or measurement uncertainty follows the Root-N law such that when you average N measurements the standard deviation of the average will be reduced by \sqrt{N} .

Goto – A type of telescope that is computer-controlled and can target an astronomical objects by entering its name into the interface. The telescope then slews to the location automatically.

H-Alpha- Also written as Ha, is a spectral line produced by the hydrogen atom at a wavelength of 656.3 nanometers. It is a very bright line found in most stars and other hydrogen-rich systems heated to temperatures above 3,000 C.

Illuminance – A measure of the amount of light falling on a specific surface in units of Lux (lx). Illuminance depends on how the surface is oriented and also the elevation of the light source above the plane of the surface. The illuminance of the sun in the winter is lower than in the summer due to the height of the sun above the horizon.

ISO – This is a term used to indicate the speed of the sensor and roughly corresponds to quantum efficiency.

Micron – A unit of measurement equal to one-millionth of a meter or 0.00004 inches.

Native camera – All modern smartphones come with their own camera systems. These are operated by accessing an app which is often called the Native camera app because it came with the phone. Usually they are simple with little functionality because they tend to be fully-automatic. To get more features you often need to get a Third-Party camera app from your Apple or Google store.

Optical zoom – This is the feature of a camera lens that allows you to magnify the scene by moving the lens to different focal lengths. This is why telephoto lenses are often barrel-shaped. Smartphones generally have fixed lenses so their optical zoom is also fixed. However, you can create Digital Zoom by using an app that lets you capture only a small number of the pixels in your camera's field-of-view. For example, if you took a 1000x1000 image of a scene but only enlarged the central 100x100 pixels you would get a digital zoom of 10x but of course you would also start to see the individual pixels!

Parhelia – These are sunlight phenomena produced when sunlight passes through ice crystals and get redirected to the eye of the observer forming arcs and other atmospheric light features common in Arctic regions.

Photons – These are the elementary particles from which light is formed and that carry no mass, travel at the speed of light and carry an amount of energy given by Planck's Law $E = hn$ where n is the frequency of light and $h = 6.62 \times 10^{-32}$ joule-seconds.

Photodiode – This is a semiconductor device that consists of two different materials in contact with each other to form a junction. When light (photons) fall upon the junction, a small current of electrons will flow one way through the junction. Each pixel in a smartphone camera consists of one of these photodiodes. The current they produce is proportional to how much light falls on their piece of the image.

Pixel – An elementary element of an image that usually corresponds to the boundaries of a light-sensitive device such as a photodiode.

Quantum efficiency – The ratio of the number of electrons produced by a photon that falls on the device. A quantum efficiency of 0.5 means that if two photons fall on a device only one photon is registered and detected.

Saturation – When the amount of light falling on a photographic surface or a camera array causes all of the elements of the material to be activated, the medium is said to be saturated. For photographic film based on grains of silver in an emulsion, all of the grains will be active causing the film to turn white. For arrays, each pixel can only be filled by a set number of electrons. If enough photons strike the pixel the well will completely fill up with electrons.

Scintillation – This is a condition in the atmosphere where the optical paths change rapidly due to turbulence and cause the image of a star or other small astronomical object to twinkle.

Solar granulation – These are large plasma systems on the surface of the sun often 1,000 km across, which come and go in matters of a few hours or less.

SLR – abbreviation for Single-Lens Reflex, which is a camera that uses a movable mirror on the axis of the camera lens that lets you see through the lens to set up your exposure. The ‘reflex’ mirror moves out of the way when you start the exposure.

Stacking – This is a digital photographic technique that involves aligning the individual images so that corresponding pixels are located vertically in a stack. The next step is usually to average the pixel values along each stacked column of image arrays.

Totality – A term used to describe the moment when a total solar eclipse commences with the moon fully in front of the sun.

Twilight – A condition of low light that begins just after sunset and continues until the first stars become visible usually after about 45 minutes.

Well capacity – If you think of the sensor array forming a digital image as a set of buckets arranged in rows and columns, the capacity of each pixel is determined by the number of electrons it can store before it is read out. There is a maximum number of electrons that can be stored. When photons arrive during an exposure, they create electrons in the wells, but if the light is too intense during the exposure, the buckets will fill up and become saturated.

23.0 Index of Smartphones

Galaxy S4 110

Galaxy Note 5 112

Galaxy S6 118

Galaxy S7 112
Galaxy S7 Edge 54
Galaxy S8 64, 89, 101, 116, 117, 137
Galaxy S20 Ultra 69
Galaxy Note 8 92, 150
Galaxy S9 22,26,35,41,51,52,53,64,75,79, 82, 83, 88, 103, 104, 117, 122, 133, 155, 156
Galaxy S10 41, 101
Galaxy Note +10 45, 65, 70, 77, 81, 85
Galaxy S20 Ultra 128
Google Pixel 16
Google Pixel 3XL 36, 65, 85, 86, 89, 105
Google Pixel 4XL 41
Google Pixel 4 45, 46, 89, 148
Hauwei 3a 93
Hauwei 30p 26, 41, 97, 105, 119, 138, 151
Hauwei 20p 73, 93, 96, 99, 127, 129, 137, 139
HTC U 37, 54
iPhone 5s 41, 74, 123
iPhone 6s 16, 41, 51, 59, 61, 62, 63, 64, 74, 112, 113
iPhone 7 63, 76, 82, 85, 91, 92, 94, 97, 114, 134
iPhone 11 Pro 11, 41, 44, 78, 88, 92, 106, 122, 128, 148
iPhone SE 92
iPhone XR 94
iPhone XS 22, 79, 82, 97
LG G8 66, 140

LG G4 137
LG G5 67, 73, 113, 149
LG Q7 82
LG Q7 ThinQ 87, 116
LG V20 102, 133
LG V30 41, 94, 101
Nokia 8 41
OnePlus 5T 68
OnePlus 6 44
OnePlus 7T Pro 26, 41
Xiaomi Pocophone F1 98, 115, 123
Xiaomi Redmi 3s Prime 81
Xiaomi Redmi Note 7 Pro 22
Xiaomi Redmi Note 8 41

24.0 References

Anandtech.com, <https://www.anandtech.com/show/10753/the-google-pixel-xl-review/4>

Bryce Rose - Analysis of light pollution influence on sky quality in Istria a.k.a.: The “glow in the dark” group Mirna Kramar, Petra Korlević, Željko Andreić-
<https://slideplayer.com/slide/7258224/>

Canon Corp, Dpreview.com, <https://www.dpreview.com/articles/5428715929/canon-announces-production-of-90-millionth-ef-lens>

CameraFV5, https://www.camerafv5.com/tutorials/camera_manual.php

Chromey and Hasselbacher, 1996; <https://iopscience.iop.org/article/10.1086/133817>

Dani, T., Sulistiani, S., 2019, Prediction of maximum amplitude of solar cycle 25 using machine learning, 2019 J. Phys.: Conf. Ser. 1231 012022, <https://iopscience.iop.org/article/10.1088/1742-6596/1231/1/012022>

DeepSkyCamera, https://www.deepskycamera.de/manual/DeepSkyCamera_manual_en.pdf

DeepSkyStacker, (<http://deepskystacker.free.fr/english/index.html>)

Foust, Jeff, 2020, Starlink vs the Astronomers, <https://spacenews.com/starlink-vs-the-astronomers/>

Googleblog, <https://ai.googleblog.com/2018/11/night-sight-seeing-in-dark-on-pixel.html>

Googleblog2, <https://ai.googleblog.com/2019/11/astrophotography-with-night-sight-on.html>

Haworth, <http://www.stargazing.net/david/constel/howmanystars.html>

King, Bob, 2015, Observer's Guide to the H-Alpha Sun, <https://skyandtelescope.org/observing/guide-to-observing-the-sun-in-h-alpha092321050923/>

Koren, Marina, 2020, The Night Sky Will Never Be the Same - <https://www.theatlantic.com/science/archive/2020/02/spacex-starlink-astronomy/606169/>

Mack, Eric, 2020, SpaceX and Starlink are changing the night sky, and fast - <https://www.cnet.com/news/spacex-starlink-satellite-launches-changing-night-sky/>

Night Photography Workshop, 2020, Light Pollution Maps, <http://www.nightphotographyworkshop.com/articles-tutorials/how-to-find-dark-skies-for-night-photography>

Taylor, R. 2020, NightCap Camera App in Long Exposure Mode for Photography', <https://www.cloudynights.com/topic/693694-nightcap-long-exposure-mode-for-iphone/>, accessed March 20, 2020.

Unihedron - <http://www.unihedron.com/projects/darksky/index.php>

Wikipedia, 2020, Open Star Cluster List, https://en.wikipedia.org/wiki/List_of_open_clusters.



National Aeronautics and Space Administration

NASA Space Science Education Consortium
Goddard Space Flight Center
Greenbelt, MD 20771
<https://go.nasa.gov/2IXhsFq>