



# High Flyers Alphabet Activity Book



For kids!

## **Acknowledgments**

Thanks to the High Flyers Alphabet Activity Book team for their invaluable suggestions and fortitude to see this book come to fruition. Thanks also to the teachers who provided our team with ideas and feedback and, most important, the NASA Headquarters Aeronautics Research Mission Directorate for funding this outreach activity.

### **Team Members**

Brontie DeFreitas-Fox, Communications Support Services Center

Carol Galica, Office of Educational Programs

Kelly Ison, Subsonic Systems Office

Shanessa Jackson, Office of Educational Programs

Susan Johnson, Subsonic Systems Office

Jenay Sharp Leach, Aeronautics Research Mission Directorate Education

Marge Lehky, Office of Educational Programs

Kelly Shankland, Logistics and Technical Information Division

Linda Skrada, Subsonic Systems Office

Tony Springer, Aeronautics Research Mission Directorate Education

Renee Yoder, Office of Educational Programs

## Introduction

The National Aeronautics and Space Administration (NASA) conducts research for aeronautics, too! This High Flyers Alphabet Activity book has been created to introduce some basic aeronautics terms for children attending kindergarten through second grade. We want them to realize that many aeronautics terms and concepts surround them every day. These activities show how an alphabet letter can be related to an aeronautics concept and basic aeronautics terms. The child is invited to look at each of the letters, trace the letter, and print the letter in the space provided. We hope they enjoy doing the activities, too. Answers to the activities can be found on the last few pages of this book.

## About NASA

NASA is world-renowned for its research contributions to aircraft engines. We are world class in providing advanced technologies to U.S. industry, making engines more reliable and efficient. We partner with industry to create more economical air travel for the public, using engines that pollute less and are quiet to operate. We also pursue breakthrough technologies that will allow us, one day, to travel above the speed of sound using supersonic and hypersonic air vehicles.

Please visit our Web sites to learn more about NASA aer propulsion, aeronautics research, and outreach activities.

### **NASA**

<http://www.nasa.gov/>



### **NASA Aeronautics Research Mission Directorate**

<http://www.aeronautics.nasa.gov/>

### **NASA Aeronautics Education**

<http://www.aeronautics.nasa.gov/education.htm>



### **NASA Education for Students**

<http://www.nasa.gov/audience/forstudents/index.html>

# National Math and Science Standards

	A	B	C	D	E	F	G	H	I	J	K	L	M
<b>Mathematic Standards</b>													
Number and operations			✈		✈	✈		✈					✈
Algebra													
Geometry		✈		✈									✈
Data analysis and probability		✈	✈	✈	✈		✈	✈	✈	✈	✈		✈
Problem solving	✈	✈	✈	✈	✈	✈		✈	✈	✈	✈	✈	✈
Reasoning and proof	✈		✈			✈	✈	✈	✈	✈	✈	✈	✈
Communication													
Connections	✈	✈	✈	✈	✈	✈	✈	✈		✈	✈	✈	✈
Representation	✈	✈	✈		✈	✈		✈					✈
<b>Science Process Skills</b>													
Compare	✈	✈	✈		✈	✈		✈	✈	✈	✈	✈	✈
Describe													
Sort	✈	✈	✈		✈	✈			✈			✈	
Predict						✈					✈		
Manipulation		✈		✈			✈		✈			✈	✈
Classification						✈						✈	✈
Grouping			✈			✈		✈	✈	✈	✈		
Interpret data	✈	✈	✈	✈	✈	✈	✈	✈		✈	✈	✈	✈
Make models							✈						
Inferring	✈	✈	✈	✈		✈		✈	✈	✈	✈	✈	✈
Observing	✈	✈	✈	✈	✈	✈	✈	✈	✈	✈	✈	✈	✈
<b>Science Content Standards K-4</b>													
Physical science	✈	✈	✈	✈	✈	✈	✈		✈		✈	✈	✈
Position and motion of objects	✈	✈	✈	✈	✈	✈	✈		✈			✈	
Properties of objects/materials		✈			✈						✈	✈	✈
Unifying concepts/processes	✈	✈	✈	✈		✈	✈	✈	✈	✈		✈	✈
Evidence, models, and explanation	✈						✈	✈	✈	✈		✈	✈
Form and function	✈	✈	✈	✈		✈	✈		✈	✈		✈	✈
Earth science			✈	✈		✈					✈		
Objects in the sky		✈	✈	✈	✈							✈	
Changes in earth and sky											✈		
Science and technology	✈	✈			✈		✈		✈	✈		✈	✈
Abilities of technological design	✈	✈			✈		✈			✈			
Understand science/technology					✈				✈	✈		✈	✈
Scientific inquiry	✈	✈	✈	✈	✈	✈	✈	✈	✈	✈	✈	✈	✈

# National Math and Science Standards

	N	O	P	Q	R	S	T	U	V	W	X	Y	Z
<b>Mathematic Standards</b>													
Number and operations	✈					✈	✈					✈	✈
Algebra													
Geometry			✈			✈			✈	✈	✈		
Data analysis and probability	✈		✈	✈			✈	✈	✈	✈		✈	✈
Problem solving	✈	✈	✈	✈	✈	✈	✈	✈	✈	✈	✈	✈	✈
Reasoning and proof			✈		✈	✈	✈		✈		✈	✈	✈
Communication													
Connections	✈	✈	✈	✈	✈	✈	✈	✈	✈	✈	✈	✈	✈
Representation	✈	✈	✈	✈		✈	✈	✈	✈	✈	✈	✈	✈
<b>Science Process Skills</b>													
Compare		✈	✈	✈			✈	✈	✈	✈	✈		✈
Describe						✈			✈		✈	✈	
Sort	✈	✈	✈				✈	✈					
Predict													
Manipulation	✈		✈		✈	✈	✈	✈	✈		✈	✈	
Classification		✈											
Grouping		✈				✈		✈					✈
Interpret data	✈	✈	✈	✈	✈		✈	✈	✈	✈	✈	✈	✈
Make models						✈			✈		✈	✈	
Inferring	✈		✈	✈	✈	✈	✈	✈	✈	✈	✈	✈	✈
Observing	✈	✈	✈	✈	✈	✈	✈	✈	✈	✈	✈	✈	✈
<b>Science Content Standards K-4</b>													
Physical science			✈	✈		✈	✈	✈	✈	✈	✈		✈
Position and motion of objects		✈	✈	✈		✈	✈	✈	✈	✈	✈	✈	✈
Properties of objects/materials						✈	✈	✈					
Unifying concepts/processes	✈		✈	✈	✈	✈	✈	✈	✈	✈	✈	✈	✈
Evidence, models, and explanation	✈		✈	✈		✈			✈	✈	✈	✈	✈
Form and function	✈		✈			✈	✈	✈		✈			
Earth science						✈	✈	✈					✈
Objects in the sky					✈	✈	✈						✈
Changes in earth and sky													
Science and technology		✈	✈	✈		✈	✈	✈		✈	✈	✈	✈
Abilities of technological design			✈	✈		✈			✈	✈			
Understand science/technology			✈	✈		✈	✈	✈		✈	✈	✈	✈
Scientific inquiry	✈	✈	✈	✈	✈	✈	✈	✈	✈	✈	✈	✈	✈

Aa Aa

# aircraft

Draw a line to match each **aircraft** to its shadow.

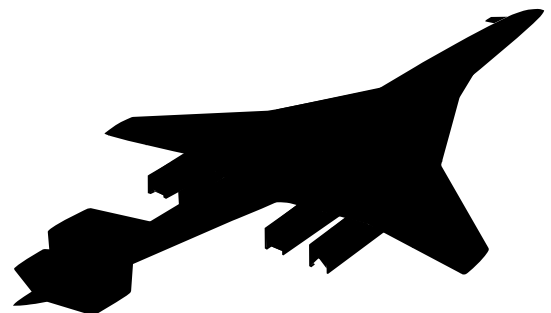
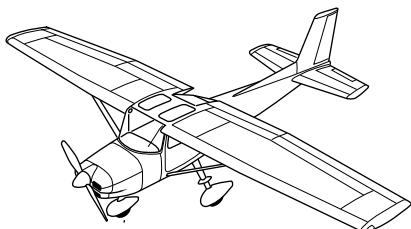
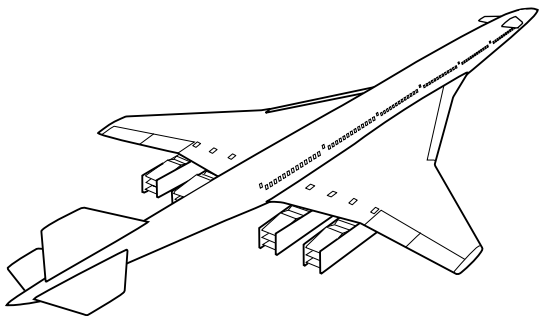
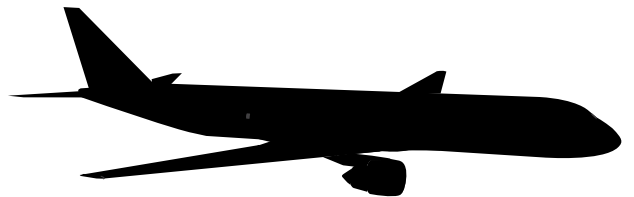
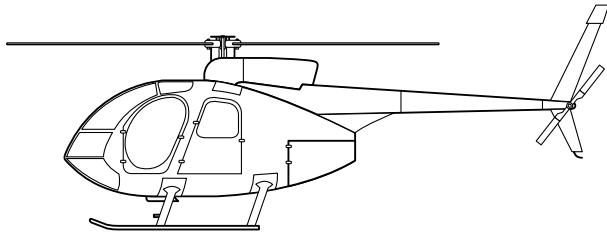
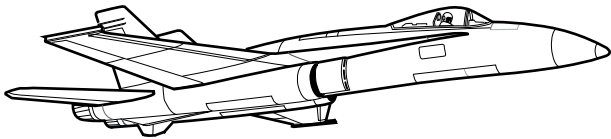
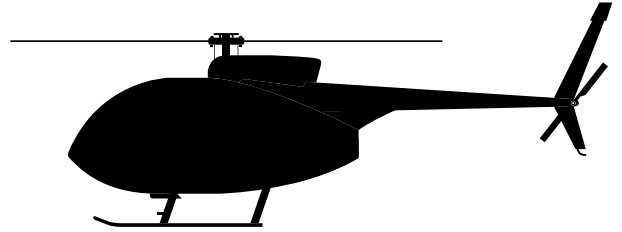
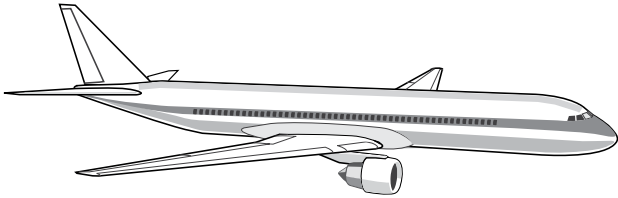

Bb Bb

balloon

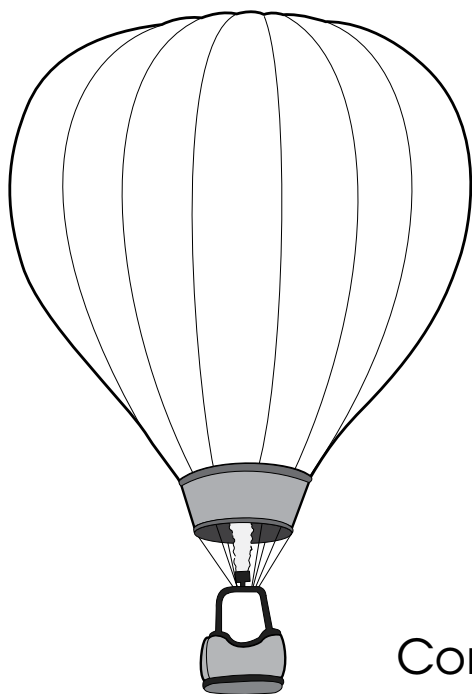
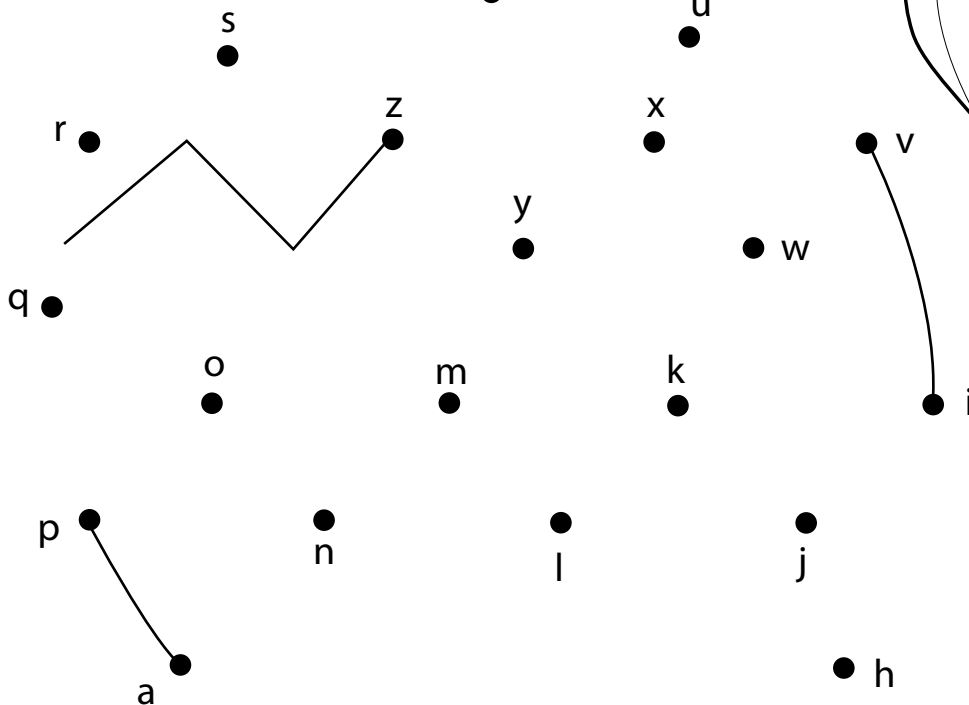
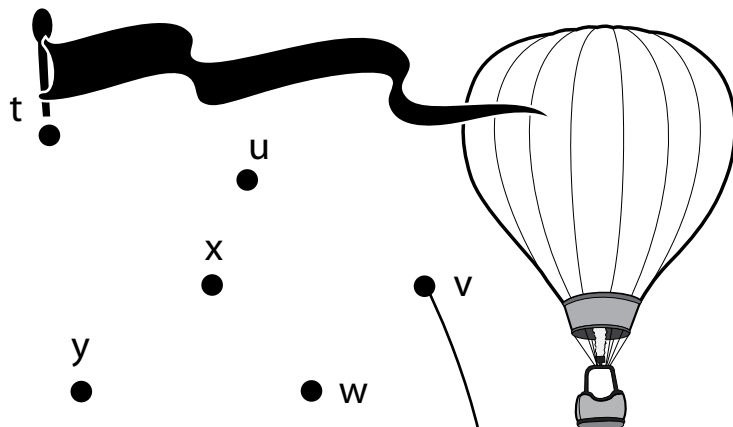

b g

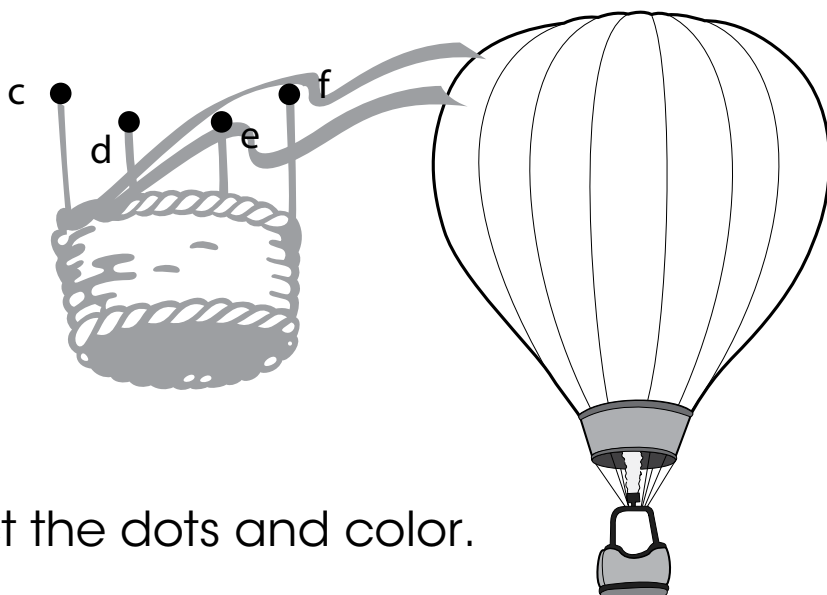

Connect the dots and color.

Cc Cc

# clouds

Count the pictures hidden in the **clouds**.

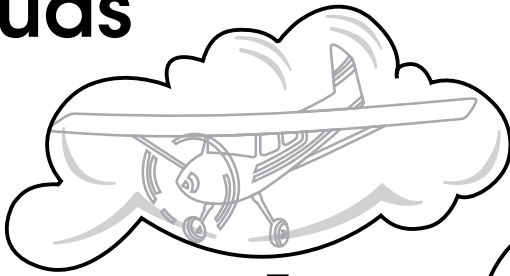

1



—

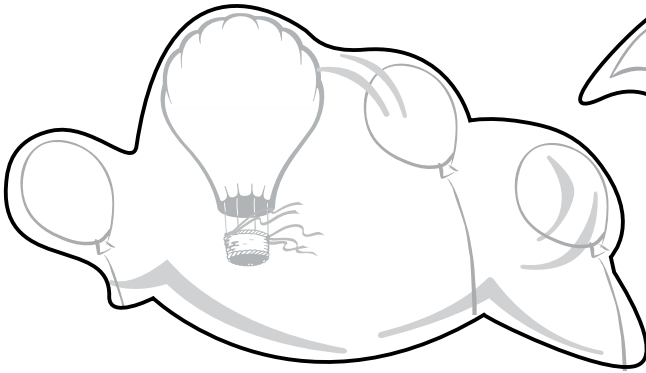

—

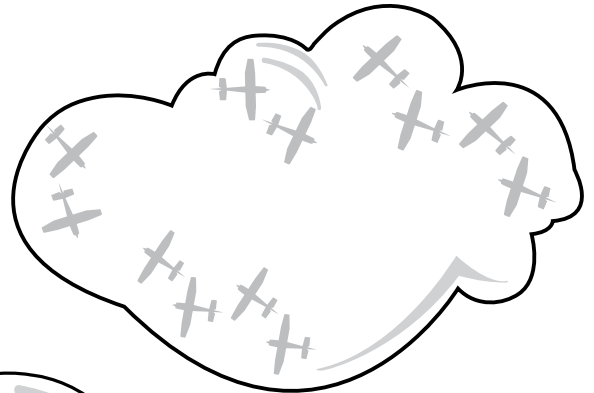

—

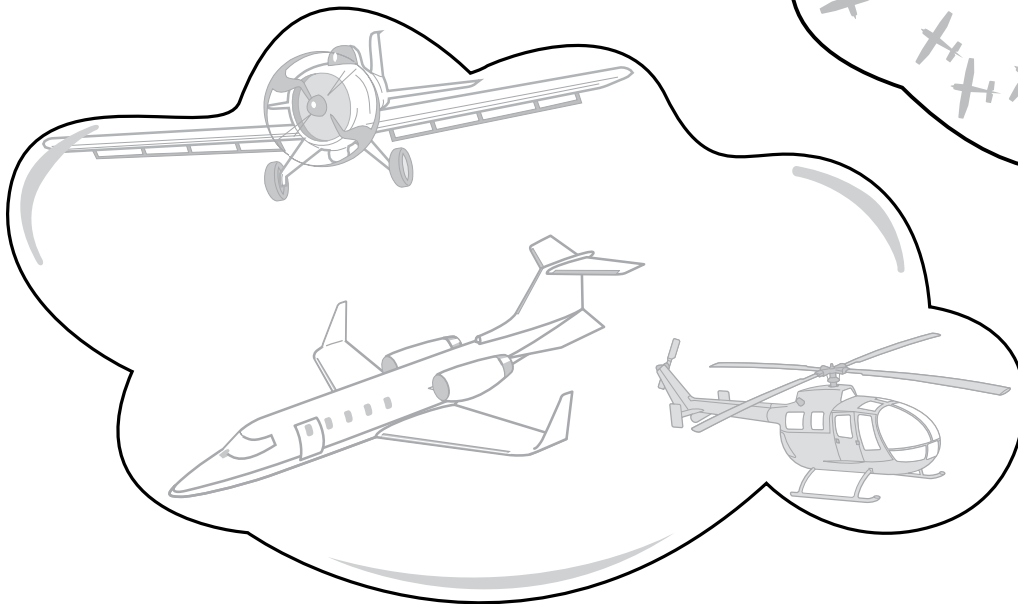

—



Dd Dd



# down

Follow the line and help the skydiver guide the parachute **down** to the target.



E e E e

## engine

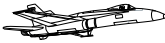
Each aircraft has a different type of engine. The engines move the aircraft through the air at different speeds. A passenger jet  flies through the air at 550 miles per hour. A smaller private aircraft  flies through the air at 410 miles per hour. A fighter jet  flies through the air at 1,500 miles per hour.

The chart below shows the speed at which each aircraft flies. Use the graph below to complete the activity on the next page.

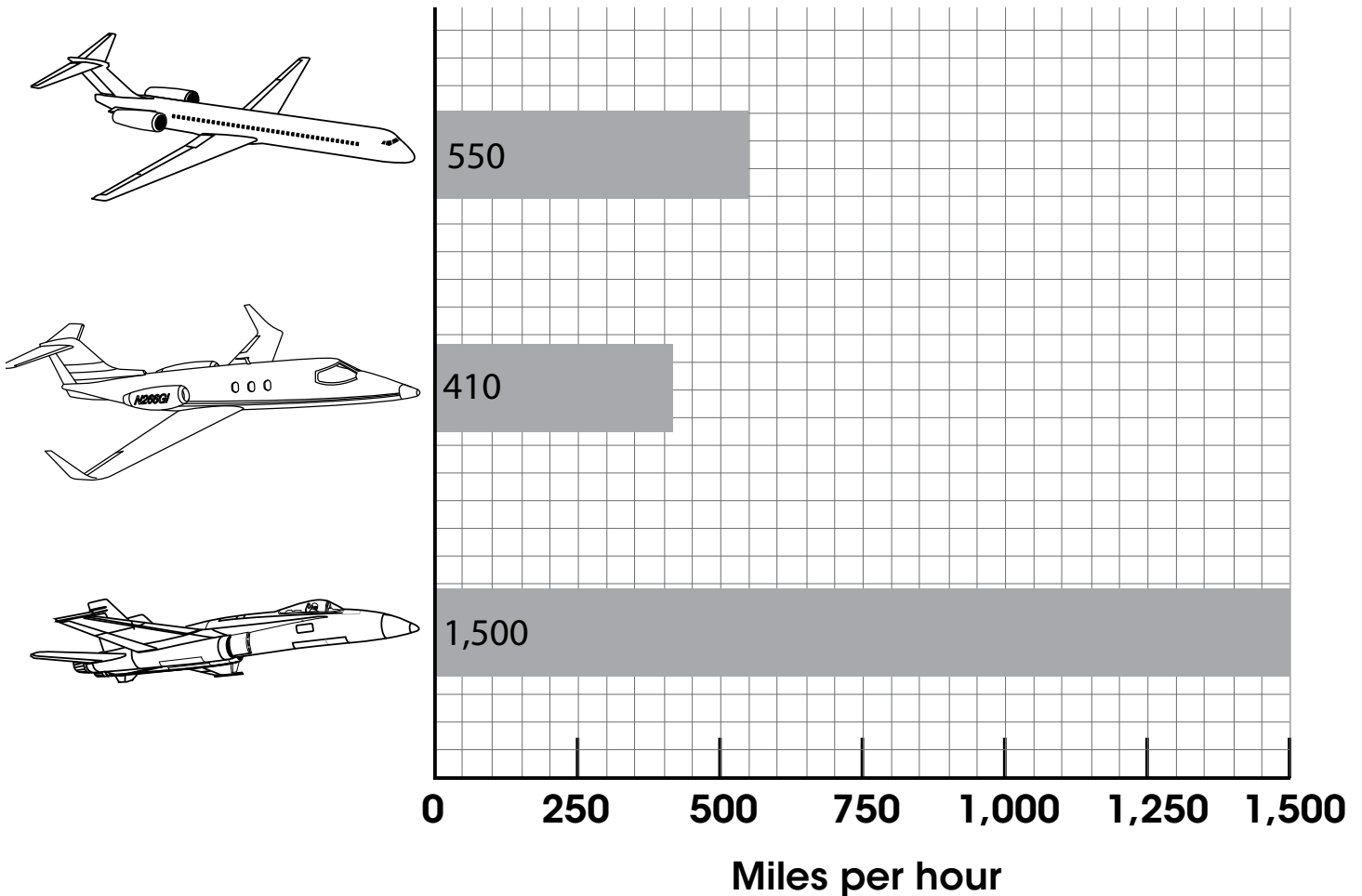

There was an airplane race. Draw a line from the trophy to the aircraft in the order it finished.

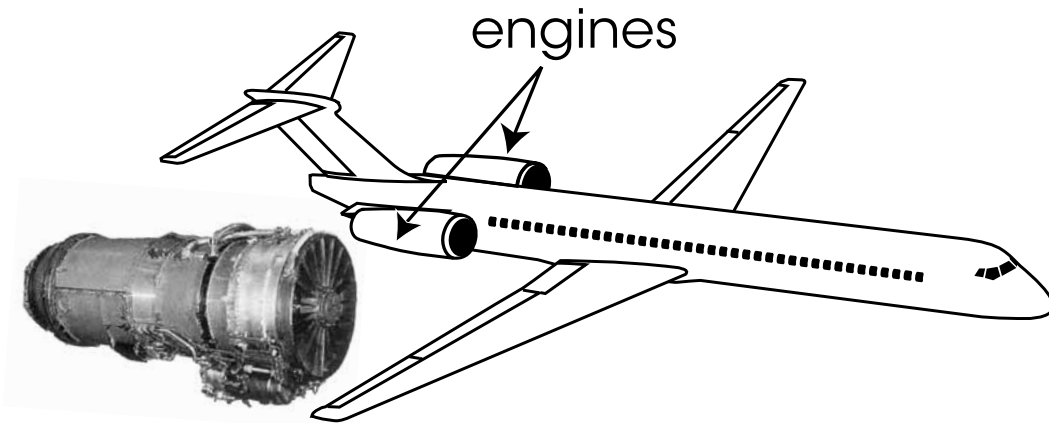

**1,500 mph**

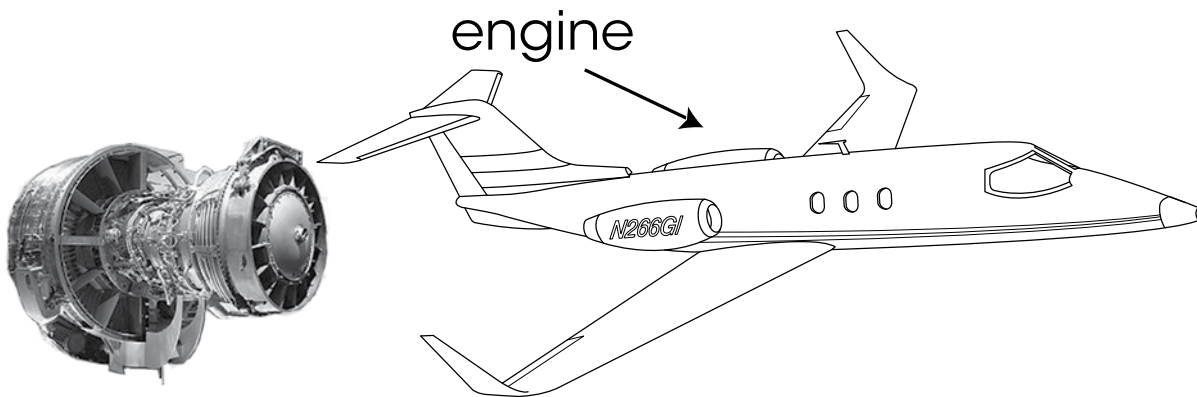

**410 mph**

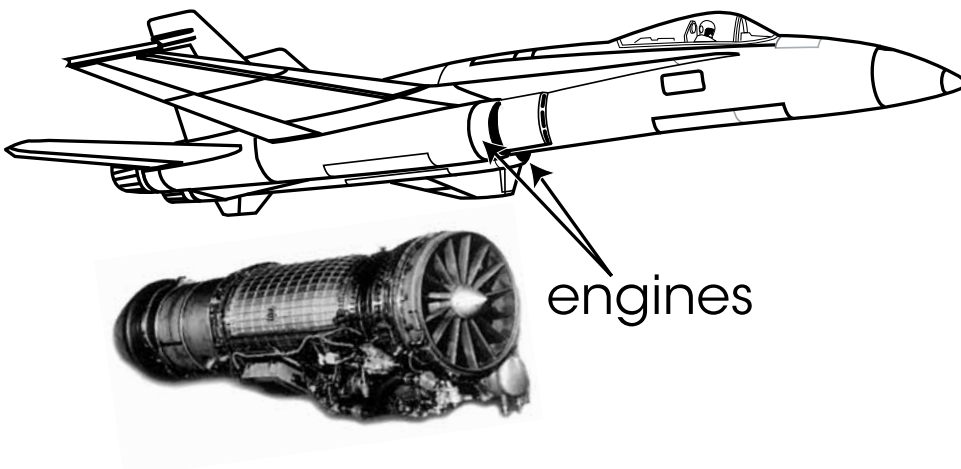

**150 mph**

Ff Ff

# fly

Circle the pictures of the things that fly.

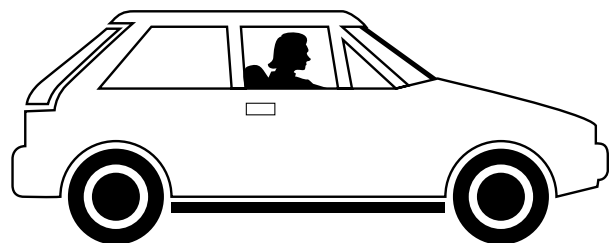
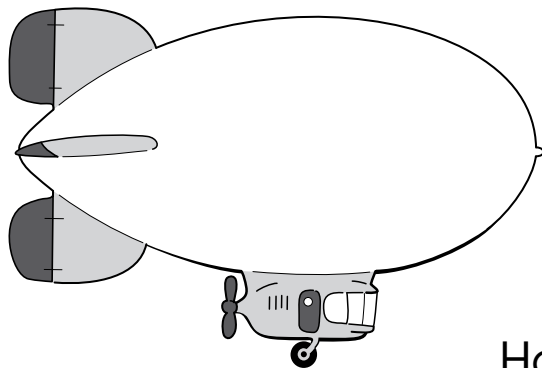
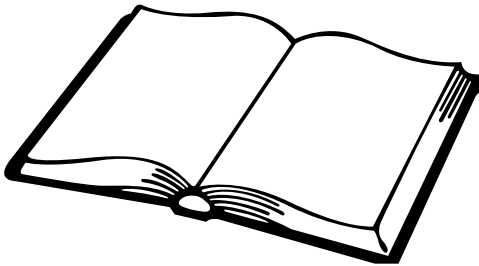
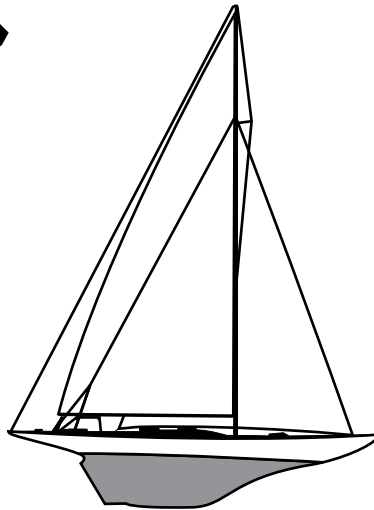
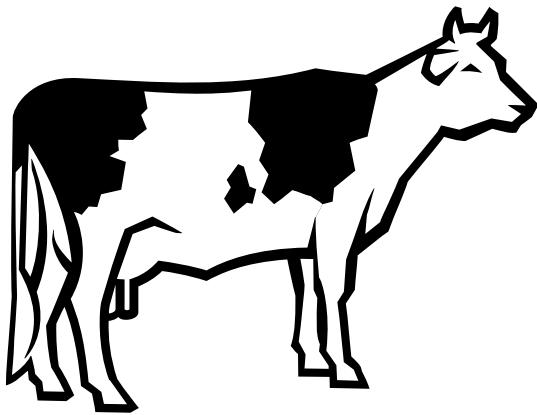
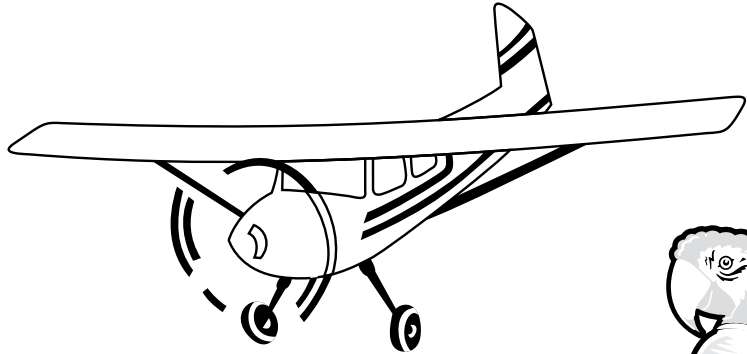

How many did you circle? \_\_\_\_\_

Gg Gg

glider

### Materials Needed

Scissors

Cellophane tape

One penny

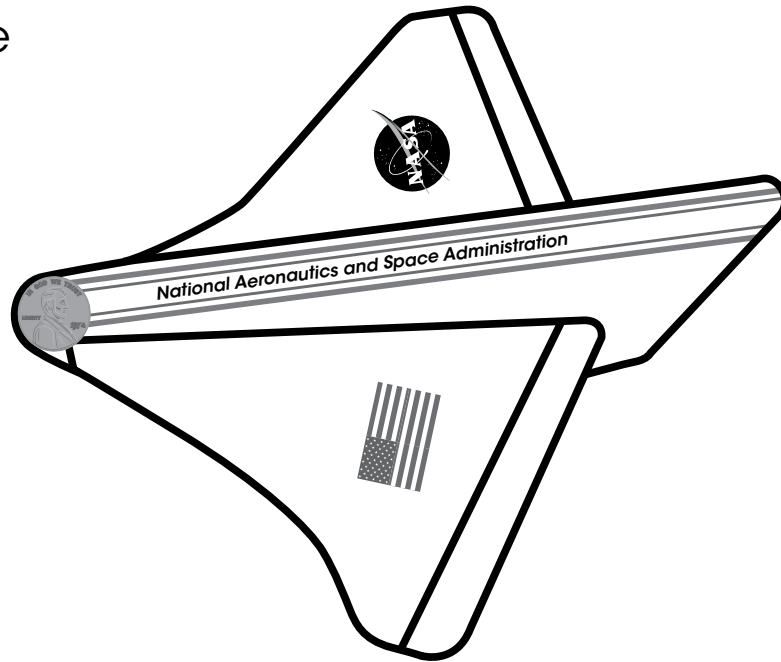

### Instructions

1. Cut out the wing and fuselage patterns that can be found on the back cover of this book.
2. Carefully cut on the wing slot line located on the fuselage.
3. Slide the wing into the slot, making sure that the wing center line is within the fuselage.
4. Tape the wing to the fuselage.
5. Tape the penny to the nose of the fuselage for balance.
6. Bend both elevons upward.
7. Gently toss the **glider**.

Hh Hh

# helicopters

Add the **helicopters** in each group.

Military

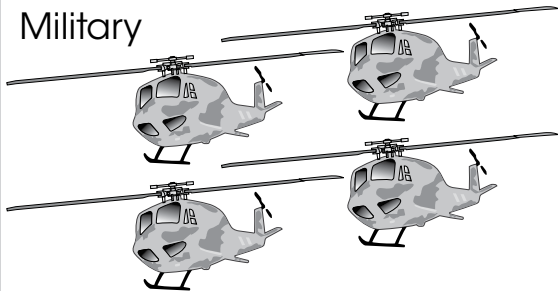

\_\_\_\_\_

+

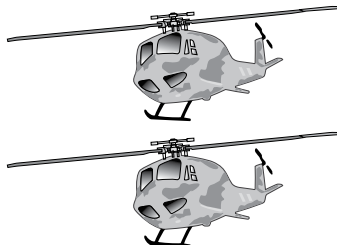

\_\_\_\_\_

=

\_\_\_\_\_

Coast Guard

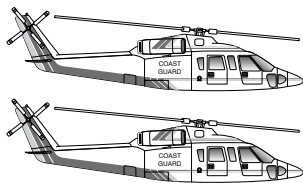

\_\_\_\_\_

+

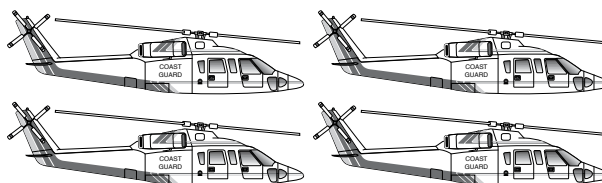

\_\_\_\_\_

=

\_\_\_\_\_

Traffic Reporter

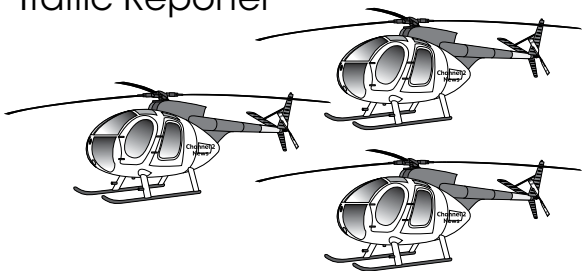

\_\_\_\_\_

+

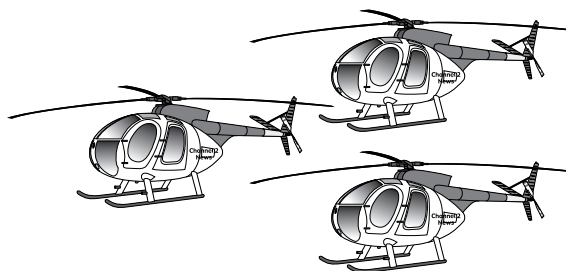

\_\_\_\_\_

=

\_\_\_\_\_

Emergency Rescue

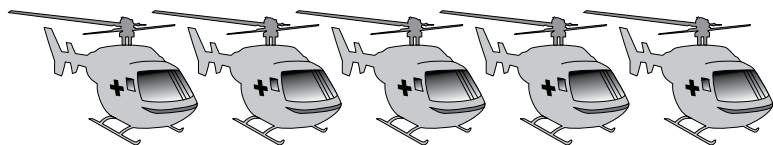

\_\_\_\_\_

+



\_\_\_\_\_

=

\_\_\_\_\_

Ii

in

Draw a line to where the passengers, luggage, and engine go **into** the airplane.

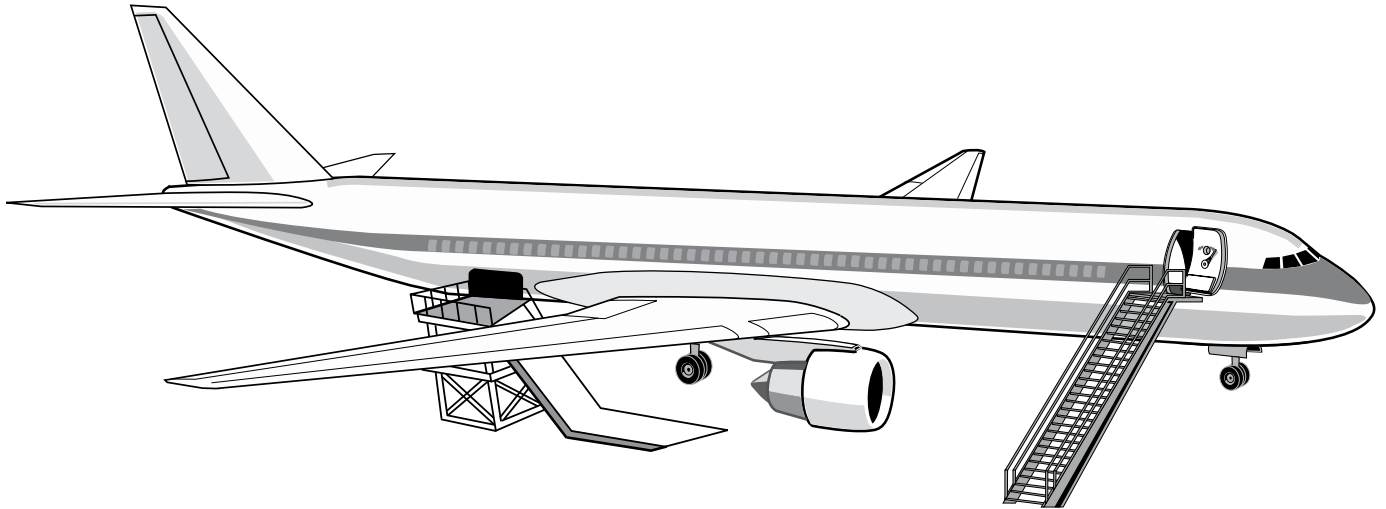

passengers

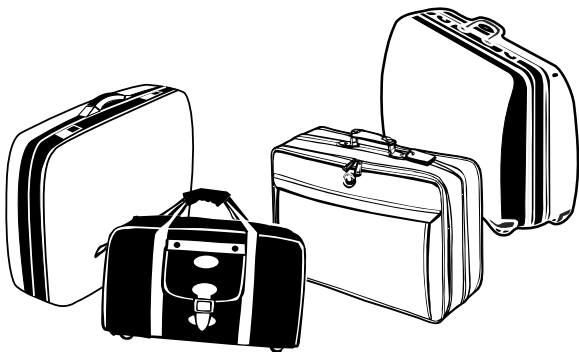

luggage

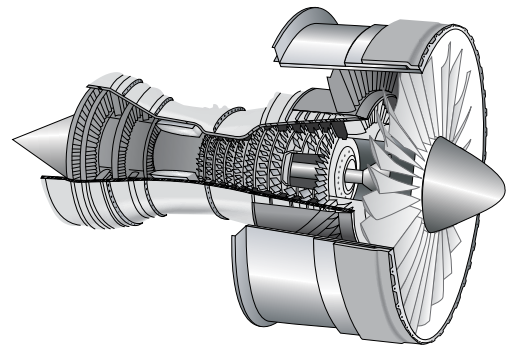

engine

Jj Jj

# jet

Circle the aircraft that is not a **jet**.

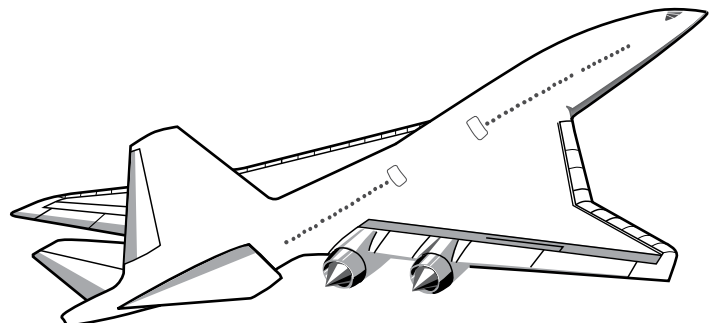
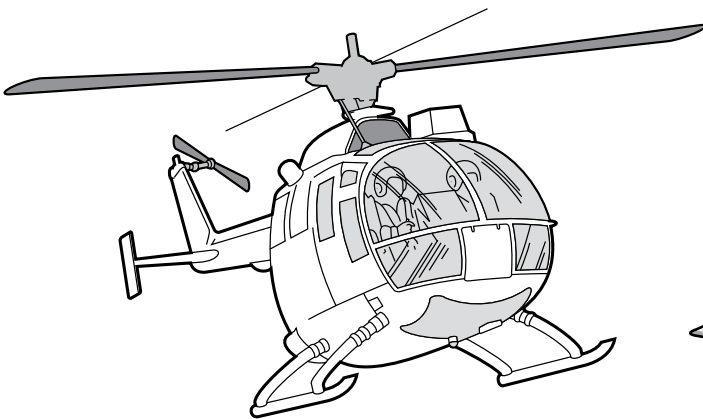
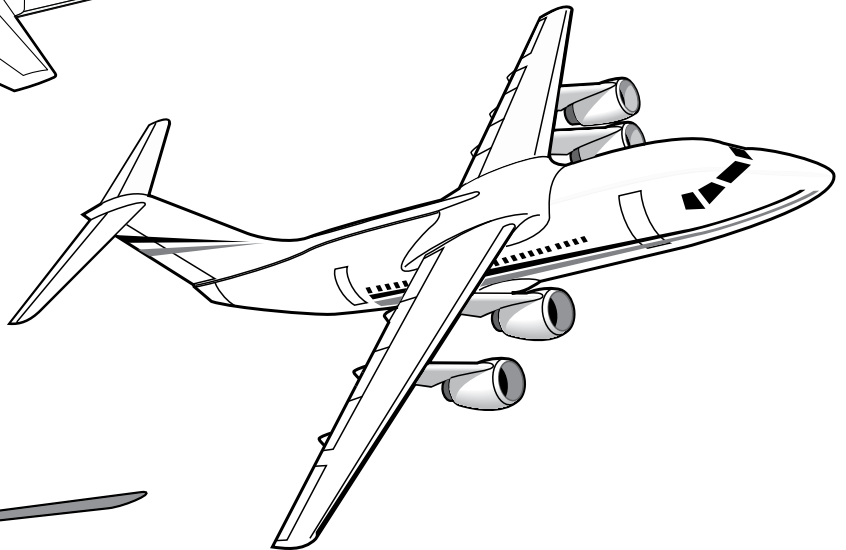
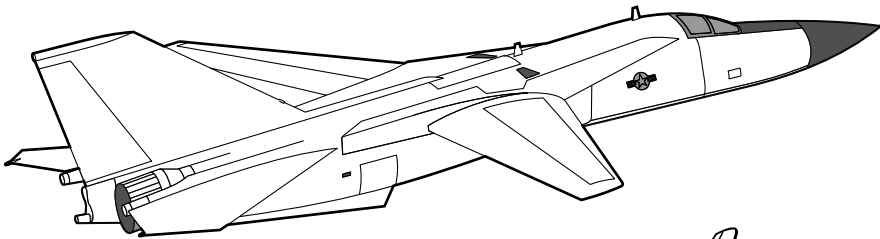
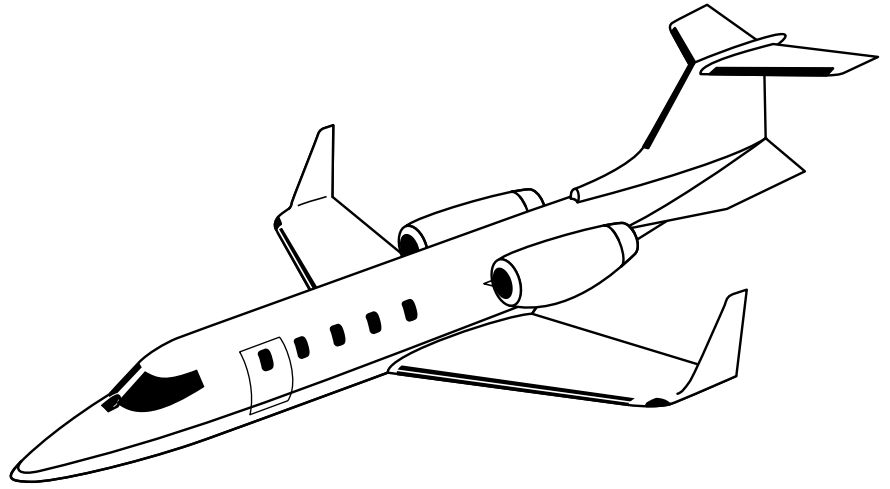



Kk

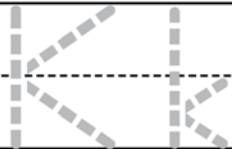

kite

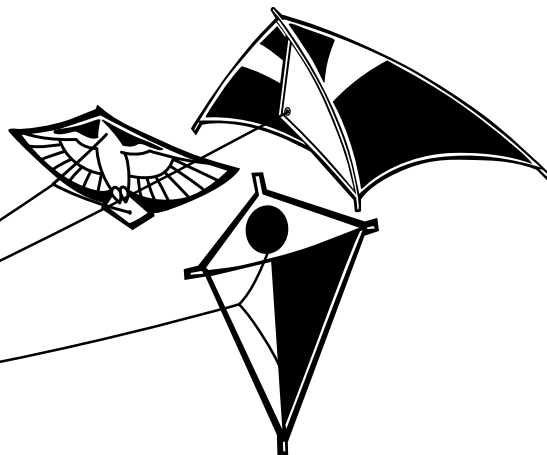

Color which type of day would be best for flying a **kite**.

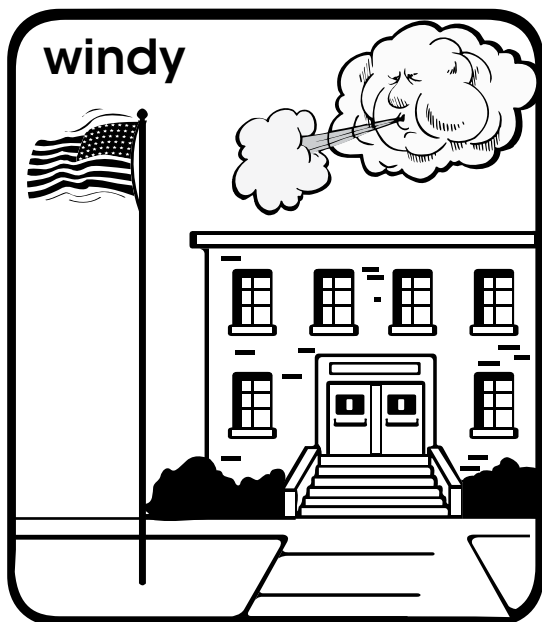
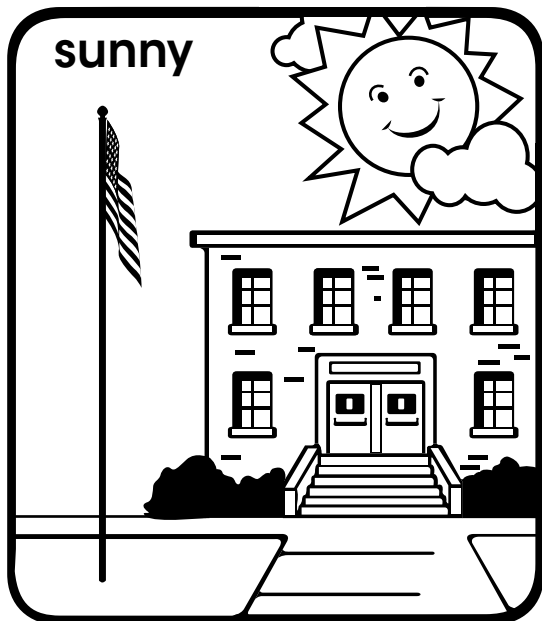

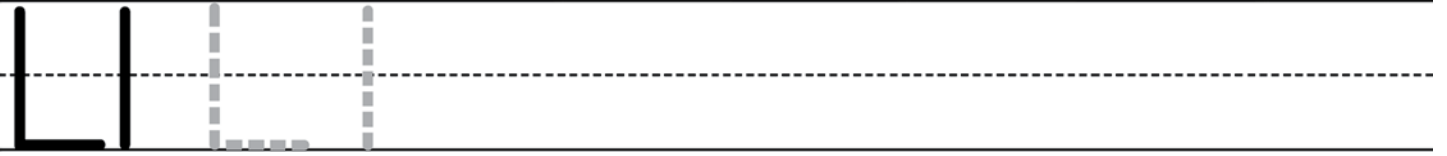

# landing

The aircraft below are **landing**. Draw a line to match each aircraft to where it would land.

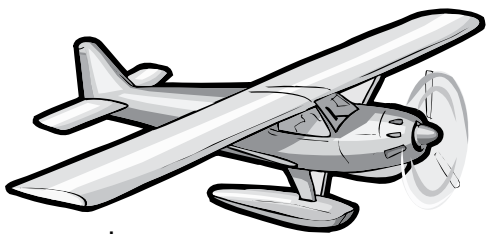

seaplane

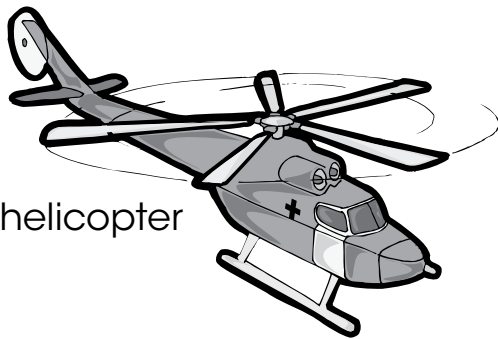
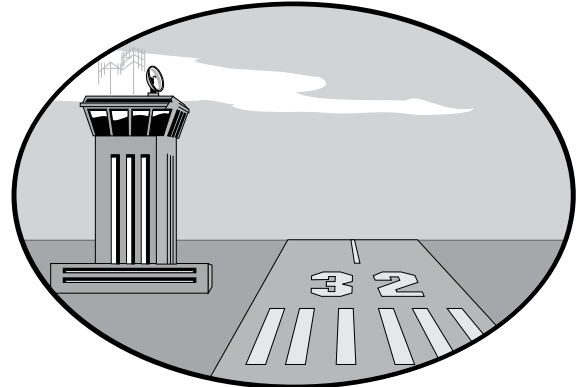

helicopter

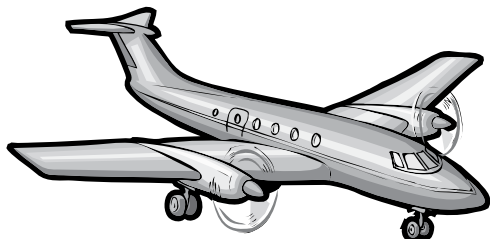
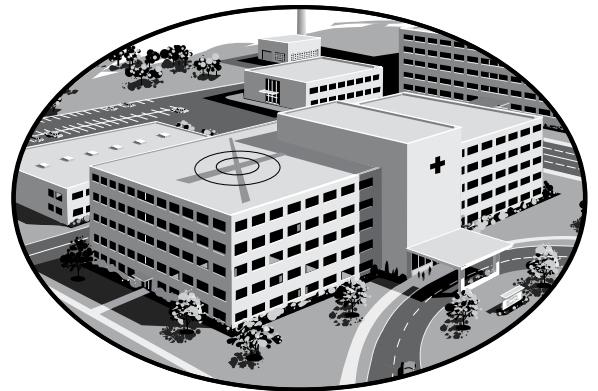

passenger plane

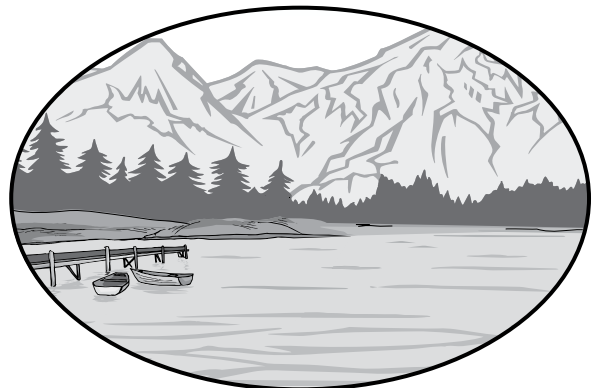

Mm Mm

# mechanic

Connect the dots to see what type of tools a **mechanic** uses.

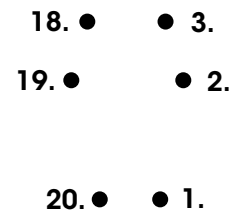
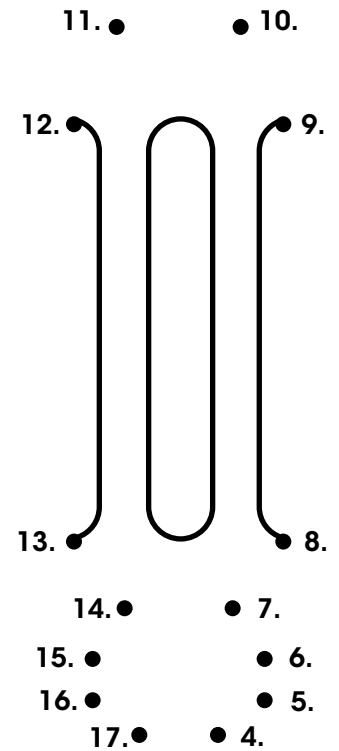
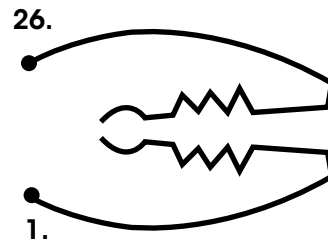
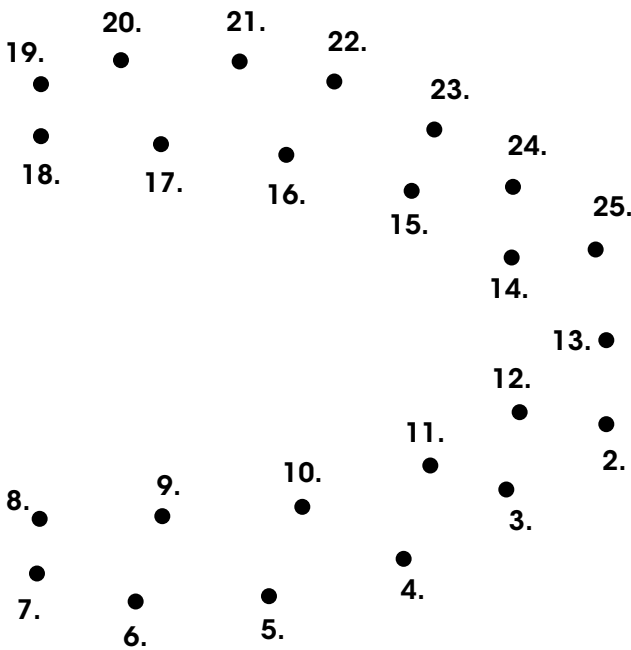
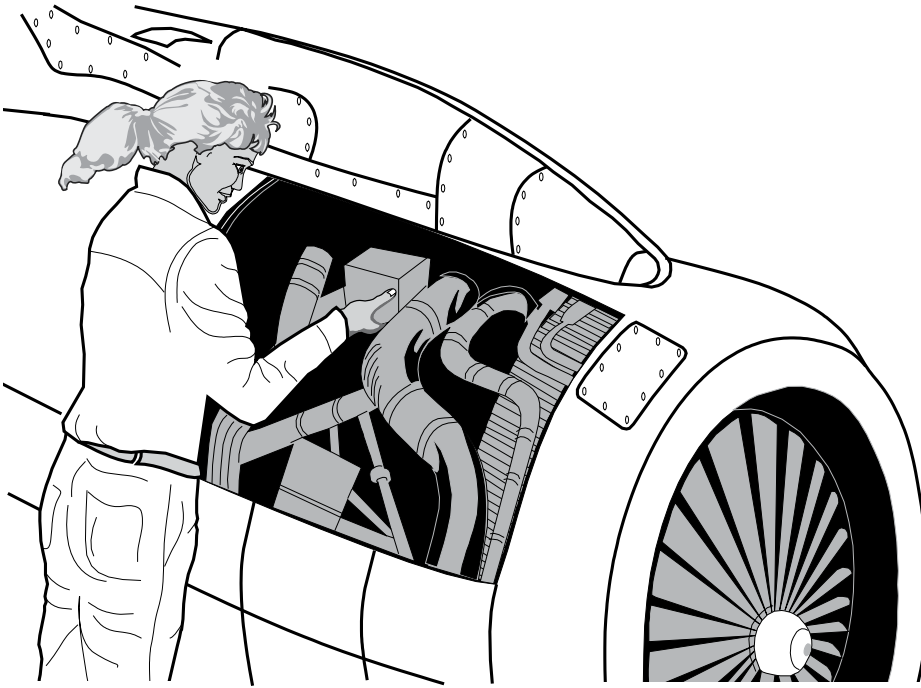

Nn Nn

# NASA

National Aeronautics and Space Administration (**NASA**) logo.  
Color parts of the NASA logo numbered 1 blue and 2 red.

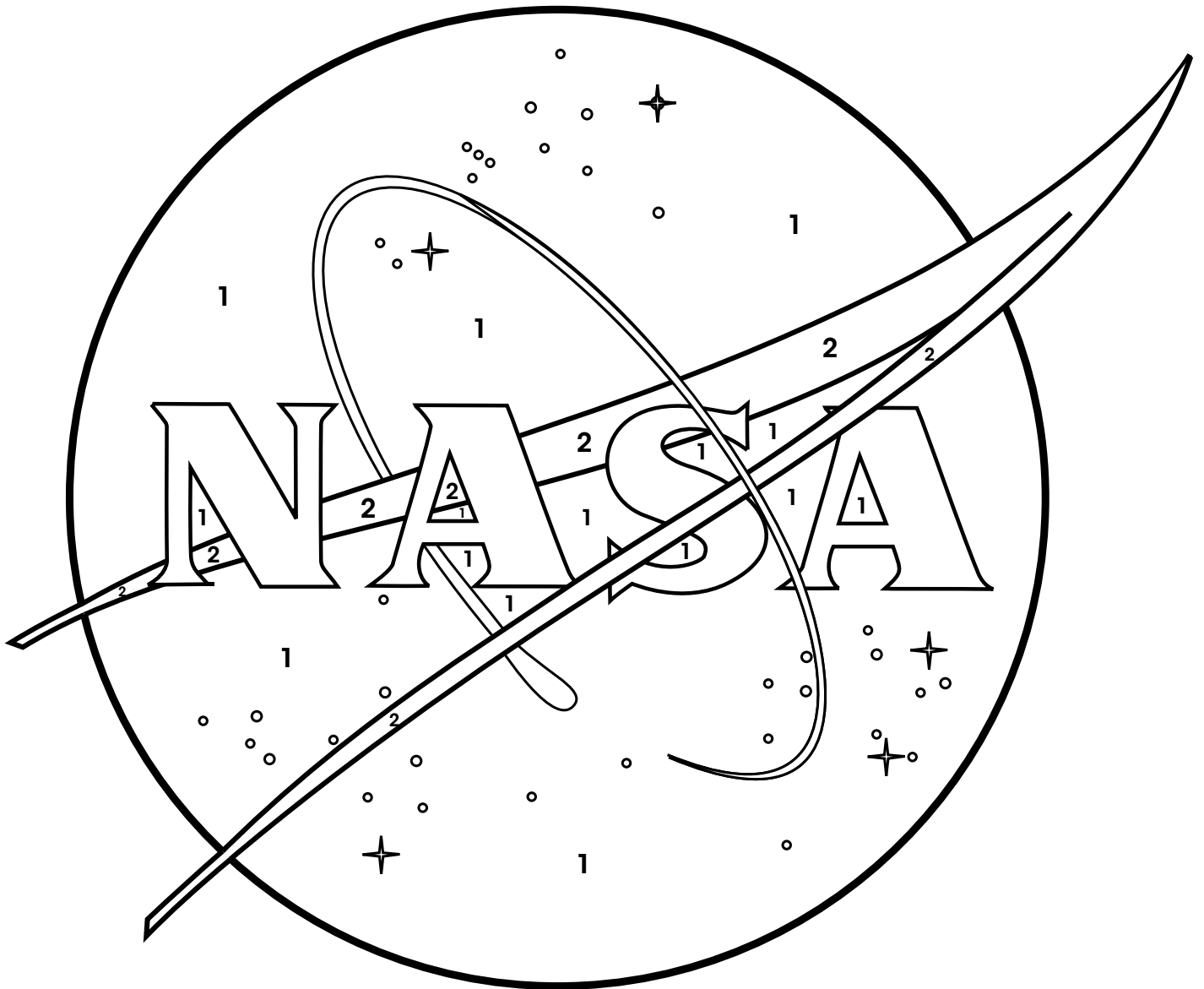

The NASA Insignia (more commonly referred to as the "meatball") reflects the history and tradition of the Agency and is used in all of the Agency's day-to-day communications materials. Designed in 1959 by former NASA employee James Modarelli of NASA Glenn Research Center, the NASA Insignia contains the following elements: the sphere represents a planet, the stars represent space, the vector represents aeronautics, and the orbit represents space travel.

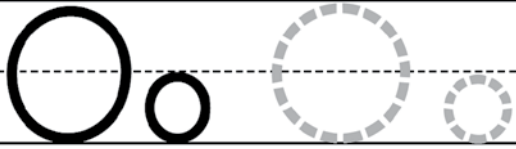

# oxygen mask

Does the pilot have his **oxygen mask** on or off? Under each picture, circle the word **on** or **off**.

How many pilots have their oxygen masks on? \_\_\_\_\_

How many pilots have their oxygen masks off? \_\_\_\_\_

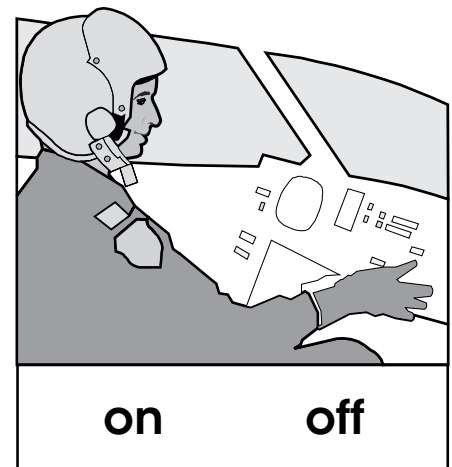
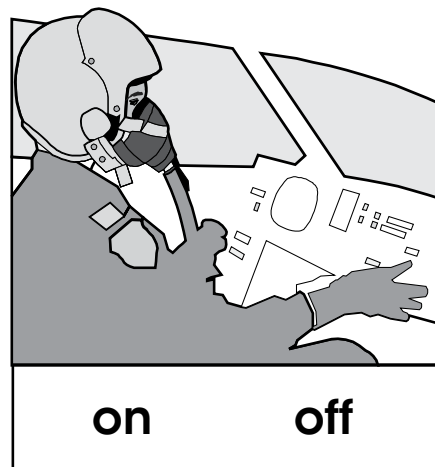
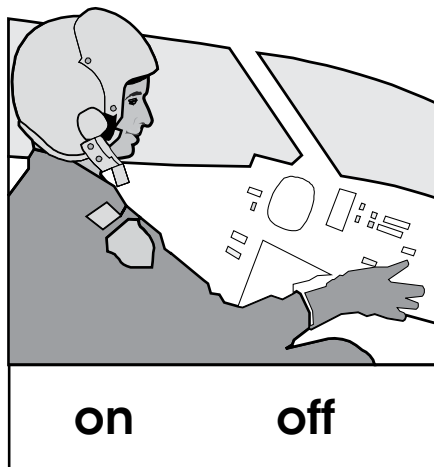
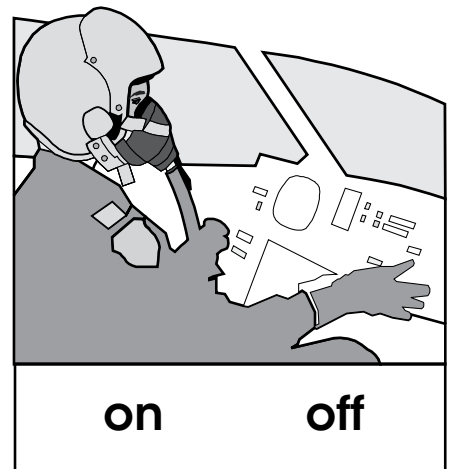
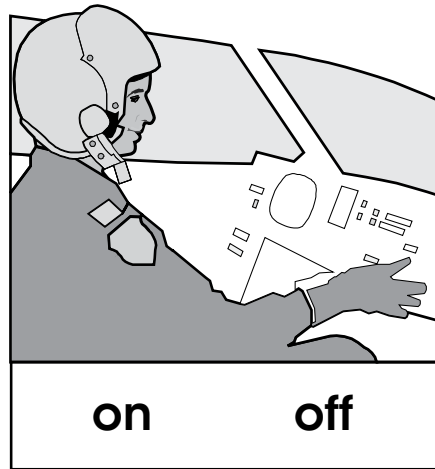
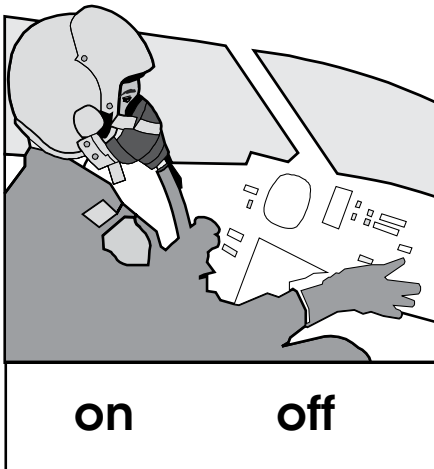

Pp Pp

# pilot

A **pilot** uses instruments in the cockpit to fly. Color the circles green, the squares red, the triangles yellow, and the rectangles blue.



Qq Qq

# quick

Your family is going on a trip far away. Under each picture is the time it will take each vehicle to get there. Circle the vehicle that will get you there the **quickest**.

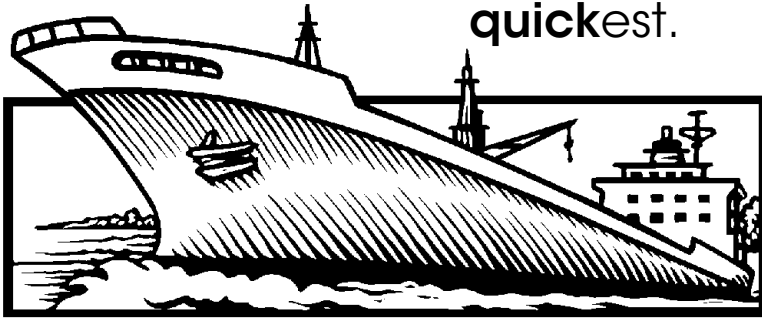

2 weeks

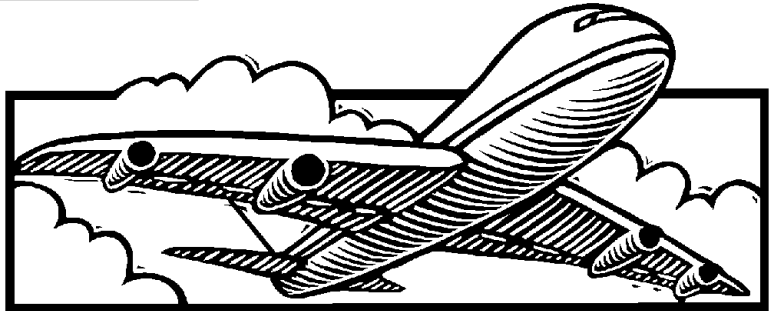

2 hours



1 day



3 days

Rr Rr

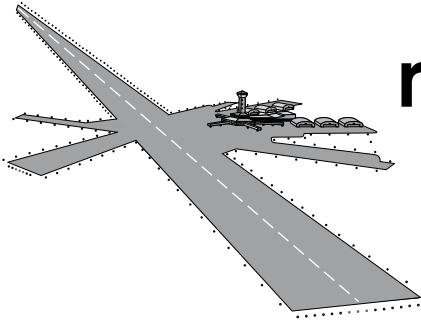

runway

Help the airplane find the runway through the maze.

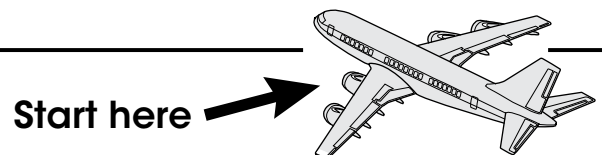
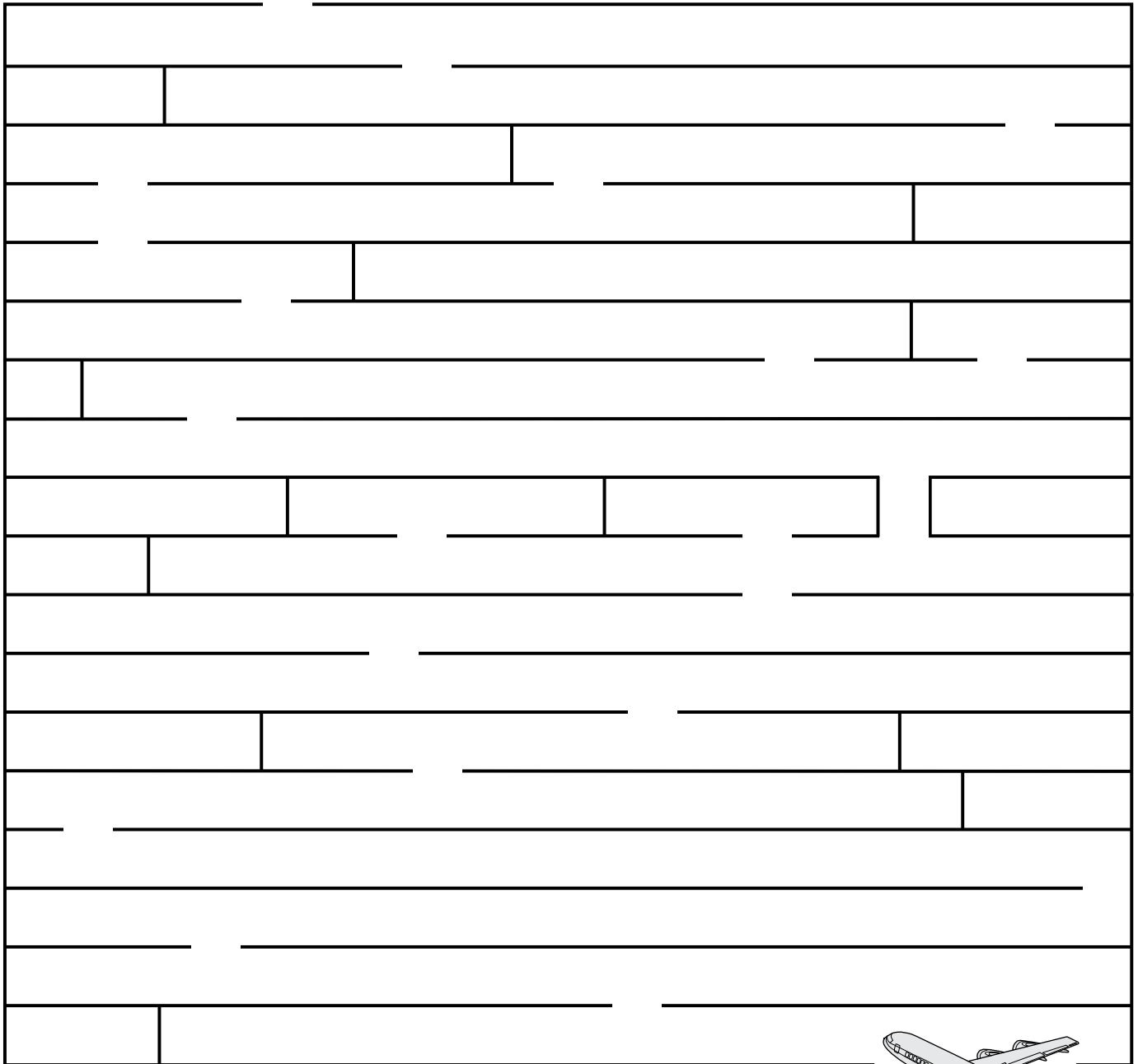



Ss

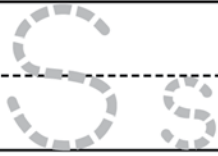

# sky

Draw and color at least three things that can fly in the **sky**.

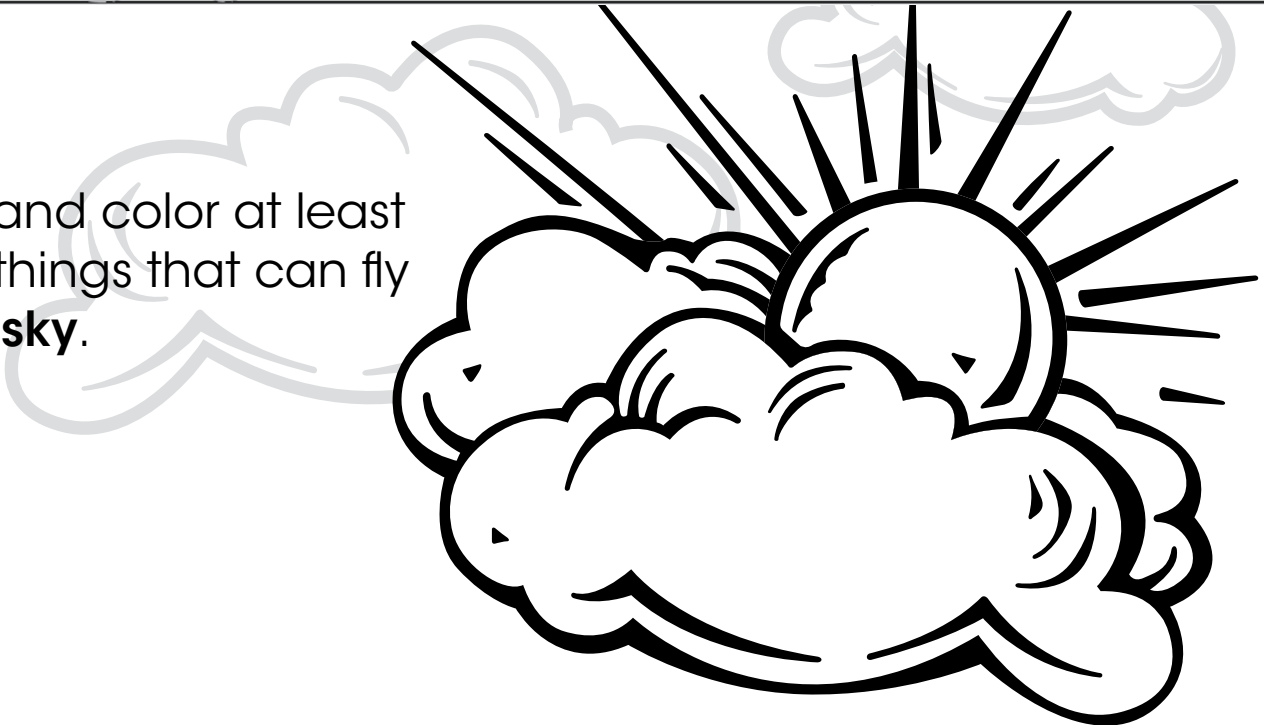

Tt Tt

# takeoff

Write the number under the matching picture.

1. Loading
2. **Takeoff**
3. Flying
4. Landing

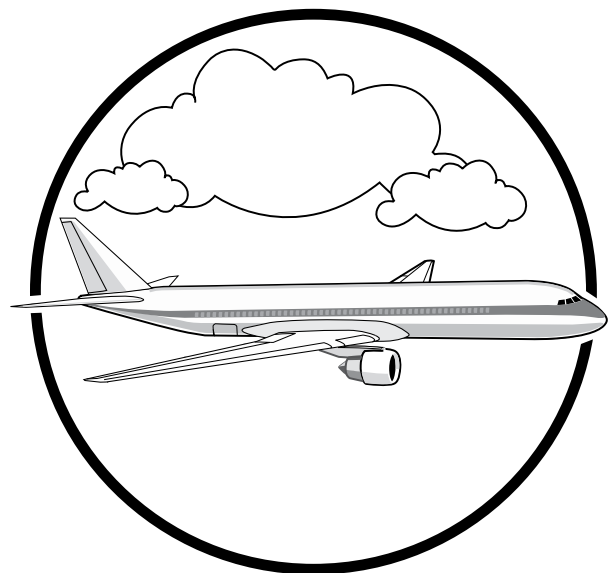
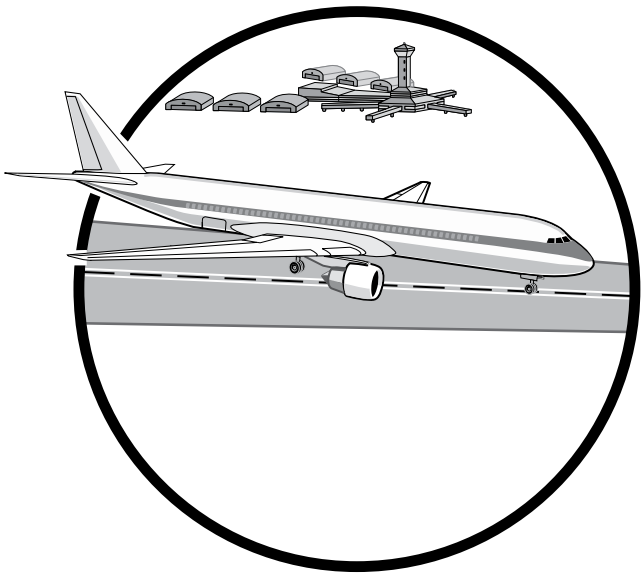
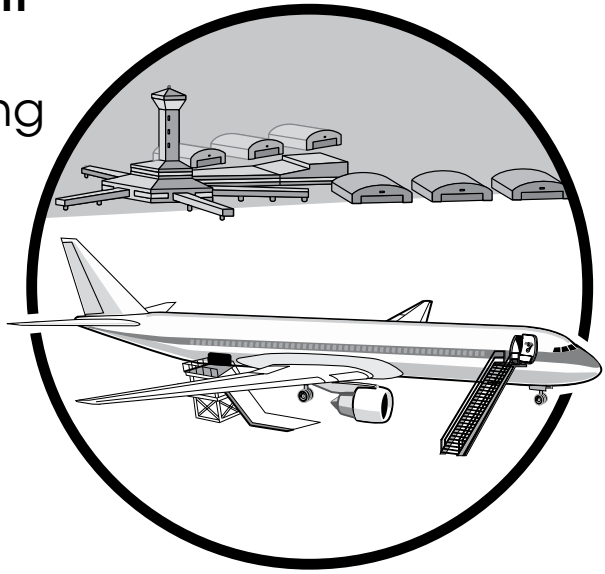
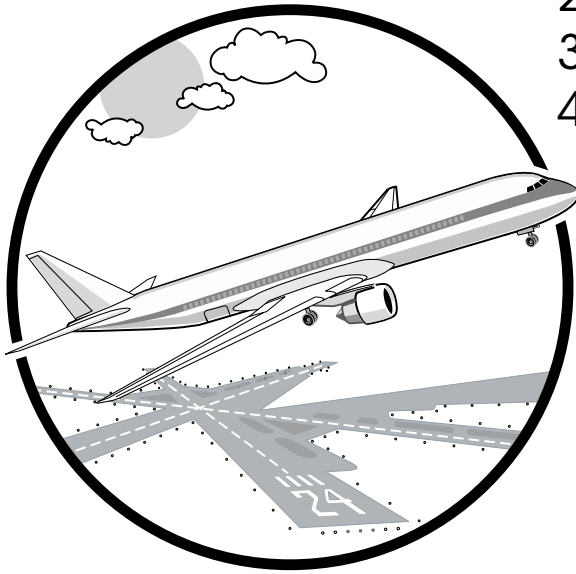

Uu Uu

up

Circle the object in each group that does not go **up** in the air.

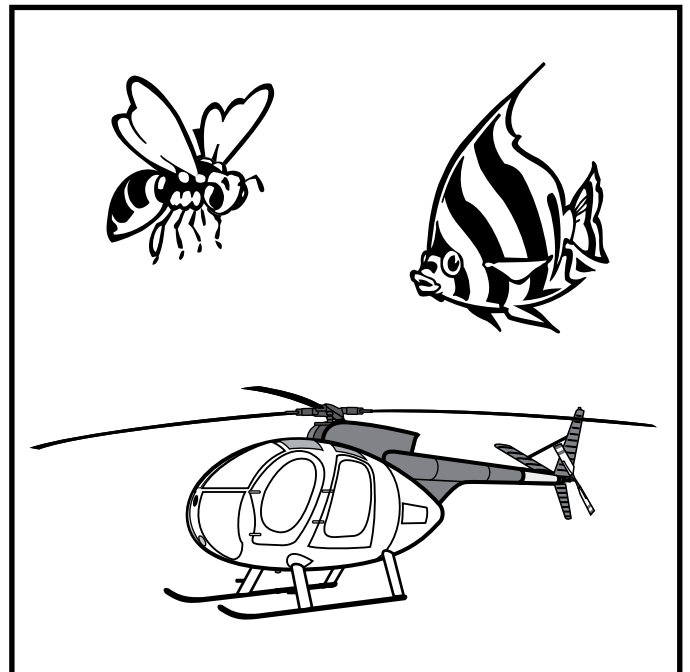
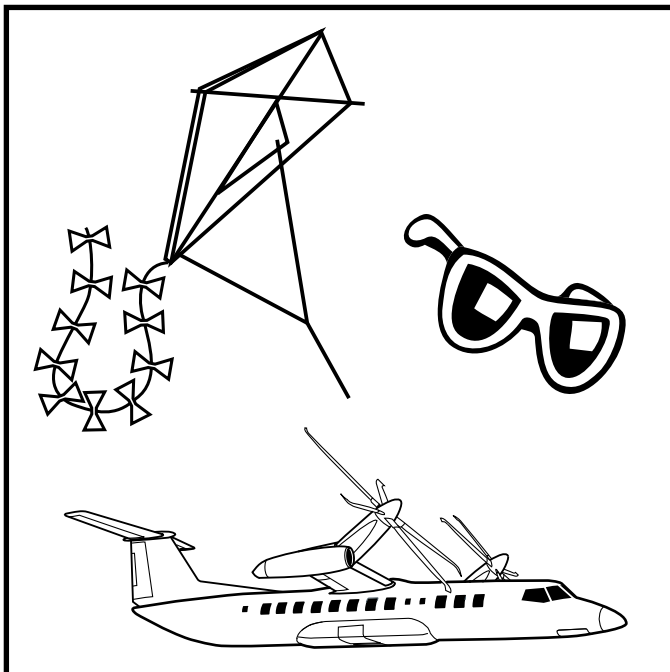
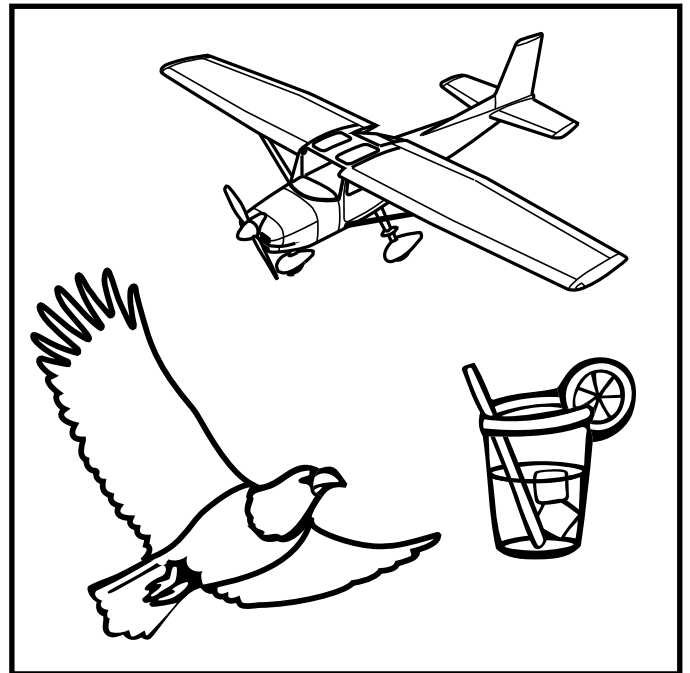
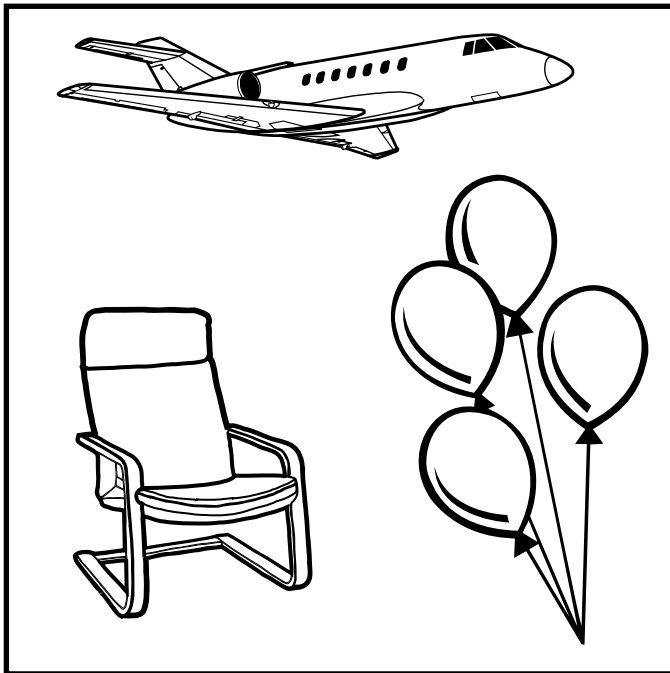

Vv Vv

# view

To complete the entire **view** of the airplane, draw the other half.

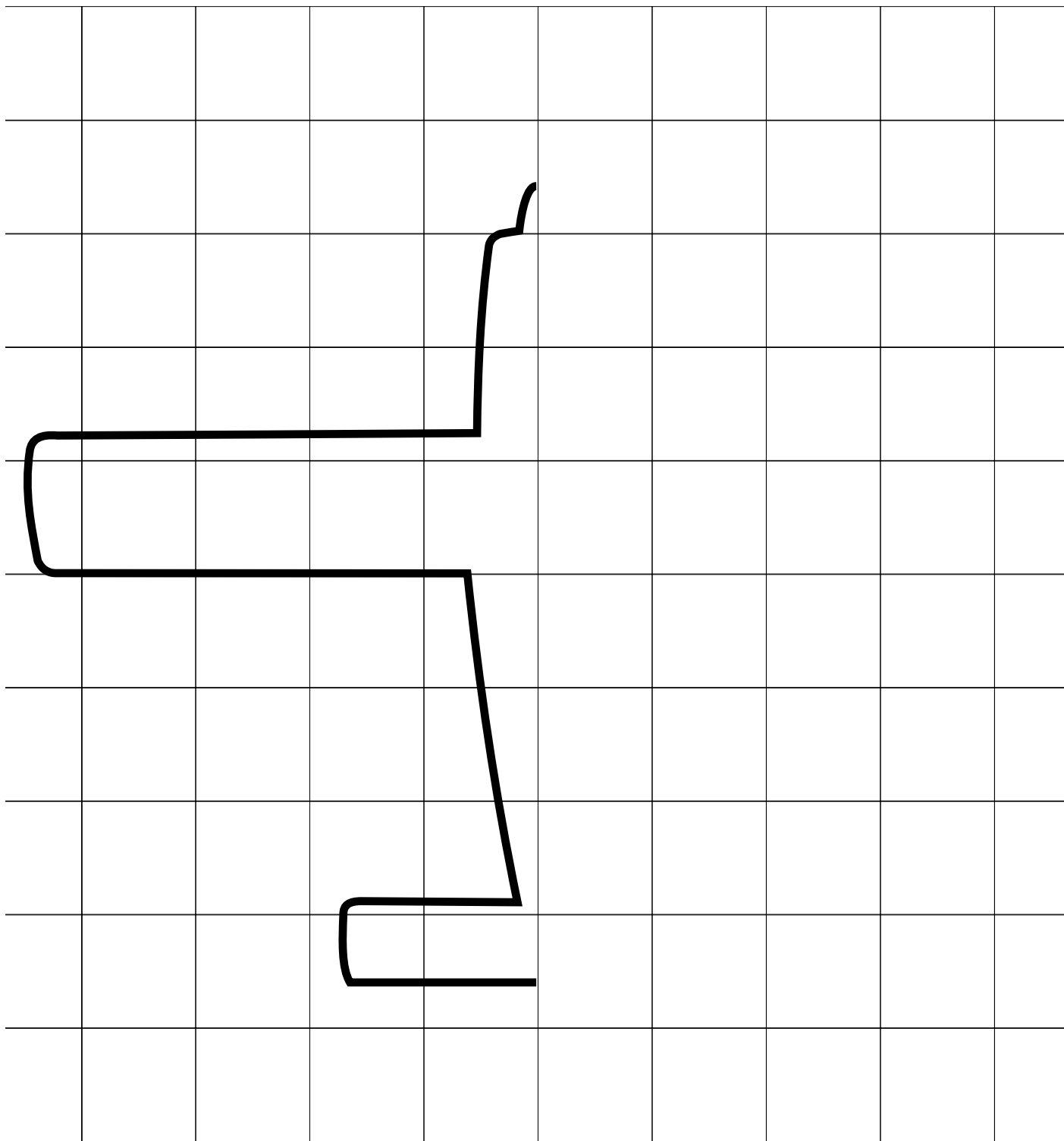

W w W w

# wing

Trace the different **wing** shapes.

Wright brothers

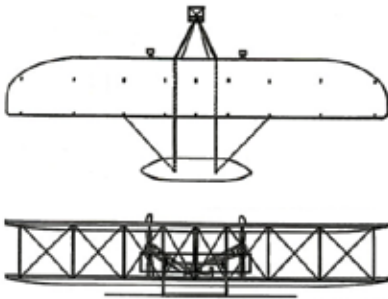

F-18  
(Blue Angels)

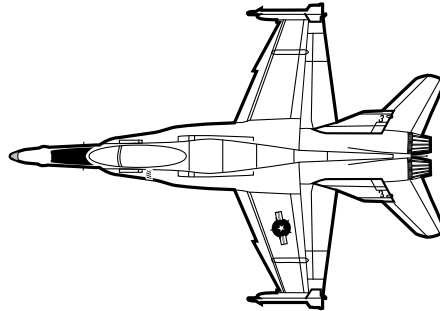

Concorde

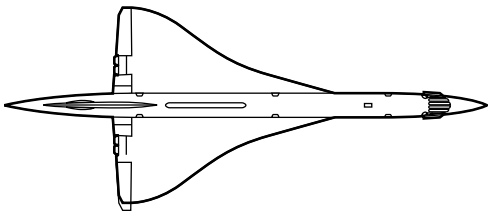

Boeing 747

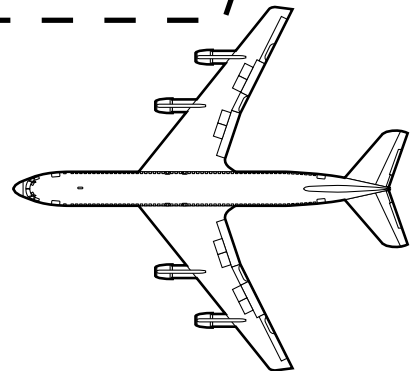

Paper airplane

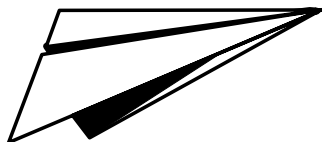

Xx Xx

# X-plane

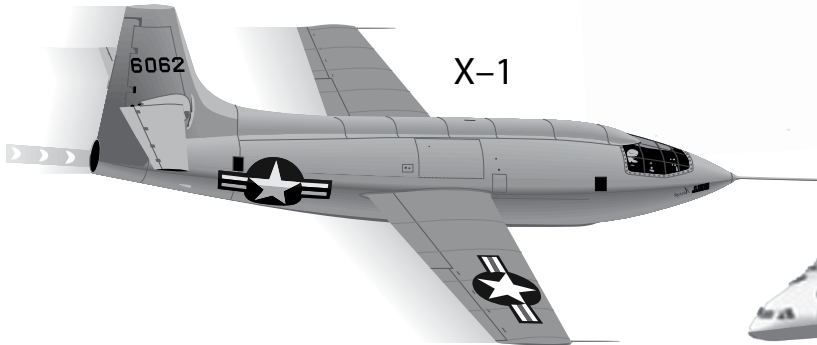
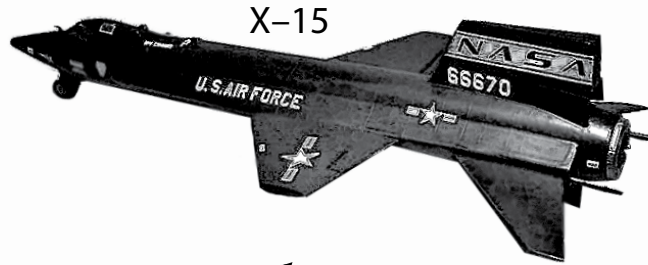

NASA uses test aircraft and space vehicles called **X-planes**. X-plane means experimental (X)-plane. Be an engineer and design your own X-plane in the space below. Give it an X-number and write it under your plane.

Yy

\_\_\_\_\_

-----

\_\_\_\_\_

Would **you** like to take an airplane ride? Whom would you take with you? Draw their faces in the windows. Don't forget your face!

**you**

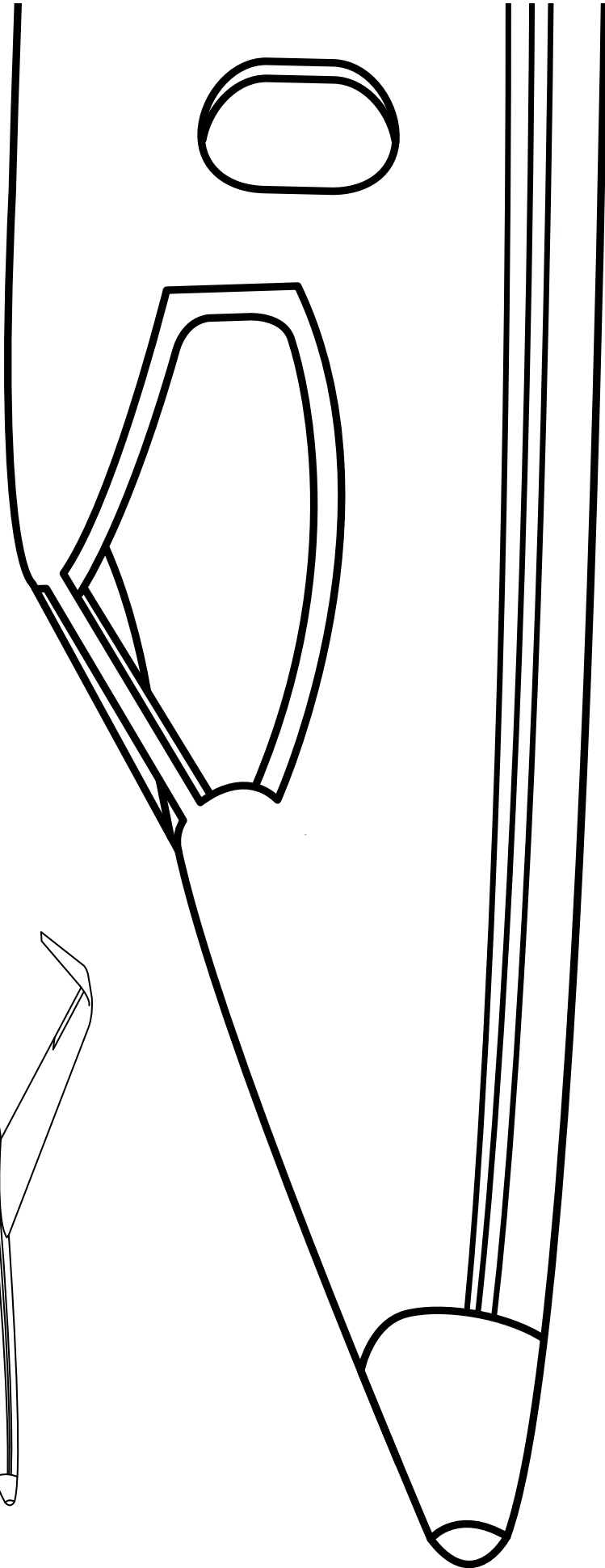
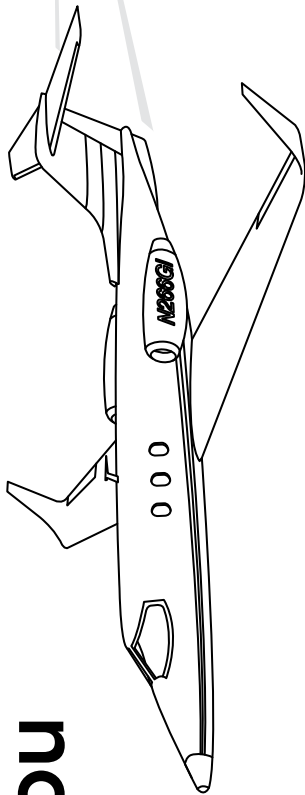

Where would **you** go on your airplane ride? \_\_\_\_\_

Zz Zz

# zoom

Count the number of airplanes in each group as they zoom by.

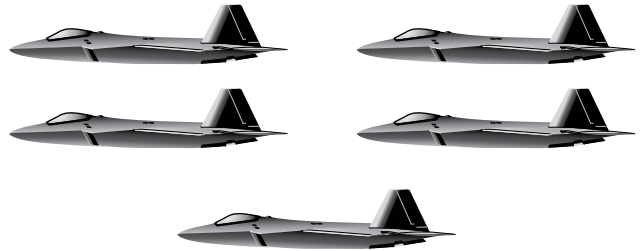
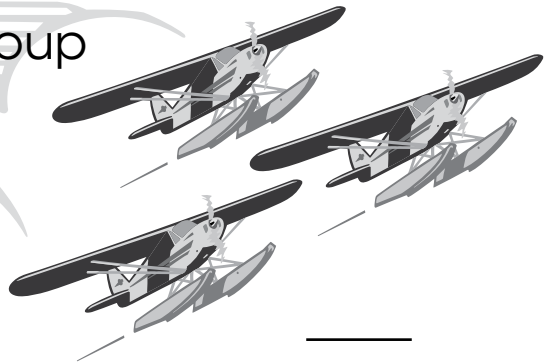
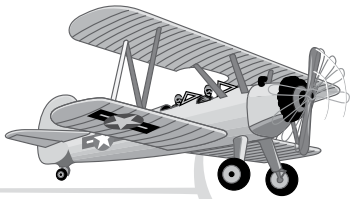
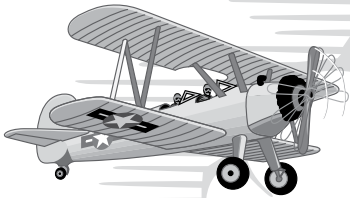

How many airplanes did you count? \_\_\_\_\_

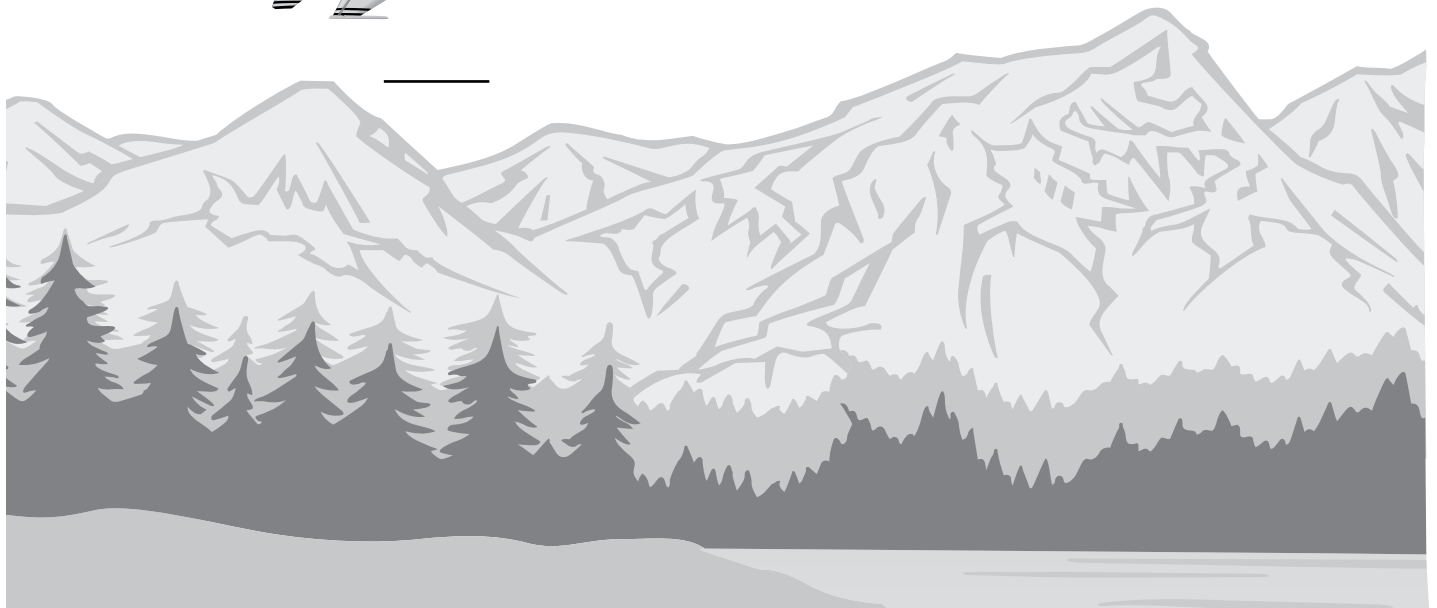



Aa aircraft

Aa aircraft

Bb balloon

Bb balloon

Cc clouds

Cc clouds

Dd down

Dd down

Ee engine

Ee engine

Ff fly

Ff fly

Gg glider

Gg glider

Hh helicopters

Hh helicopters

Ii in

Ii in

Jj jet

Jj jet

Kk kite

Kk kite

Ll landing

Ll landing

Mm mechanic

Mm mechanic

Nn NASA

Nn NASA

Oo oxygen

Oo oxygen

Pp pilot

Pp pilot

Qq quick

Qq quick

Rr runway

Rr runway

Ss sky

Ss sky

Tt takeoff

Tt takeoff

Uu up

Uu up

Vv view

Vv view

Ww wing

Ww wing

Xx X-plane

Xx X-plane



Yy you

Yy you

Zz zoom

Zz zoom

# Airplane Parts Definitions

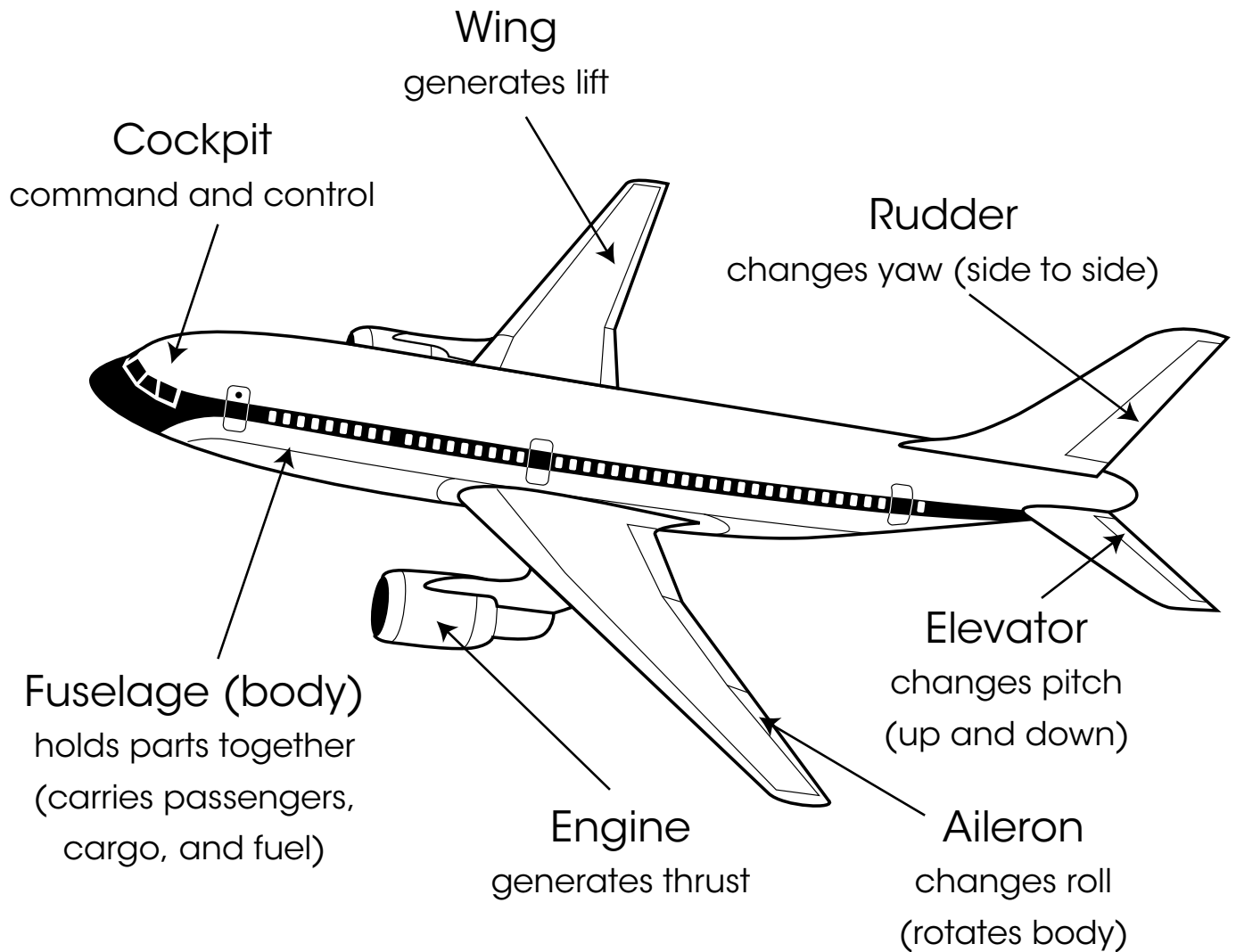

## GLOSSARY



### **Aeronautics**

The science of making and flying aircraft.

### **Aileron**

A hinged flap on the back edge of the wing of an airplane; the flap is moved up or down to keep the airplane steady or make a turn in the air (refer to picture on page 40).

### **Aircraft**

1. An item that you can fly or float through the air.
2. Any machine for flying.

### **Airplane**

An aircraft that is kept up by the force of air upon its wings and driven forward by a jet engine or propeller.

### **Balloon**

A large bag or rubber sack that is filled with air or other gases causing it to rise and float in the air.

### **Clouds**

White or gray objects that float in the air and contain tiny water drops.

### **Cockpit**

A place where the pilot or crew sits to control the aircraft (refer to picture on page 40).

### **Elevator**

A part of the tail of an airplane that can be moved to make the airplane go up or down (refer to picture on page 40).

### **Elevon**

A control surface on an airplane that combines the functions of an elevator and an aileron.

### **Engine**

A machine, such as an aircraft engine, that uses energy of some kind to create motion and do work (refer to picture on page 40).

### **Engineer**

A person trained and skilled in the design, construction, and use of engines, machines, or other devices of industry and everyday life.

### **Experimental**

Having to do with a test or series of tests to find out if something is correct.

**Fuselage**

The main structural body of an aircraft to which the wings and tail are attached (refer to picture on page 40).

**Glider**

An aircraft that has no engine and is carried along by air currents.

**Helicopter**

A kind of aircraft that has a large propeller fixed on top and no wings; it can be flown backward, forward, straight up, and down.

**Instrument**

A mechanical or electronic measuring device that gives pilots information they need to fly their airplanes safely.

**Jet**

An airplane that moves very quickly and is jet propelled.

**Kite**

A tethered glider that is lifted by the wind.

**Landing**

The act of coming down after flying.

**Loading**

Putting something to be carried into or upon an aircraft.

**Luggage**

The suitcases, trunks, baggage, and belongings of a passenger.

**Mechanic**

1. A worker skilled in making, using, or repairing machines, vehicles, and tools.
2. A person who repairs and maintains aircraft.

**Oxygen mask**

A mask placed over the mouth and nose and through which oxygen is supplied from an attached storage tank.

**Parachute**

A large cloth device that opens up like an umbrella and is used for slowing down a person or thing dropping from an airplane.

**Passenger**

A person traveling in an airplane but not helping to operate it.

**Pilot**

A person who operates an airplane, balloon, or other aircraft.

**Propeller**

A set of blades driven by an engine that pull or push an airplane through the air.

**Runway**

A surface on the ground specifically used for aircraft takeoffs and landings.

**Rudder**

A hinged, vertical flap at the rear of an aircraft; used for steering (refer to picture on page 40).

**Seaplane**

Any airplane designed to land on or take off from water.

**Takeoff**

The act of rising from the ground, especially in an aircraft.

**Vehicle**

An object that moves people, such as an automobile, bicycle, or aircraft.

**View**

A way of seeing or looking at something.

**Wing**

The part of an airplane that produces lift (refer to picture on page 40).

**X-plane**

A special vehicle designed for experimental flight tests.

Source definitions:

"Webster's Student Dictionary," SMITHMARK Publishers, New York, NY, 1999.  
<http://www.dictionary.com>

"Flight," The Nature Company Discoveries Library, Time-Life Books, 1995.

Little Explorers Picture Dictionary from EnchantedLearning.com  
<http://www.littleexplorers.com/Dictionary.html>

# Answer page

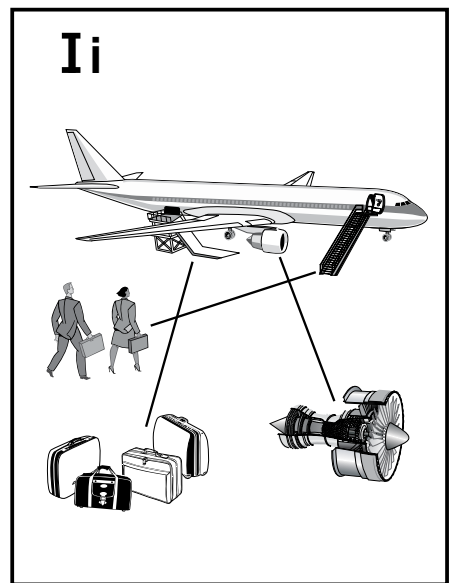
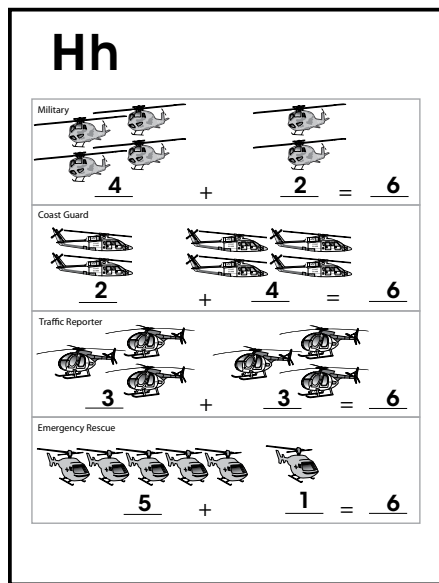
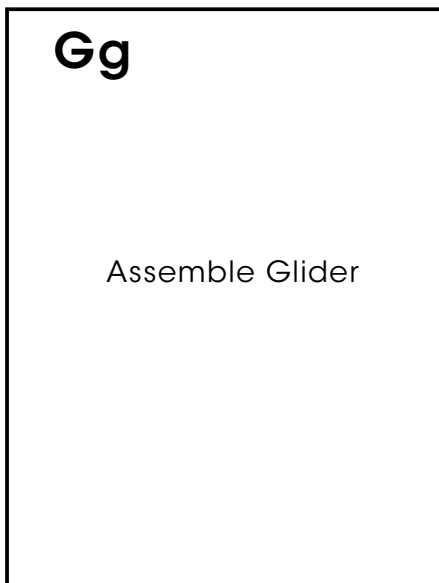
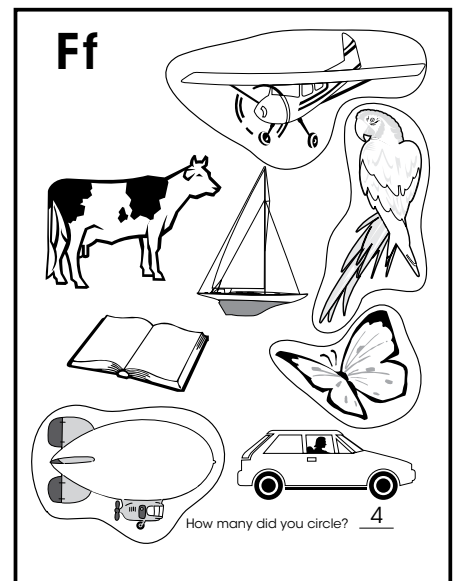
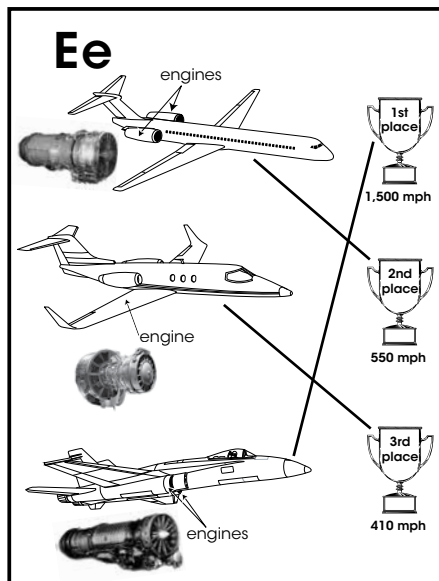
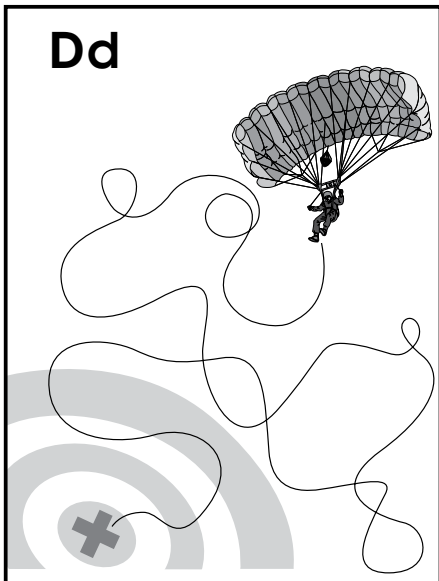
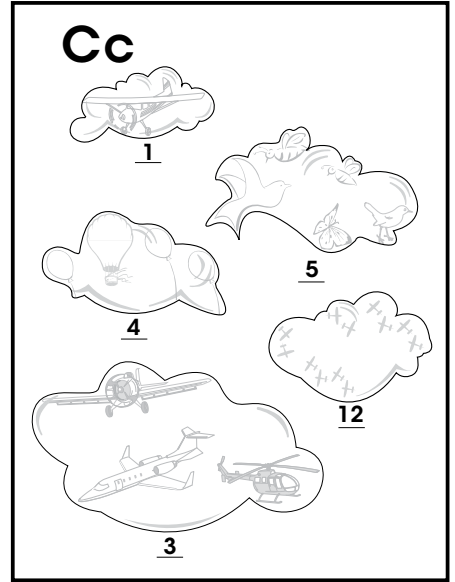
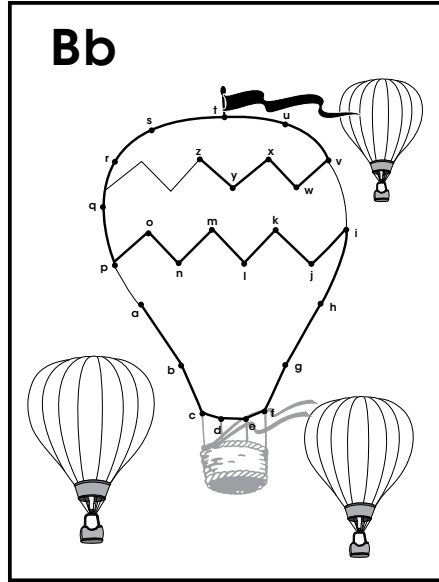
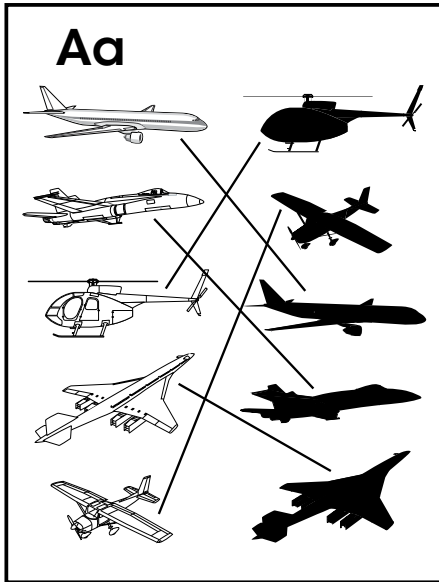

# Answer page

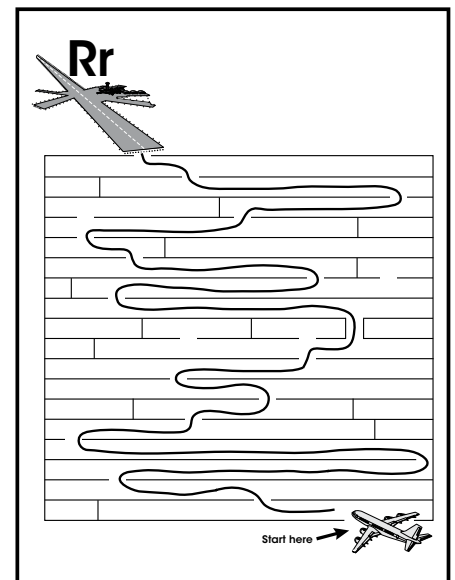
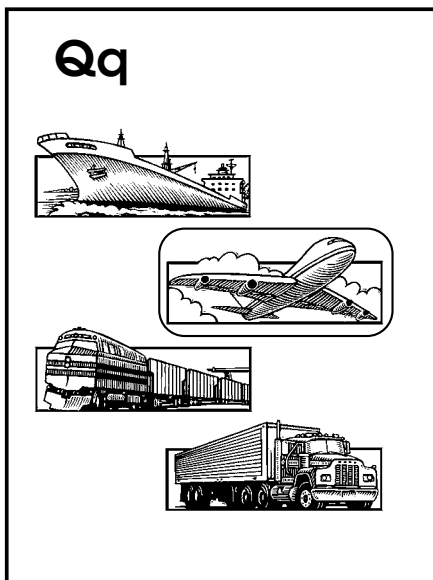
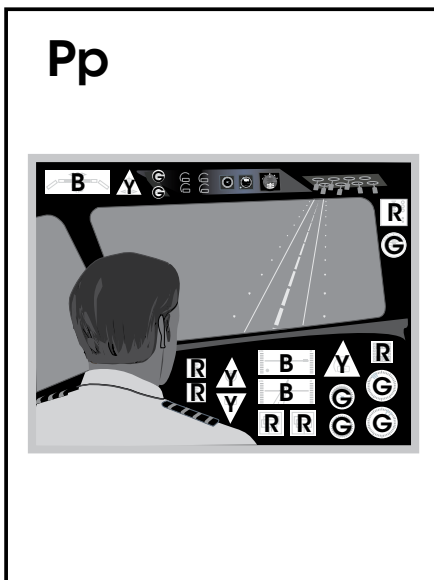
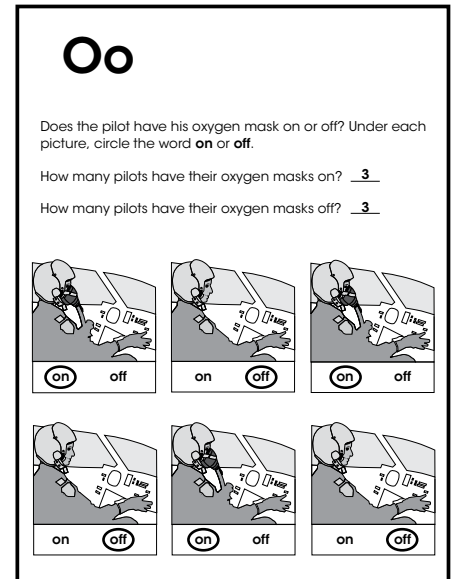
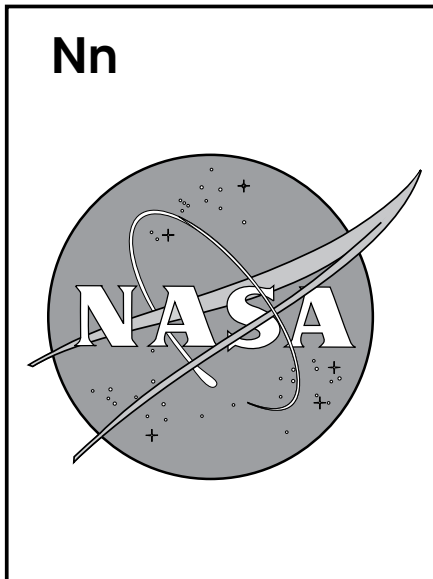
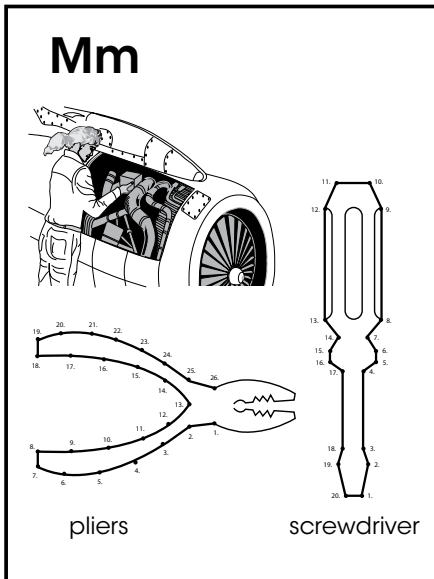
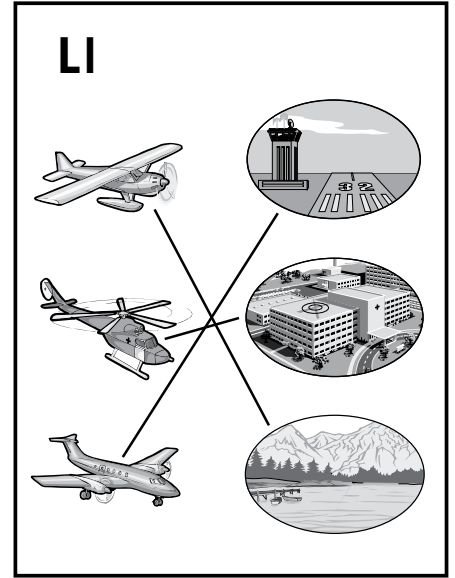
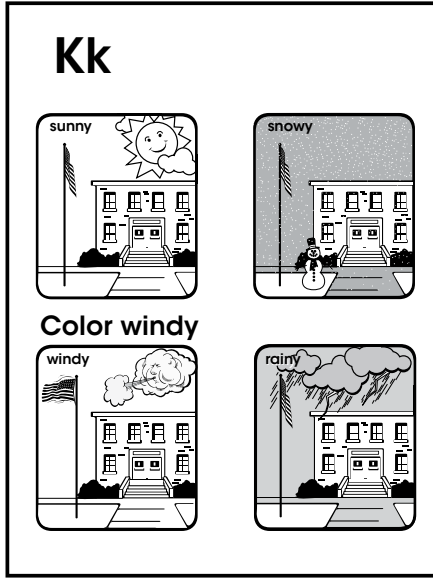
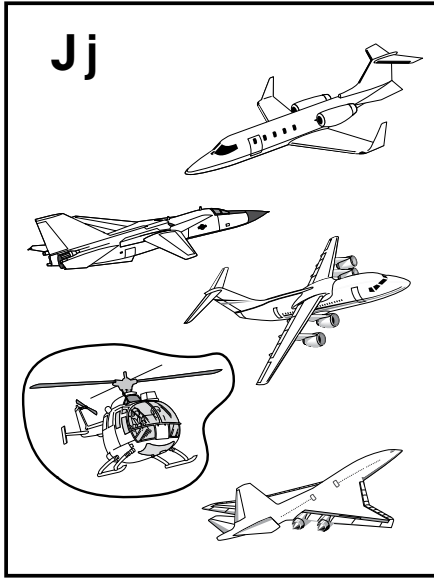







# Congratulations

on completing the

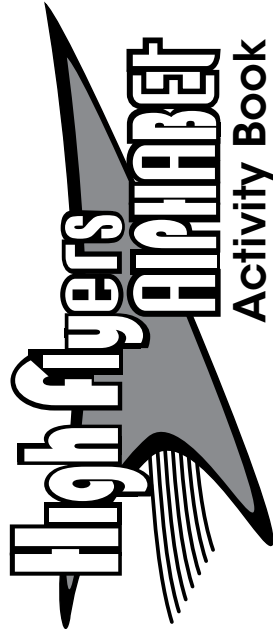

You have earned your wings as  
an honorary NASA pilot.

Four sets of horizontal lines for writing a name. Each set consists of a solid top line, a dashed middle line, and a solid bottom line.

Print your name on the lines above





# Glider

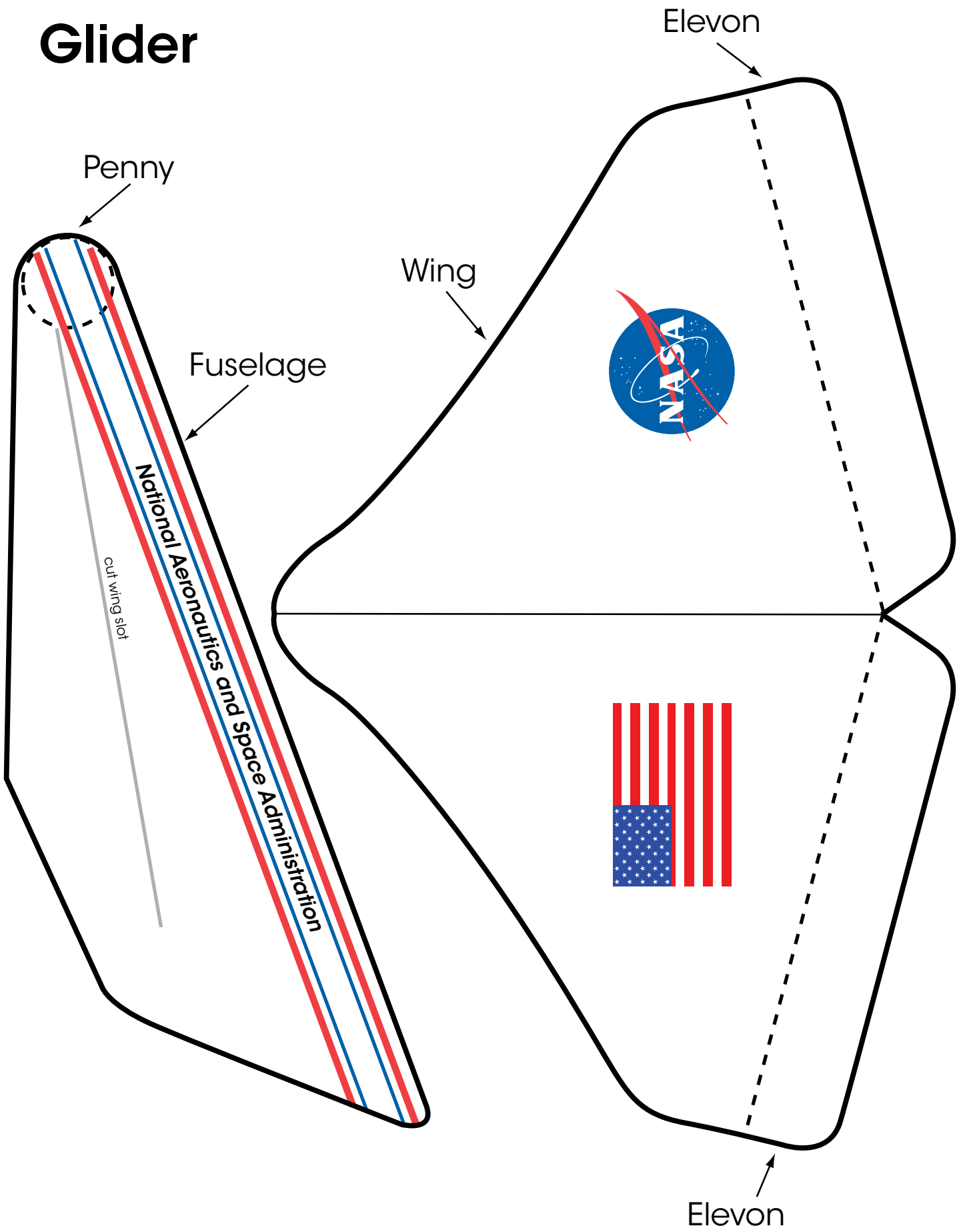

National Aeronautics and Space Administration

**Aeronautics Research Mission Directorate**

Washington, DC 20546-0001

<http://www.aeronautics.nasa.gov/education.htm>

<http://www.aeronautics.nasa.gov/>

**www.nasa.gov**

NP-2011-03-720-HQ