



N A S A
F U N P A D

PACKED WITH THINGS TO DO!



**EXPLORE
MORE**



For more information on NASA
and its outreach programs, visit
these web sites:

<http://education.nasa.gov>

http://www.nasa.gov/audience/for_kids

<http://stargazers.gsfc.nasa.gov>

<http://ksnn.larc.nasa.gov>

<http://kids.msfc.nasa.gov/>

DRAW A FACE ON THE SUN

Make it sad, mad or glad!

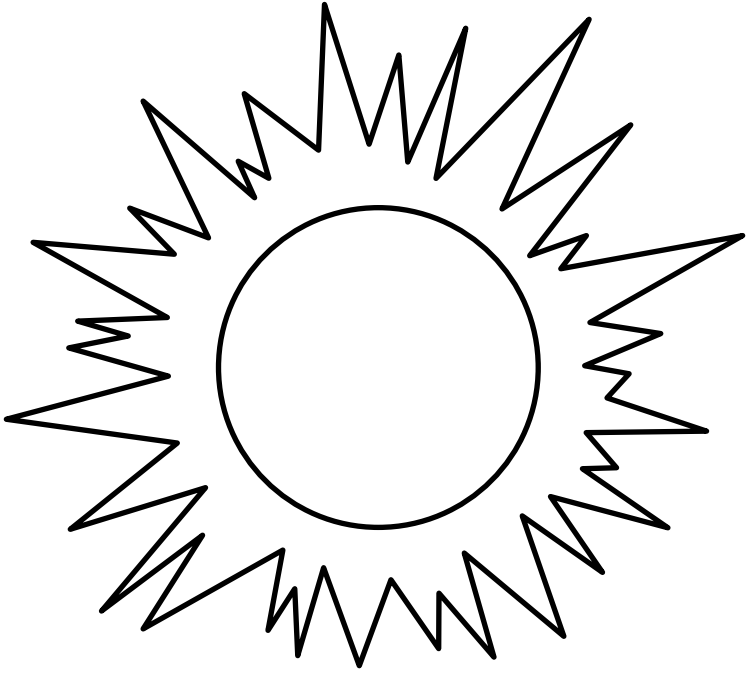

SAD

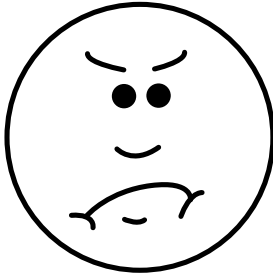

MAD

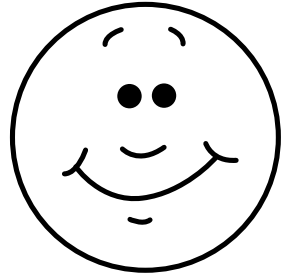

GLAD

FIND A WORD

Search for NASA words

Y R U C R E M A
I L A U N C H L
K S U N A R U N
M A R S U N E V
R T Z T **A** L C O
A U W **S** U N N D
L R **A** B P E E I
O **N** M I E A I O
S G U R W R C R
P L A N E T S E
B L T X E H P T
F O U M R A T S
A V O T F G C A
Y C Z M O O N R

✓ NASA
ASTEROID
COMET
EARTH

FLARE
LAUNCH
LUNAR
MARS

MERCURY
MOON
PLANET
PLUTO

SATURN
SCIENCE
SPACE
SOLAR

STAR
SUN
URANUS
VENUS

CONNECT THE DOTS

Look at space through this...

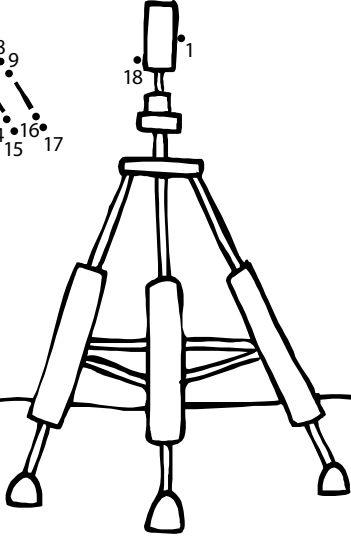
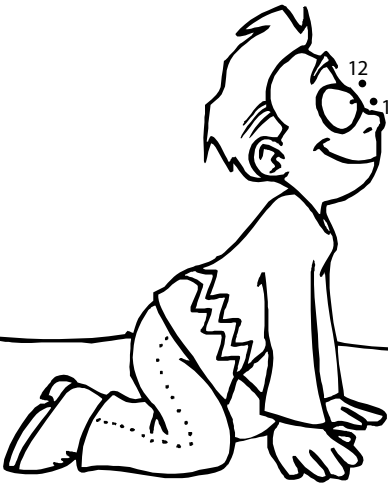
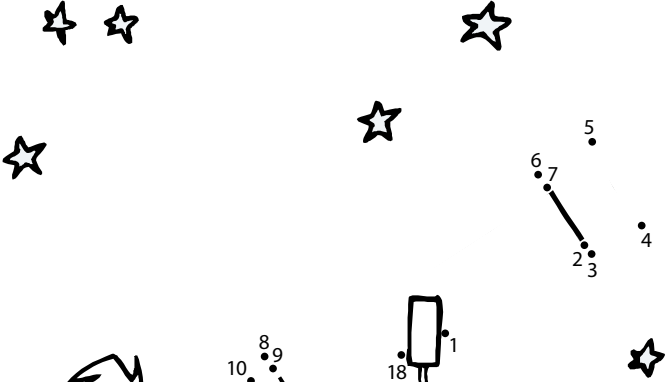

LAND ON THE MOON

*Maneuver through the maze
for a safe landing*

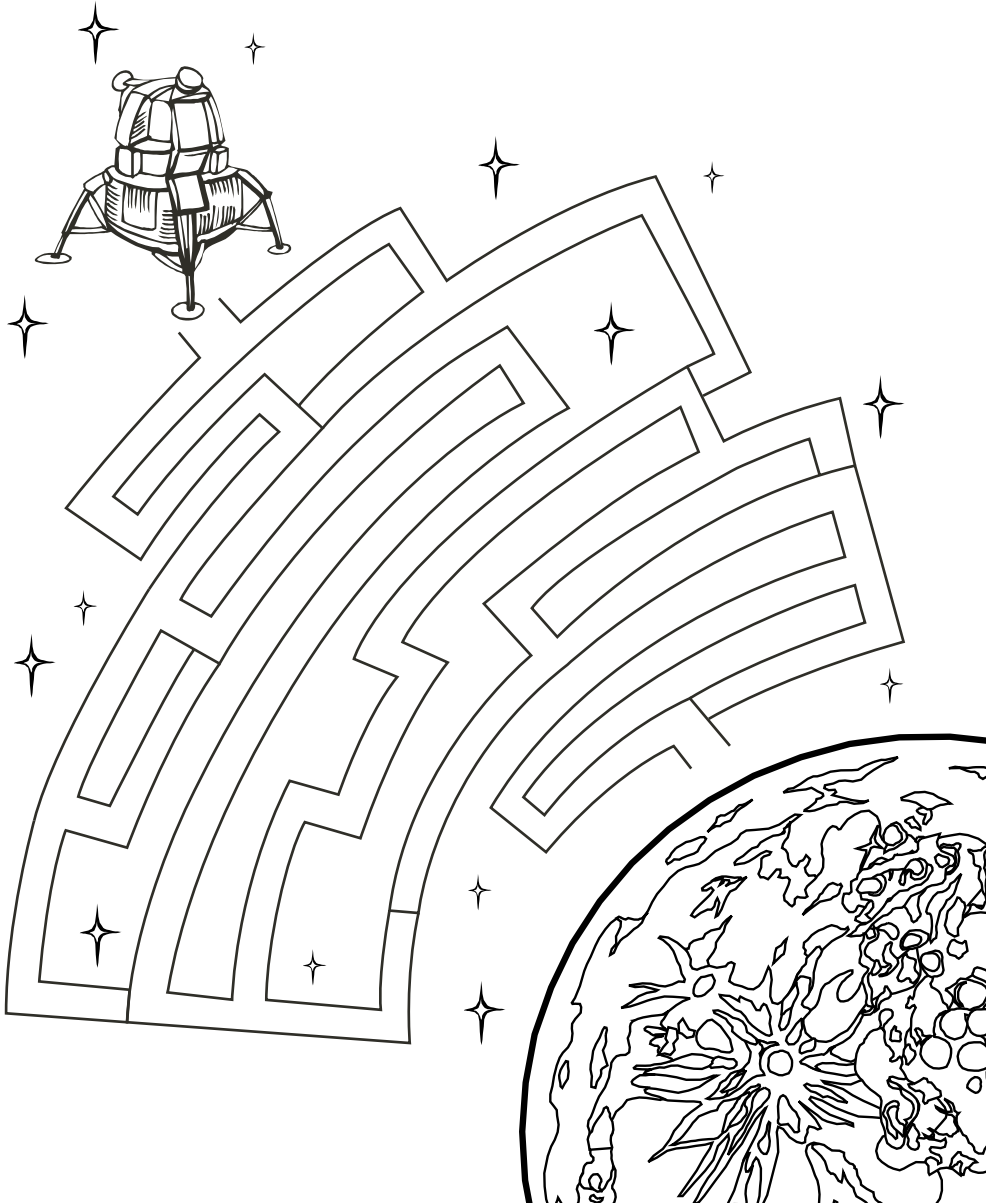

FIND THE DIFFERENCES

Look closely for 6 different things

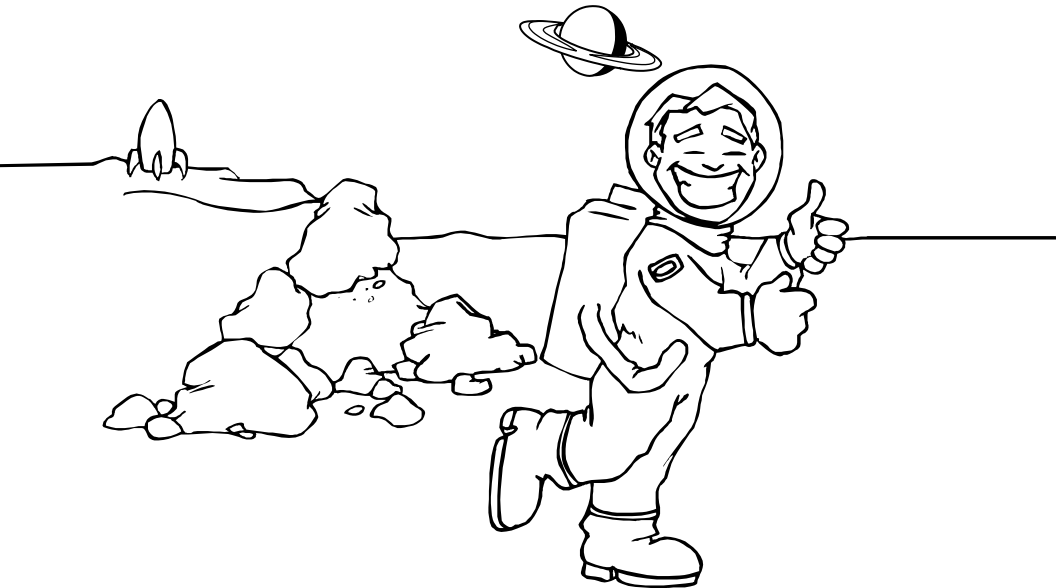

COLOR THE HST

Hubble Space Telescope

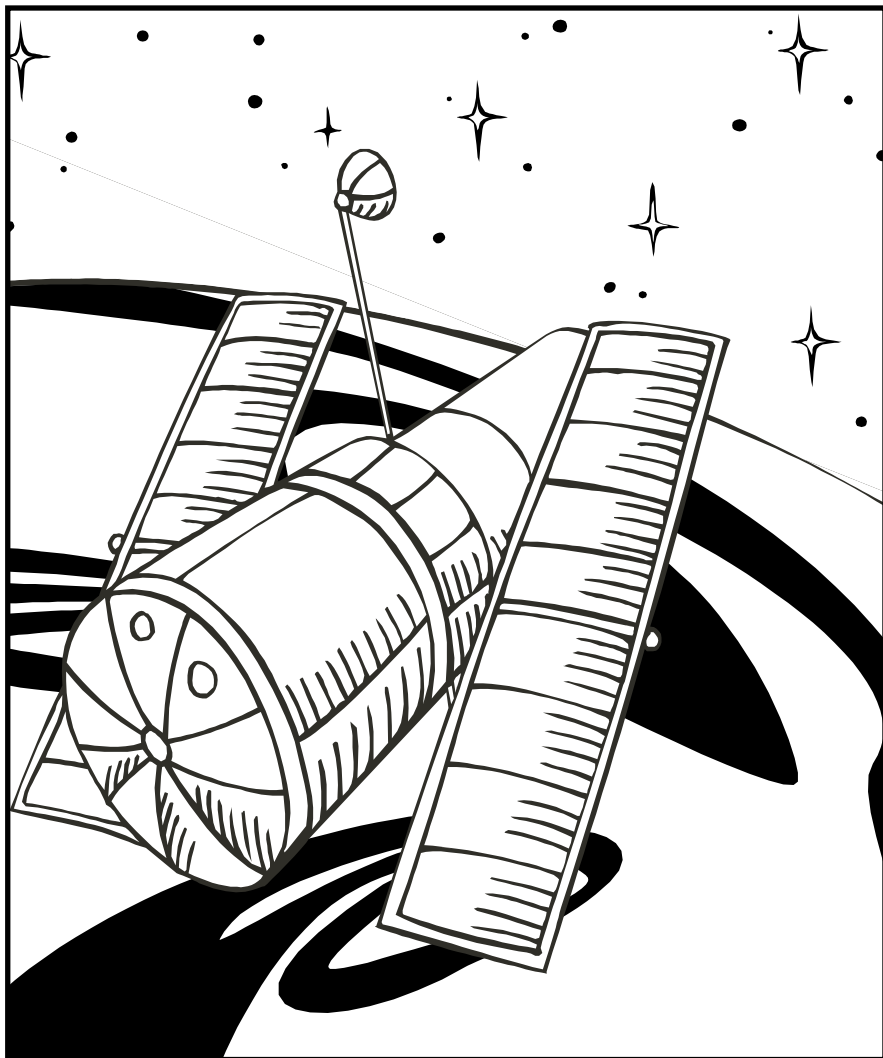

SPACE CROSSWORD

Universal appeal

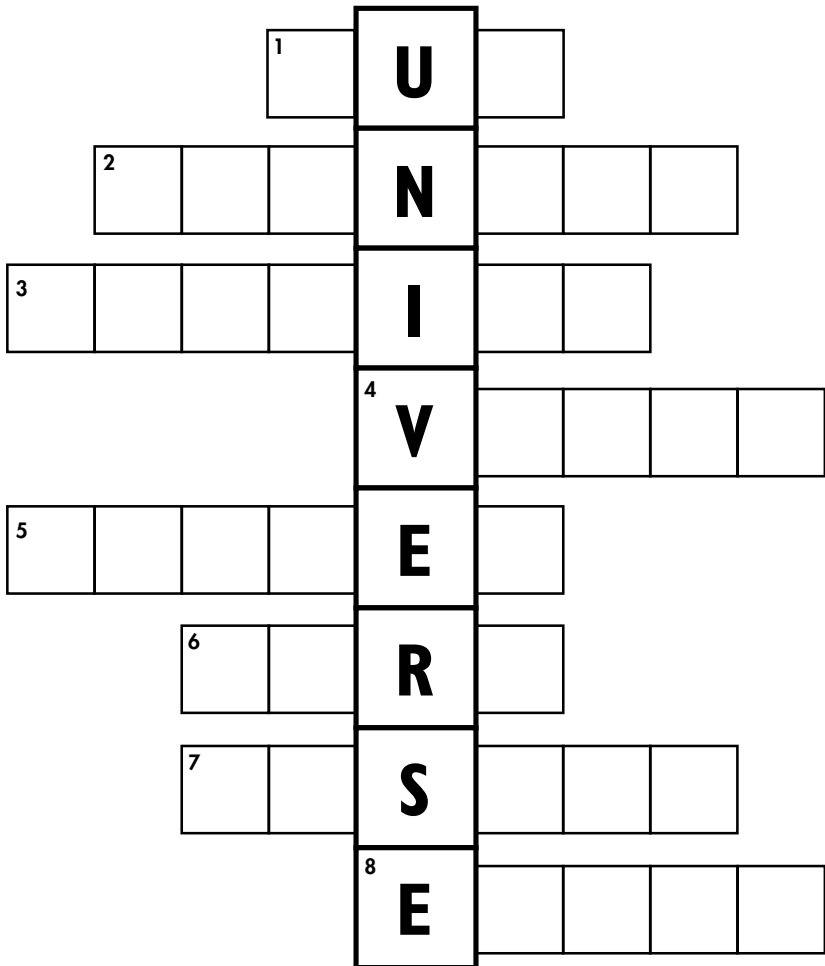

CLUES:

1. Our central, brightest star
2. Eight _____ revolve around the Sun
3. This keeps us on Earth
4. Second planet from the Sun
5. Launch vehicle
6. The "red planet"
7. Eight planets make up our solar _____
8. Our home planet

FIND THE SHAPES

Where are these shapes?

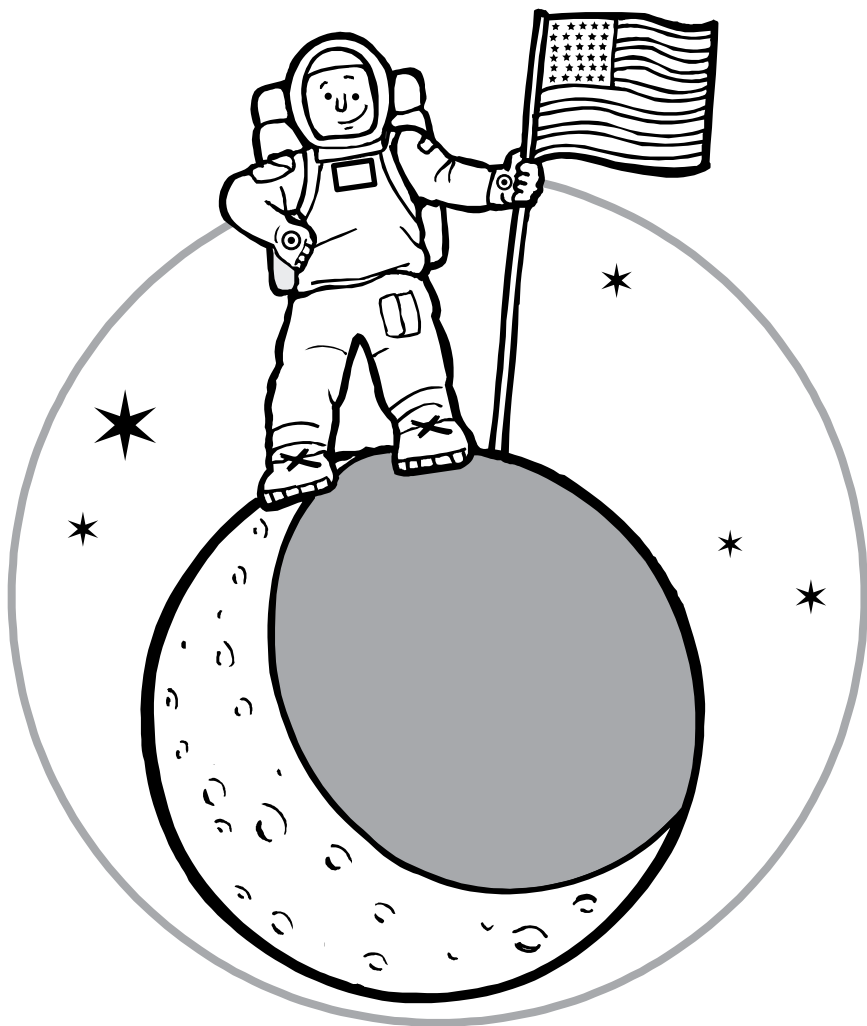

NAME THE PLANETS

How to remember...



My
Very
Educated
Mother
Just
Served
Us
Nachos

Mercury
Venus
Earth
Mars
Jupiter
Saturn
Uranus
Neptune

COLOR MY WORLD

Color-by-Number Moon Dog

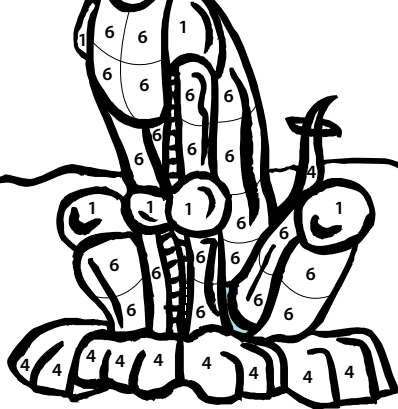
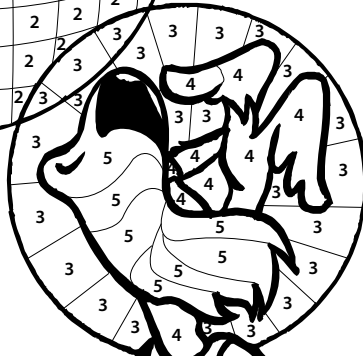
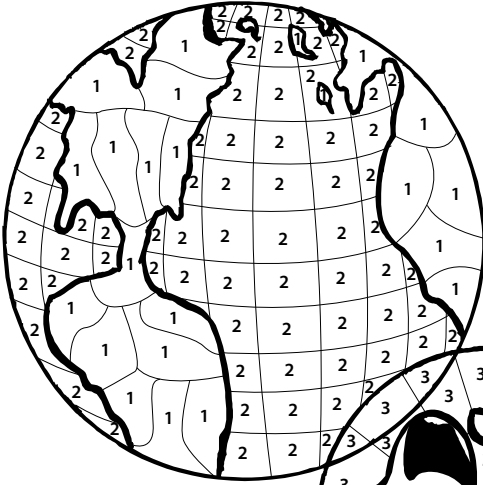

- 1 - Green
- 2 - Blue
- 3 - Light Blue
- 4 - Brown
- 5 - Tan
- 6 - Light Green



SUN FUN FACTS

Read the facts and color the Sun

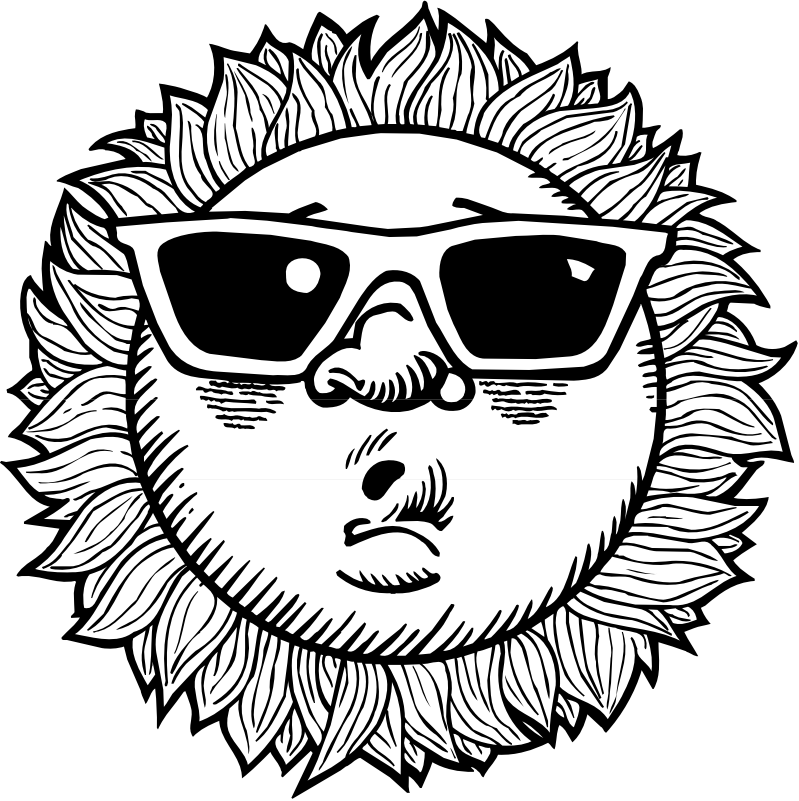

The Sun is the star closest to the Earth so it looks very bright and large, even though it is 93 million miles away.

Energy released by very hot gases in the Sun's center travels out into space and gives Earth its heat and light.

The Sun is the center of our Solar System. All of the planets in the Solar System travel around the Sun in paths called orbits.

GEMINI – THE TWINS

*Draw stars over the circles and
make a star constellation*

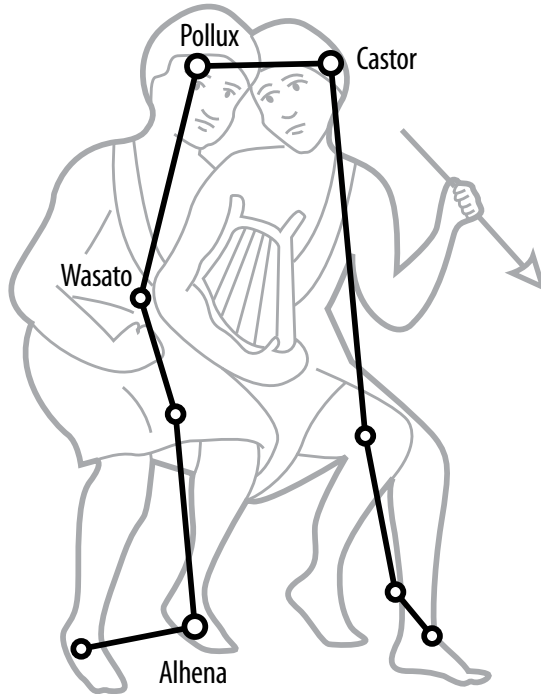

Gemini is easy to find as it is high overhead in mid-winter, above and to the left of Orion. It's two brightest stars — Castor and Pollux — represent the mythological twin brothers of Helen of Troy.

Pollux is the brighter of the twins. It's an orange-giant star that's about 35 light-years from Earth. Castor consists of six stars. This crowded system lies about 50 light-years from Earth.

IDENTICAL SATELLITES?

Which satellite is different?

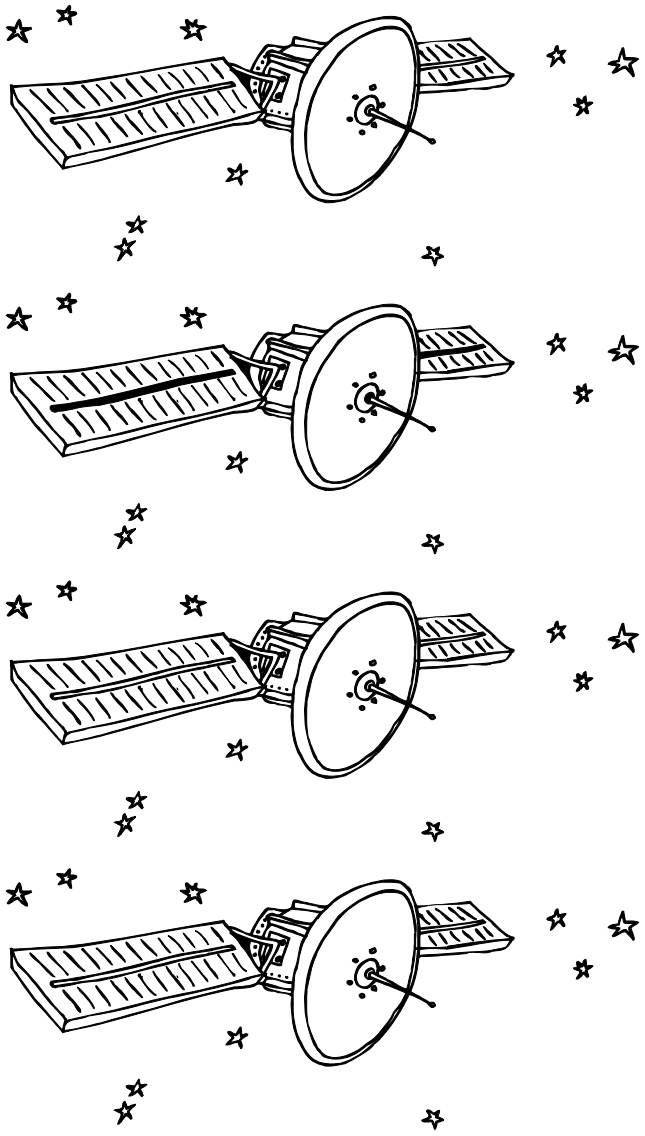

LIFE LINE

Pick the line that will help the astronaut get back to the Shuttle



FINISH THE SPACE STATION

Draw over the dotted lines and color

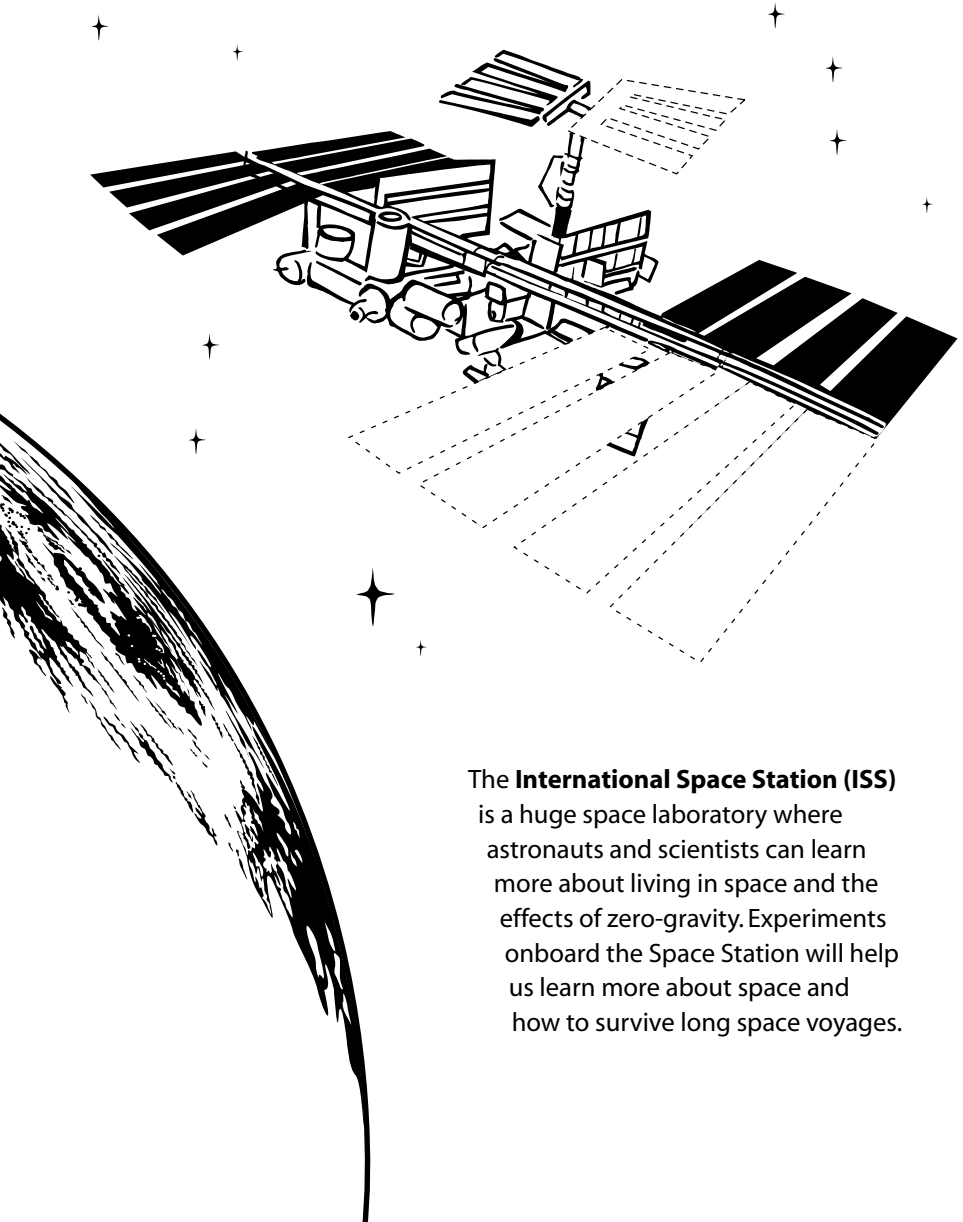

The **International Space Station (ISS)** is a huge space laboratory where astronauts and scientists can learn more about living in space and the effects of zero-gravity. Experiments onboard the Space Station will help us learn more about space and how to survive long space voyages.

TOGETHER FOREVER

Draw lines between the objects that go together

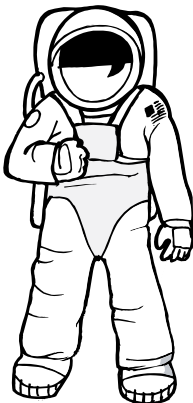
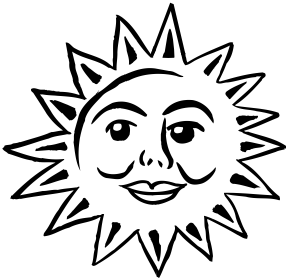
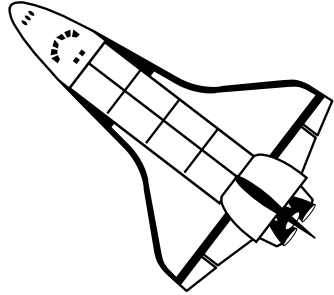
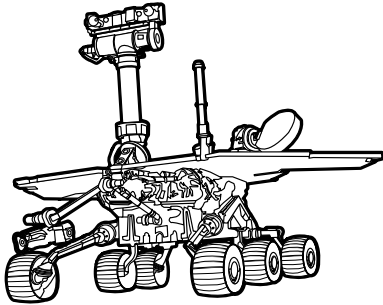

SPELL MORE WORDS

How many words can you spell using the letters in SOLAR SYSTEM?

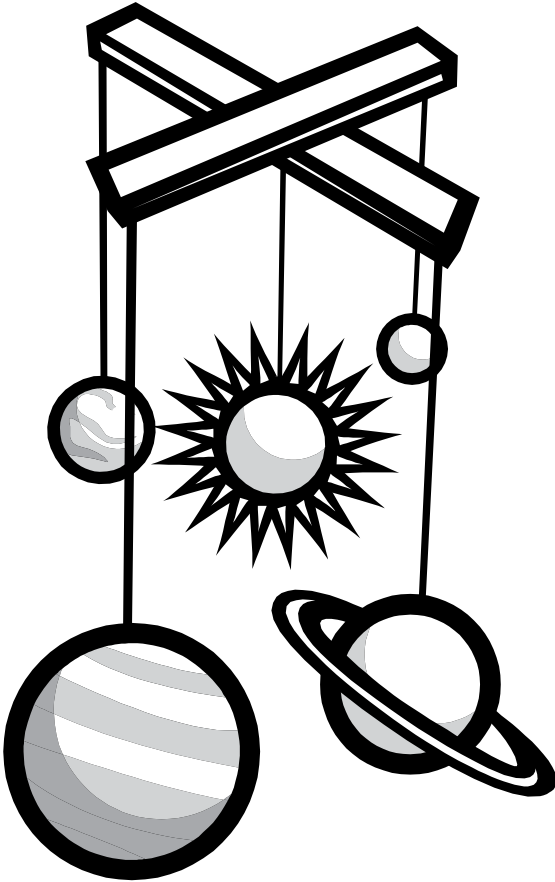

1. _____

2. _____

3. _____

4. _____

5. _____

6. _____

7. _____

8. _____

9. _____

10. _____

MISSION PATCH

Connect the Dots



STS-51G Shuttle Mission - Launched in 1985

The crew included French, Saudi Arabian and American astronauts. Three communications satellites were deployed (MORELOS-A for Mexico, ARABSAT-A for the Arab Satellite Communications Organization, and TELSTAR-3D for the USA). Communication satellites are used for many purposes on Earth including TV, radio, telephone, and pagers.

FINISH THE SHUTTLE

Use the dotted lines and boxes to finish the other half of the Shuttle.

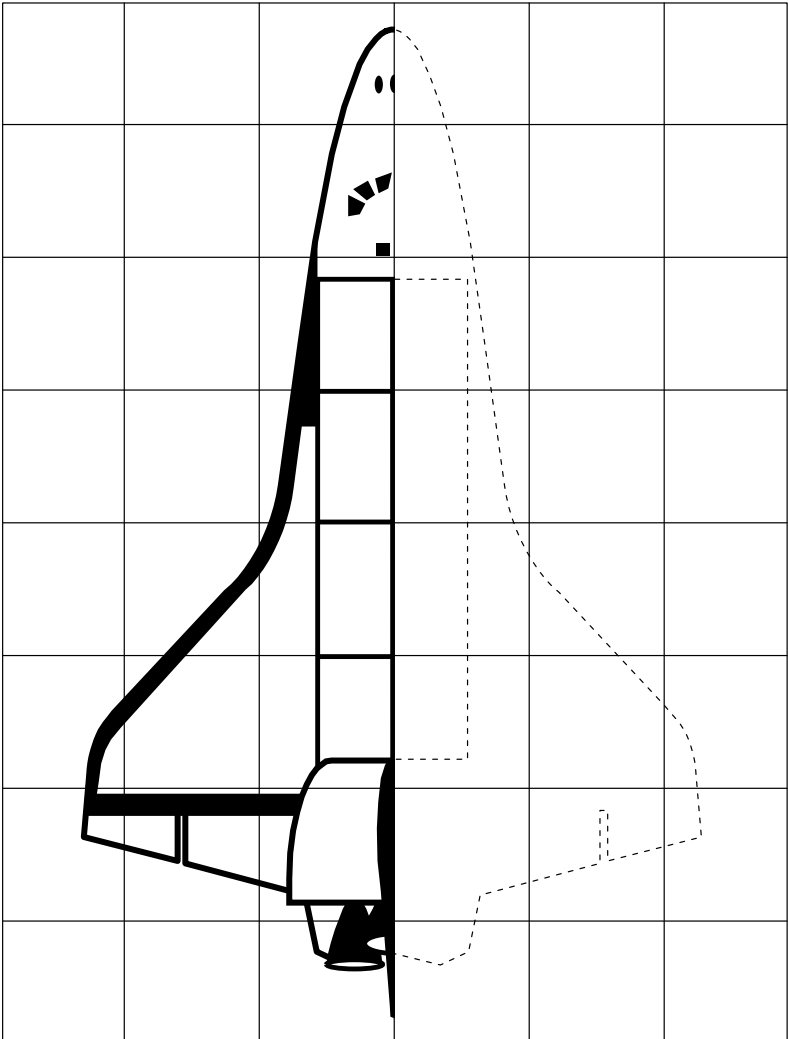

UNSCRAMBLE THE WORDS

Help the astronaut work on these things

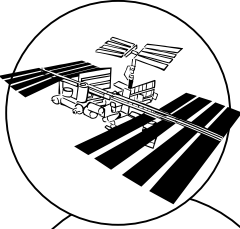

CAPES TOSITAN

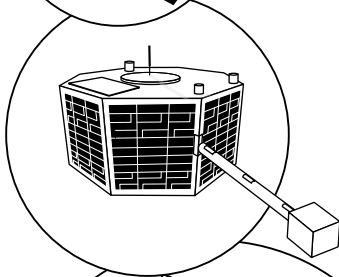

LAITELSTE

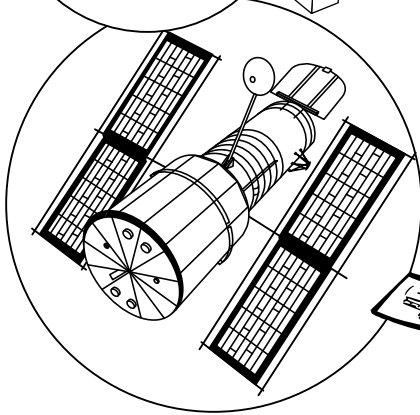

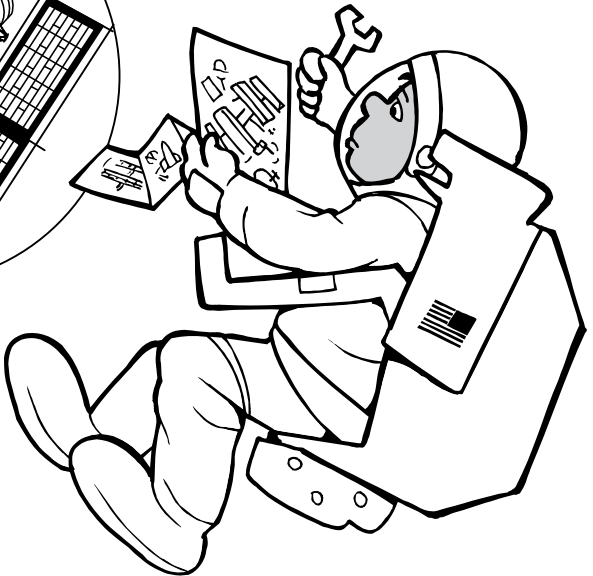

UBEBHL

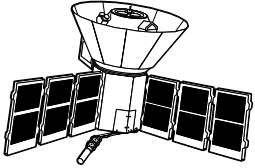
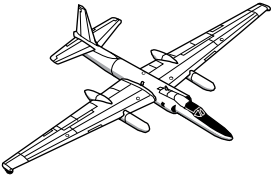
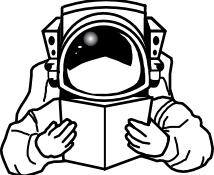

WHAT DOES NASA EXPLORE?

Find the answer by writing the first letter of each object in the box beside the picture

FIND A WORD

Search for NASA words

N E P T U N E H S T A S D
E S P I L C E P H C A M E
E L B B U H R M U L Y I W
A S T R O N A U T I A L E
S H N O A S G A T E R K L
U A D A S T G A L A X Y O
N R O V E R S A E S U W H
S E L O H K C **A** L B K A M
P M B N D S L O **I** I D Y R
O P J U P I T E R **R** L B O
T H I K L S Y G R E N E W
O L L O P A C I M S O C O

✓ AIR

APOLLO

ASTRONAUT

ATLAS

BLACKHOLE

COSMIC

ECLIPSE

ENERGY

GALAXY

GALILEO

HUBBLE

JUPITER

MACH

MASS

MILKY WAY

NEBULA

NEPTUNE

NOVA

ORBIT

ROVER

SCALE

SHUTTLE

SKY

STAR

SUNSPOT

WORMHOLE

XRAY

ASTRONAUT COLOR BY NUMBER

Help the astronaut place the flag

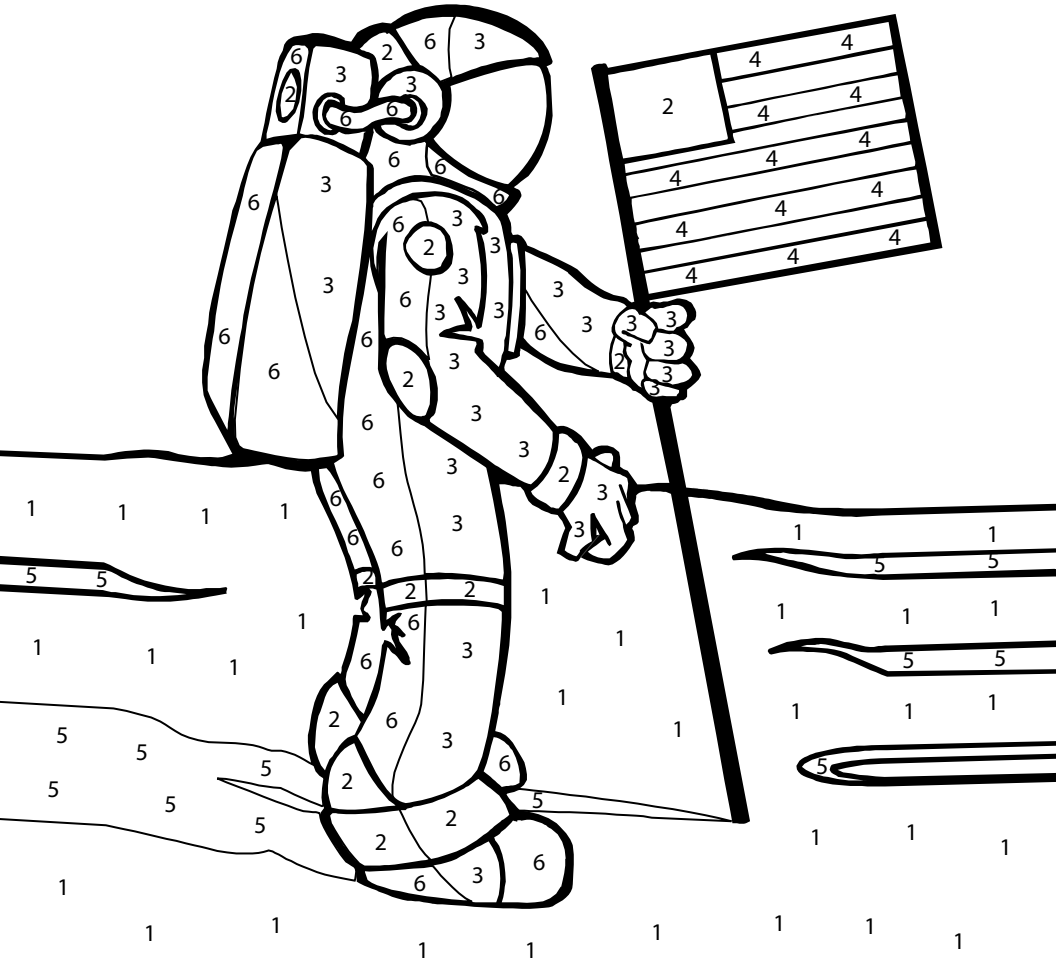

1 - Tan
2 - Blue

3 - Gray
4 - Red

5 - Brown
6 - Dark Gray

UNSCRAMBLE THE WORDS

What can you see through a telescope?

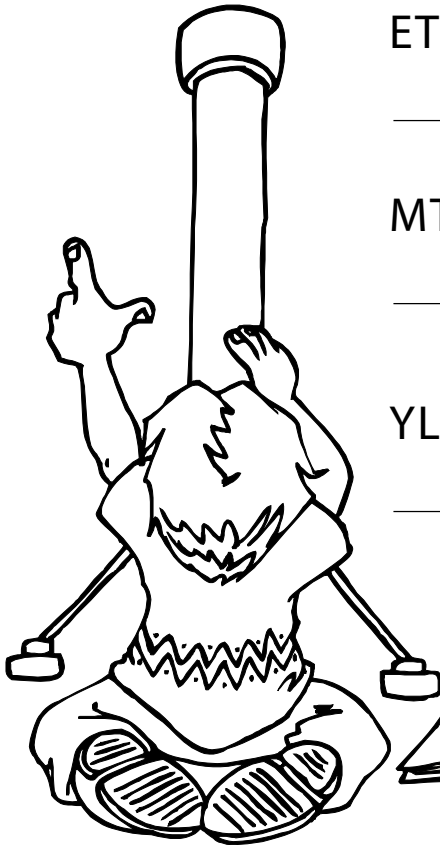
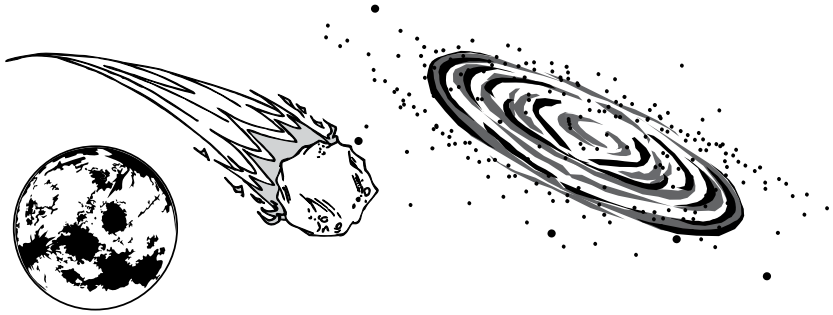

ETPNAL

MTEOC

YLAGAX

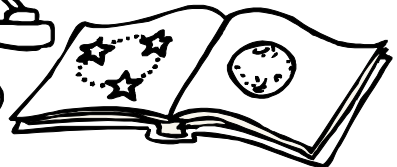

RHYME TIME

What other words rhyme with *SPACE*?



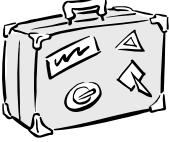









WHICH ONE IS DIFFERENT?

Find the astronaut that is not the same

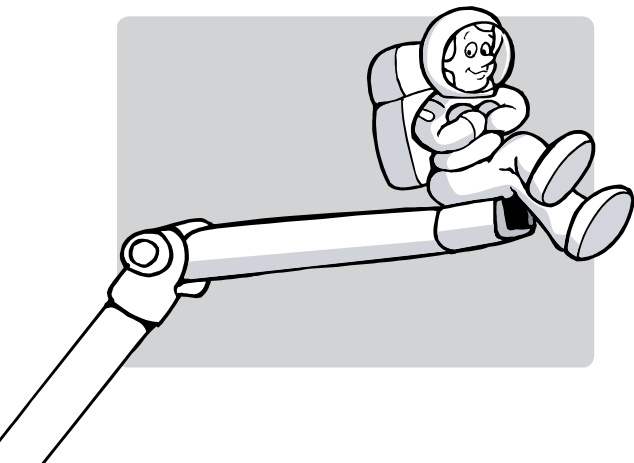
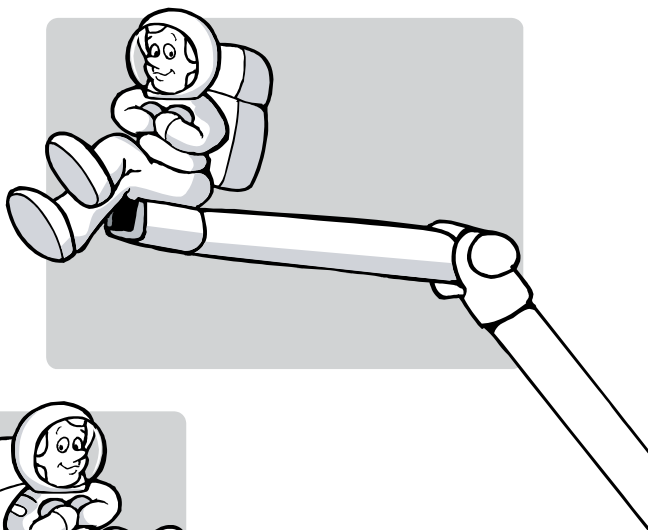
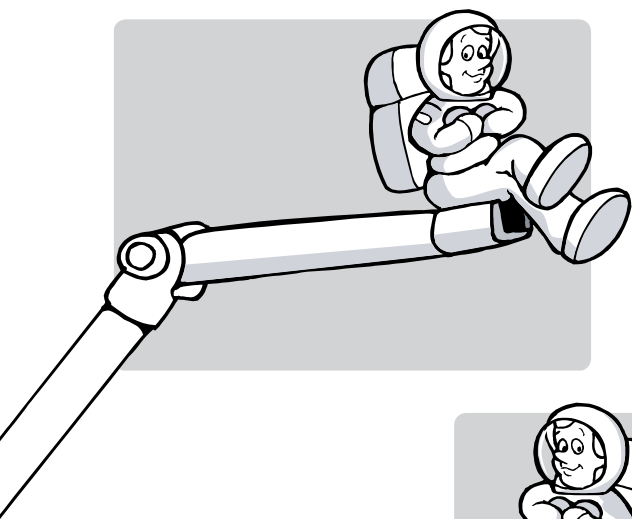

FIND THESE SHAPES

Circle the objects in the picture



CONNECT THE DOTS

What planet is this?

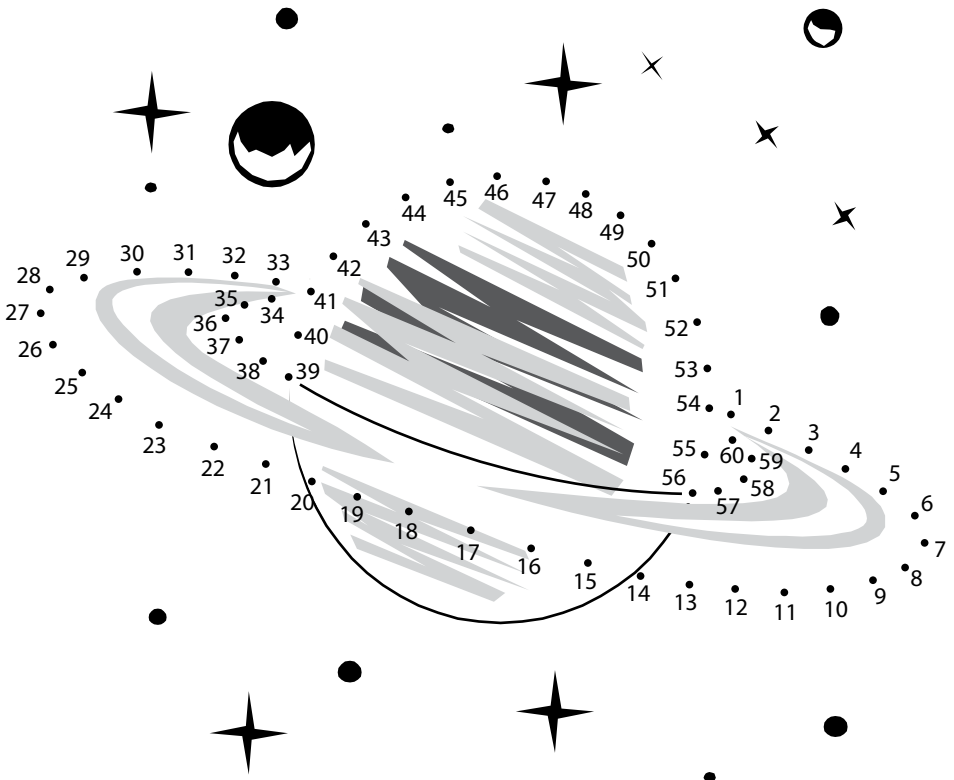

This planet is sixth from the Sun and the second-largest planet in our solar system. When the Pioneer and Voyager spacecraft missions visited the ringed planet, we found out that the rings are a complex system of many individual rings, each made up of countless pieces of ice and rock.

SUN SHADOW MATCH

Match each Sun to its shadow

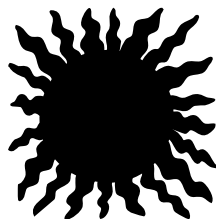
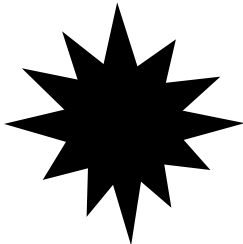
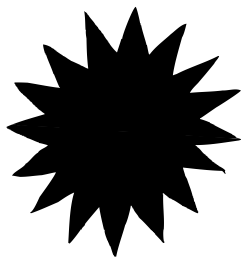
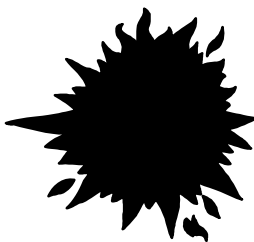
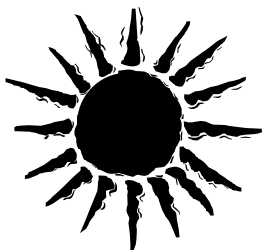
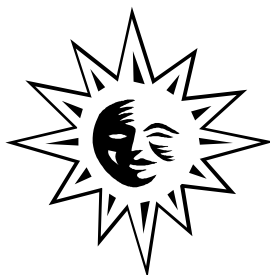
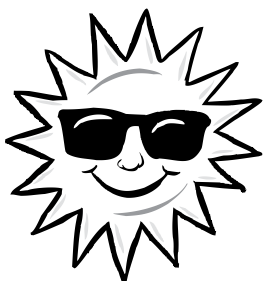
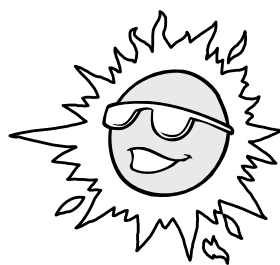
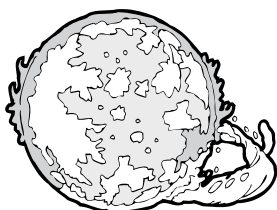
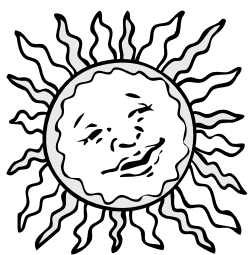

WHAT IS MISSING?

*The Mars Rover on top is correct.
Draw in the missing pieces on the other
Rover to make it complete.*

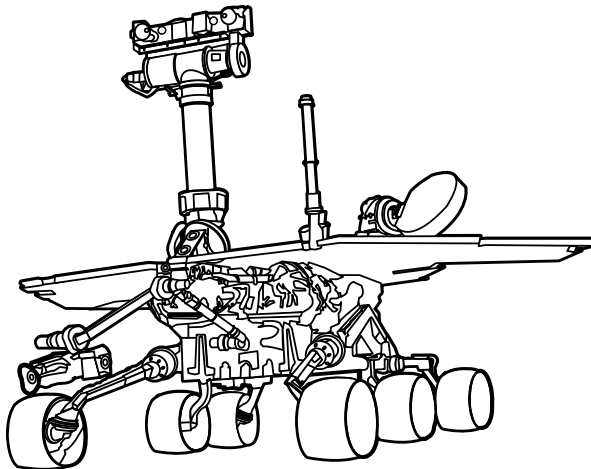
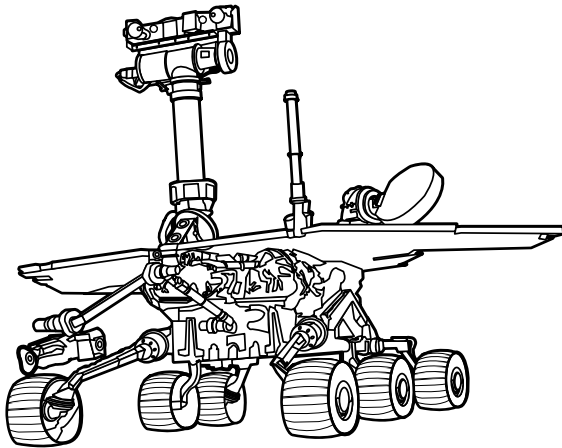

LEO – THE LION

Draw stars over the circles and make a star constellation

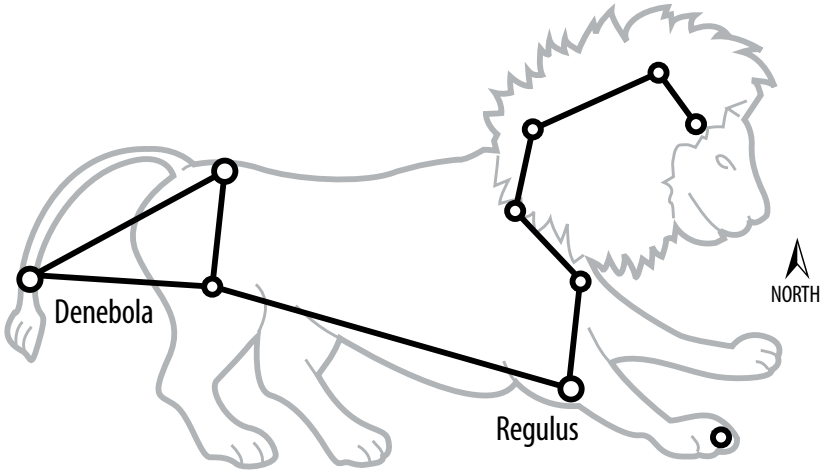

The zodiacal constellation Leo, the lion, is one of a handful of constellations that really does look like its namesake. Look for Leo high in south sky in April and May.

Leo's brightest star is blue-white Regulus, one of the brightest stars in the night sky. Once Regulus climbs into the sky, look to its left — toward the north — for a group of stars forming a backward question mark. These stars outline Leo's head and mane.

About two hours later, look low in the east sky for Leo's tail — a white star named Denebola — an Arabic name that means "tail of the lion."

STAR COUNT

How many stars can you count?

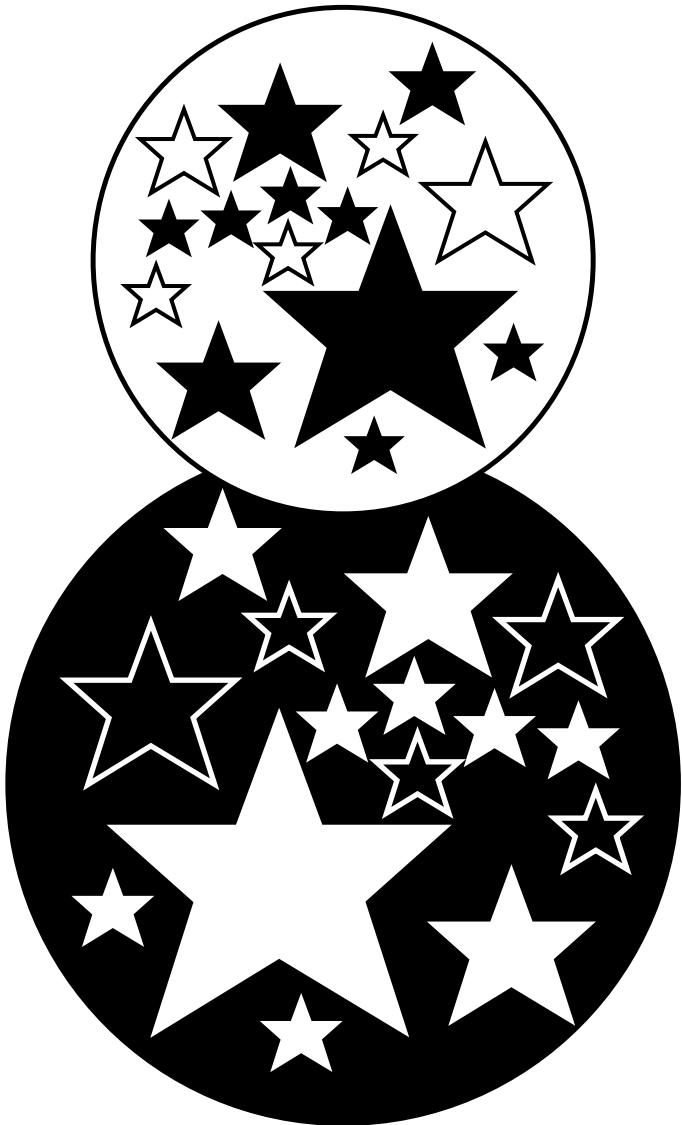

NASA QUIZ

What does NASA mean?

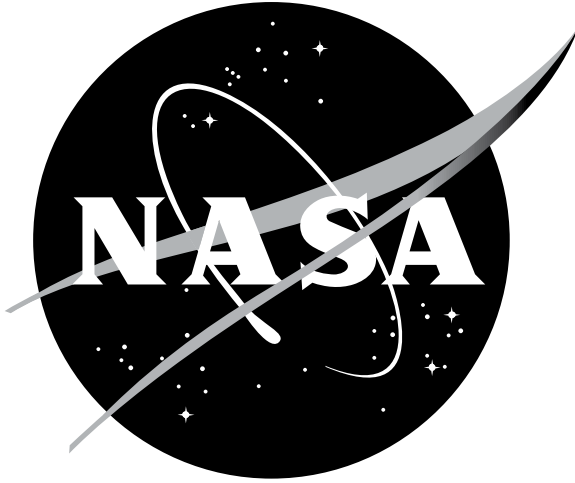

N _____

A _____

S _____

A _____

Since 1958, NASA has accomplished many great scientific and technological feats in air and space. Our exploration of space has taught us to view Earth, ourselves, and the universe in a new way. NASA is a leading force in scientific research, sparking public interest in aerospace exploration, and developing new technologies.

IN-SPACE COLORING

*Science experiments on the
International Space Station*



The International Space Station is being used to study how the human body adapts and responds to long-term space flight.

These studies include how bones and muscles respond and how physical exercise can change those responses.

Studies are also being performed on the effects of radiation from the Sun on the human body.

NASA AT WORK

Can you guess what these people do?
Unscramble the clues.

GENENINRE



SIGOBOTIL

GITFLH
TORECRID



TIESINCIT

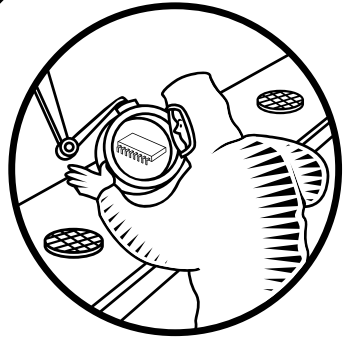

CINATHECIN

DR. ROBERT GODDARD

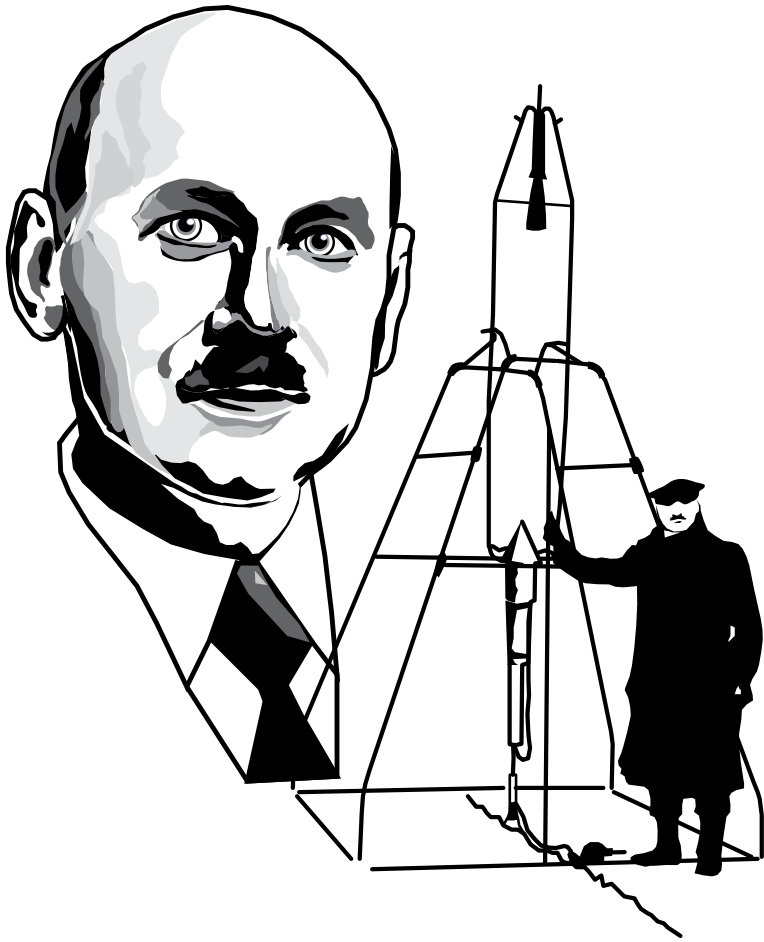

Dr. Robert H. Goddard successfully launched the first liquid fueled rocket in Auburn, Massachusetts on March 16, 1926. NASA Goddard Space Flight Center in Greenbelt, Maryland is named after him and for his pioneering spirit in rocketry .

DEEP SPACE NETWORK

Space antennas at three sites

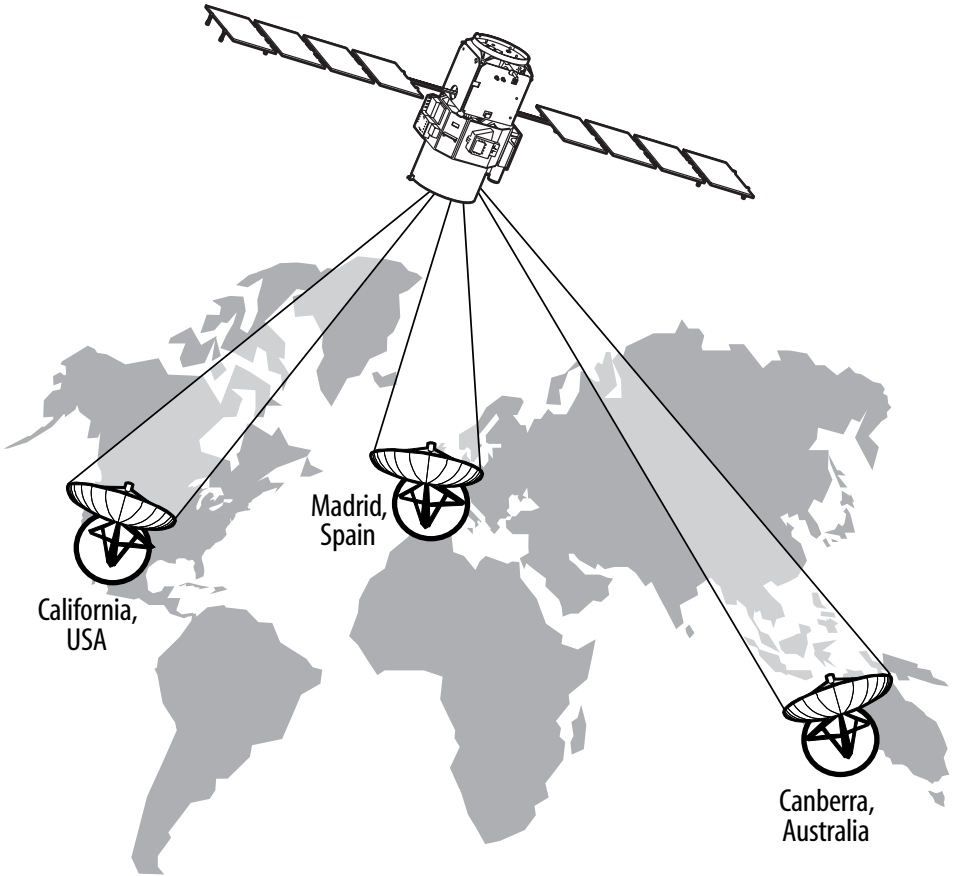

This world map shows the three locations of the Deep Space Network's antennas. As Earth rotates on its axis, a spacecraft out in space will be able to "see" at least one set of antennas. Each of the three locations has several antennas for tracking different spacecraft at the same time.

COMPUTER WORK

Computers are very important tools for studying space.

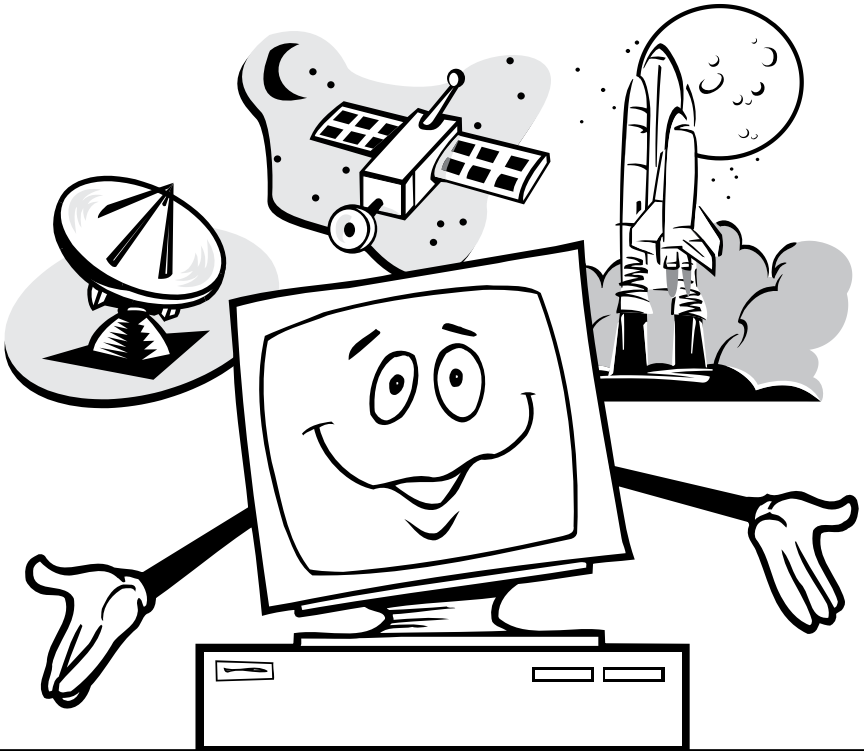

Computers are used to write programs that control spacecraft and their science instruments. They are used to help test instruments before they are launched and for communication. Computers are used to study space data and to produce the amazing images that we see from space. They are also used to help pass this information on to the world through the internet.

LIVING ON THE MOON

Draw a picture of a lunar base

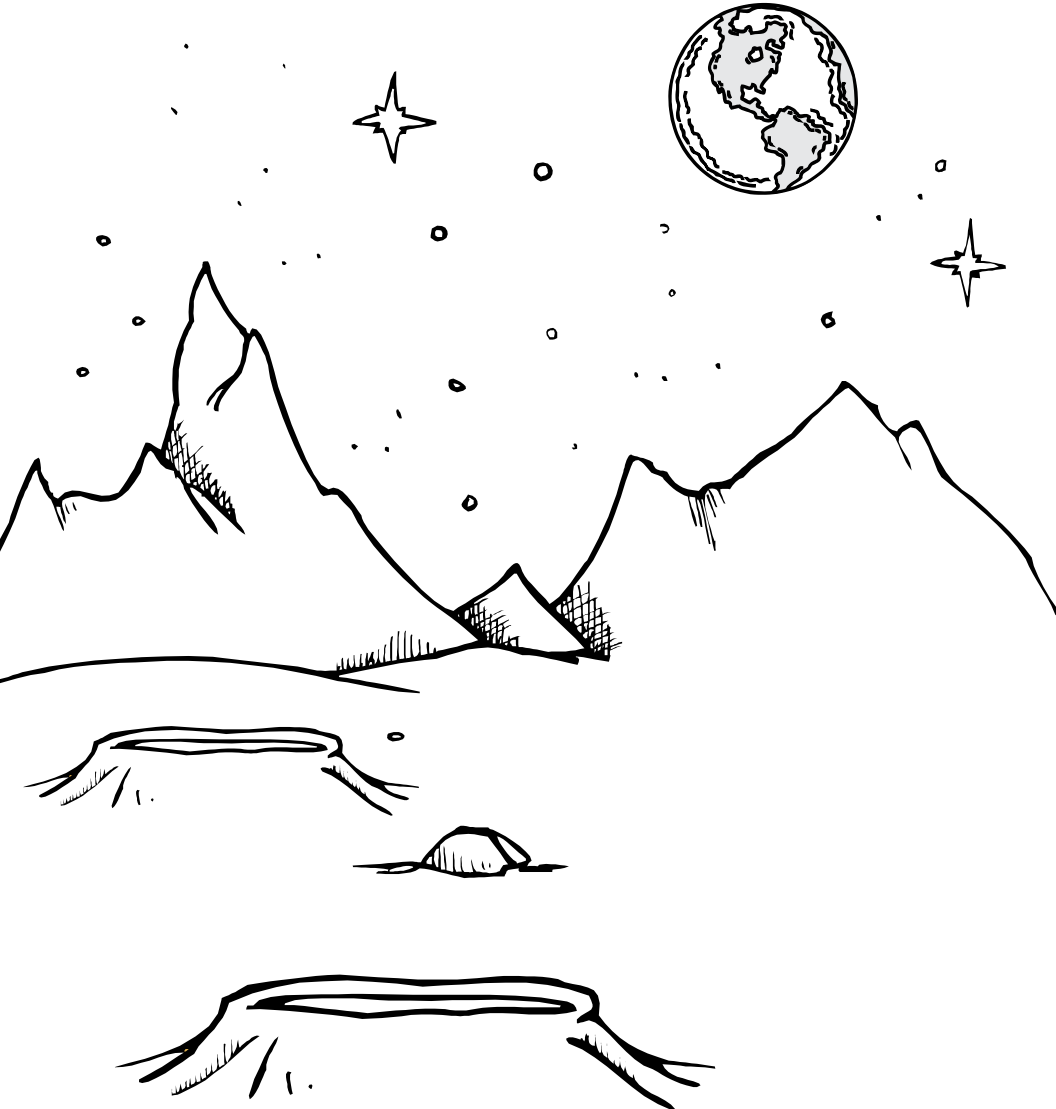

WHAT IS DIFFERENT?

Find and circle 10 different things

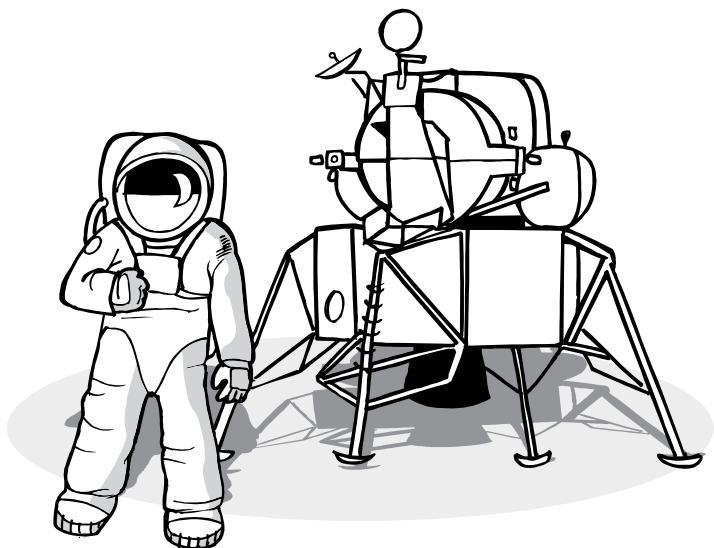
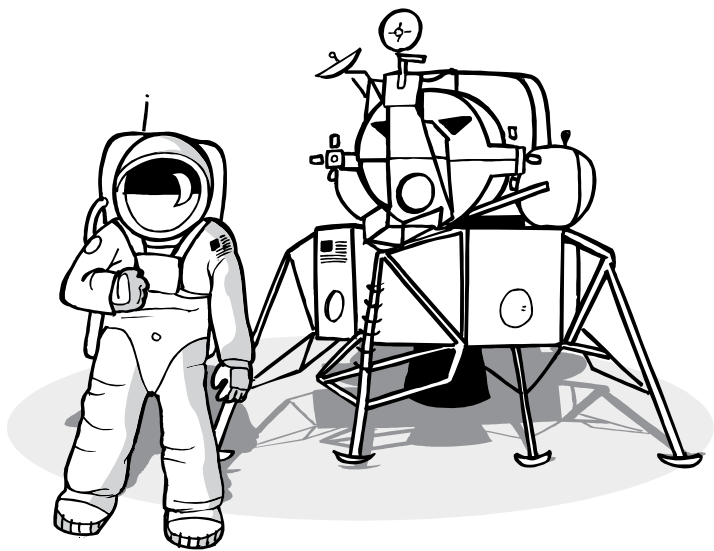

IMPORTANT SATELLITES

Color the ST5 and SDO satellites

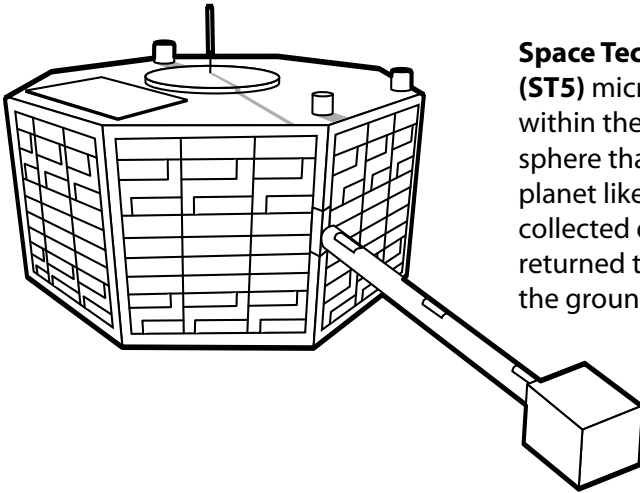

Space Technology 5 (ST5) micro-sats flew within the magnetosphere that surrounds our planet like a shield. The collected data has been returned to scientists on the ground for analysis.

Solar Dynamics Observatory (SDO)

(SDO) was launched in 2010. It is helping us understand the source of the Sun's energy. It is providing the scientific understanding that will help us improve the quality of forecasts of solar activity.

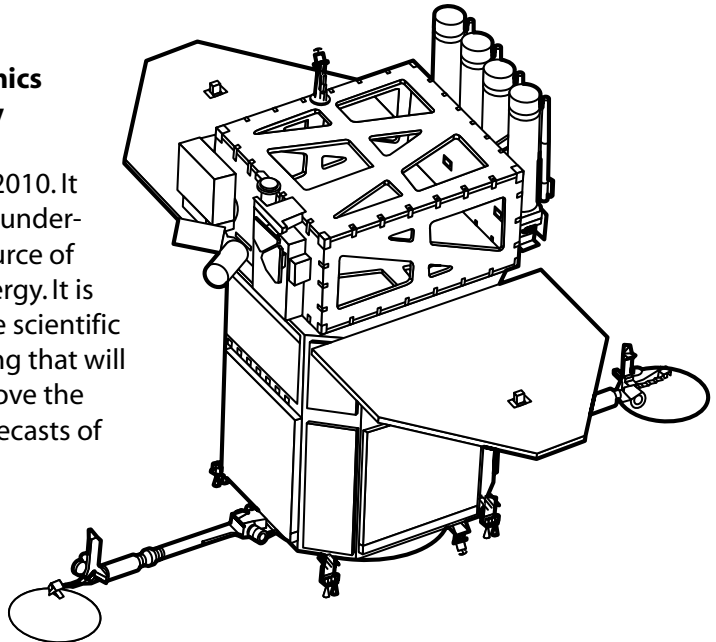

HIDDEN ROCKETS

Find and circle 5 rockets that are shown on the right

Besides the Space Shuttle, NASA uses different rockets to launch satellites, probes, and other science equipment into space.

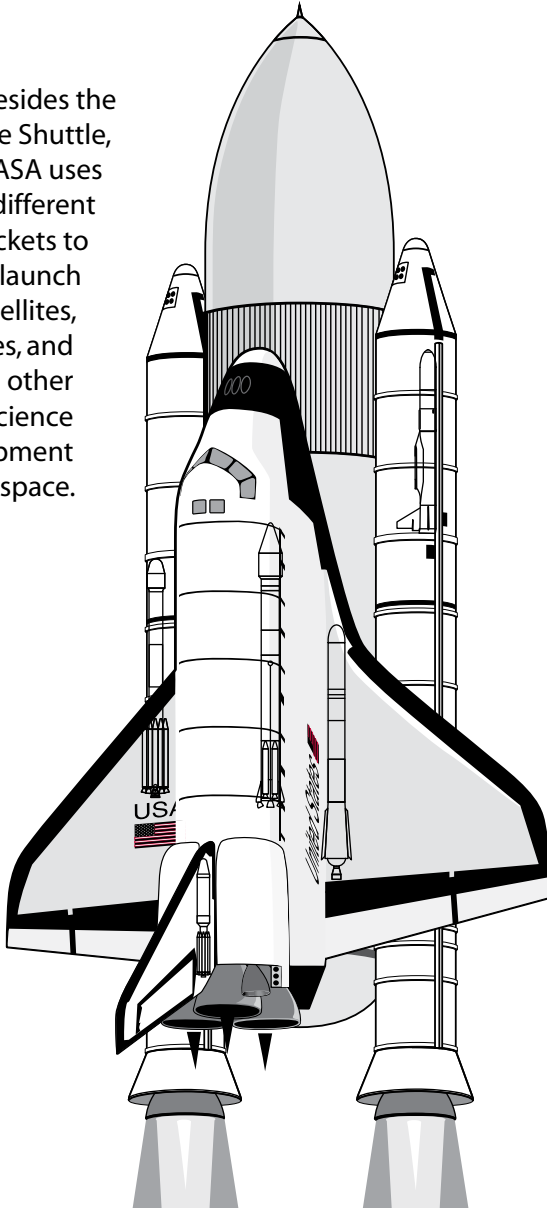

PEGASUS

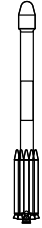

DELTA II

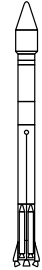

ATLAS II



TITAN II



DELTA III

CROSSING WORDS

Space rocks

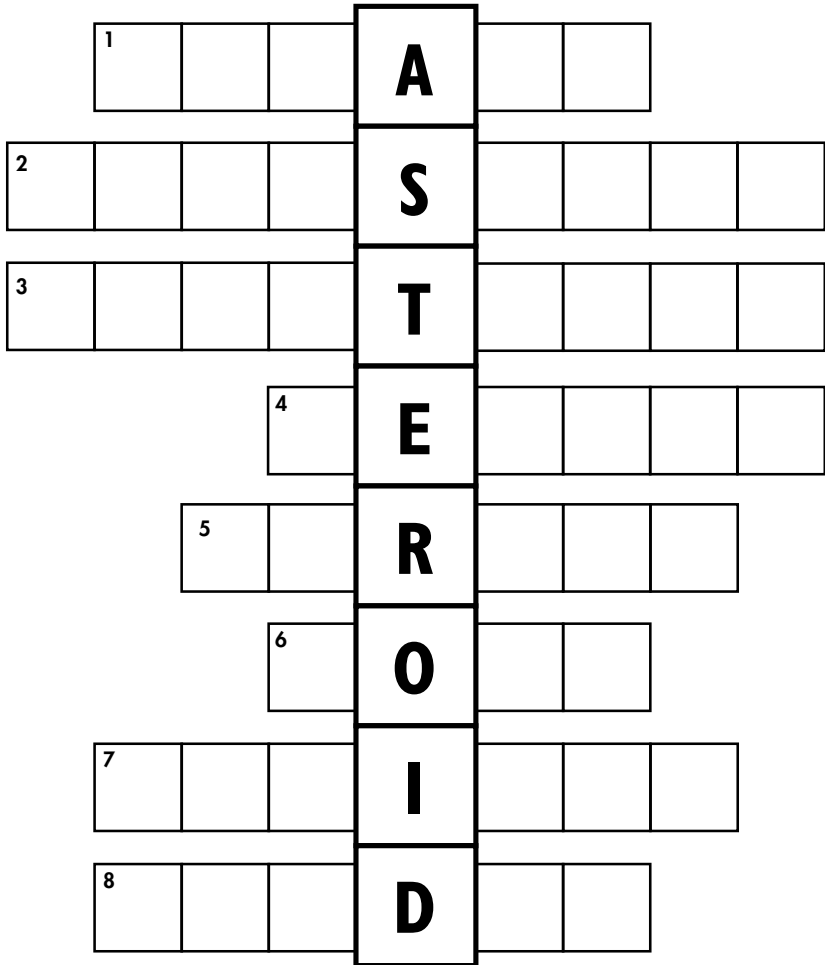

CLUES:

1. The Milky Way is one _____
2. Hubble Space _____
3. Atoms are made of protons, neutrons, and _____
4. Clouds of gas and dust _____
5. _____ Borealis, the Northern Lights
6. This orbits the Earth _____
7. The largest planet, fifth from the Sun _____
8. Type of spacecraft which comes to rest on the surface of a planet or moon _____

SERVICING MISSION

STS-109 Patch



Hubble Space Telescope Servicing Mission

The STS-109 crew successfully completed the servicing of the Hubble Space Telescope. The upgrades left Hubble with a new power unit, a new camera and new solar arrays. This was the fourth shuttle mission dedicated to servicing Hubble.

COUNT DOWN

How many can you count?

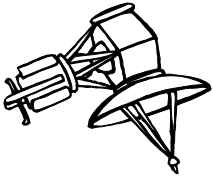

How many craters? _____

How many stars? _____

How many planets? _____

How many satellites? _____

How many flags? _____

How many lunar landers? _____

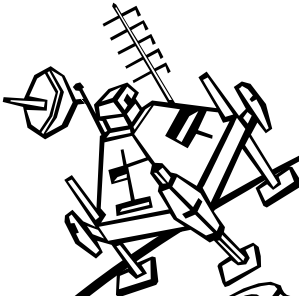
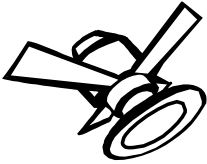

NASA SATELLITES

Helping to forecast weather

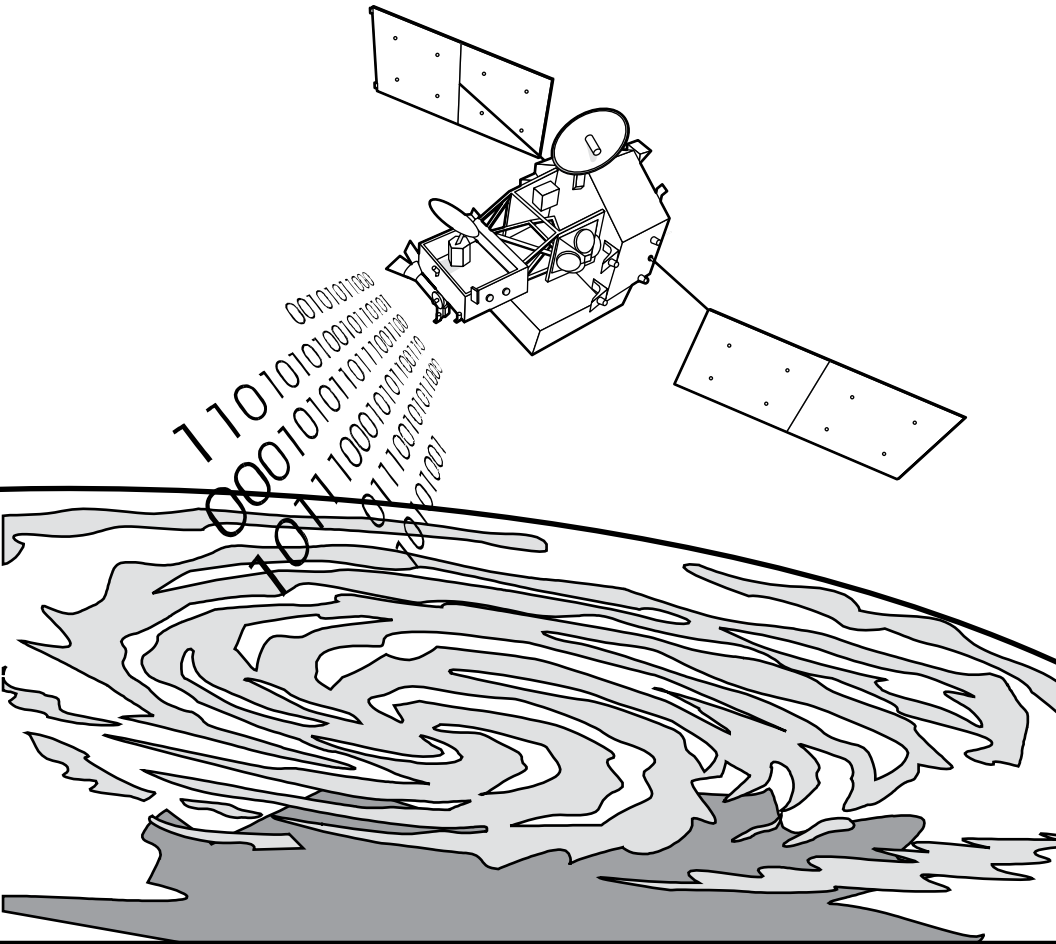

Did you know that improved hurricane forecasts, made possible by NASA satellites such as the Tropical Rainfall Measuring Mission (TRMM), can save lives and help early warning evacuation efforts?

FILL IN THE NUMBERS

Write in the missing digits

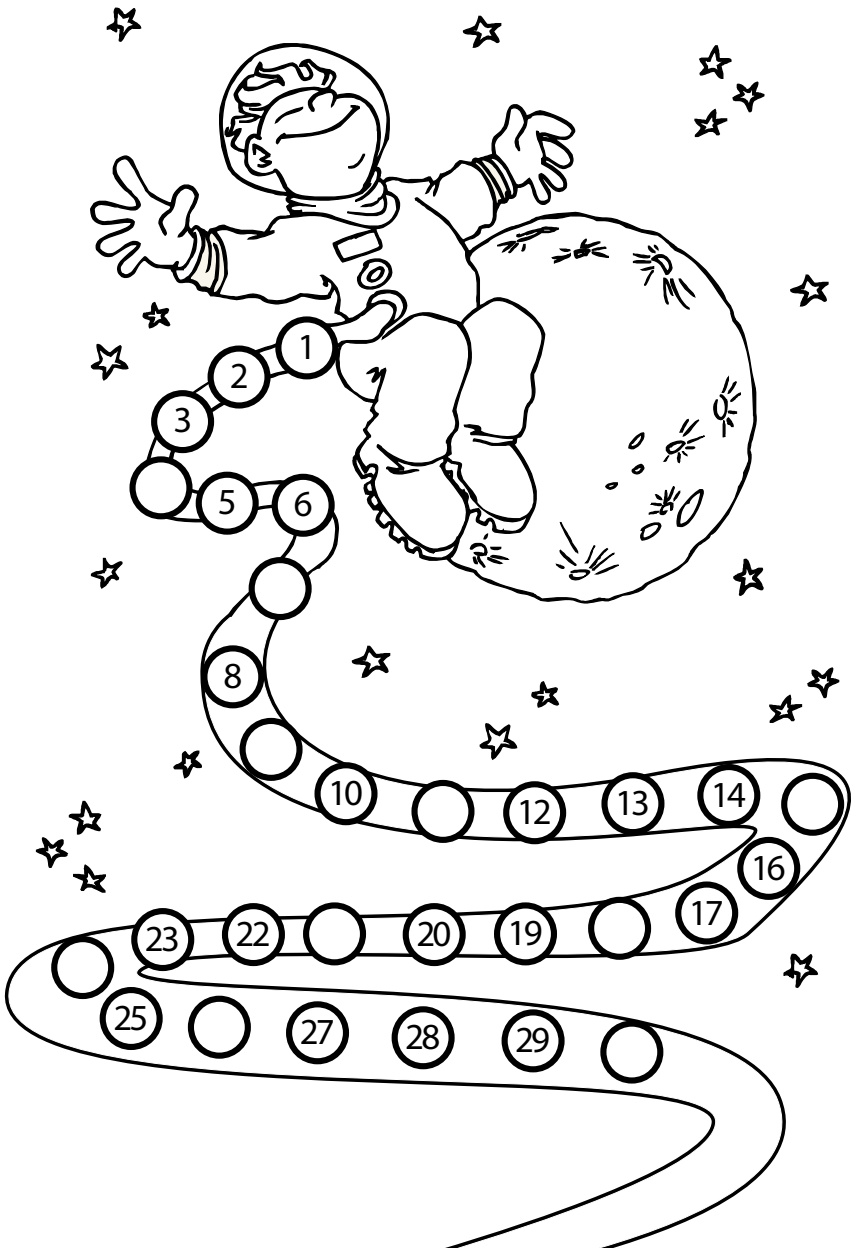

WORDS WITHIN WORDS

How many words can you spell using the letters in PLANET EARTH?

1. _____

6. _____

2. _____

7. _____

3. _____

8. _____

4. _____

9. _____

5. _____

10. _____



RHyme TIME

What other words rhyme with *EXPLORE*?

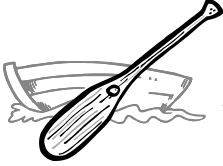



4



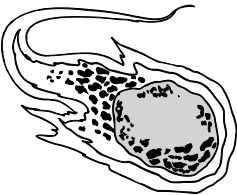

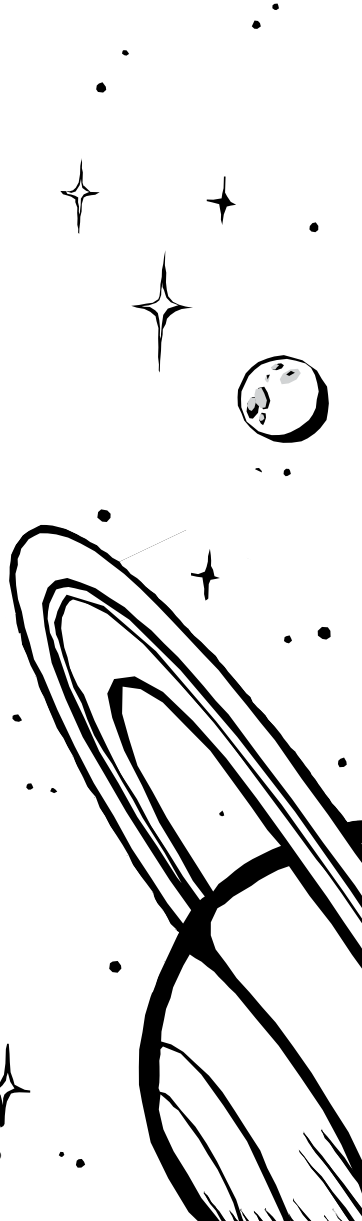

WHAT IS THE DIFFERENCE?

Find 8 things that are not the same

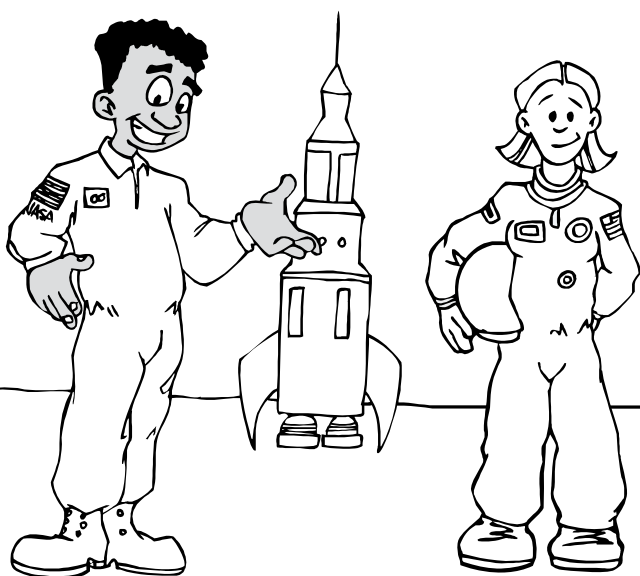
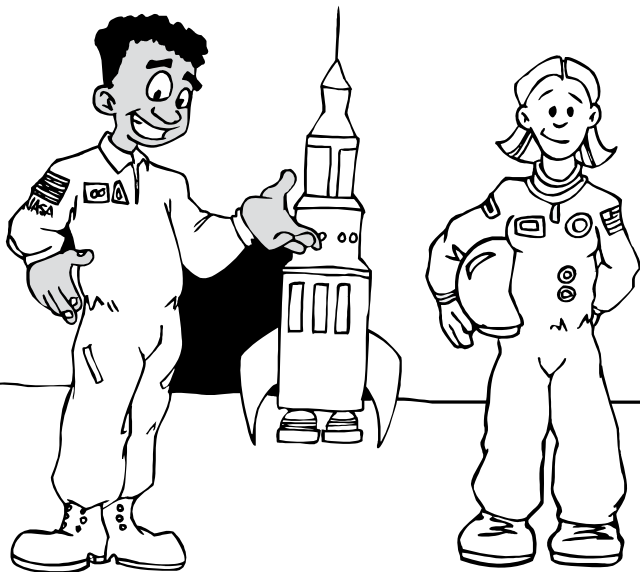

FUTURE SPACE TELESCOPE

James Webb Space Telescope (JWST)

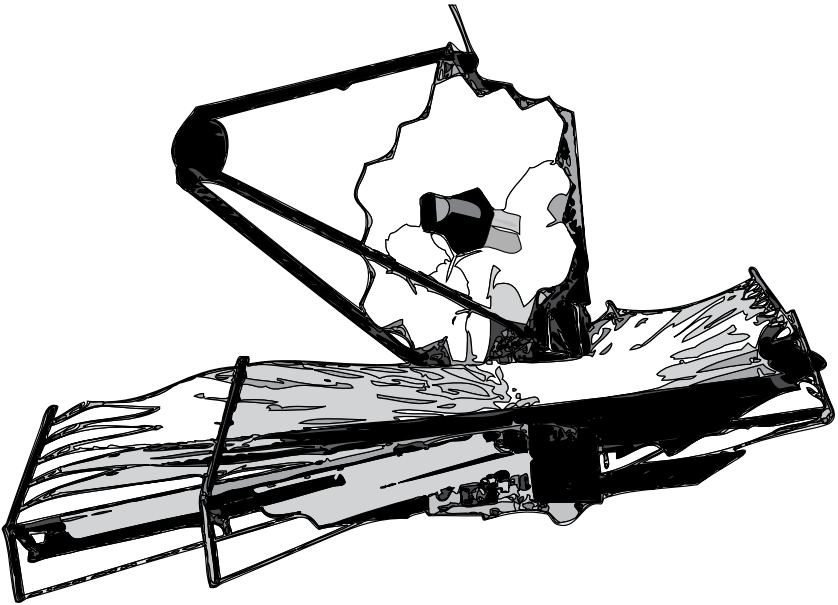

The James Webb Space Telescope (JWST) will take the place of the very popular Hubble Space Telescope. JWST is scheduled to launch in the year 2011. A million miles from Earth, the telescope will drift through space, peering back to the time when new stars and developing galaxies first began to illuminate the Universe.

ROCKET MAN

Draw lines to connect the dots

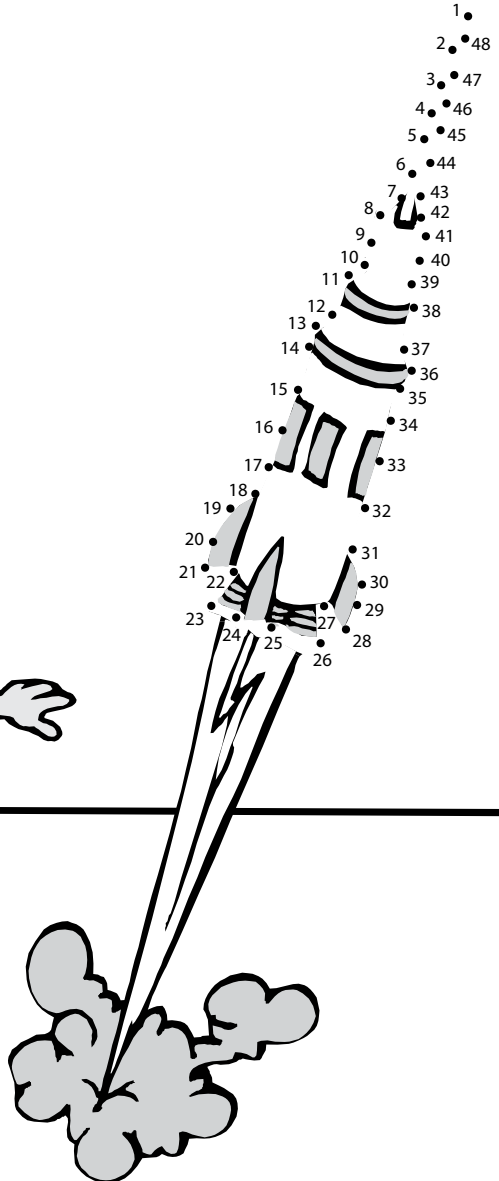
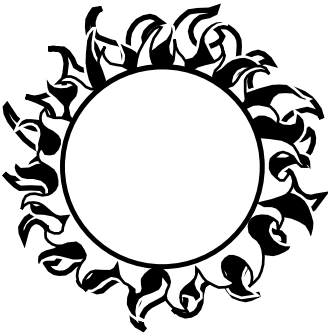

FIND THE SCIENCE

How many can you find?

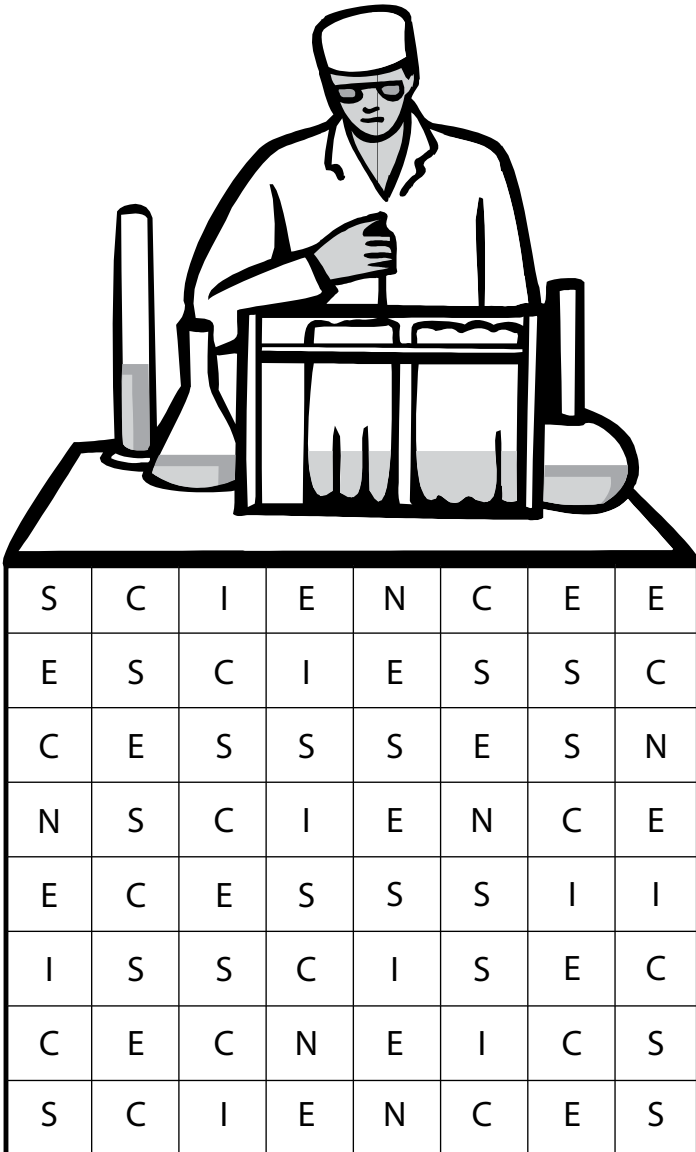

ROBOTICS

*Draw in the lines to finish
building this robot*

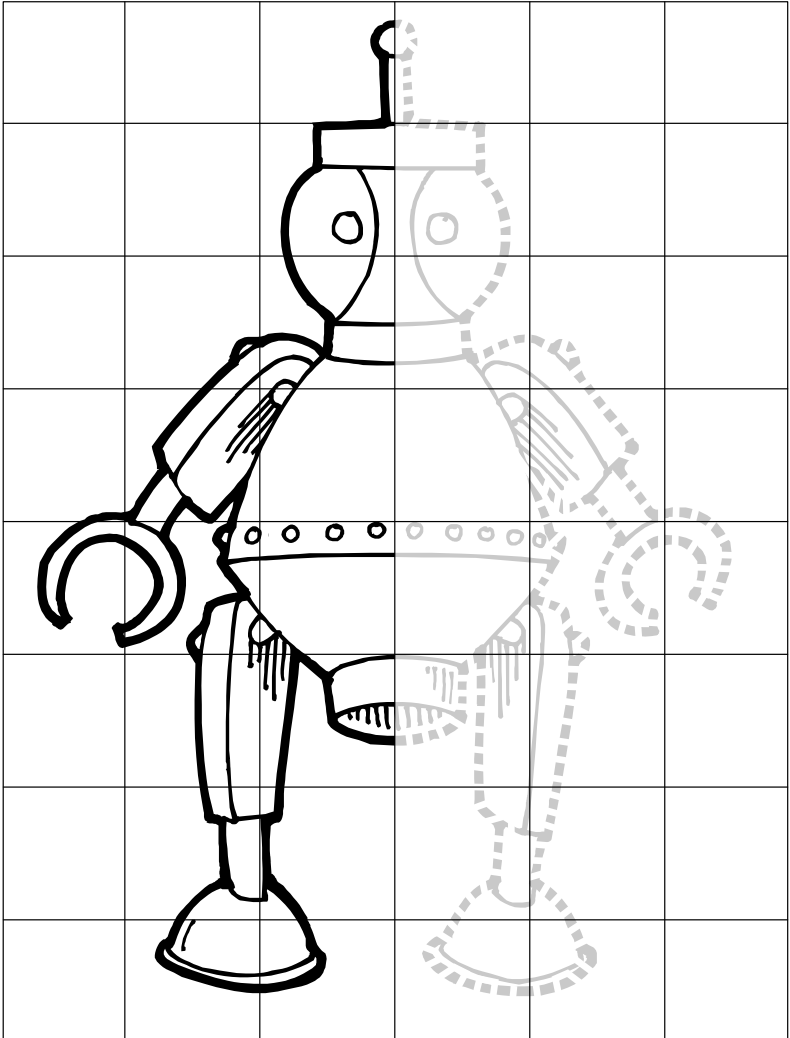

BACK TO EARTH

Bring our astronaut home

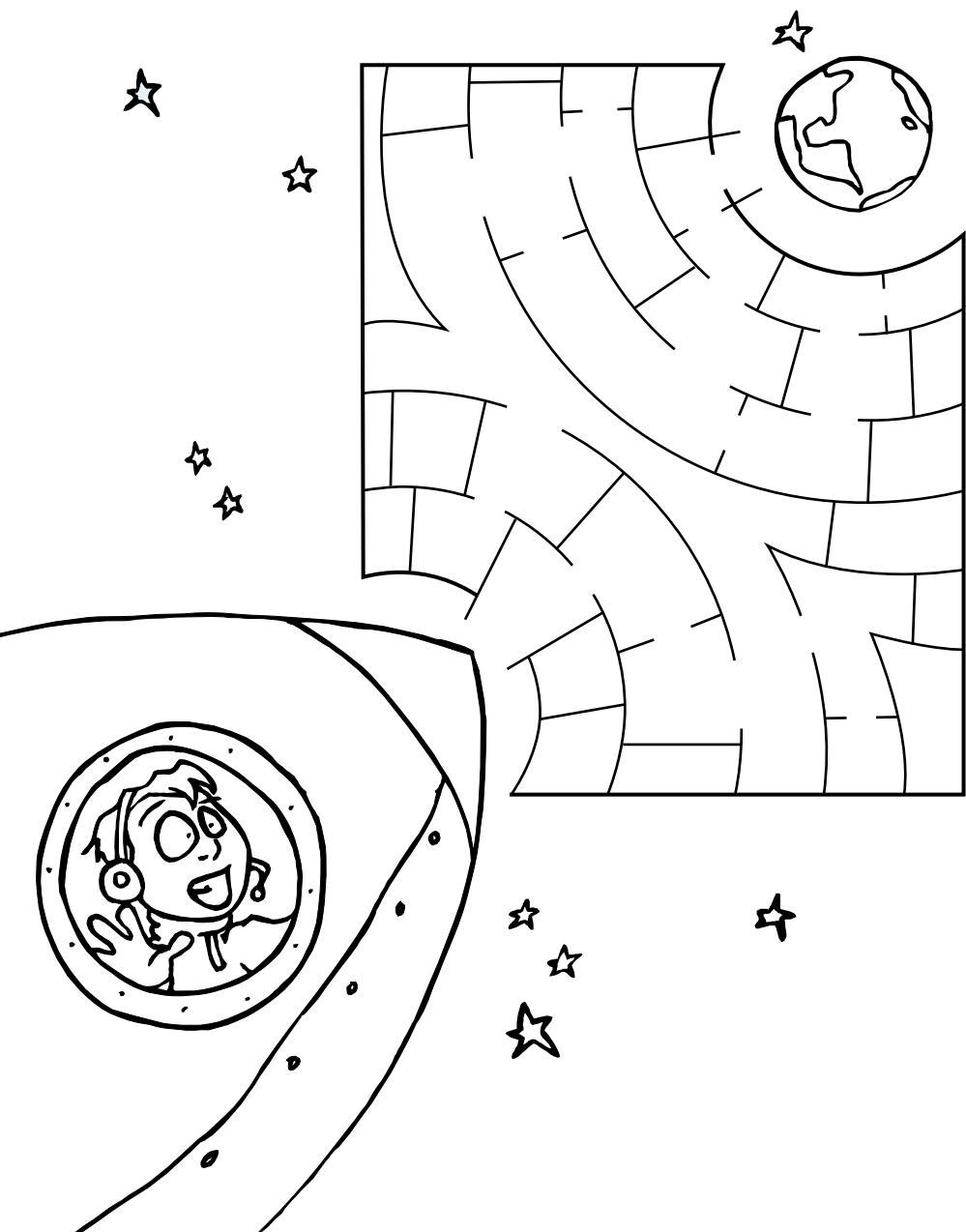

FUTURE EXPLORATION

New Discoveries

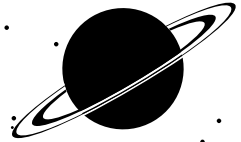
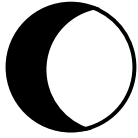

Future space tools will bring us amazing discoveries about the Universe and our own Solar System. Are there planets like Earth around other stars? Is there life on other planets and moons? What lies at the edge of the Universe? By using our creativity and imagination, we can build tools that may one day help solve these mysteries and many more!



**EXPLORE
MORE**

For more information on NASA
and its outreach programs, visit
these web sites:

<http://education.nasa.gov>

http://www.nasa.gov/audience/for_kids

<http://stargazers.gsfc.nasa.gov>

<http://ksnn.larc.nasa.gov>

<http://kids.msfc.nasa.gov/>



PACKED WITH THINGS TO DO!

