

MOSAIC

MARS ORBITERS FOR
SURFACE-ATMOSPHERE-IONOSPHERE
CONNECTIONS

AUGUST 2020
Mission Concept Study
Planetary Science Decadal Survey



National Aeronautics and Space Administration
www.nasa.gov

PRINCIPAL INVESTIGATOR
Robert Lillis
rlillis@berkeley.edu
University of California, Berkeley

CO PRINCIPAL INVESTIGATOR
David Mitchell
davem@berkeley.edu
University of California, Berkeley

JPL POINT OF CONTACT
Steve Matousek
steven.e.matousek@jpl.nasa.gov
Jet Propulsion Laboratory,
California Institute of Technology

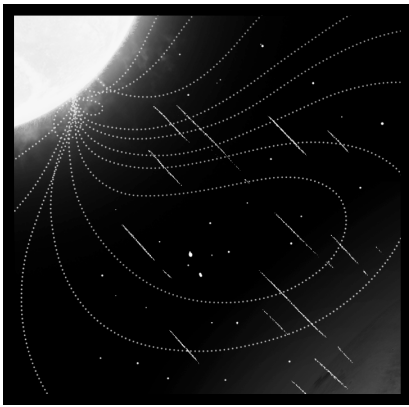

8 Space Weather

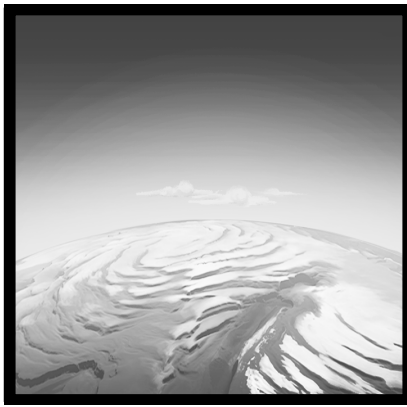

1 Ice



2 Winds

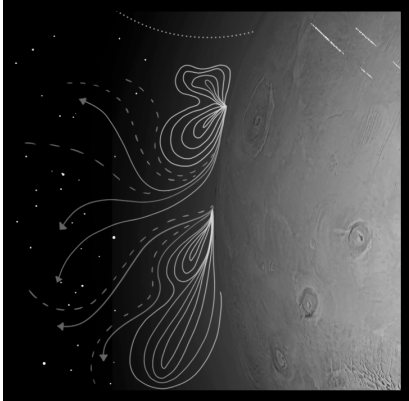

7 Magnetosphere



9 Human Exploration



3 Dust

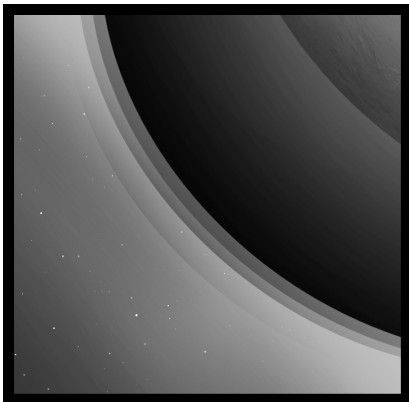

6 Exosphere

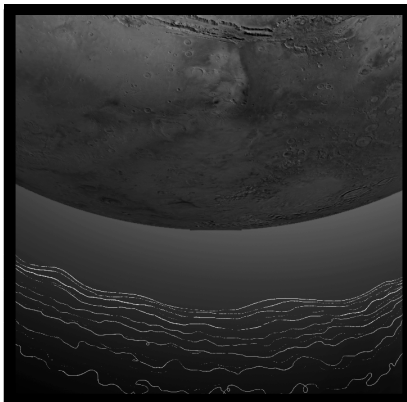

5 Ionosphere

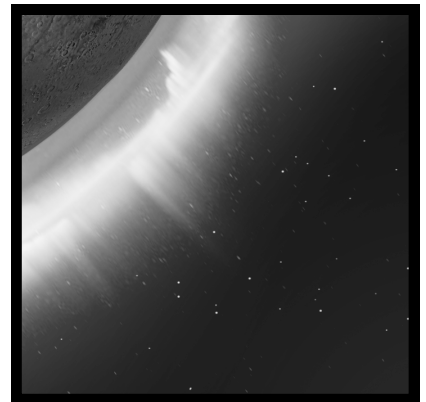

4 Thermosphere

Cover art shows 9 'mosaic' tiles. Each of the outer tiles represents an aspect of Mars' dynamic, interconnected climate system which MOSAIC will comprehensively investigate. Clockwise from top:

- 1) Surface and subsurface ice distribution, a resource for human explorers.
- 2) Atmospheric structure including wind.
- 3) Diurnal variability of the lower-middle atmosphere including the evolution of hazardous dust storms.
- 4) The thermosphere, revealed to us by airglow.
- 5) The ionosphere, whose variability impacts communication and navigation.
- 6) The exosphere, from which neutral H and O escape have driven climate evolution.
- 7) Mars' unique hybrid magnetosphere, which drives ion and sputtering escape.
- 8) Mars' space weather and radiation environment, modulated by the solar cycle and Mars' orbit.
- 9) The central tile (Human Exploration) represents the fact that most of these regions of the climate system need to be understood significantly better to allow safe human habitation and exploration on Mars.

Disclaimers/Acknowledgements

JPL URS clearance number: CL#20- 3534

Pre-Decisional Information – For Planning and Discussion Purposes Only

The research was carried out at the Jet Propulsion Laboratory, California Institute of Technology, under a contract with the National Aeronautics and Space Administration (80NM0018D0004).

The cost information contained in this document is of a budgetary and planning nature and is intended for informational purposes only. It does not constitute a commitment on the part of JPL and/or Caltech.

© 2020. All rights reserved.

Study Participants

MOSAIC PMCS Science Team*		
Participant	Contribution	Institution
Robert Lillis	Principal Investigator	SSL, UC Berkeley
David Mitchell	Deputy Principal Investigator	SSL, UC Berkeley
Bruce Jakosky	Science Team	LASP, University of Colorado
Amanda Brecht	Science Team	NASA Ames
Armin Kleinbohl	Science Team	NASA Jet Propulsion Laboratory, California Institute of Technology
Aymeric Spiga	Science Team	LMD, Paris
Beatriz Sánchez-Cano	Science Team	University of Leicester
Bruce Cantor	Science Team	Malin Space Science Systems
Cassie Stuurman	Science Team	NASA Jet Propulsion Laboratory, California Institute of Technology
Chi Ao	Science Team	NASA Jet Propulsion Laboratory, California Institute of Technology
Christopher Fowler	Science Team	SSL, UC Berkeley
David Andrews	Science Team	IRF Uppsala, Sweden
David Brain	Science Team	LASP, University of Colorado
David Hinson	Science Team	SETI Institute
François Forget	Science Team	LMD, Paris
François Leblanc	Science Team	LATMOS, Paris, France
Gordon Osinski	Science Team	U. Western Ontario
Hermann Opgenoorth	Science Team	University of Umea, Sweden
Isaac Smith	Science Team	PSI/University of York
Janet Luhmann	Science Team	SSL, UC Berkeley
Jared Espley	Science Team	NASA Goddard
Jasper Halekas	Science Team	University of Iowa
Josh Vander Hook	Science Team	NASA Jet Propulsion Laboratory, California Institute of Technology
Justin Deighan	Science Team	LASP, University of Colorado
Kerstin Peter	Science Team	University of Koln
Leslie Tamppari	Science Team	NASA Jet Propulsion Laboratory, California Institute of Technology
Luca Montabone	Science Team	Space Science Institute
Mark Lester	Science Team	University of Leicester
Martin Patzold	Science Team	University of Koln
Melinda Kahre	Science Team	NASA Ames
Michael Chaffin	Science Team	LASP, University of Colorado
Michael Mischna	Science Team	NASA Jet Propulsion Laboratory, California Institute of Technology
Michael Smith	Science Team	NASA Goddard
Michael Wolff	Science Team	Space Science Institute
Nick Heavens	Science Team	Space Science Institute
Oleg Vaisberg	Science Team	IKI Moscow, Russia
Ozgur Karatekin	Science Team	Royal Observatory of Belgium
Paul Withers	Science Team	Boston University
Sami Asmar	Science Team	NASA Jet Propulsion Laboratory, California Institute of Technology
Scott England	Science Team	Virginia Tech
Scott Guzewich	Science Team	NASA Goddard
Shannon Curry	Science Team	SSL, UC Berkeley
Silvia Tellman	Science Team	University of Koln
Steve Bougher	Science Team	University of Michigan
Tanya Harrison	Science Team	Planet Federal Inc.
Xiaohua Fang	Science Team	LASP, University of Colorado
David Kass	Science Team	NASA Jet Propulsion Laboratory, California Institute of Technology
Catherine Neish	Science Team	University of Western Ontario (U. Western Ontario)

*For a full list of Science Team members and roles see Appendix B.

MOSAIC PMCS JPL Study Team	
Steve Matousek, Study Lead	Nathan Barba, Lead System Engineer
Ryan Woolley, Mission Design	Ivair Gontijo, Payload System Engineer
Carlos Brinocoli, Cost	Katherine Park, Visual Strategy and Design
Valerie Scott, Payload	Mariko Burgin, Payload
Cassie Stuurman, Radar	Scott Hensley, Radar
Kevin Wheeler, Radar	Jan Martin, Radar
Brian Sutin, Payload	Jean Biancocone, Editor
Marc Lane, Configuration	David Hinkle, Graphics
Chester Everline, Constellation Probability of Success Analysis	Barbara Insua, Graphics
A Team, December 17, 2019	
Justin Boland, Facilitator	Damon Landau, Mission Design
Paul Johnson, Asst Study Lead	Jonathan Murphy, Project Systems Engineering & Formulation
Kamal Oudhiri, Communications Architectures & Research	Valerie Scott, Study Lead
Antranik Kolanjian, Cost	Mark Chodas, Assistant Study Lead
Claire Marie-Peterson, Documentation	Katherine Park, Visual Strategy
A Team Trade Space, February 5–6, 2020	
Justin Boland, Facilitator	Steven Zusack, Project Systems Engineering & Formulation
Randii Wessen, Architect	Mariko Burgin, Radar Science and Engineering
Paul Johnson, Asst Study Lead	Valerie Scott, Study Lead
Antranik Kolanjian, Cost	Alexander Austin, Systems Engineering
Claire Marie-Peterson, Documentation	Karla Hawkinson, Logistics
Damon Landau, Mission Design	
Team Xc, February 2020	
Alfred Nash, Facilitator	Shelly Sposato, cPower
Aron Wolf, cACS	Matthew Devost, cPropulsion
Davide Sternberg, cACS	Matthew Kowalkowski, cPropulsion
William Jones-Wilson, cACS	Jonathan Murphy, cSystems
Roger Klemm, cCDS	Alexander Austin, cSystems
Karen Lee, cCDS	Alessandra Babuscia, cTelecom Systems
Marc Lane, cConfiguration	Nick Emis, cThermal
Antranik Kolanjian, cCost	Eric Sunada, cThermal
Jonathan Murphy, cDeputy Systems Engineer	Daniel Forgette, cThermal
Robert Miller, cDeputy Systems Engineer	Hared Ochoa, cThermal
Gregory Welz, cGround Systems	Karla Hawkinson, Logistics
Jeffrey Stuart, cMission Design	Laura Newlin, Planetary Protection
Ronald Hall, cPower	Zachary Dean, Planetary Protection
Dhack Muthulingam, cPower	Jonathan Murphy, Systems Engineer
Team X, March 2020	
Alfred Nash, Facilitator	Matthew Spaulding, Mechanical
Aron Wolf, ACS	Jeffrey Stuart, Mission Design
Roger Klemm, CDS	Laura Newlin, Planetary Protection
Karen Lee, CDS	Ronald Hall, Power
Daniel Kolenz, Configuration	Paul Woodmansee, Propulsion
Antranik Kolanjian, Cost	William Smythe, Science
Benjamin Donitz, Deputy Systems Engineer	Edward Benowitz, Software
Gregory Welz, Ground Systems	Kareen Badaruddin, SVIT
Melora Larson, Instruments	Jonathan Murphy, Systems Engineer
Karla Hawkinson, Logistics	Thaddaeus Voss, Telecom Systems
Christopher Landry, Mechanical	Eric Sunada, Thermal

Table of Contents

For reader convenience, links for this study are provided for navigation purposes. After following a link, you can return to the previous page by pressing Command + Left Arrow (Mac) or Alt + Left Arrow (PC), or by using the Acrobat Page Navigation toolbar.

Cover Legend	
Disclaimers/Acknowledgements.....	i
Study Participants.....	ii
Table of Contents	iv
Fact Sheet.....	vii
Executive Summary.....	ix
1 Scientific Background and Objectives	1-1
1.1 Motivating Questions	1-1
1.2 Preparation for Human Exploration of Mars.....	1-8
1.3 MOSAIC Goals, Objectives, and Relevance.....	1-8
1.4 Science Traceability (FO 1-1)	1-10
2 High-Level Mission Concept	2-1
2.1 Overview	2-1
2.2 Concept Maturity Level (CML).....	2-3
2.3 Technology Maturity.....	2-3
2.4 Key Trades	2-4
3 Technical Overview.....	3-1
3.1 Instrument Payload Description.....	3-1
3.2 Flight System.....	3-9
3.3 Concept of Operations and Mission Design.....	3-16
3.4 Constellation Risk List.....	3-20
4 Development Schedule and Schedule Constraints	4-1
4.1 High-Level Mission Schedule.....	4-1
4.2 Technology Development Plan.....	4-2
4.3 Development Schedule and Constraints.....	4-2
5 Mission Life-Cycle Cost.....	5-1
5.1 Costing Methodology and Basis of Estimate.....	5-1
5.2 Cost Estimate(s)	5-1
5.3 Potential Cost-Saving Options.....	5-5
Appendix A Acronyms.....	A-1
Appendix B Design Team Study Report.....	B-1
Appendix C Special Technical Analyses	C-1
Appendix D Additional Information on Technologies and Techniques	D-1
Appendix E References.....	E-1

Figures

Figure 1-1. Schematic of some expected connections between the various Martian climate domains, which MOSAIC will systematically explore.	1-1
Figure 1-2. Examples of present-day water ice on Mars.	1-2
Figure 1-3. The left panel shows a regional dust storm as seen by a single Sun-synchronous polar orbiter, while the right panel represents a synthetic view of the same storm from areostationary orbit.	1-4
Figure 1-4. Dynamics in Mars' thermosphere are poorly understood. Very sparse in situ MAVEN wind data is highly variable, often disagreeing completely with leading models	1-6
Figure 1-5. Mars' upper atmosphere responds strongly to lower atmospheric dust forcing.	1-6
Figure 1-6. Mars' ionosphere is embedded mostly within the upper atmosphere and is influenced by a number of planetary and space weather factors.	1-7
Figure 1-7. Multi-point plasma measurements are needed to understand mass and energy flows throughout Mars' uniquely rich and interconnected hybrid magnetosphere.	1-7
Figure 2-1. Baseline MOSAIC constellation delivery concept.	2-2
Figure 2-2. MOSAIC constellation launch configuration.	2-2
FO 2-1. Shows the baseline MOSAIC overview of the investigations, platforms that host the investigations, launch and cruise to Mars configurations, and the Mars orbits with numbers of platforms in each orbit.	2-5
FO 3-1. Spacecraft platforms.	3-4
Figure 3-1. Mothership Flight System Configuration.	3-12
Figure 3-2. Shows Aero Smallsat A or B on the ESPA ring port with some of the flight system subsystems shown.	3-15
Figure 3-3. Polar platform node precession after orbit phasing.	3-17
Figure 3-4. Baseline Constellation Telecommunications Concept of Operations.	3-17
Figure 3-5. Mothership platform modes and durations.	3-19
Figure 3-6. Polar platform power modes.	3-19
Figure 3-7. Elliptical combined maneuver.	3-19
Figure 3-8. Elliptical combined maneuver.	3-20
Figure 3-9. Areo Carrier science modes of operation.	3-20
Figure 3-10. Areo carrier instrument pointing constraints.	3-20
Figure 4-1. Example timeline for the MOSAIC constellation.	4-1

Tables

Table 1-1. Traces goals to investigations (FO 1-1).	1-10
Table 1-2. Traces investigations to specific measurement requirements (FO 1-1).	1-10
Table 2-1. CML helps to describe the maturity of a concept.	2-3
Table 2-2. Key spacecraft technologies are ready or soon will be.	2-3
Table 2-3. Key payload technologies are ready, soon will be, or can be with small focused investment.	2-3
Table 3-0. Sections of MOSAIC constellation study report where baseline mission and descope 1 mission information is located.	3-1
Table 3-1. Instrument list. Also referred to as FO 3-2.	3-6
Table 3-2. Payload Mass and Power.	3-9

Table 3-3. Mothership Flight System Element Mass and Power.....	3-10
Table 3-4. MOSAIC Mothership Platform Flight System Element Characteristics.	3-11
Table 3-5. Mini-Mothership Flight System Element Mass and Power.	3-12
Table 3-6. Polar Platform Flight System Element Mass and Power.	3-12
Table 3-7. MOSAIC Polar Platform Flight System Element Characteristics.	3-13
Table 3-8. Elliptical Platform Flight System Element Mass and Power.	3-13
Table 3-9. MOSAIC Elliptical Platform Flight System Element Characteristics.	3-14
Table 3-10. Areo Carrier Platform Flight System Element Mass and Power.	3-14
Table 3-11. MOSAIC Areo Carrier Platform Flight System Element Characteristics.	3-14
Table 3-12. Areo A/B Platform Flight System Element Mass and Power.	3-15
Table 3-13. MOSAIC Areo A/B Platform Flight System Element Characteristics.	3-16
Table 3-14. Baseline Constellation Mission Design.....	3-16
Table 3-15. Platform Data Volume per Sol.	3-17
Table 3-16. Baseline Constellation Mission Design.....	3-18
Table 3-17. Mothership Mission Operations and Ground Data Systems.	3-18
Table 3-18. Mothership operational modes.	3-19
Table 3-19. Areo Carrier and Areo A/B Instrument Concept of Operations.....	3-20
Table 3-20. Areo Carrier Mission Operations and Ground Data Systems.	3-21
Table 3-21. Risk table elaborates constellation risks. Note that further detail on probability of success high-level analysis is in Appendix C.	3-22
Table 3-22. Likelihood of Occurrence.....	3-22
Table 3-23. Mission Risk Consequence of Occurrence.....	3-22
Table 4-1. MOSAIC development timeline..	4-1
Table 4-2. Spacecraft technologies requiring further development (TRL 5 or less).....	4-2
Table 4-3. Instrument technologies at TRL 4 or TRL 5 requiring further development as of July 2020. Time to TRL6 is from funded start.	4-2
Table 4-4. MOSAIC Class D spacecraft development timeline starts later and ends at the same time as Table 4 1.....	4-2
Table 5-1. Baseline Constellation and Descope 1 Constellation.	5-1
Table 5-2. Model Cost Assessment for MOSAIC Baseline Constellation (FY25 \$M).....	5-3
Table 5-3. New-Space Commercial Cost Method for MOSAIC Baseline Constellation (FY25 \$M).	5-3
Table 5-4. Model Cost Assessment for MOSAIC Descope 1 Constellation (FY25 \$M).	5-4
Table 5-5. New-Space Commercial Cost Method for MOSAIC Descope 1 Constellation (FY25 \$M).	5-4
Table 5-6. Polar, Elliptical, Areo Carrier, and Areo Smallsats A and B Cost Validation (FY25 \$M). MOSAIC smallsat platform costs validate well with SSCM model estimates.....	5-5
Table 5-7. Total Mission Cost Funding Profile (\$M) for the MOSAIC Baseline Constellation (FY cost in Real Year Dollars. Total in Real Year and FY25 Dollars).....	5-6
Table 5-8. Total Mission Cost Funding Profile (\$M) for the MOSAIC Descope 1 Constellation (FY cost in Real Year Dollars. Total in Real Year and FY25 Dollars).....	5-7

MOSAIC: MARS ORBITERS FOR SURFACE ATMOSPHERE-IONOSPHERE CONNECTIONS

The interconnections between the surface, lower and upper atmospheres, and ionized space environment of Mars are stronger than previously thought, but poorly understood. Systemic and simultaneous observations are necessary for a full understanding of these physical processes to a level that enables safe human exploration of Mars.

MOSAIC AIMS TO:

I. Understand Mars' present day climate processes and their inter-connections, from the sub-surface to the solar wind.

IN ORDER TO:

II. Identify hazards, characterize resources, and demonstrate technologies to enable the human exploration of Mars.

I. SCIENCE QUESTIONS

1
2
3 How do volatiles move between the subsurface, surface, and atmosphere?

2
3 How does the Martian lower-middle atmosphere respond diurnally, on meso- and global scales, to the seasonal cycle of insolation?

2
3
4
5
6
7
8 How does coupling from the lower atmosphere combine with the influence of space weather (solar wind, SEPs, and solar EUV) to control the upper atmospheric system and drive atmospheric escape?

II. EXPLORATION QUESTIONS

1 How, where, and when can future astronauts access extractable water ice resources?

2
3 With what degree of accuracy can Martian weather be forecast, for operational purposes?

4 How will mesospheric and thermospheric winds affect aerobraking spacecraft?

5
7
8 How will space weather effects on the Mars ionosphere affect surface-surface and surface-orbit communications?

8 How will energetic particle radiation affect astronauts in Mars orbit?

TECH DEMO
Can reliable high-bandwidth Earth-Mars communication be maintained?

INVESTIGATIONS

Investigation 1 Ice Distribution

Measure the 3-D distribution of ice from the surface to 10m below.



Investigation 2 Atmosphere Structure

Measure the geographic and altitude distribution of pressure, winds, aerosol concentrations, water vapor, ozone, and temperatures in the Mars lower and middle atmosphere.



Investigation 3 Atmosphere Diurnal Behavior

Measure the complete diurnal and geographic behavior of the atmosphere and evolution of Martian dust and ice clouds.

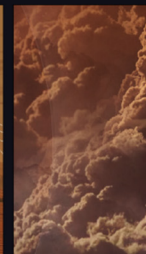

Investigation 4 Thermosphere

Measure the global 3-D composition, structure, and winds in Mars' thermosphere.

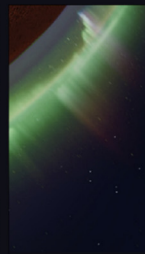

Investigation 5 Ionosphere

Measure the global 3-D structure of Mars' ionosphere.

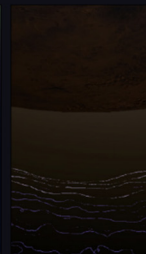

Investigation 6 Exosphere/Neutral Escape

Measure the 3-D density and temperature structure of Mars hydrogen and oxygen exospheres.



Investigation 7 Plasma/Ion Escape

Measure (from multiple viewpoints) fluxes of light and heavy ions, magnetic field and topology, plasma waves, and electric fields w/in and between all regions of Mars' hybrid atmosphere.



Investigation 8 Space Weather

Measure the magnetic field and plasma conditions in the upstream solar wind, and solar extreme ultraviolet irradiance.

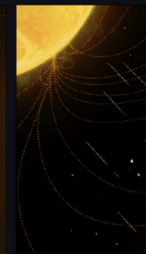

Pre-decisional Information—For Planning and Discussion Purposes Only.

MOSAIC: MARS ORBITERS FOR SURFACE ATMOSPHERE-IONOSPHERE CONNECTIONS

Ten coordinated satellites making simultaneous measurements of Mars' climate system, many for the first time.

3 ORBIT TYPES

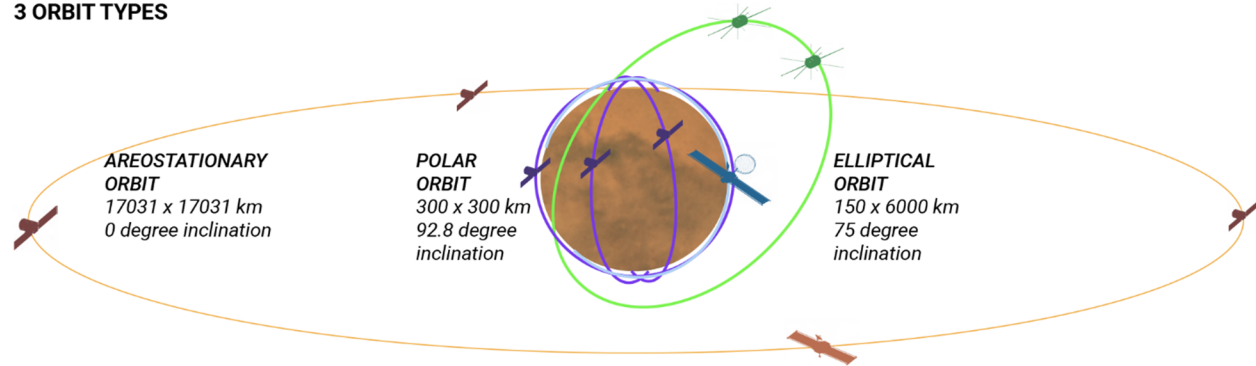

5 PLATFORMS

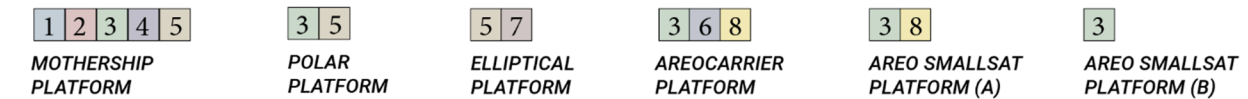

10 SPACECRAFT

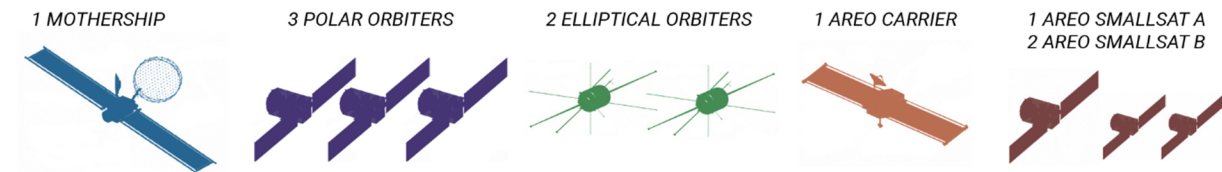

LAUNCH VEHICLE CONFIGURATION

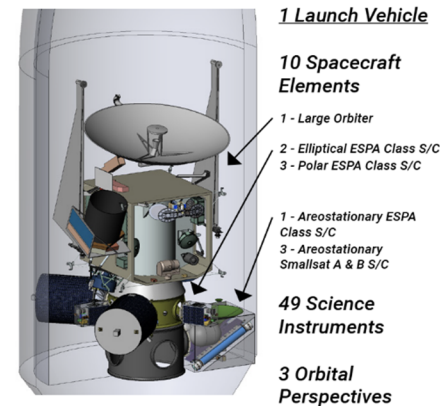

CONSTELLATION DELIVERY

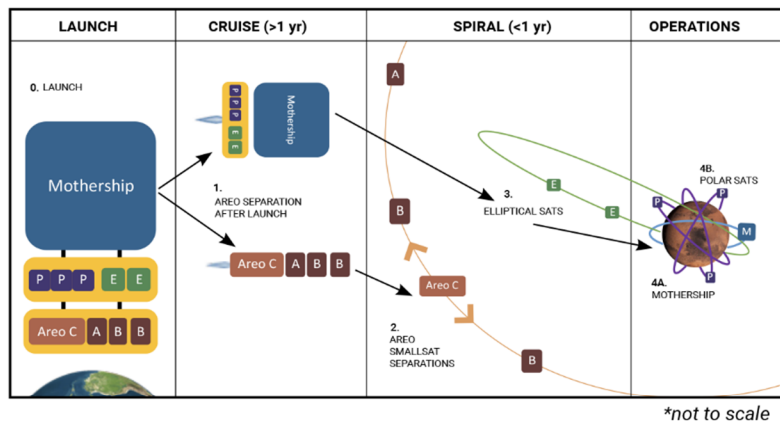

BASELINE CONSTELLATION (FY25\$M)

	Estimate	Reserves	Total	Reserves	Total		
Development (A-D)	2,315.5	30%	694.65	3,010.2	50%	1,157.8	3,473.3
Mothership (1)	586.8	30%	176.0	762.8	50%	293.4	880.2
Polar Platform (3)	57.9	30%	17.4	75.3	50%	29.0	86.9
Elliptical Platform (2)	53.0	30%	15.9	68.9	50%	26.5	79.5
Areostationary Platform (4)	172.7	30%	51.8	224.5	50%	86.4	259.1
Others Develop. Costs	1,445.1	30%	433.5	1,878.6	50%	722.6	2,167.7
Launch Vehicle	274.6	-	-	274.6	-	-	274.6
Operations (E/F)	377.5	15%	56.6	434.1	25%	94.4	471.9
Full Lifecycle Cost	2,967.6	28%	751.3	3,718.8	46%	1,252.1	4,219.7

DESCOPE 1 CONSTELLATION (FY25\$M)

	Estimate	Reserves	Total	Reserves	Total		
Development (A-D)	1,592.3	30%	477.7	2,070.0	50%	796.1	2,388.4
Mothership (1)	419.6	30%	125.9	545.5	50%	209.8	629.4
Polar Platform (3)	57.9	30%	17.4	75.3	50%	29.0	86.9
Elliptical Platform (2)	53.0	30%	15.9	68.9	50%	26.5	79.5
Areostationary Platform (4)	172.7	30%	51.8	224.5	50%	86.4	259.1
Others Develop. Costs	889.1	30%	266.7	1,155.8	50%	444.5	1,333.6
Launch Vehicle	274.6	-	-	274.6	-	-	274.6
Operations (E/F)	328.0	15%	49.2	377.2	25%	82.0	410.1
Full Lifecycle Cost	2,194.9	27%	526.9	2,721.8	46%	878.1	3,073.0

Pre-decisional Information—For Planning and Discussion Purposes Only.

Executive Summary

The Martian climate system has been revealed to be at least as complex as that of Earth. Over the last 20 years with no dedicated climate missions, a fragmented and incomplete picture has emerged of its structure and variability. We remain largely ignorant of many of the physical processes that drive matter and energy flow between and within the various climate domains, from the shallow subsurface to the exosphere.

Only with high cadence, simultaneous, global observations of Mars' different climate domains over diurnal and seasonal cycles can we unravel the spatial and temporal connections governing the current Martian climate system.

Mars Orbiters for Surface-Atmosphere-Ionosphere Connections (MOSAIC) is a constellation of orbiting platforms, focused on understanding these connections through systematic observations of the Mars climate system. MOSAIC will characterize climate system variability diurnally and seasonally, on meso-, regional, and global scales, targeting the shallow subsurface all the way out to the solar wind, making many first-of-their-kind measurements. It is motivated by well-established Decadal Survey (2011) and MEPAG (2018) goals. MOSAIC's measurements and unique mission architecture will also enable human exploration of Mars by providing valuable water resource prospecting, hazard forecasting, and the demonstration of new communications technologies and strategies.

MOSAIC consists of six distinct types of platforms, with orbital parameters, instrument payloads, and operations uniquely tailored to observe the Mars climate system from three unique and complementary perspectives. First, low circular near-polar sun-synchronous orbits (a large mothership and three smallsats spaced in local time) enable vertical profiling of wind, aerosols, water and temperature, as well as mapping of surface and subsurface ice. Second, elliptical orbits sampling all of Mars' plasma regions enable multi-point in situ measurements necessary to understand mass/energy transport and ion-driven escape. Last, areostationary orbits enable a) synoptic views of the lower atmosphere necessary to understand dynamics on global and mesoscales, b) global views of the hydrogen and oxygen exospheres, and c) upstream

measurements of space weather conditions. Three of the six platform types require multiple spacecraft to ensure adequate spatial and temporal coverage of the climate system; thus MOSAIC is comprised of 10 spacecraft hosting 49 scientific instruments.

The MOSAIC mission can launch on a single Falcon Heavy reusable or comparable launch vehicle. The constellation would be delivered by using two solar electric propulsion (SEP) systems—one on the mothership going to low-Mars orbit, and one on the largest areostationary orbiter. The areostationary platforms thrust to their intended equatorial orbit, where they separate and drift to equidistantly spaced locations around the ring. The mothership carries the smaller elliptical and polar satellites to Mars where they separate to achieve their final orbits. The full cruise and transition would take 2–3 years for all elements to reach their final destination, but science measurements could begin earlier.

MOSAIC's architecture is inherently modular and cost effective, taking advantage of recent advances in off-the-shelf instruments and subsystems and is well-suited to contributions of instruments and/or platforms by international partners or private industry. This study examined both baseline and threshold science missions, as well as a significantly lower cost option that preserves global and diurnal coverage at the expense of measurements of ice or wind. The study utilized both traditional Jet Propulsion Laboratory (JPL) cost models based on past missions, in addition to much lower cost commercial off-the-shelf (COTS)-type approaches to small spacecraft development.

MOSAIC will revolutionize our understanding of the processes by which matter and energy move within and between the reservoirs of the Martian climate system to drive the current climate and how it affected past climate evolution. In doing so, MOSAIC will also harvest valuable information about the Martian environment and resource availability to ensure safe human exploration of Mars. MOSAIC will achieve this by making unprecedented measurements enabled by the deployment of the first constellation of satellites at another body in our Solar System.

1 Scientific Background and Objectives

Long-considered an inspiring or baleful presence in the Earth’s night sky, Mars’ geological record preserves something that mostly has been obliterated from Earth and Venus: the story of the first billion years on a rocky planet with an atmosphere. It is the story of transition from a molten ball to a solid surface, re-shaped by water and winds as much as lava. It is the story of a planet once warm and damp enough to support life on its surface. And it is a story we want to read in person. The 2018 NASA Strategic Plan (NASA 2018) calls out the Moon and Mars as the only specific destinations for deep space exploration with human beings.

Prior to sending humans, we need to do our due diligence to support in-person activities on Mars. The Strategic Plan also says that research and technology is necessary to “enable human missions to the surface of Mars”. Many strategic knowledge gaps have been identified that could endanger human missions to Mars (Beaty et al. 2012). Central among these are those related to the weather (particularly dust storms), the radiation environment, and the use of Mars water for human life support.

Our knowledge of present Martian climate is fragmented and incomplete. We lack the observations needed to understand the key interconnections linking its various regions, from the subsurface to the exosphere.

We have studied the Mars environment enough to know what we do not know, but not enough to understand its climate processes or keep astronauts safe in orbit or on its surface. The last two decades have seen a significant increase in the quantity and variety of observations characterizing the thermal structure and basic composition of the Mars atmosphere, from the surface to the exosphere. The incomplete picture that has emerged forms the basis for understanding the physical processes that control the current Martian climate, with information from the general circulation (Forget et al. 1999, Bougher et al. 2015), the role of clouds (Clancy et al. 2017, Colaprete et al. 2003, Madeleine et al. 2012) and photochemistry (Chaffin et al. 2017, Barabash et al. 2007, Gonzalez-Galindo et al.

2013), the development of dust storms both local (Rafkin 2009) and global (Elrod et al. 2019, Bottger et al. 2004, Clancy et al. 2010), as well as channels and rates of atmospheric escape (Brain et al. 2016, Chaffin et al. 2018, Clarke et al. 2014, Cravens et al. 2016, Curry et al. 2016, Dong et al. 2015, Dubinin et al. 2017, Edberg et al. 2010, Lillis et al. 2017).

A qualitative diagram is shown in Figure 1-1 of our current understanding of the key physical processes that drive matter and energy flow within and between the various climate reservoirs. However we are still largely ignorant of the relative size of, or feedbacks between, these processes. To successfully unravel Mars’ present day interacting climate processes and shed light on past processes, the following three questions must be addressed.

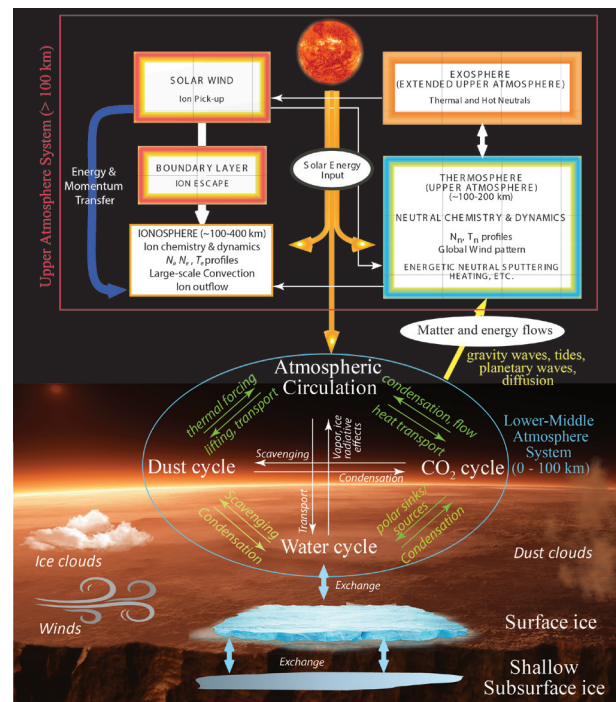

Figure 1-1. Schematic of some expected connections between the various Martian climate domains, which MOSAIC will systematically explore.

1.1 Motivating Questions

Question 1: How do volatiles move between the Martian subsurface, surface, and atmosphere?

Most water on Mars persists as surface and subsurface ice in the polar regions and mid-latitudes, concentrated at $\approx 35^\circ\text{N/S}$. The polar caps consist of a “residual” component made up

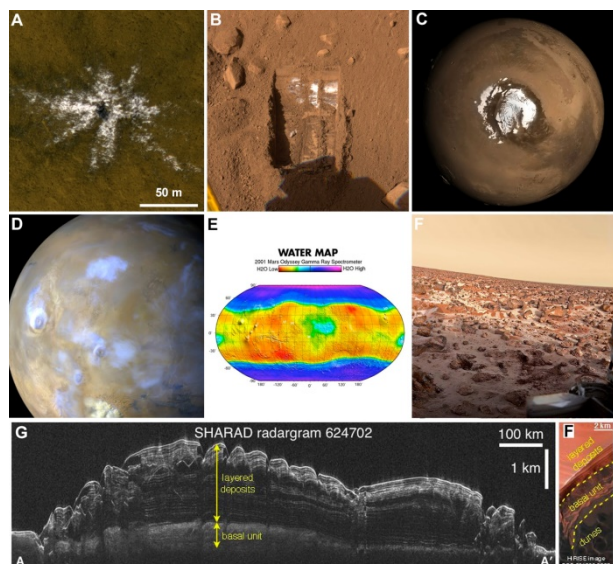

Figure 1-2. Examples of present-day water ice on Mars. **(A)** Ice-excavating impact crater imaged by HiRISE. Credit: NASA/JPL-Caltech/UA. **(B)** Ice exposed in a trench dug by the Phoenix lander. Credit: NASA/JPL-Caltech/UA/Texas A&M. **(C)** The north polar cap of Mars visualized in springtime. Credit: NASA/JPL-Caltech/MSSS/GSFC. **(D)** Water ice clouds (blue) imaged by MARCI. Credit: NASA/JPL-Caltech/MSSS. **(E)** Mars Odyssey GRS map of hydrogen abundance as a proxy for near-surface water ice content. Credit: (Boynton et al. 2002). **(F)** Early morning water ice frost on Mars imaged by the Viking 2 lander. Credit: NASA/JPL-Caltech/Ted Stryk. **(G)** SHARAD radargram of the northern polar layered deposits. Credit: NASA/JPL-Caltech/Uni. of Rome/SwRI. **(H)** HiRISE view of the layers within the northern cap for context. Credit: NASA/JPL-Caltech/UA.

of layered water ice (and in the southern residual cap, carbon dioxide ice) and dust that persists throughout the course of the Martian year, and a “seasonal” carbon dioxide and water ice frost component that freezes out of the atmosphere onto the surface in late fall and persists into spring (Benson and James 2005). The season-dependent temperature gradients between the ice-covered and ice-free ground along the cap edges result in significant weather activity, such as polar spiral storms and frontal storms (e.g. Malin et al. 2008, Wang and Fisher 2009). While the seasonal component of the northern polar cap is highly repeatable in its spatial distribution each year, reaching $\sim 50^\circ\text{N}$ at its maximum extent (e.g. Bass et al. 2000), the seasonal southern polar cap is much more variable (Jakosky and Haberle 1990). The residual component of the south polar cap is

also eroding at present—behavior not observed in the northern residual cap (Malin et al. 2001).

These changes have been meticulously tracked with the Mars Orbiter Camera aboard Mars Global Surveyor and the Mars Color Imager and Context Camera aboard Mars Reconnaissance Orbiter (Calvin et al. 2015), giving us over 10 Mars years of continuous records of the dynamism of the polar caps. However, the mechanisms driving the variability of the southern polar cap are poorly understood and our knowledge of the relationship between surface and subsurface ice distribution across the planet is limited based on the current available data.

Subsurface ice has been observed and/or inferred based on several independent lines of evidence, including neutron spectrometry (Boynton et al. 2002, Feldman et al. 2007), ground-penetrating radar (Stuurman et al. 2016, Bramson et al. 2015), in situ observation (Renno et al. 2009), and present-day excavation by impacts (Byrne et al. 2009, Dundas and Byrne 2010). Factors influencing the cryosphere depth include surface albedo, mean annual surface temperature, the thermal and diffusive properties of the crust as a function of depth, as well as Mars’ internal heat flow ($\sim 8\text{--}25\text{ mW/m}^2$) (Solomon and Head 1990, Plaut et al. 2007, Phillips et al. 2008). Local variations in these factors can result in differences in desiccation depths ranging from several meters to over a kilometer (e.g., Clifford 1993).

Heterogeneity in subsurface ice has been mapped at coarse resolution and deeper scales using past ground-penetrating radar instruments Mars Advanced Radar for Subsurface and Ionosphere Sounding (MARSIS) and SHallow RADar (SHARAD) (Stuurman et al. 2016, Petersen et al. 2018, Brothers et al. 2015, Bramson et al. 2015). These instruments, however, cannot map subsurface water ice heterogeneity shallower than 15 m or at horizontal resolutions finer than 10–15 km. As a result, we can observe areas that have bulk amounts of deep relic ice but not areas that are shallow enough to be affected by present-day exchange with the atmosphere. Additionally, while SHARAD has been highly effective at mapping the polar regions and detecting subsurface geologic interfaces below icy deposits in the mid-latitudes, it has performed less effectively at mapping older, rockier, higher-loss (i.e., more attenuating) geologic materials

(Stillman and Grimm 2011). Consequently, the picture we have of the Martian subsurface using our current suite of instruments is highly heterogeneous and incomplete—especially in the shallow subsurface.

In addition to mapping the distribution and quantity of subsurface water ice, the global average atmospheric water vapor is a key factor in determining the extent of stable ground ice on Mars. Modeling has found that diffusion from the atmosphere as the sole source of water can support a ground ice layer within the top few meters (Mellon and Jakosky 1993). Shallow ground ice (> 10 cm depth) might persist for as long as ~100 million years (Clifford and Hillel 1983). Recent models suggest diffusive loss of subsurface ice to the atmosphere may be low (Weiss and Head 2017), but observations linking subsurface and surface ice, as well as their interaction with the atmosphere, do not exist.

Mapping meter-scale vertical profiles of subsurface ice distribution and searching for temporal changes will allow us to understand how volatiles currently move between the subsurface, surface, and atmosphere. This has important consequences for the evolution of Mars' cryosphere and climate.

Question 2: How does the Martian lower-middle atmosphere respond on meso- and global scales to the diurnal and seasonal cycles of insolation?

Our present understanding of Mars' weather is shaped by three aerosols: dust, H₂O ice, and CO₂ ice. Each has important radiative effects (and thermodynamic effects for the ices) throughout the lower and middle atmosphere (0–100 km) at meso- (~10² km), synoptic (~10³ km), and planetary (~10⁴ km) scales; connections to climate cycle over geological timescales, and link to extreme and potentially hazardous weather systems. Dust, H₂O ice, and CO₂ ice clouds are the most obvious manifestations of Mars' weather: they shape and are shaped by atmospheric circulations that have been mostly invisible to past and current observations.

From measurements of the temperature structure (Conrath et al. 2000, McCleese et al. 2010), simulations (Haberle et al. 1993, Forget et al. 1999, Conrath et al. 2000, Rafkin et al. 2002, Hollingsworth and Kahre 2010), visible images of

dust storms, and scattered surface measurements (Newman et al. 2017), we can infer the existence of jet streams, extratropical cyclones/fronts, orographic spiral circulations, crater circulations, and mesoscale convective systems. In addition, physical modeling of present day Mars climate dynamics has improved in its ability to represent water and dust cycling over the last decade (e.g., Navarro et al. 2014, Wang et al. 2018, Bertrand et al. 2020, Newman and Richardson 2015, Neary et al. 2020). However, these model improvements were driven by the need to reproduce new types of spacecraft observations (particularly expanded vertical profiling of temperature, dust, and water as vapor and ice). Indeed, modeling the circulation and/or dust and water fluxes throughout the seasonal cycle—including during large dust storms—relies on prescribed dust and/or water distributions. Models that are not yet sophisticated enough to explicitly simulate these distributions physically, partly because simulated winds are not accurate. As a consequence, using these models to infer the current circulation without a proper validation with direct wind data poses significant challenges. At the same time, using these models to investigate past climates with different orbital parameters is even more challenging. Therefore, measurements of winds in the lower and middle atmosphere along with higher spatial and temporal vertical profiling of the aerosol distribution are necessary to validate these model inferences, understand the movement of water and dust around the planet, evaluate present-day Mars meteorological hazards, and understand their analogies to Earth meteorology.

Martian dust aerosols chiefly absorb short-wavelength solar radiation. Lifting (“emission” in terrestrial terminology), transport, and sedimentation (“deposition”) of dust are thought to influence the variability of the lower atmospheric circulation on diurnal, seasonal, and inter-annual time scales (Newman et al. 2002, Montabone et al. 2005, Lewis and Barker 2005, Wilson et al. 2008, Guzewich et al. 2016, Guzewich et al. 2014). Snapshot visual imagery, infrared sounding targeting climate questions, and the Mars Orbiter Laser Altimeter (Heavens 2017) have exposed the tremendous diversity and potential menace of dust storms. Dust storms are capable of significant expansion in a few hours

and of generating deep convective clouds with altitudes of at least 80 km (Clancy et al. 2010, Heavens et al. 2015, Heavens et al. 2018). However, dust storms come in many shapes and sizes that, at a minimum, would present visibility hazards to future human explorers. Some resemble rain and snow-producing weather systems on Earth while others have no obvious Earth analogs (Kahn 1984, Kulowski et al. 2017).

Although we now know that the peak dust concentration of a dust storm can span two orders of magnitude, we know little about their thermal or aerosol structure at the horizontal, vertical, and temporal length scales resolved by Earth weather forecast models; and, of course, we know absolutely nothing about the wind field within these systems. Very recent observations from orbit have pointed out large diurnal variability in atmospheric dust content during regional and global dust events, motivating monitoring throughout the diurnal cycle to understand the connection between dust and circulation at this timescale (Wu et al. 2020, Kleinböhl et al. 2020).

The meteorological significance of Mars' water ice clouds is also underexplored. Water ice clouds absorb and emit infrared radiation, but mainly reflect in the visible. This affects the behavior of Mars' thermal tides (Wilson et al. 2008, Wilson et al. 2007, Steele et al. 2014, Wilson and Guzewich 2014, Kahre et al. 2015, Mulholland et al. 2016). As the tops of thick water ice clouds cool at night, they can become unstable and be an important agent of convective mixing in the lower atmosphere (Spiga et al. 2017) and consequently may cause potentially hazardous, ice-laden currents of air to descend to the surface. This hazardous phenomenon is only known from individual observations at the 200 km scale, far above the length scale of snow squalls or downbursts on Earth.

At the winter pole, nights can be so cold that CO₂, the principal atmospheric constituent, condenses into precipitating ice clouds in tandem with direct deposition of CO₂ ice onto the polar cap (Colaprete and Toon 2002, Hayne et al. 2014, Hayne et al. 2012). Some of these clouds are convective, driven by the latent heating of CO₂ itself, producing potentially violent squalls that litter the polar cap with fresh, poorly emissive CO₂ snowfall. Condensation and sublimation of

clouds affect the thermodynamic budget of the cap, while re-emission of infrared radiation by high clouds affects its radiative balance. Snowfall and dust deposition affect the cap's radiative balance even in the sunlit months by modifying its albedo and emissivity (Hayne et al. 2014, Hayne et al. 2012). Latent heat released during the polar nights by CO₂ condensation is thought to maintain the very unstable shape of the Martian polar vortices (Toigo et al. 2017). However, all current information we have about vortex dynamics comes from indirect data gathered by numerical simulations, with no direct observation to validate against.

Because of Mars' relatively short radiative relaxation timescale compared with Earth (~1 day vs. ~1 month), the diurnal cycle of insolation shapes Martian weather more than on Earth (Read et al. 2015). This diurnal meteorological variability argues for observations spanning the diurnal cycle. However, to date, most measurements have been fixed in local time, or have spanned different local times but at different locations over many sols, leaving major questions unanswered. As an example, Figure 1-3 demonstrates how difficult it is to understand the dynamics of a dust storm if observed by one single polar orbiter compared with full-disk (synthetic) observations by an areostationary satellite. A dust storm during its expansion phase can grow a factor of 10–20 in

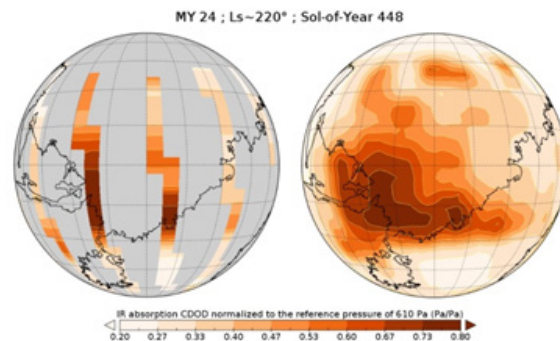

Figure 1-3. The left panel shows a regional dust storm as seen by a single Sun-synchronous polar orbiter, while the right panel represents a synthetic view of the same storm from areostationary orbit. Both panels use vertical perspective projections with a center distance of 6.03 Mars radii. Infrared opacity data are from Mars Global Surveyor (MGS)/Thermal Emission Spectrometer (TES). Grey areas imply missing data. The storm in the right panel is reconstructed following the methodology detailed in Montabone et al. (2015).

area in a week (Cantor 2007) so that a single polar orbiter is only able to observe pieces of it asynchronously. Only a reconstruction of the general characteristics of a storm, carefully made using a week's worth of polar data, can provide a satisfying, albeit approximate picture of how the dust storm really developed.

Moreover, fixed local time measurements and limited understanding of weather systems that mobilize and transport dust have presented a challenge for data assimilation in Mars general circulation models (MGCM) (Lee et al. 2011, Zhao et al. 2015, Navarro et al. 2017). Data assimilation is a set of formal statistical techniques widely used in Earth weather forecast modeling that use observations to constrain model behavior and better resolve the true state of the atmosphere at a particular time. In addition to improving weather prediction, data assimilation can be used to trace the past trajectory of air masses and thus could help discover the sources of mysterious trace gases like methane. However, improvements in both model physics parameterizations and quantity/quality of the assimilated observations will be necessary to achieve these aims.

Determining the dynamics and variability of Mars' meso- to global-scale circulations requires continuous and global observations of Martian aerosols, temperature, and winds throughout the lower and middle atmosphere with respect to longitude, latitude, altitude, local time, and season.

Question 3: How does coupling with the lower atmosphere combine with the influence of space weather to control the upper atmospheric system and drive atmospheric escape?

Mars' upper atmosphere can be broadly defined as the region where the space weather environment (solar extreme ultraviolet (EUV), solar wind, and solar storms) is an important driver of structure and dynamics. The thermosphere begins at the homopause (~100–120 km), above which neutral species have separate mass-dependent scale heights. It extends to the exobase (~200 km), above which collisions no longer dominate particle motion. Above the exobase is the tenuous exosphere, consisting mostly of atomic species (some fraction of them escaping), and extending out to many Mars radii. Embedded

within the thermosphere and exosphere is the charged and conducting ionosphere, mostly the result of solar EUV photoionization of neutrals. The ionosphere and the planet's patchwork of crustal magnetic fields together form a complex obstacle to the solar wind, resulting in induced magnetic fields, electric fields, and highly variable plasma flows.

These interconnected regions form the "upper atmosphere system" i.e., the reservoirs from which, and the channels through which, atmospheric escape has dramatically reshape the climate throughout Martian history (Jakosky et al. 2018).

Thermosphere Dynamics. The basic composition and structure of the thermosphere has been observed (e.g., Mahaffy et al. 2015), to show seasonal and solar cycle variations that roughly match global models after significant averaging (Bougher et al. 2017, Jain et al. 2015). The dynamics of the thermosphere are dominated by atmospheric waves, ranging from small-scale gravity waves (Yiğit et al. 2015) to global tides (Liu et al. 2017, England et al. 2016). These waves impact the dynamics, energetics, and composition of this region, all of which influence atmospheric escape. The character of these waves appears to change as they propagate upward from the homopause through the thermosphere (Yiğit et al. 2015), but how these waves drive dynamics and deposit energy at high altitudes remains unknown.

The limited set of in situ wind measurements by Mars Atmosphere and Volatile Evolution (MAVEN)-Neutral Gas and Ion Mass Spectrometer (NGIMS) (Mahaffy et al. 2014) from ~140 to 240 km (Benna et al. 2019, Roeten et al. 2019) has begun to reveal wind patterns, but the observed variations of 100–200 m/s over ~4 hours (as large as the mean winds themselves) cannot be explained by current atmospheric models (Figure 1-4).

Such winds, as well as density variations caused by waves, can affect aerobraking and entry, descent and landing (EDL) of spacecraft.

The generation, propagation, and dissipation of atmospheric waves between the surface and the thermosphere remain unknown and require systematic, simultaneous measurements of winds and density structures over a broad range of altitudes.

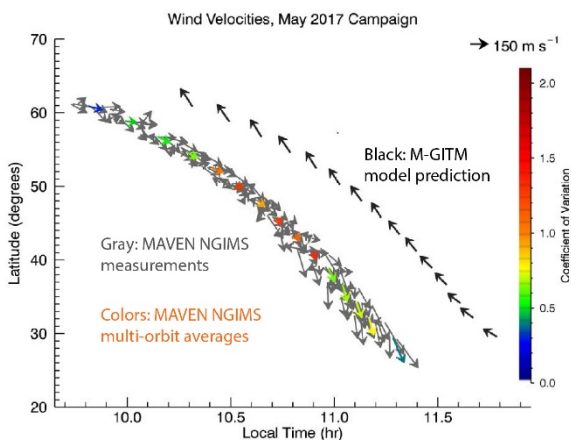

Figure 1-4. Dynamics in Mars' thermosphere are poorly understood. Very sparse in situ MAVEN wind data is highly variable, often disagreeing completely with leading models (Roeten et al. 2019). Comprehensive remote wind measurements are needed.

Lower-Upper Atmosphere Connections.

Evidence now suggests that the lower and upper atmospheres of Mars are more closely connected than previously realized (Figure 1-5). First, the exospheric atomic hydrogen (H) density and associated escape rate varies by a factor of 10-20 with season (Chaffin et al. 2014, Clarke et al. 2014, Bhattacharyya et al. 2015), with the highest densities and rates near perihelion. Meanwhile, the middle atmospheric water abundance, which responds strongly to dust events (Fedorova et al. 2018, Vandaele et al. 2019), is correlated with this H escape (Heavens et al. 2018), with models suggesting that this water could be the main factor driving the escape (Chaffin et al. 2017, Shaposhnikov et al. 2019, Neary et al. 2020).

Despite this, more information is needed to distinguish between proposed mechanisms, e.g., upslope winds (Rafkin 2012), fast-moving dust clouds (Spiga et al. 2013), or sophisticated dust-ice microphysics (Navarro et al. 2014). Adding to these complexities is the multi-dimensional nature of the climate system, which can exhibit different transport mechanisms and patterns at different altitudes, latitudes, longitudes, local times, and seasons.

Second, dust activity in the lower atmosphere appears to be connected to significant depletion of atomic oxygen (O) in the thermosphere (Elrod et al. 2019). Atomic O mediates the conversion of the primary ionospheric ion CO_2^+ into the dominant ion O_2^+ , which dissociatively

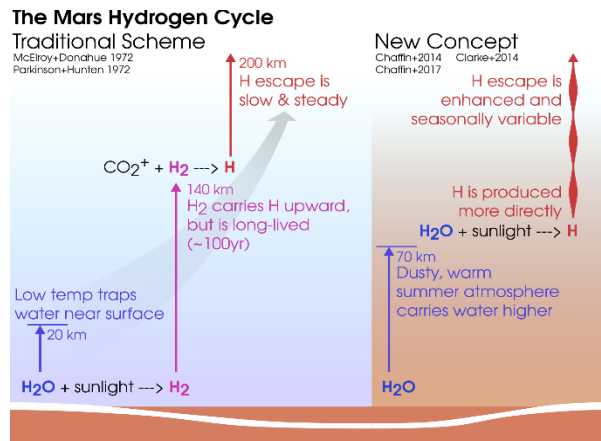

Figure 1-5. Mars' upper atmosphere responds strongly to lower atmospheric dust forcing. H concentrations and escape rates increase while O decreases, and the global circulation is affected by even regional storms, i.e., Mars' evolution is closely coupled to climate, but the mechanisms that govern this coupling remain a mystery due to the lack of global scale coordinated observations of the lower and upper atmosphere.

recombines ($\text{O}_2^+ + e^- \rightarrow \text{O} + \text{O} + E_{\text{kinetic}}$) to produce a hot O exosphere, the dominant source of escaping O today (Lillis et al. 2017).

Synoptic tracking of lower atmospheric dust loading, middle atmospheric water abundance, upper atmospheric H and O response, and the temperature structure at all altitudes across multiple dust events is required to decipher the processes by which the lower atmosphere drives the upper atmosphere and escape.

Ionosphere structure and dynamics. Mars' ionosphere is complex ionized region primarily produced by solar EUV, but also influenced significantly by several other factors: crustal and induced magnetic fields, solar x-rays, cosmic rays, atmospheric waves, and ambipolar electric fields (Figure 1-6). Below 200 km altitude, the collision rate is high enough to maintain photochemical equilibrium. The dayside ionosphere broadly agrees with theory (Benna et al. 2015, Vogt et al. 2017), with densities higher and temperatures lower where plasma is trapped within “miniature magnetospheres” over strongly magnetized crust (Andrews et al. 2015, Flynn et al. 2017). The nightside ionosphere is complex and governed by transport from the dayside and ionization by precipitating electrons (Girazian et al. 2017, Girazian et al. 2017, Adams et al. 2018, Lillis et al. 2018).

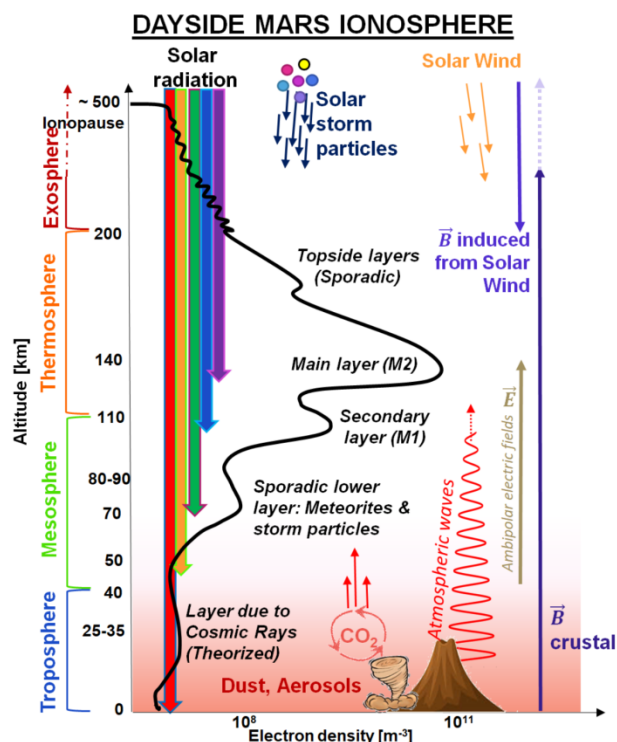

Figure 1-6. Mars’ ionosphere is embedded mostly within the upper atmosphere and is influenced by a number of planetary and space weather factors. Regular global measurements of the ionosphere and space weather environment are necessary to understand the processes driving its variability, which disrupts communications and global positioning.

Above the photochemical region is the highly variable “upper ionosphere”, where plasma transport dominates and most ion escape originates. Ions in this region are heated by plasma waves from in the solar wind (Collinson et al. 2018, Fowler et al. 2017, Fowler et al. 2018a, Fowler et al. 2018b) and accelerated by electric fields (Akbari et al. 2019, Xu et al. 2018) and magnetic tension forces. The interplanetary magnetic field (IMF) drapes around the planet, driving a strong hemispheric asymmetry in the ionosphere and the motion of escaping ions (Dubinin et al. 2018). These ionospheric dynamics can also disrupt communication and navigation on Mars (see Section 1.2).

Any single spacecraft cannot be in two places at once, which is the minimum needed to characterize the real-time response of the ionosphere to variable forcing by the solar wind. This has introduced significant, unquantifiable uncertainty in studies to date. Further, in situ observations have been limited to widely-

separated swaths (one per orbit, every ~4.5 hours), yielding insufficient coverage to determine the large-scale response of the ionosphere to dynamic events.

To reveal how the ionosphere responds to space weather, this weather and the response of global distribution of ionospheric plasma must be measured at least hourly.

New perspectives on Mars’ magnetosphere. Mars has a unique “hybrid” magnetosphere because it shares properties of both unmagnetized planets (e.g., Venus) and magnetized planets (e.g., Earth, Jupiter), as shown in Figure 1-7.

Multi-point plasma missions have revolutionized understanding of the terrestrial magnetosphere (Paschmann and Daly 1998, Gustafsson et al. 2001, Angelopoulos et al. 2008, Lanzerotti 2013, Fuselier et al. 2016). Similarly, coordinated two-point measurements would transform our understanding of Martian plasma dynamics, including ion escape (Paschmann and Daly 1998). For example, time-separated measurements across the same plasma boundary or within the same volume allow us to determine how the boundary moves/changes or how conditions within that volume change. Spatially-separated simultaneous measurements made

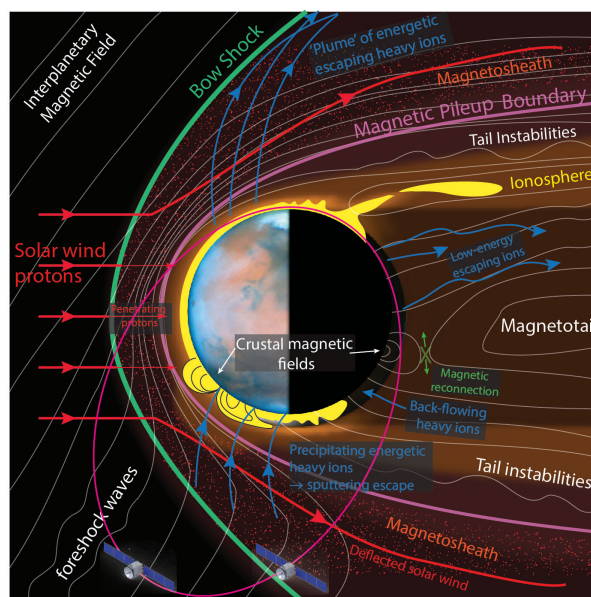

Figure 1-7. Multi-point plasma measurements are needed to understand mass and energy flows throughout Mars’ uniquely rich and interconnected hybrid magnetosphere.

within a plasma region unambiguously reveal how conditions vary over a range of spatial scales. Simultaneous measurements of the upstream solar wind and plasma conditions in the Martian magnetosphere allow us to observe its response to solar wind disturbances in near real time (Ma et al. 2014).

Leveraging success of terrestrial multi-point plasma missions, simultaneous measurements from multiple platforms are needed to reveal the dynamic response of the magnetosphere to the highly variable space weather environment.

1.2 Preparation for Human Exploration of Mars

Human missions to Mars, including establishing a sustained human presence, will require explorers to foresee and mitigate hazards, identify and utilize resources, track their location, and communicate with Earth. Water—essential for both life support and propellant synthesis—is stored as ice at mid-latitudes and the poles. In order to be utilized by humans, sites with ice shallow enough to be easily accessible must be characterized. The Human Precursor Strategy Analysis Group (P-SAG) (Beatty et al. 2012) prioritized identifying ice and its depth variation within the first meter (activities D1-5, D1-6).

Dust climatology observations (B1-1) and validation of Mars atmospheric models (A2-1) are too limited to confidently design human missions to the planet. P-SAG prioritized observations of temperature, wind, and aerosols, at all local times and with 10-km horizontal resolution, as well as comprehensive observations of dust activity (A1-1, A1-2, A1-3).

Charged particle radiation can penetrate spacesuits and habitats to cause cancer and even radiation sickness amongst human crews in Mars orbit (Jakosky et al. 2015). Despite past measurements (Zeitlin et al. 2004), we have not characterized the energetic particle radiation environment over a full solar cycle and Mars' range of heliocentric distances (1.38–1.62 AU). Such characterization is important to forecast expected crew radiation dose in Mars orbit.

A robust communication and positioning infrastructure capable of accurate location, high data volume and short latency between surface

assets, orbiters, and Earth should be in place to ensure effective decision-making in human exploration of Mars. The very satellite platforms that can make strategic measurements of Mars aimed at human exploration are the logical testbed for this infrastructure. One aspect of this infrastructure will be reliable radio transmission, which we expect initially will be the routine means of communication at Mars and then to Earth. Mars' ionospheric variability must be characterized to determine its likely effect on positioning and communication (Mendillo et al. 2004). In addition, we must determine the best way orbiters and surface assets can coordinate to maintain near continuous contact with Earth.

- *To plan for human missions, we must know where shallow water ice can be found.*
- *To plan for humans to safely reach, explore, and return from the Martian surface, we must monitor dust continuously and simultaneously in order to validate assimilative forecasting models.*
- *To protect astronaut health, we need to measure the radiation hazard in orbit over a full solar cycle.*
- *To prepare effective communication strategies, ionospheric effects on communication and positioning must be understood and Deep space optical communication (DSOC) with delay tolerant networking (DTN) must be vetted as options for supporting human exploration."*

1.3 MOSAIC Goals, Objectives, and Relevance

The MOSAIC mission is a strategic constellation of ten spacecraft that addresses these high-priority science and exploration goals. MOSAIC's has two main goals: **Goal I** is to *“Understand Mars’ present day climate processes and their inter-connections, from the sub-surface to the solar wind,”* and **Goal II** is to *“Identify hazards, characterize resources, and demonstrate technologies to enable the Human Exploration of Mars.”* These Goals are addressed through the achievement of several Objectives which, in turn, are fulfilled by different combinations of eight investigations. Section 1.4 (FO 1-1) traces Goals to investigations (Table 1-1) and Investigations to specific measurement requirements (Table 1-2)—both tables are part of the FO 1-1.

MOSAIC's unprecedented investigations will both ensure the safe human exploration of Mars, and revolutionize our understanding of the processes by which matter and energy move within and between the reservoirs of the Martian climate system to drive current climate and past climate evolution.

Relevance to MEPAG. MOSAIC addresses key Mars Exploration Program objectives, as described in the MEPAG Goals Document (Banfield et al. 2020) under several goals, primarily Goals II and IV, relating to climate and human exploration, respectively.

Goal II “Understand the processes and history of climate on Mars”:

- A1. Constrain the processes that control the present distributions of dust, water, & carbon dioxide in the lower atmosphere, at daily, seasonal & multi-annual timescales.
- A2. Constrain the processes that control the dynamics and thermal structure of the upper atmosphere and surrounding plasma environment.
- A4. Constrain the processes by which volatiles and dust exchange between surface and atmospheric reservoirs.
- C3. Determine present escape rates of key species and constrain the processes that control them.

Goal IV “Prepare for Human Exploration”:

- A1. Determine the aspects of the atmospheric state that affect orbital capture and EDL for human scale missions to Mars.
- B3. Assess the climatological risk of dust storm activity in the human exploration zone at least one year in advance of landing and operations.
- C2. Characterize potentially extractable water resources to support In Situ Resource Utilization (ISRU) for long-term human needs.

In addition, the 2019 report from the MEPAG Ice and Climate Evolution Science Analysis Group (ICE-SAG) identified weather-dedicated Mars orbiter(s) as a top priority for future study (Diniega and Putzig 2019).

Relevance to 2013–022 Decadal Survey. The most recent Decadal Survey (Council 2011) specifically calls for a mission like MOSAIC, stating:

“Fundamental advances in our understanding of modern climate would come from a complete determination of the three-dimensional structure of the Martian atmosphere from the surface boundary layer to the exosphere. This should be performed globally, ideally by combining wind, surface pressure and accurate temperature measurements from landed and orbital payloads.”

Relevance to NASA human Exploration. MOSAIC would fulfill seven high-priority Strategic Knowledge Gap-Filling Activities (GFAs) to enable human exploration, as identified by P-SAG (Beatty et al. 2012). Investigation 1 fulfills D1-5 and D1-6 (subsurface ice), Investigations 2 and 3 address A1-1 (global temperature field), A1-2 (global aerosol profiles), A1-3 (global wind profiles), and B1-1 (dust climatology). Investigation 4 completes A1-1 and A1-3, but for the upper atmosphere.

Appendix B.1 contains significantly more information on MOSAIC's:

- ***Rationale***
- ***Scientific study team and exercise***
- ***Investigations***
- ***Required measurements***
- ***Instruments and their accommodations***
- ***Both synergy and modularity with respect to other existing and planned Mars missions.***

1.4 Science Traceability (FO 1-1)

Table 1-1

MOSAIC GOALS	KEY MOTIVATING QUESTIONS	MISSION OBJECTIVES	INVESTIGATIONS																	
			1. Ice Distribution	2. Atmosphere Structure	3. Atmosphere Diurnal Behavior	4. Thermosphere	5. Ionosphere	6. Exosphere & Neutral Escape	7. Plasma & Ion Escape	8. Space Weather	9. Technology Demonstrations									
SCIENCE OBJECTIVES																				
I. Understand Mars's present day climate processes and their inter-connections, from the sub-surface to the solar wind.	How do volatiles move between the subsurface, surface, and atmosphere?	A Characterize volatile cycling between the subsurface, surface and atmospheric reservoirs.	•	•	•															
	How does the Martian lower-middle atmosphere respond diurnally, on meso- and global scales, and its geographic, diurnal, and seasonal variability.	B Characterize the structure and dynamics of the Martian lower-middle atmosphere on meso- and global scales, and its geographic, diurnal, and seasonal variability.		•	•															
	How does coupling from the lower atmosphere combine with the influence of space weather (solar wind, SEPs, and solar EUV) to control the upper atmospheric system** and drive atmospheric escape?	C Correlate variability in the thermosphere, ionosphere, and escape rates to: Conditions in the lower-middle atmosphere. The space weather environment.		•	•	•	•	•	•	•	•	•	•	•	•	•	•	•	•	•
			D Characterize fields and plasma flows in the upstream solar wind and throughout the magnetosphere and upper ionosphere, separating spatial from temporal variability.																	
EXPLORATION OBJECTIVES																				
II. Identify hazards, characterize resources, and demonstrate technologies to enable the Human Exploration of Mars.	How, where, and when can future astronauts access extractable water ice resources?	Characterize potentially extractable water ice resources to support in situ resource utilization.	•																	
	With what degree of accuracy can Martian weather be forecast, for operational purposes?	Characterize the Mars atmospheric state with sufficient spatial sampling and cadence to allow accurate data assimilation and weather forecasting.		•	•															
	How will mesospheric and thermospheric winds affect aerobraking spacecraft?	Characterize neutral winds in the mesosphere and lower thermosphere (60 km-130 km) and their variability with lower atmospheric conditions and solar activity.				•														
	How will space weather effects on the Mars ionosphere affect surface-surface and surface-orbit communications?	Characterize the Mars ionospheric state and variability sufficiently to determine its likely disruptive effect on communications and positioning.					•	•												
	How will energetic particle radiation affect astronauts in Mars orbit?	Characterize the environment of penetrating ions (>10 MeV/nuc) at 1.38-1.62 AU with season and solar cycle.																		•
	Can reliable high-bandwidth Earth-Mars communication be maintained?	Demonstrate delay-tolerant networking, Deep Space Optical Communication (DSOC), and relay communication between Mars surface, Mars orbit, and Earth.																		•

** "Upper atmosphere system" refers to the interconnected Martian thermosphere, ionosphere, exosphere, and magnetosphere.

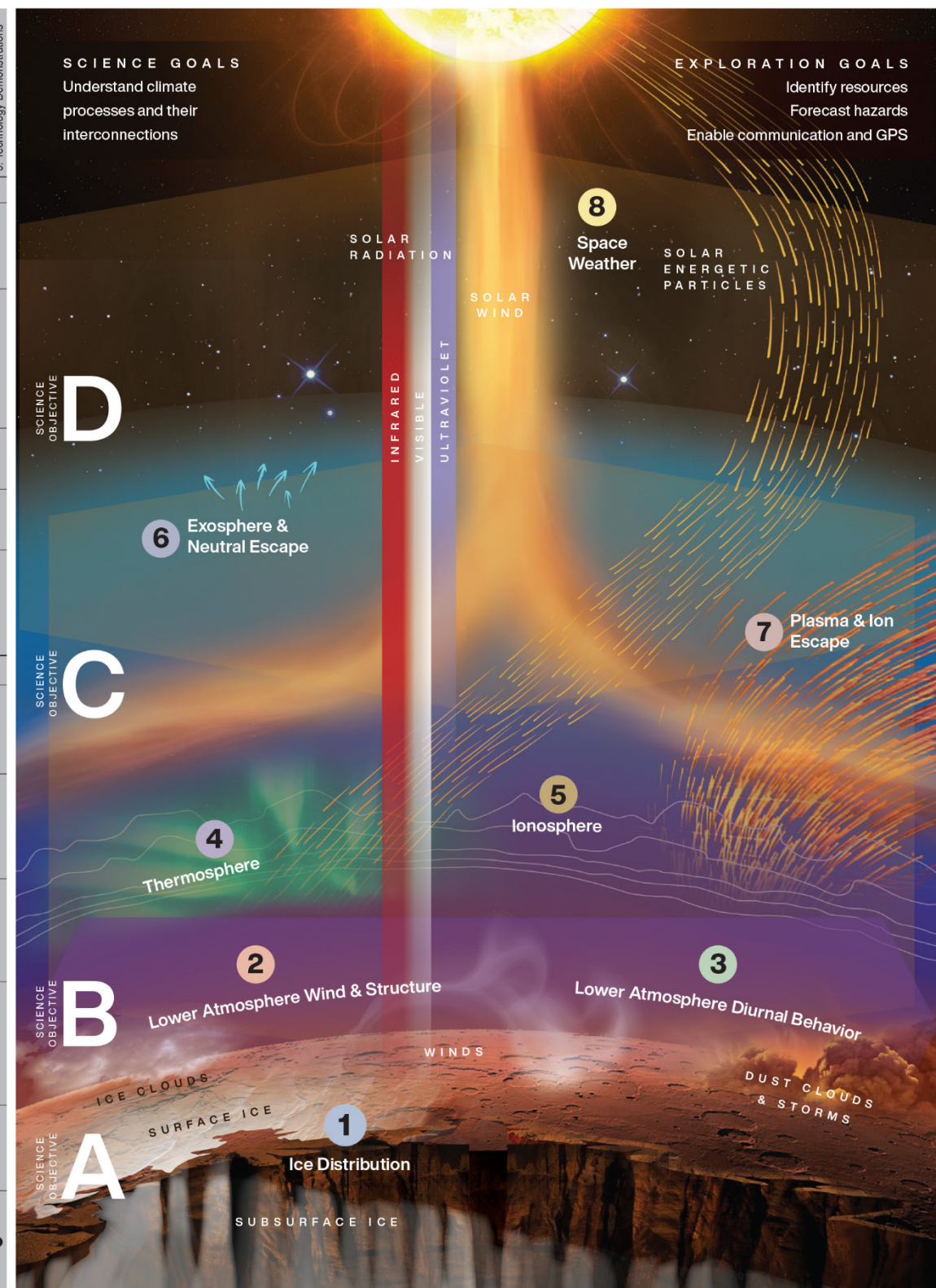

Table 1-2

INVESTIGATIONS	MEASUREMENTS	INSTRUMENTS*	FUNCTIONAL REQUIREMENTS
1 Measure the three-dimensional distribution of ice from the surface to 10 m below.	• Subsurface ice abundance derived from dielectric constant • Surface thermal inertia • Surface water ice & albedo	• P-band SAR & Sounder • Visible imager	<400 km circular near-polar orbit Hi mass and power
2 Measure the geographic and altitude distribution of pressure, winds, aerosol concentrations, water vapor, ozone, and temperatures in the Mars lower and middle atmosphere.	• Vertical profiles (0-80 km) of: temperature, winds, dust, H2O and CO2 ices, H2O vapor, O3 • Surface temperature and pressure	• Limb-Nadir TIR radiometer • Wind LIDAR • Sub-mm sounder	<400 km circular near-polar orbit
3 Measure the complete diurnal and geographic behavior of the atmosphere and evolution of Martian dust and ice clouds.	• Visible and/or UV imagery of clouds/hazes • Column opacities/abundances of dust, H2O, ozone, and CO2 ice	• Nadir TIR radiometer • Visible imager • Near IR spectrometer	Four Areostationary orbits, spaced evenly in longitude
	• Temp/pressure profiles 0 - 40 km • Vertical profiles (0-80 km) of temperature, dust, H2O and CO2 ices, H2O vapor, spread evenly across 8 local times	• Limb-Nadir TIR radiometer • Radio occultation • Near IR spectrometer	Four <400 km circular near-polar orbits, spaced evenly in local time
4 Measure the global 3-D composition, structure, and winds in Mars's thermosphere.	Vertical profiles (90 - 200 km) of: • Horizontal wind velocity • Density and temp. of O, CO, N2, CO2	• Wind Doppler interferometer • FUV/MUV spectrograph	<400 km circular near-polar orbit
5 Measure the global 3-D structure of Mars ionosphere.	Vertical profiles (90-400 km) of: • electron density • electron temperature	• Langmuir probe • Radio Occultation	< 400 km circular AND elliptical orbits < 170 km periapse
6 Measure the 3-D density and temperature structure of Mars's hydrogen and oxygen exospheres.	Vertical profiles (200 - 30,000 km) of: • O density and temperature • H density and temperature	• FUV/EUV spectrograph	Circular orbit >10,000 km altitude
7 Measure (from multiple viewpoints) fluxes of light and heavy ions, magnetic field and topology, plasma waves, and electric fields within and between all regions of Mars' hybrid magnetosphere.	• Magnetic field • Electric field • Suprathermal electron pitch angle distributions → magnetic topology • Ion mass, energy, and angular distributions. • Thermal electron temperature and density • Plasma waves	• Fluxgate magnetometer • Search coil magnetometer • Ion energy/angle/mass • Electron energy/angle • Electric fields	2 spacecraft Orbit inclination ~75°, Apoapsis >6000 km, <170 km periapse
8 Measure magnetic field and plasma conditions in the upstream solar wind, and solar extreme ultraviolet irradiance.	• Magnetic field • Solar wind density, speed, temp • Solar EUV irradiance • Solar Energetic Particle Flux	• Fluxgate Magnetometer • Ion energy/angle • Electron energy/angle • Extreme UV monitor • Energetic ion/electron	2 spacecraft Circular orbit >10,000 km altitude
9 Demonstrate delay-tolerant networking (DTN), high-performance onboard processing, high-bandwidth optical Earth-comm, and continuously available relay communication between Mars surface and Earth via relay.		• Electra/Relay antennas • Optical communication • DTN protocols	All

* Refer to 3.1, B.1.4, D.1 for detailed information on instruments.

2 High-Level Mission Concept

The MOSAIC constellation consists of ten spacecraft in three orbit types and efficiently returns at least two Mars years of first-of-a-kind simultaneous science, unraveling Mars' present day interconnected climate processes.

MOSAIC consists of eight science investigations carried out by 22 unique science instruments (49 individual instruments total), hosted on ten individual spacecraft that share a single launch vehicle. These ten spacecraft are delivered to three different orbit types: near-polar sun-synchronous, inclined elliptical, and areostationary (FO 2-1).

The science requirements in Section 1.4 necessitate simultaneous measurement by multiple spacecraft in different orbits. “Platform” refers to a modular building block that can support similar payloads and orbit types; the six MOSAIC platforms are Mothership, Polar, Elliptical, Areo Carrier, Areo SmallSat A, and Areo SmallSat B (see FO 2-1). Multiple copies of some of these platforms are included to obtain adequate simultaneous coverage.

The same approach was used for the 22 unique instruments that traced to 49 total instruments in the entire constellation (see FO 2-1).

2.1 Overview

The MOSAIC constellation consists of ten spacecraft in six orbital planes about Mars. The six different platforms range in size from a large orbiter to sub-100 kg smallsats:

- **Mothership:** This platform carries out key investigations in ice and winds from a circular 300 km, sun-synchronous orbit, along with serving as a data relay for the small satellites it delivers. It is a large, SEP-powered spacecraft carrying a 6-m radar antenna, large flexible solar arrays, and a 3-m articulated high-gain antenna. The propulsion system is sized to also carry the Polar and Elliptical platforms (attached via the Evolved Expendable Launch Vehicle (EELV) Secondary Payload Adapter (ESPA) ring) and drop them off on the way to its final orbit.
- **Polar:** The primary objective of the Polar platform satellites is to obtain simultaneous measurements at multiple Local Solar Times

(LST). Three small (< 100 kg) spacecraft will be placed in sun-synchronous orbits with ascending nodes spaced at 3-hour intervals in LST. Together with the Mothership, observations can continually span the globe centered at 6 a.m., 9 a.m., 12 p.m., and 3 p.m.

- **Elliptical:** Two Elliptical platform satellites in a 150 km × 6000 km × 75° precessing elliptical orbit will allow for repeated passes through the upper atmosphere, ionosphere, and magnetic field at multiple local times and geometries. These two spacecraft will spin with key instruments hosted on long booms and are spaced by ~30° along the same orbit in a “pearls on a string” formation, allowing for dynamic measurements of the same regions and across boundaries.
- **Areo Carrier and Areo SmallSats A and B:** Similar to geostationary orbiters at Earth, the areostationary vantage point allows the spacecraft to remain fixed over an equatorial ground point and have a constant view of one hemisphere of Mars. Four spacecraft have nearly complete overlapping views of the surface at all times. The largest spacecraft has a SEP system to carry and deliver the other three. The smaller spacecraft are separated by 90° in longitude and complete the diurnal view for key observations.

Constellation Delivery Concept

Figure 2-1 illustrates one potential method to deliver the full baseline MOSAIC constellation on a single launch. The full stack mass is such that it could be launched on a Falcon Heavy Recoverable or equivalent. In its launch configuration, the mothership would sit atop two ESPA rings (Figure 2-2).

The Areo Carrier and Areo SmallSats A/B satellites attach to the lower ring whereas the upper ring carries the elliptical and polar satellites on five ports. Shortly after launch to a low-energy escape trajectory, the delivery sequence is as follows:

1. The Areo Carrier, along with the Areo SmallSat A/B platforms, separate (Stop 1a in Figure 2-1) from the lower ESPA ring (which remains attached to the launch vehicle upper stage). The SEP system in the Areo Carrier element propels all four elements to rendezvous with Mars and spiral down to

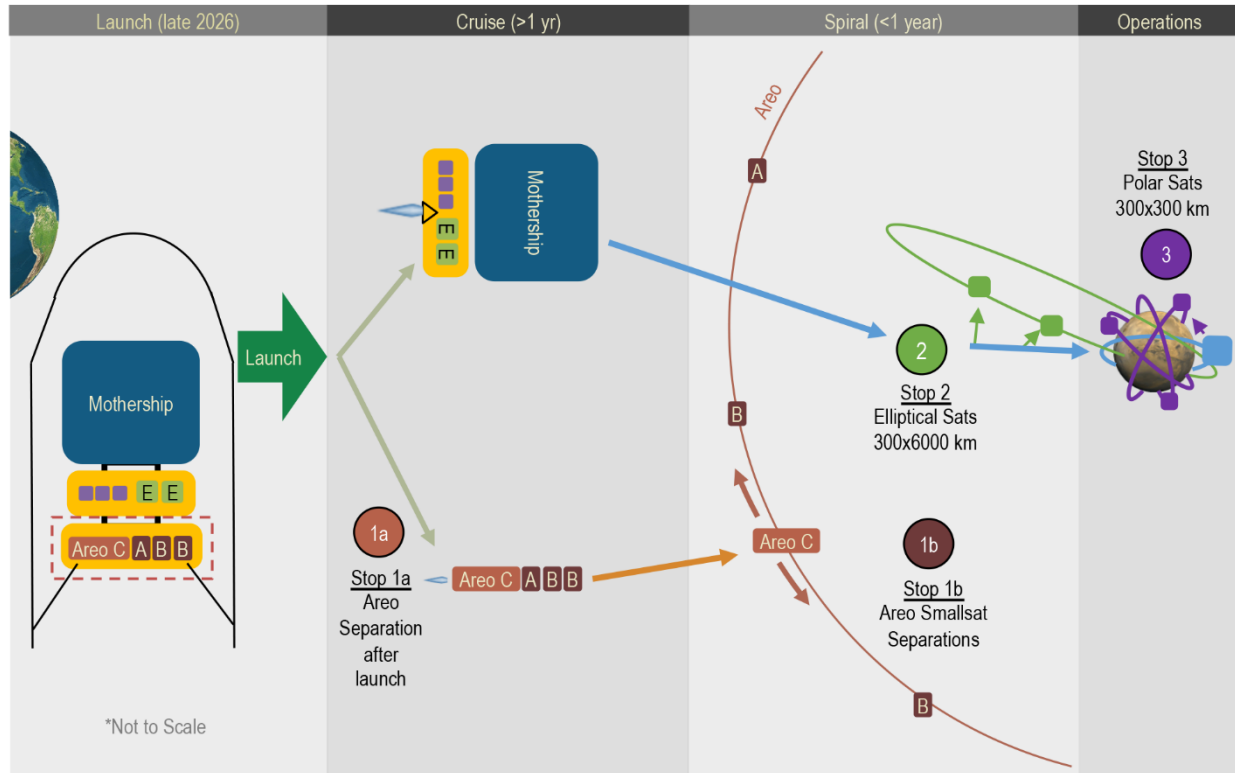

Figure 2-1. Baseline MOSAIC constellation delivery concept.

areostationary orbit. The Areo SmallSat A and B elements then separate (Stop 1b) and utilize small propulsive maneuvers to drift to equidistantly spaced locations around the ring.

2. The Mothership uses SEP to carry the permanently attached upper ESPA ring accommodating the Polar and Elliptical smallsats during cruise. After cruise and spiral down to a $300 \times 6000 \text{ km} \times 93^\circ$ orbit, the Elliptical satellites separate (Stop 2) and use their onboard propulsion to change their inclination to 75° and lower periapsis to 150 km.
3. The Mothership continues its spiral to a 300 km, 3 p.m. LST sun-synchronous orbit, at which point the Polar satellites separate (Stop 3) and change their inclination slightly. This allows them to drift to new ascending nodes (and LST's), where the return to the sun-synchronous inclination.

Scientific investigations may commence as soon as operational configuration and range allow. That is to say that some measurements may be taken during the spiral and/or drifting phases where desirable. Some elements will arrive at their

respective science orbits up to many months before others (see Section 4.1 and Figure 4-1). Each element may begin full operations when ready, but the baseline mission (two Mars years)

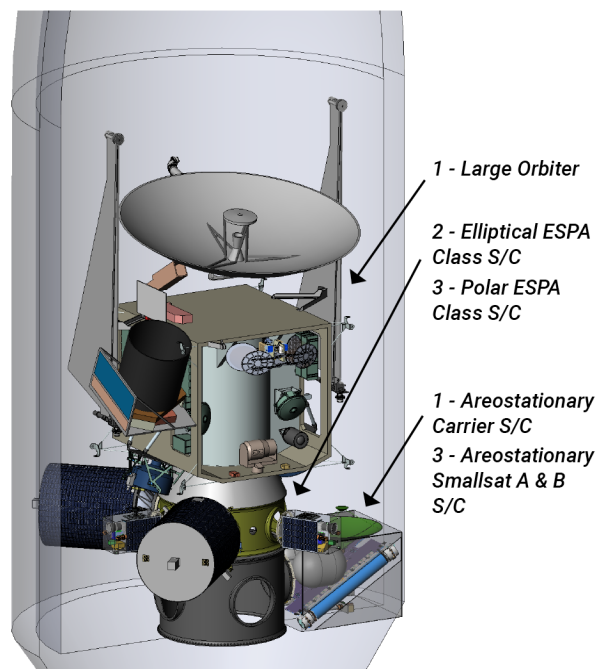

Figure 2-2. MOSAIC constellation launch configuration.

commences when all elements are fully in place, allowing for co-temporal measurements and investigations needed to meet the scientific objectives.

2.2 Concept Maturity Level (CML)

MOSAIC benefits from a large and diverse set of previous Mars orbiter studies (see Appendix E). This study examines areas of the trade space (CML 3, see Table 2-1 not previously looked at in-depth for the combination of science, exploration, technical, and cost for a Mars constellation. Another trend considered in the trade space is the promise of focused science via smallsats. CML 3 A Team analysis and cost work reveals the areas of the trade space that should be examined further across science, technical, and cost. JPL’s Team X produces CML 4 point designs for the most promising areas of the trade space. Additionally, the JPL study team leverages previous and current Mars Program formulation studies to analyze a few other parts of the trade space at CML 3. The resulting range of science and mission possibilities produces useful information for future Mars constellations such as MOSAIC.

Table 2-1. CML helps to describe the maturity of a concept. The MOSAIC PMCS is at CML 3 or 4.

Concept Maturity Level	Definition	Attributes
CML 4	Preferred Design Point	Point design to subsystem level mass, power, performance, cost, risk
CML 3	Trade Space	Architectures and objectives trade space evaluated for cost, risk, performance

2.3 Technology Maturity

Almost all spacecraft subsystems, subassemblies, and components are mature to at least Technology Readiness Level (TRL) 6, and many to TRL 9 (key spacecraft elements shown in Table 2-2). Advances in technologies such as SEP thrusters, power converters, and electronics could reduce mass and overall mission cost. MOSAIC’s payload benefits from technology developments (Table 2-3). Also refer to Section 3.1 for payload, Section 3.2 for spacecraft, Section 4.2 for maturation plans for technologies at TRL 5 or less, and Appendix B for additional detail for select technologies.

Table 2-2. Key spacecraft technologies are ready or soon will be. M-mothership, AC-Areo carrier, AS – Areo smallsat (A or B), E-Elliptical, P-Polar

Spacecraft Element	Technology	TRL
Propulsion – M	SEP thruster SPT 140	6
Propulsion – AC, AS	MASMI thruster	5
Propulsion – E, P	Hydrazine	5
Telecomm – M, AC	TWTA (200 W)	6
Telecomm – M, AC	Universal Space Transponder (UST)	6
Telecomm – AS, P, E	Iris transponder	9
Command and Data Handling (C&DH) – M, AC	Rad 750 Computer	9
C&DH – AS, E, P	Sphinx computer	6
Power – M, AC	UltraFlex solar arrays	6
Power – M, AC	Power Processing Unit (PPU)	6
Mechanical – M, AC	Solar array and High-Gain Antenna (HGA) gimbals	>6
Optical Communication – M, AC	High data rate optical communication to Earth	5

Table 2-3. Key payload technologies are ready, soon will be, or can be with small focused investment.

Payload element	Technology	Performance Increase
Radar and Sounding	P-band Synthetic Aperture Radar (PSAR)/ Sounder	First-of-a-kind at Mars P-band radar and sounder for shallow ice using Earth-proven techniques
Wide angle imager with ultraviolet (UV)/Visible/Near Infrared (NIR)	Mars Atmosphere Volatile and Resource Investigation Camera (MAVRIC)	Increased wavelength resolution by increased number of filters over Mars Color Imager (MARCI)
Wind Light Detection and Ranging (LiDAR)	Mars LiDAR (MARLI)	First-of-a-kind at Mars Doppler wind LiDAR using Earth-proven technique to discriminate atmosphere dust and water ice aerosols
Surface pressure from low Mars orbit and aerostationary	NIR point spectrometer	Flight-ready NIR point spectrometer already used at Earth
Horizontal wind components over all altitudes from 60-150 km	Wind Doppler Interferometer	First-of-a-kind measurements of Mars airglow at 557.7-nm and 1.27- μ m using Earth-proven techniques
Limb-pointed Far-Ultraviolet/Mid-Ultraviolet (FUV/MUV)	FUV/MUV spectrograph	MAVEN Imaging Ultraviolet Spectrometer (IUVS) minor modification
Radio Occultation	Ultra-stable oscillator (USO)	Smallsat version enables occultations to measure electron densities
Ion and Electron spectrum	Ion and Electron spectrometers	Based on THEMIS and MAVEN plasma instrumentation

Table 2-3. Key payload technologies are ready, soon will be, or can be with small focused investment.

Payload element	Technology	Performance Increase
Ion density and electron density and temperature	Langmuire probe	Sized for smallsat
Visible Camera	Chameleon Imager	Commercially available camera for panchromatic and eight-channel visible/NIR
Nadir and limb atmospheric emissions	Mini Mars Climate Sounder (MCS)	Much smaller than Mars Reconnaissance Orbiter (MRO) MCS
Extreme Ultraviolet monitoring	Smaller overall footprint and improved sensitivity optical path	Improved sensitivity over MAVEN

2.4 Key Trades

The number of scientific objectives, instruments, platforms, and mission requirements of the MOSAIC concept lead to a large trade space. There are multiple possible configurations in which the various instruments are delivered and hosted on a wide array of spacecraft elements in any number of orbital planes. The architecture outlined in this section was selected as an optimal compromise among the following key trades:

Number and type of operational orbits. Each investigation (see FO 2-1) is best carried out from a specific range of orbits, ranging from low-circular polar to very distant. Some have very explicit requirements (such as fixed LST, global coverage, or atmospheric sampling) which drive specific orbits, whereas others can be co-hosted provided basic needs are met. This drove us to the smallest set of unique orbits: sun-synchronous, inclined elliptical, and areostationary.

Number and types of platforms. Instruments and elements should be combined onto the minimum number to platforms that meet mission objectives in order to save on costs. This can mean fewer large spacecraft platforms or many small ones. Some measurements necessitate multiple viewpoints and therefore multiple elements. Large instruments must be hosted where more resources (e.g., mass and power) are available. Wherever possible, it is advantageous to minimize the number of unique platforms so as to take advantage of economies of scale.

Launch configuration. With so many spacecraft, it is possible to distribute their

launches over a number of launch vehicles and rideshare opportunities. A key trade to bear in mind is that the prime mission of the MOSAIC constellation commences when all of the elements are in their final orbits and ready to make simultaneous measurements. It was found that the full constellation could be launched from an affordable, dedicated, medium class launch vehicle allowing for launch period flexibility and complete constellation arrival in the same opportunity.

Constellation delivery. At the extremes, each mission element could either be delivered by one master propulsion module, or each could have its own propulsion, making its way from launch to final destination. Between those extremes, there are any number of combinations of elements with larger propulsive capabilities delivering those with smaller or no propulsion. The architecture described here divided the constellation into high and low-Mars orbits, with two larger propulsive elements (Mothership and Areo Carrier) delivering the smaller elements to the Mars system.

Propulsion Type. The choice between traditional chemical propellants and SEP greatly affects the trajectories and overall architecture choices. SEP is much more efficient, providing more ΔV for less propellant. It has other advantages such as no critical events (e.g., Mars Orbit Insertion), flexible launch periods and flight times, as well as extra power available to science and telecom after arrival. On the other hand, the low-thrust can lead to longer flight times and SEP requires much larger power systems.

Telecommunication and data relay architecture. The mothership relays data to Earth (DTE) using Ka-band. The mothership has X-band DTE as backup to Ka-band, and also uses X-band for uplink from Earth to the mothership. The Elliptical and Polar platforms relay data to the mothership using ultrahigh frequency (UHF) links. The mothership also has a UHF/X-band dual frequency link to the elliptical and polar platforms for the purposes of radio science occultations. The Areo Carrier, and Areo Smallsat A and B platforms each send their own DTE using Ka-band.

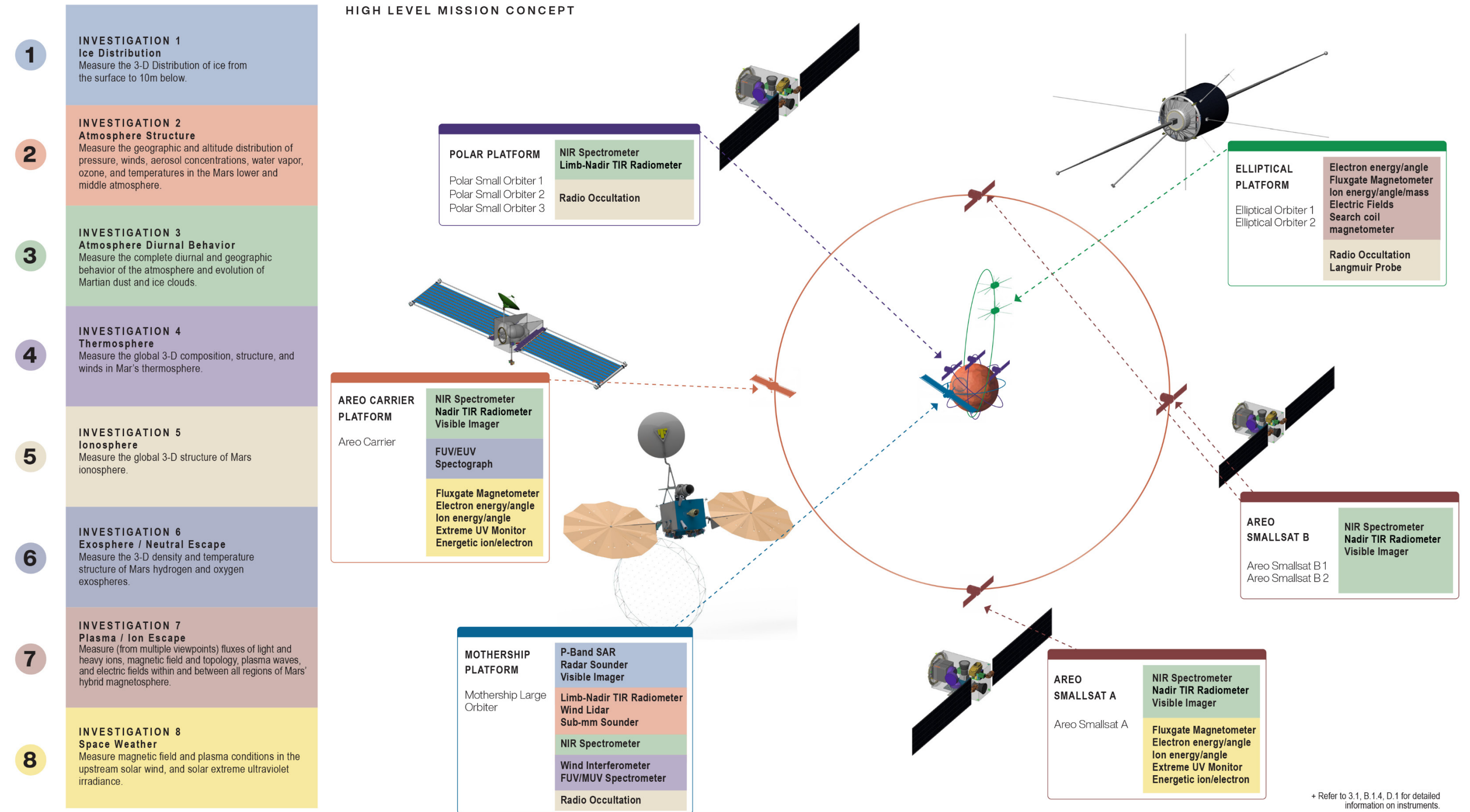

FO 2-1. Shows the baseline MOSAIC overview of the investigations, platforms that host the investigations, launch and cruise to Mars configurations, and the Mars orbits with numbers of platforms in each orbit.

3 Technical Overview

The MOSAIC constellation of six platforms in three orbit types is designed to support understanding Mars’ present day climate processes and their interconnections.

The MOSAIC constellation utilizes two larger “carriers”—one in low Mars polar orbit (called the Mothership), and one in areostationary orbit (called the Areo Carrier), which, in turn, places the other spacecraft in their appropriate orbits (see FO 2-1). The Mothership carries the Elliptical and Polar platforms to Mars, and itself carries substantial science payload. The Areo Carrier delivers the Areo SmallSat A and Areo SmallSat B platforms (Figure 2-1) to orbit, as well as carrying its own suite of instruments. The Elliptical and Polar smallsats in the constellation utilize the Mothership as a data relay to Earth. The Areo Carrier and Areo SmallSats A and B relay their smaller data volumes directly to Earth.

To reduce cost and risk, MOSAIC smallsats are designed to be modular wherever possible. Leveraging similarities between smallsats allows for straight-forward exchange of payloads, resulting in a multi-use spacecraft bus. The constellation could last indefinitely if replenished. Table 3-0 provides a roadmap for more information regarding Instruments, Platforms, Cost, and Risk for the Baseline Constellation and a science descope variant called “Desclope 1.” Note that Baseline and Desclope 1 Constellations only differ by a reduced set of instruments on the Mothership – the rest of the constellation is the same.

Table 3-0. Sections of MOSAIC constellation study report where baseline mission and descope 1 mission information is located.

Description	Baseline Constellation	Desclope 1 Constellation
Instruments	§3.1 Table 3-1 pg. 3-6/7, Appendix B.1.7.3 pg. B-49, Appendix D.2	§3.1, Table 3-1 pg. 3-6/7, Appendix B.1.7.3 pg. B-49
Platforms	§3.1 FO 3-1 pg. 3-4/5, Appendix B.3 and B.4, Appendix D.2	§3.1 FO 3-1 pg. 3-4/5, Appendix B.4
Cost	§5 Tables 5-1, 5-2	§5 Table 5-1, 5-4
Risk	§3.4 page 3-21 & 3-22	§3.4 page 3-21 & 3-22

3.1 Instrument Payload Description

The payloads described are intended as a roadmap to MOSAIC science; in many cases,

there are already-existing reasonable alternative payloads, or others that are in development. Some of these are discussed here, as well as Appendix B.1.4 and Section 4.2; the Study Team anticipates deviations from the point design generated in Team X and the outcome of this study highlights a **high level of flexibility in the ultimate design**.

Furthermore, payloads chosen for the Team X study might differ from the ideal payloads envisioned by the MOSAIC science team. These differences are due to availability of necessary information for entrance into Team X as well as the fact that the MOSAIC study team continued to refine the notional payloads after the point design study. It is noted in the text where these differences arise. The payloads described in this section and the Team X documents are intended as a roadmap to MOSAIC science, where other reasonable alternatives exist or are in development.

The Team X point design for MOSAIC includes 49 instruments (22 unique) to meet the measurement requirements described in Section 1.4 MOSAIC Science Traceability. The distribution of these payloads among the different platforms is highlighted in FO3-1.

All instruments in the MOSAIC payload are described in Table 3-1, along with their distribution among the different platforms; descriptions of instruments that are already demonstrated at TRL 9 in the Mars environment are available elsewhere (Appendix B, and references therein) and so are not described here. For specific payloads where the Science Team expressed a preference for a payload or payloads that differ from what was chosen for the Team X point design, these are also described here and in Appendix B.

P-Band Synthetic Aperture Radar/Sounder

One of the outcomes of the Team X study was the ability to combine PSAR with P-Band Radar Sounder (Sounder) measurement techniques into a single instrument. The PSAR/Sounder hybrid (Table 3-1 COL 1) combines the two measurement techniques, sharing a 6-m deployable antenna for the 400 MHz measurements. PSAR/Sounder is based on previous JPL SAR designs (e.g., Campbell, B. A., et al, 2017), with additional electronics that enable the sounder mode (Section 4.2 and

Appendix D.4). This instrument has similarities to both ESA's Biomass instrument (expected launch early 2020s) and NASA's SHARAD.

There are two operational modes: PSAR pointed at 35° and Sounder pointing nadir, with spacecraft slews controlling which mode is active. The SAR images and radargrams are processed onboard, resulting in compressed data rates of 250 kbps (from 219 Mbps raw PSAR data) and 2.3 Mbps (from 175.3 Mbps raw Sounder data). Measured reflections are correlated to surface and subsurface features and inform on the presence, depth, composition, and purity of ice.

Wide Angle Imager

In order to build up pole-to-pole swaths during dayside operations, a heritage copy of MRO's MARCI (MARCI, Table 3-1 COL 2) was included in the Team X point design; this instrument is already at TRL 9 in the relevant environment. However, the MAVRIC, (Section 4.2 and Appendix B) is a TRL 5 wide angle imager with ultraviolet/visible (UV-Vis) and NIR capabilities, which would enable data collection at more wavelengths beneficial to achieving MOSAIC's objectives. In MAVRIC, UV-Vis imaging is supported by a Complementary Metal-Oxide Semiconductor (CMOS) detector and six filters spanning 340–750 nm; NIR imaging is achieved by an Indium Gallium Arsenide (InGaAs) array with another six filters covering 1.1–1.6 μm . and the complete instrument is supported by a data processing unit (DPU). MAVRIC derives heritage from MRO's MARCI, making MARCI the chosen instrument analog in the Team X point design.

MARLI for Atmospheric Studies

The MARLI for Atmospheric Studies (MARLI, Table 3-1 COL 4) is a direct-detection Doppler wind LiDAR being developed at NASA Goddard Space Flight Center (GSFC) (Cremons et al. 2020), and is expected to exit NASA's Maturation of Instruments for Solar System Exploration (MatISSE) program at TRL 6. Based on MRO's Compact Reconnaissance Imaging Spectrometer for Mars (CRISM), it consists of a 50-cm telescope and a 1064-nm laser pulsed at 250 Hz. The backscattered laser light returns through a Fabry-Perot etalon in order to discriminate the atmospheric dust and water ice aerosols by the Doppler-shifted light. A tilt table is included in the MOSAIC design to allow for

retrieval of the full wind vector (for more information, see Section 4.2 and Appendix B).

NIR Spectrometer

A compact NIR spectrometer, known as the Argus NIR Spectrometer (Table 3-1 COL 5), measures surface pressure from low Mars and areostationary orbits. Argus 2000 covers a spectral range similar to that needed for MOSAIC (1000–2200 nm versus 1000–2400 nm) and is commercially available from Thoth Technologies (Canada). It derives its heritage from Argus 1000 (Jagpal et al. 2010), which flew on the CanX-2 mission in 2008. The Argus 2000 is an extended version of the Argus 1000, covering the NIR spectrum from 1000–2200 nm with 6-nm resolution. It is a flight-ready, TRL 6 point spectrometer with integrated optics coupled to an actively-cooled InGaAs detector array. For the Team X point design, the TRL 9 Argus 1000 technical specifications were used (mass, power, dimensions); the newer Argus 2000 or the Science Team-envisioned customized spectral coverage each require minimal instrument modifications, and these minor differences in the physical parameters will not impact the point design.

Sub-mm Sounder

A TRL 5 sub-mm sounder from JPL is included connect lower and upper atmosphere winds. This passive sub-mm sounder derives heritage from the Aura Microwave Limb Sounder (Waters et al. 2006) and builds on the high heritage of the technique in Earth science applications. It uses two orthogonally-oriented steerable elliptical receivers to scan 12–32° below horizontal at 450 GHz, 3 GHz bandwidth, and 300 kHz resolution (See Appendix B and Section 4.2). The receiver front-end is coupled to a digital spectrometer through an intermediate frequency processor. This instrument operates continuously to retrieve wind speed, water vapor (including deuterated water vapor (HDO)), and temperature profiles from ~10–80 km altitude.

Wind Doppler Interferometer

The Wind Doppler Interferometer (Table 3-1 COL 6) leverages success of several Earth missions, such as NASA's Upper Atmosphere Research Satellite (UARS), which carried two such instruments (Shepherd et al. 2012, Hays et al. 1993). MOSAIC's limb-mounted Wind Doppler Interferometer is based on the MIGHTI instrument (Englert et al 2018) developed by U.S.

Naval Research Laboratory (NRL) for the Ionospheric Connection (ICON) mission (launched October, 2019). This payload uses a Doppler Asymmetric Spatial Heterodyne (DASH) technique that eliminates the need moving parts in the interferometer. It consists of two identical units that each make daytime measurements of the line-of-sight Doppler shifts of 557.7-nm and 1.27- μ m Mars airglow. The two units are pointed at 45° and 135° to spacecraft ram (FO 3-1, Mothership), and enable daytime measurements of both horizontal wind components to be measured over all altitudes (60-150 km) simultaneously.

FUV/MUV Spectrograph

The limb-mounted FUV/MUV spectrograph (Table 3-1 COL 7) derives heritage from the IUVS for the MAVEN mission, with only minor modifications including the removal of the echelle channel and a reduction of the field of view (FOV) for limb viewing only (McClintock, et al. 2015). This simplified unit is limb-mounted and requires sufficient attitude control to maintain limb pointing. IUVS measures FUV from 110-190 nm with 0.6-nm resolution and MUV from 180–340 nm with 1.2-nm resolution using a modified Czerny-Turner Design. A plane mirror is used to select from the two FOVs and a stepper motor controls whether incoming radiation is exposed to a normal-incidence grating (110-340 nm) or the high-resolution prism-echelle grating (120–131 nm). The grating, a mirror, and quartz-area division beam splitter disperse, focus, and split the incident light, sending FUV/MUV to their respective detectors (cesium iodide and cesium telluride photocathodes coupled to complementary metal-oxide-semiconductor arrays). The preferred instrument design includes minor modifications, including improving the existing baffling and removing the echelle. See Appendix B for more information about the instrument and Section 4.2 for development plan. UV instruments require stringent contamination control, and so drive the necessary contamination control plan.

Radio Occultation Experiment

A radio occultation experiment enables the measurement of electron densities from spacecraft-to-spacecraft during occultation events. This experiment utilizes a transponder, such as Iris from Mars Cube One (MarCO),

telecom-based components for X- and UHF bands (e.g., antenna, amplifiers) and USOs on each spacecraft participating in the measurements (Table 3-1 COL 9). While these components are shown in Table 3-1 for completeness, these are not bookkept as instrument payloads or as a unique instrument. While direct link from one spacecraft to Deep Space Network (DSN) have been common in planetary missions, spacecraft-to-spacecraft links offer benefits that the Earth-science community has already demonstrated. The USOs with the required Allan deviation are currently TRL 5 (see Section 4.2). Because the technologies used to perform these measurements overlap with technologies used in the telecom systems, these payloads were accounted for as a discrete instrument payload with additional mass and power needs only on the Polar platform. In the point design, the Polar, Elliptical, and Mothership platforms all participate in these radio occultation experiments. It was assumed that these platforms utilize the telecom systems for these measurements; any foreseeable mass and power differences from adding dedicated hardware (such as USOs) are small and will not change the point design.

Ion and Electron spectrometer

Already optimized for a spinning spacecraft, these two instruments are based on the THEMIS ESA design. The electron spectrometer is a heritage copy (Table 3-1 COL 10), but the ion spectrometer (Table 3-1 COL 11) is interfaced to a time-of-flight mass spectrometer based on MAVEN's SupraThermal And Thermal Ion Composition (STATIC) instrument. The components are TRL 9, but some straight-forward development is needed to interface them successfully (Section 4.2 and Appendix B).

FO 3-1. Spacecraft platforms.

SPACECRAFT SPECIFICATIONS ***

+ Refer to Foldout 3-2 for full instrument list.
++ Only Areo Smallsat Platform "B" shown. Refer to Foldout 3-2 for Areo Smallsat Platform "A" and full instrument list.
+++ Colored icons show relative size scale.

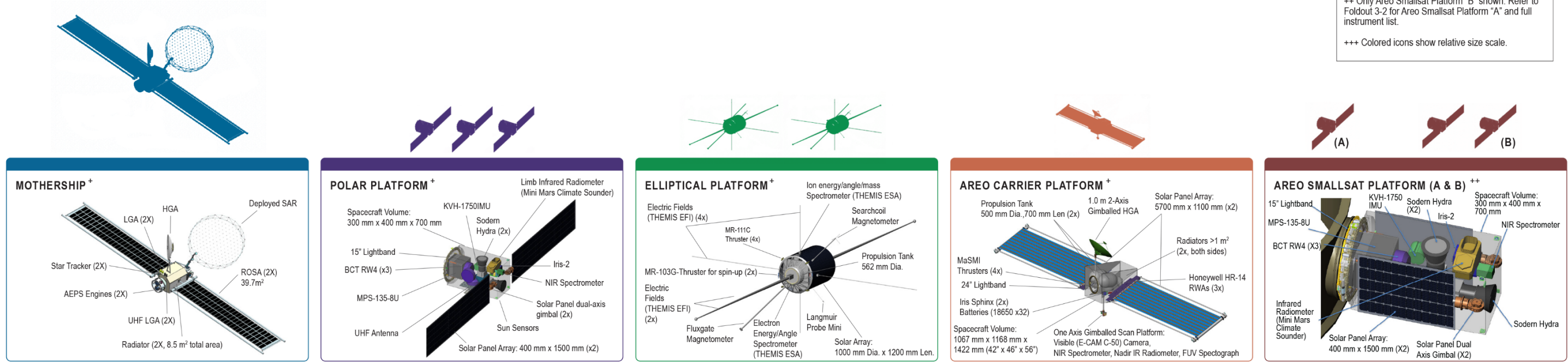

Platform Name	No. of Spacecraft Elements	No. of Science Instruments	Payload Mass (CBE)	Spacecraft Dry Mass (MEV)	Prop Mass	Spacecraft Wet Mass (MEV)	Hosted Mass	Propulsion (ΔV)	Orbit	Power (BOL @ 1 AU)	Risk Class	Data Volume (Gbits)
Mothership	1	8	240 kg	2150 kg (43%)	1550 kg	3700 kg	900 kg	SEP-2 x AEPS (7.5 km/s)	300 km x 92.8° (3 p.m. SS)	26 kW	B	158.3
Polar	3	6	4.2 kg	83 kg (43%)	9 kg	92 kg (1) 275 kg (3)	-	Green Monoprop (225 m/s)	300 km x 92.8° (spaced in LST)	~300 W	D	1.4
Elliptical	2	12	20 kg	171 kg (43%)	65 kg	235 kg (1) 470 kg (2)	-	Monoprop (500 m/s)	1500 x 6000 km x 75°	~160 W	D	0.5
Areostationary Carrier	1	9	34 kg	515 kg (43%)	285 kg	800 kg	200 kg	SEP-3 x MaSMi (5 km/s)	17031 km x 0°	3.4 kW	D	16.2
Areostationary Smallsat A	1	8	10.6 kg	87 kg (43%)	5 kg	92 kg (1)	-	Green Monoprop (50 m/s)	17031 km x 0°	~300 W	D	12.8
Areostationary Smallsat B	2	3	4.2 kg	83 kg (43%)	2 kg	92 kg (1) 184 kg (2)	-	Green Monoprop (50 m/s)	17031 km x 0°	~300 W	D	0.3

Table 3-1. Instrument list. Also referred to as FO 3-2.

Item	1	2	3	4	5	6	7	8	9	10	11	12	13	14	15	16	17	18	19	20	21	22	Units	
	P-Band SAR/Sounder	Wide Angle Imager (MARCI)	Thermal IR radiometer (AMCS)	Mars LIDAR for Atmospheric Studies (MARLI)	Sub-mm Sounder	Argus Near IR Spectrometer	Wind Doppler Interferometer	FUV/MUV Spectrograph	Radio Science Experiment	Electron Spectrometer (ESA)	Ion Spectrometer (ESA/STATIC)	Search Coil Magnetometer	Electric Fields (THEMIS EFI)	Langmuir Probe Mini (mNLP)	Fluxgate Magnetometer	Visible Camera (ECAM-C50)	Electron Energy/Angle Spectrometer (SWEA)	Ion Energy/Angle Spectrometer (SWIA)	Energetic Particle Detector	Extreme Ultraviolet Monitor	EUV/FUV Spectrograph	Thermal IR Radiometer (Mini Mars Climate Sounder, mini-MCS)		
Platform(s)	Mothership	Mothership	Mothership	Mothership	Mothership	Mothership, Polar, Areo Carrier, Areo SmallSats A & B	Mothership	Mothership	Polar, Mothership, and Elliptical (accounted in telecom system)	Elliptical	Elliptical	Elliptical	Elliptical	Elliptical	Elliptical	Elliptical, Areo Carrier, and Areo SmallSat A	Areo Carrier, Areo SmallSats A and B	Areo Carrier and Areo SmallSat A	Areo Carrier and Areo SmallSat A	Areo Carrier and Areo SmallSat A	Areo Carrier and Areo SmallSat A	Areo Carrier	Polar, Areo Carrier, Areo SmallSats A and B	
Type of instrument	Hybrid SAR/Sounder Radar	Wide-Angle Camera	Optical	LIDAR	Passive Radar	Optical	Doppler interferometer	Optical	RF	EM	EM/Mass Spectrometer	EM	EM	EM	EM	Optical	EM	EM	Particle detector	Optical	Optical	Optical	units	
Number of channels	5	7	9	1	1	100	N/A	2	N/A	N/A	N/A	N/A	N/A	N/A	N/A	3	N/A	N/A	N/A	3	1	9		
Size/dimensions (each instrument)	6-m antenna	0.92 x 0.72 x 0.14	Swept volume, 0.42 dia x 0.4	0.64 x 0.64 x 0.64	2-antenna: 0.2 x 0.2 x 0.1; 2, 0.3 diam. antennas	0.045 x 0.050 x 0.080	0.66 x 0.30 x 0.51	Instrument: 0.617 x 0.541 x 0.231; Data Processing Unit: 0.23 x 0.32 x 0.099	0.1 x 0.1 x 0.1	0.2 x 0.16 x 0.16	0.2 x 0.16 x 0.16	3 orthogonal 18-cm long rods on 1-m boom	0.08 dia spheres mounted on 6 booms	< 0.1 x 0.1 x 0.1	sensor: 0.01 x 0.01 x 0.1; electronics: 0.08 x 0.08 x 0.01	0.048 x 0.078 x 0.13	0.2 x 0.16 x 0.16	0.26 x 0.14 x 0.14	~0.08 x 0.08 x 0.08	~0.15 x 0.15 x 0.15	~0.3 x 0.6 x 0.6	0.1 x 0.1 x 0.2	m x m x m	
Instrument mass without contingency (CBE*)	90.9	1	9	45	26.9	0.23	40	27	3	1.6	2.6	1.8	12	0.3	1.3 (2 sensors with boom)	0.5	1.8	2.8	0.9	1.1	21	3.5	kg	
Instrument mass % contingency	30	15	30	30	30	30	30	30	30	30	30	30	30	30	30	30	30	30	30	30	30	30	%	
Instrument mass with contingency (CBE+ Reserve)	118.17	1.15	11.7	58.5	35	0.3	52	35.1	3.9	2.08	3.64	2.34	15.6	0.39	1.69	0.65	2.34	3.64	1.17	1.43	27.3	4.55	kg	
Instrument avg payload power without contingency	110	4.6	18	91	39	2.5	20	28	5	1	3.7	0.08	0.24	1	4.9	2.5	1.6	3.7	5.5	0.73	12	8	W	
Instrument avg payload power % contingency	30	15	30	30	30	30	30	30	30	30	30	30	30	30	30	30	30	30	30	30	30	30	%	
Instrument avg payload power with contingency	143	5.29	23.4	118.3	50.7	3.25	26	36.4	6.5	1.3	4.81	0.104	0.312	1.3	6.37	3.25	2.08	4.81	7.15	0.949	15.6	10.4	W	
Instrument avg science data rate* without contingency	2700	515	4	50	10	17.5	14	0.013	20	1	1	~1	1	0.01	0.8	294000	1	1	0.8	0.2	20	4	kbps	
Instrument FOV (if appropriate)	4.8	180 (crosstrack) x 26 (downtrack)	4	0.034	0.1	0.12	3 x 5	2 x 0.06 (instantaneous)	-	180° x 6° (4 pi sweep)	180° x 6° (4 pi sweep)	Omnidirectional	Omnidirectional	Omnidirectional	Omnidirectional	29 x 22	360 x 120	360 x 90	42° x 31°	6	0.7 x 11 slit	4	degrees	
Pointing reqs (knowledge)	0.2	0.1	0.04	0.17	0.043	-	0.05	0.06	Fixed pointing through occultations	not driving	Spun	None	Spun at ~15 rpm	None	Spun	1	mounted on solar	not driving	not driving	mounted on solar array	not driving	0.085	degrees	
Pointing reqs (control)	0.5	-	0.086	0.17	0.086	0.15	0.1	0.3	Fixed pointing through occultations	not driving	Spun	None	Spun at ~15 rpm	None	Spun	not driving	mounted on solar	not driving	not driving	mounted on solar array	not driving	0.046	degrees	
Pointing reqs (stability)	0.5	-	0.02	0.17	0.02	-	0.002	0.001	Fixed pointing through occultations	not driving	Spun	None	Spun at ~15 rpm	None	Spun	not driving	mounted on solar	not driving	not driving	mounted on solar array	not driving	0.023 over 2 sec; 0.0029 over 16 sec	deg/sec	

*CBE = Current Best Estimate.

*Instrument data rate defined as science data rate prior to on-board processing

**contingencies on data rate were not applied to individual instruments; instead, contingency was built into the concept of operations (Section 3.3)

◆The characteristics shown here estimated for a dedicated USO and transponder. Team X point design leveraged the telecommunications systems rather than book-keeping this as a "payload," however, this was included here for completeness.

Mini Langmuir Probe

Traditional Langmuir probes' voltage sweeping are inappropriate for small spacecraft because they swing the spacecraft potential wildly, disturbing low-energy ion and electron measurements. For MOSAIC, we leverage the lessons from PI Lillis' Escape and Plasma Acceleration and Dynamics Explorers (EscaPADE) plasma smallsat development and use Langmuir probe sensors which are lightweight, low-power, and fixed-bias, i.e. they do not disturb other measurements. The point design from Team X uses single copy of the multi-Needle Langmuir probe (mNLP) sensor (Table 3-1 COL 13), but a version of the instrument that combines a mNLP, a floating potential probe, and two planar ion probes is preferred for achieving MOSAIC's objectives (Appendix B.1.4). The mass and power differences between the preferred instrument and mNLP are small (0.5 versus 0.3 kg, and 1.5 W versus 1 W) and so will not change the point design described.

Visible Camera

The Chameleon Imager derives heritage from the SCS Aerospace Group Gecko Imager onboard the nSight-1 satellite. This commercially-available camera is capable of observing both in panchromatic mode as well as in eight channels covering the visible/NIR spectrum. For the Team X study, the similar ECAM-C50 (Table 3-1 COL 17) from Malin Space Systems was used in the point designs described, with the main difference being that the Chameleon imager needs to be scanned to achieve MOSAIC objectives while ECAM-C50 does not.

Thermal Infrared Radiometer

NASA JPL has developed a smaller version of MRO's mini-MCS, Table 3-1 COL 23) that fits within ~2 U, allowing for spacecraft actuators and necessary systems, with a current TRL 6. Like MRO-MCS, this filter-based radiometer observes atmospheric emission from nadir and limb views of the atmosphere, which are calibrated against views of outer space in nine broadband channels. In this design, each channel consists of a linear array of uncooled thermopile detectors that instantaneously measures a radiance profile when vertically pointed at the limb. The key difference from MCS is a minor modification to one channel, making it insensitive to water vapor (Kleinböhl et al. 2018). There are two unique versions of Mini-MCS included in MOSAIC on

the Polar and Areo Carrier platforms. The differences a small (e.g., channel selection, detector geometry) and because this does not result in major differences between the two, they are discussed here are one instrument type, with the performance dictated by the science of the platform on which they are included.

Extreme Ultraviolet Monitor (EUVM)

The EUVM consists of four silicon photodiodes. Three are integrated with filters covering different bandpasses: 0.1–7, 17–22, and 121–122 nm. The fourth photodiode monitors dark signal and the resulting signal changes due to temperature and radiation. Currently at TRL 4, EUVM derives heritage from MAVEN's EUVM, which was used in the Team X point design (EUVM, Table 3-1 COL 20), but with a smaller overall footprint and an optical path that improves sensitivity (For more information, see Section 4.2 and Appendix D). EUVM is always on and collects a measurement every second from an areostationary orbit.

These instruments are supported by six different platforms (FO-3-1) placed in three different orbits (FO 2-1) to function, in concert, to deliver on the MOSAIC's objectives (Section 1.3). Projected mass and powers are shown in Table 3-2. Thirty percent contingency is used on all payloads per JPL best practices. Contingency on data rate was not applied individually by instrument. With the exception of the Areo Carrier and Areo SmallSat A/B platforms, data will be relayed via the mothership and includes margin. For the Areo Carrier and Areo SmallSat A/B platforms, the contingency was built into the concept of operations (Section 3.3), also with margin. More information on data can be found in Appendix B.

Table 3-2. Payload Mass and Power.

Payload	Platform	Mass			Average Power		
		CBE (kg)	% Cont.	MEV (kg)	CBE (W)	% Cont.	MEV (W)
P-Band SAR/Sounder	Mothership	90.9	30	118.17	110	30	143
Wide Angle Imager (MARCI)	Mothership	1	15	1.15	4.6	15	5.29
Thermal IR radiometer (AMCS)	Mothership	9	30	11.7	18	30	23.4
Mars LiDAR for Atmospheric Studies (MARLI)	Mothership	45	30	58.5	91	30	118.3
Sub-mm Sounder	Mothership	26.9	30	35	39	30	50.7
Argus Near IR Spectrometer	Mothership, Polar, Areo Carrier, Areo SmallSats A & B	0.23	30	0.3	2.5	30	3.25
Wind Doppler interferometer	Mothership	40	30	52	20	30	26
FUV/MUV Spectrograph	Mothership	27	30	35.1	28	30	36.4
Radio Science Experiment	Polar, Mothership, and Elliptical (accounted in telecom system)	3	30	3.9	5	30	6.5
Electron spectrometer (ESA)	Elliptical	1.6	30	2.08	1	30	1.3
Ion Spectrometer (ESA/STATIC)	Elliptical	2.8	30	3.64	3.7	30	4.81
Search Coil Magnetometer	Elliptical	1.8	30	2.34	0.08	30	0.104
Electric Fields (THEMIS EFI)	Elliptical	12	30	15.6	0.24	30	0.312
Langmuir Probe Mini (mNLP)	Elliptical	0.3	30	0.39	1	30	1.3
Fluxgate magnetometer	Elliptical, Areo Carrier, and Areo SmallSat A	1.3 (2 sensors with boom)	30	1.69	4.9	30	6.37
Visible Camera (ECAM-C50)	Areo Carrier, Areo SmallSats A and B	0.5	30	0.65	2.5	30	3.25
Electron energy/angle spectrometer (SWEA)	Areo Carrier and Areo SmallSat A	1.8	30	2.34	1.6	30	2.08
Ion Energy/Angle Spectrometer (SWIA)	Areo Carrier and Areo SmallSat A	2.6	30	3.38	3.7	30	4.81
Energetic Particle Detector	Areo Carrier and Areo SmallSat A	0.9	30	1.17	5.5	30	7.15
Extreme Ultraviolet Monitor	Areo Carrier and Areo SmallSat A	1.1	30	1.43	0.73	30	0.949
EUV/FUV Spectrograph	Areo Carrier	21	30	27.3	12	30	15.6
Thermal Infrared Radiometer (Mini Mars Climate Sounder, mini-MCS)	Polar, Areo Carrier, Areo SmallSats A and B	3.5	30	4.55	8	30	10.4
Total Payload Mass (Mothership)		240.0		311.92			
Total Payload Mass (Polar)		4.23		5.5			
Total Payload Mass (Elliptical)		19.8		25.74			
Total Payload Mass (Areo Carrier)		34.2*		42.81			
Total Payload Mass (AreoSmallSat A)		10.63		15.51			
Total Payload Mass (Areo SmallSat B)		4.23		5.5			

*Additional mass was included in the design for scan mirrors needed for instrument pointing.

3.2 Flight System

Baseline Constellation Launch and Cruise Flight Element Configurations

The Baseline Constellation consists of ten orbiters: a single large mothership and nine smaller spacecraft orbiters. These ten spacecraft are classified into six different platforms:

Mothership, Elliptical, Polar, Areo Carrier, and Areo SmallSats A and B (FO 3-1). All ten spacecraft elements are launched on a single Falcon Heavy Recoverable launch vehicle or equivalent. The large Mothership is placed atop two ESPA rings and carries three Polar smallsats and two Elliptical smallsats; one ESPA ring is permanently attached to the large mothership

orbiter (FO 2-1). Attached to the other ESPA ring is the Areo Carrier which accommodates three areo smallsats (one copy of Areo Smallsat A, and two copies of Areo Smallsat B), see FO 2-1. After launch, the Mothership/Polar/Elliptical group separates from the Areo Carrier/Areo SmallSats A and B group, sending two groups of platforms to Mars orbit (FO 2-1). For overviews of the different MOSAIC platforms (FO 3-1).

MOSAIC Platforms

Mothership Platform Flight System

The MOSAIC Mothership platform spacecraft (FO 3-1) is a solar electric powered bus with 7500 m/s of ΔV propulsive capability. The expected design life for the Class B fully redundant spacecraft is 72 months (Table 3-4).

The Mothership carries eight science instruments; a P-band SAR/sounder radar, a wide angle camera, a limb radiometer, a LiDAR, a sub-mm sounder, a wind interferometer, and an FUV/MUV spectrograph (Table 3-2). The SAR/sounder has a 6-meter deployable mesh antenna on an unfolding boom. A 2-axis gimbal allows the antenna and feed to both scan off-track at 30° for SAR mode and a nadir facing orientation for radar sounding mode (see Appendix D for more description). The wind LiDAR instrument has a 50 cm optical telescope fixed to the spacecraft pointed 30° off-nadir. The remaining instruments are body fixed to the nadir deck of the spacecraft (FO-3-1). The mothership is capable of taking simultaneous nadir and limb science measurements and has a pointing error and knowledge capability of 0.01 degrees.

Solar power comes from two flexible 40 square meter roll out solar arrays (ROSA) capable of generating 24 kilowatts at beginning of life, with an estimated end-of-life rating of 13 kilowatts. The solar arrays are each on single-axis gimbals to allow for the arrays to articulate and generate electricity at Mars during science and telecommunication operations. The SEP system requires 100V to drive the SEP power PPU, the rest of the spacecraft operates at a nominal 32 V. The power electronics have commonality to Europa clipper orbiter. Table 3-3 breaks down the elements of the flight system by mass a power.

Table 3-3. Mothership Flight System Element Mass and Power.

	Mass			Average Power		
	CBE (kg)	% Cont.	MEV (kg)	CBE (W)	% Cont.	MEV (W)
Structures & Mechanisms	555	30%	721	n/a	n/a	n/a
Thermal Control	50	30%	65	967	30%	1257
Propulsion (Dry Mass)	274	15%	316	11300	30%	14690
Attitude Control	67	10%	73	109	30%	142
C&DH	29	17%	34	69	30%	90
Telecommunications	70	14%	80	454	30%	590
Power	234	29%	301	260	30%	338
Total Flight Element Dry Bus Mass	1279	24%	1590			

The telecommunication system requires UHF, X-Band, and Ka-band frequency capability to support science operations and act as a relay for the Polar and Elliptical smallsats. The mothership telecommunication system is a fully redundant design. The telecommunication hardware includes a single 3 m X/Ka-band HGA, two X-band low gain antennas, and two UHF low gain helix antennas. Two UHF/X/Ka-band UST are specified powered by two 200 watt, (377 W DC consumption), Ka-band Traveling Wave Tube Amplifiers (TWTA) and dual 25 watt X-band TWTAs, see Figure 3-1.

A smaller mothership variant, called Mini-Mothership, was also examined (Table 3-2) descopes half of the science payload to a total of four instruments (MARCI, AMCS, Argus NIR Spectrometer, and FUV/MUV; Table 3-2, COL 2, 3, 6, and 8), targeting fewer of MOSAIC objectives. Both Mothership and Mini-Mothership can carry the two Elliptical and three Polar smallsats to Mars (Appendix B, Table B-1). Table 3-4 shows the flight system characteristics of both Mothership designs, highlighting where the two differ. Details of mass and power for the Mini-mothership are found in Table 3-5 and in Appendix B.

Table 3-4. MOSAIC Mothership Platform Flight System Element Characteristics.

Flight System Element Parameters (as appropriate)	Mothership Value/Summary, units	Mini-Mothership Value/Summary, units
General		
Design Life, months	57–80*	57–80*
Structure		
Structures material (aluminum, exotic, composite, etc.)	Aluminum	Aluminum
Number of articulated structures	3	3
Number of deployed structures	3	3
Aeroshell diameter, m	n/a	n/a
Thermal Control		
Type of thermal control used	Passive	Passive
Propulsion		
Estimated delta-V budget, m/s	7500	7500
Propulsion type(s) and associated propellant(s)/oxidizer(s)	Solar Electric Propulsion, Xenon Propellant	Solar Electric Propulsion, Xenon Propellant
Number of thrusters and tanks	2 AEPS Thrusters; 1 Xenon Tank	2 AEPS Thrusters; 1 Xenon Tank
Specific impulse (Isp) of each propulsion mode, seconds	Varies during traj: 2400 - 2800	Varies during traj: 2400 - 2800
Attitude Control		
Control method (3-axis, spinner, grav-gradient, etc.)	3-axis	
Control reference (solar, inertial, Earth-nadir, Earth-limb, etc.)	Star tracker augmented by Inertial Measurement Unit (IMU)	Star tracker augmented by IMU
Attitude control capability, degrees	0.01	0.01
Attitude knowledge limit, degrees	0.05	0.05
Agility requirements (maneuvers, scanning, etc.)	SAR/Sounder Scan Off-track, Simultaneous Limb and Nadir pointed instrument with their own mechanisms.	Simultaneous Limb and Nadir pointed instrument with their own mechanisms.
Articulation/#-axes (solar arrays, antennas, gimbals, etc.)	Each roll out solar array deploys and articulates on a 1-axis gimbal. The HGA is on a single deployable boom and articulates on a 2-axis gimbal.	Each roll out solar array deploys and articulates on a 1-axis gimbal. The HGA is on a single deployable boom and articulates on a 2-axis gimbal.
Sensor and actuator information (precision/errors, torque, momentum storage capabilities, etc.)	Reaction Torque: 0.1 - 0.2 N-m; Momentum storage: 100 N-m-s;	Reaction Torque: 0.1 - 0.2 N-m; Momentum storage: 50 N-m-s;
Command & Data Handling		
Flight Element housekeeping data rate, kbps	140	55
Data storage capacity, Mbits	1024000	1024000
Power		
Type of array structure (rigid, flexible, body mounted, deployed, articulated)	ROSA Solar Arrays; Flexible, deployed, and articulated	ROSA Solar Arrays; Flexible, deployed, and articulated
Array size, meters x meters	79.2m ² total area; 39.6m ² per panel; 2 panels per spacecraft	53m ² total area; 26.5m ² per panel; 2 panels per spacecraft
Solar cell type (Si, Gallium Arsenides (GaAs), Multi-junction GaAs, concentrators)	Multi-junction GaAs	Multi-junction GaAs
Expected power generation at Beginning of Life (BOL) and End of Life (EOL), watts	BOL: 24178; EOL: 13081	BOL: 16171; EOL: 8749
On-orbit average power consumption, watts	1016	1016
Battery type (NiCd, NiH, Li-ion)	Li-ion	Li-ion
Battery storage capacity, amp-hours	120	80

*The baseline mission science is two Mars years. In the Team X studies, some analysis, and the lifecycle mission cost one Mars year is assumed. There are no mothership platform impacts of this difference between two and one Mars years of baseline science.

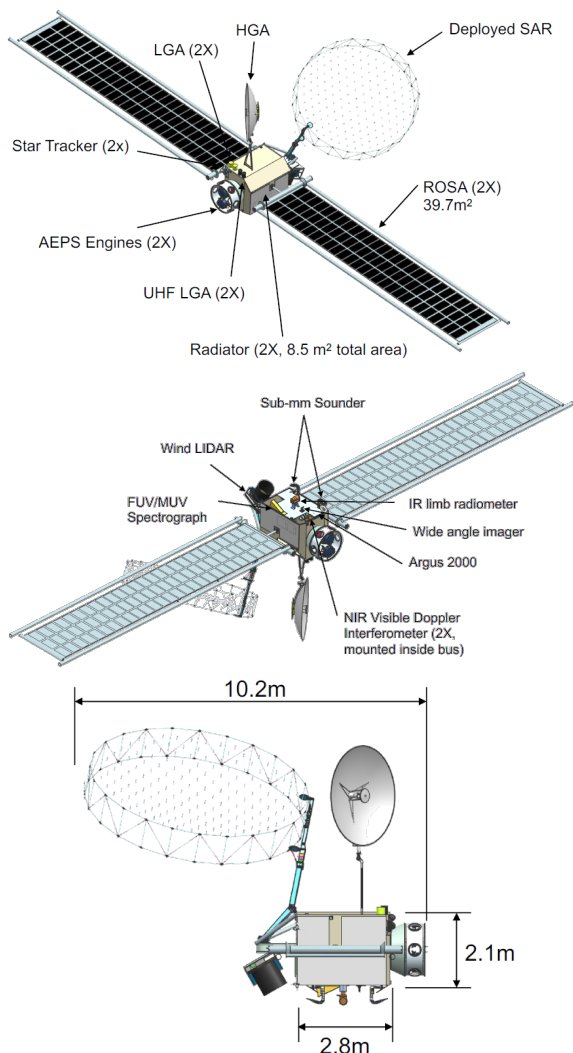

Figure 3-1. Mothership Flight System Configuration.

Table 3-5. Mini-Mothership Flight System Element Mass and Power.

	Mass			Average Power		
	CBE (kg)	% Cont.	MEV (kg)	CBE (W)	% Cont.	MEV (W)
Structures & Mechanisms	386	30%	502	n/a	n/a	n/a
Thermal Control	42	30%	54	515	30%	670
Propulsion (Dry Mass)	249	13%	283	7338	30%	9539
Attitude Control	55	10%	60	109	30%	142
C&DH	25	17%	30	63	30%	82
Telecommunications	59	14%	67	454	30%	590
Power	169	28%	216	196	30%	255
Total Flight Element Dry Bus Mass	984	23%	1211			

Polar Platform Flight System

The 3-axis stabilized Polar smallsat flight systems are Class D, single string and carried to low Mars orbit by the Mothership. They have minimal propulsion to enable small changes to the orbit that result in drift of the orbit plane. Three identical Polar smallsats end up at different local solar times with three hour separation. The Polar smallsat design accommodates all of the various orbit conditions for power and data return via relay to the Mothership. Each spacecraft has three instruments that require pointing: the Thermal Infrared Radiometer (limb-pointed), the NIR Spectrometer (nadir-pointed), and the Radio Occultation Experiment, with X-band and UHF frequencies pointed to other spacecraft (Table 3-1 COL 6, 22, and 9, respectively). The spacecraft configuration allows all three to be satisfied, though not necessarily simultaneously. The Thermal Infrared Radiometer is located on the ram face of the spacecraft and cannot point at the sun. No specific limb direction constraints were assumed. The NIR Spectrometer is located on the nadir deck and faces nadir at all times. The UHF and X-band antennas are on the anti-ram deck. The solar arrays are on two-axis gimbals this allows them to stay sun-pointed for all three required local times (12, 6, 9) with a single design (9 a.m./9 p.m. is most stressing case). See FO 3-1, Polar for mounting configuration. Table 3-6 breaks down the flight system elements by mass and power Table 3-7 shows the flight system element characteristics. FO 3-1 shows the location of the different subsystem elements.

Table 3-6. Polar Platform Flight System Element Mass and Power.

	Mass			Average Power		
	CBE (kg)	% Cont.	MEV (kg)	CBE (W)	% Cont.	MEV (W)
Structures & Mechanisms	28.9	24%	35.8	0.0	n/a	n/a
Thermal Control	1.8	30%	2.3	15.4	30%	20.0
Propulsion (Dry Mass)	5.1	20%	6.1	35.0	30%	45.5
Attitude Control	11.4	10%	12.6	26.8	30%	34.8
C&DH	0.4	19%	0.4	4.0	30%	5.2
Telecommunications	2.9	13%	3.3	35.0	30%	45
Power	3.3	15%	3.7	7.5	30%	9.7
Total Flight Element Dry Bus Mass	53.7	20%	64.3			

Table 3-7. MOSAIC Polar Platform Flight System Element Characteristics.

Flight System Element Parameters (as appropriate)	Value/Summary, units
General	
Design Life, months	36
Structure	
Structures material (aluminum, exotic, composite, etc.)	Aluminum
Number of articulated structures	2
Number of deployed structures	2
Aeroshell diameter, m	n/a
Thermal Control	
Type of thermal control used	Passive
Propulsion	
Estimated delta-V budget, m/s	200
Propulsion type(s) and associated propellant(s)/oxidizer(s)	Chemical Propulsion: AF-M315E "Green Propellant"
Number of thrusters and tanks	1 Modular Propulsion System; built-in tank
Specific impulse of each propulsion mode, seconds	266
Attitude Control	
Control method (3-axis, spinner, grav-gradient, etc.)	3-axis
Control reference (solar, inertial, Earth-nadir, Earth-limb, etc.)	Star tracker augmented by IMU
Attitude control capability, degrees	0.4
Attitude knowledge limit, degrees	0.05
Agility requirements (maneuvers, scanning, etc.)	Nadir facing
Articulation/#-axes (solar arrays, antennas, gimbals, etc.)	(2) Solar panels deploy rigid panels from body of spacecraft; each panel has a 2-axis gimbal
Sensor and actuator information (precision/errors, torque, momentum storage capabilities, etc.)	Reaction Torque: .25 N-m; Momentum storage: 4 N-m-s
Command & Data Handling	
Flight Element housekeeping data rate, kbps	65
Data storage capacity, Mbits	1024000
Power	
Type of array structure (rigid, flexible, body mounted, deployed, articulated)	Rigid; deployed; articulated
Array size, meters x meters	1.5 m x 0.4 m (per panel); 2 panels per spacecraft
Solar cell type (Si, GaAs, Multi-junction GaAs, concentrators)	Multi-junction GaAs
Expected power generation at Beginning of Life (BOL) and End of Life (EOL), watts	BOL: 452.1 W (Earth) BOL: 194.7 W (Mars) EOL: 167 W (Mars)
On-orbit average power consumption, watts	94
Battery type (NiCd, NiH, Li-ion)	Li-ion
Battery storage capacity, watt-hours	BOL: 140 Wh; EOL: 120 Wh

Elliptical Platform Flight System

The two identical, 15 RPM spinning cylindrical smallsat flight systems are Class D, single string

and carried to polar, elliptical Mars orbit (4-hour period, 150 km periapsis) by the Mothership. They use chemical ΔV propulsion to lower periapsis, to establish a 10–30 minutes in-orbit separation, and to maintain the elliptical orbit. The spinning Elliptical smallsat design (FO 3-1, Elliptical) accommodates the unique electric field measurements and simplifies the flight system design, while enabling data return via relay to the Mothership. Probes at the ends of four 20-m centrifugally stabilized wire booms and two oppositely directed 3.5-m stacer booms along the spin axis measure electric fields and waves in three dimensions. Two magnetometers (fluxgate and search coil) on separate booms simultaneously measure magnetic fields and waves in three dimensions, much like the THEMIS mission (Angelopoulos et al. 2009). Instruments included on the Elliptical platform include the electron and ion spectrometers, the search coil and fluxgate magnetometers, the electric fields instrument, and the Langmuir probe, as well as telecom hardware for the Radio Occultation Experiments (Table 3-1 COL 9–15).

The telecommunication system operates on UHF and X-band frequency. UHF system is similar to MarCO and uses the IRIS radio with a UHF slice to relay data to Mothership and for radio occultation. X-band is used only for radio occultation.

For more information on the trade space considered for this platform, see Appendix B. See FO 3-1, Elliptical for mounting configuration. Table 3-8 breaks down the flight system elements by mass and power. Table 3-9 shows the flight system element characteristics.

Table 3-8. Elliptical Platform Flight System Element Mass and Power.

	Mass			Average Power		
	CBE (kg)	% Cont.	MEV (kg)	CBE (W)	% Cont.	MEV (W)
Structures & Mechanisms	61.6	24%	76.6	0.0	n/a	n/a
Thermal Control	2.5	30%	3.3	2.9	30%	3.8
Propulsion (Dry Mass)	20.7	9%	22.5	50.2	30%	65.3
Attitude Control	2.4	10%	2.7	8.6	30%	11.2
C&DH	0.4	19%	0.4	4.0	30%	5.2
Telecommunications	3.9	15%	4.5	37.0	30%	48.1
Power	8.1	15%	9.4	7.5	30%	9.7
Total Flight Element Dry Bus Mass	99.7	20%	119.3			

Table 3-9. MOSAIC Elliptical Platform Flight System Element Characteristics.

Flight System Element Parameters (as appropriate)	Value/Summary, units
General	
Design Life, months	36
Structure	
Structures material (aluminum, exotic, composite, etc.)	Aluminum
Number of articulated structures	0
Number of deployed structures	6
Aeroshell diameter, m	n/a
Thermal Control	
Type of thermal control used	Passive
Propulsion	
Estimated delta-V budget, m/s	550
Propulsion type(s) and associated propellant(s)/oxidizer(s)	Chemical (Mono-prop blowdown); Hydrazine propellant
Number of thrusters and tanks	(6) Monoprop hydrazine spin up thrusters; (1) diaphragm tank (7250 in ³)
Specific impulse of each propulsion mode, seconds	229
Attitude Control	
Control method (3-axis, spinner, grav-gradient, etc.)	Spinner
Control reference (solar, inertial, Earth-nadir, Earth-limb, etc.)	Spinning sun sensor; augmented with horizon sensor and single IMU
Attitude control capability, degrees	<1
Attitude knowledge limit, degrees	<1
Agility requirements (maneuvers, scanning, etc.)	Spinning Spacecraft at 15 rpm; omnidirectional instruments
Articulation/#-axes (solar arrays, antennas, gimbals, etc.)	Deployment of sensor booms
Sensor and actuator information (precision/errors, torque, momentum storage capabilities, etc.)	6 body mounted sun sensors; 1 per body axis; Horizon sensor, 1-axis, 1 deg
Command & Data Handling	
Flight Element housekeeping data rate, kbps	11
Data storage capacity, Mbits	1024000
Power	
Type of array structure (rigid, flexible, body mounted, deployed, articulated)	Body mounted
Array size, meters x meters	1 m diameter x 1.2 m length
Solar cell type (Si, GaAs, Multi-junction GaAs, concentrators)	Multi-junction GaAs
Expected power generation at Beginning of Life (BOL) and End of Life (EOL), watts	BOL: 169.9 W (Mars) EOL: 131.3 W (Mars)
On-orbit average power consumption, watts	71
Battery type (NiCd, NiH, Li-ion)	Li-ion
Battery storage capacity, watt-hours	BOL: 282 Wh; EOL: 240 Wh

Areo Carrier Platform Flight System

As designed, the 3-axis SEP Areo Carrier is Class D, single string. However, a future study should examine benefits of upgrading to Class C

or B with some redundancy. This platform carries the three Areo SmallSats (of type A and B) into areostationary and drops them off at the correct node to establish an equatorial orbit, with 90 degree separation between each ascending node. Areo Carrier accommodates nine instruments: The magnetometer and ion energy/angle instruments are body-mounted; the electron energy/angle spectrometer, energetic ion/electron spectrometer, and extreme UV instruments are co-located on the solar arrays; the visible camera, NIR spectrometer, IR radiometer, and FUV spectrograph are placed on a 1-axis gimbaled deck to maintain pointing at the center of Mars.

See FO 3-1, Areo Carrier for mounting configuration. Table 3-10 breaks down the flight system elements by mass and power. Tables 3-11 shows the flight system element characteristics.

Table 3-10. Areo Carrier Platform Flight System Element Mass and Power.

	Mass			Average Power		
	CBE (kg)	% Cont.	MEV (kg)	CBE (W)	% Cont.	MEV (W)
Structures & Mechanisms	148.6	24%	183.9	0	n/a	n/a
Thermal Control	1.7	30%	2.2	184.42	30%	23 9.7
Propulsion (Dry Mass)	78.4	9%	85.1	1012.6	30%	1316.4
Attitude Control	31.8	10%	35.0	115.52	30%	150.2
C&DH	1.3	20%	1.6	4.75	30%	6.2
Telecommunications	24.2	15%	27.8	12.3	30%	16.0
Power	36.6	15%	42.1	38.2	30%	49.7
Total Flight Element Dry Bus Mass	322.5	17%	377.7			

Table 3-11. MOSAIC Areo Carrier Platform Flight System Element Characteristics.

Flight System Element Parameters (as appropriate)	Value/Summary, units
General	
Design Life, months	36
Structure	
Structures material (aluminum, exotic, composite, etc.)	Aluminum
Number of articulated structures	4
Number of deployed structures	4
Aeroshell diameter, m	n/a
Thermal Control	
Type of thermal control used	Passive
Propulsion	
Estimated delta-V budget, m/s	5000

Table 3-11. MOSAIC Areo Carrier Platform Flight System Element Characteristics.

Flight System Element Parameters (as appropriate)	Value/Summary, units
Propulsion type(s) and associated propellant(s)/oxidizer(s)	Solar Electric Propulsion, Xenon Propellant
Number of thrusters and tanks	(4) MaSMi Thruster Strings; (2) Xenon Tanks
Specific impulse of each propulsion mode, seconds	1800
Attitude Control	
Control method (3-axis, spinner, grav-gradient, etc.).	3-axis
Control reference (solar, inertial, Earth-nadir, Earth-limb, etc.)	Star tracker augmented by IMU
Attitude control capability, degrees	0.1
Attitude knowledge limit, degrees	0.05
Agility requirements (maneuvers, scanning, etc.)	Nadir pointed instrument with their own mechanisms.
Articulation/#-axes (solar arrays, antennas, gimbals, etc.)	Each roll out solar array deploys and articulates on a 1-axis gimbal. The HGA is on a single deployable boom and articulates on a 2-axis gimbal. One axis-gimballed scan platform.
Sensor and actuator information (precision/errors, torque, momentum storage capabilities, etc.)	Reaction Torque: 0.1 - 0.2 N-m; Momentum storage: 14 N-m-s;
Command & Data Handling	
Flight Element housekeeping data rate, kbps	290
Data storage capacity, Mbits	1024000
Ta	
Type of array structure (rigid, flexible, body mounted, deployed, articulated)	ROSA Solar Arrays; Flexible, deployed, and articulated
Array size, meters x meters	5.7 m x 1.1 m (per panel; 2 panels per spacecraft)
Solar cell type (Si, GaAs, Multi-junction GaAs, concentrators)	Multi-junction GaAs
Expected power generation at Beginning of Life (BOL) and End of Life (EOL), watts	BOL: 4547.2 W (Earth) BOL: 1958.6 W (Mars) EOL: 1681.2 W (Mars)
On-orbit average power consumption, watts	665
Battery type (NiCd, NiH, Li-ion)	Li-ion
Battery storage capacity, watt-hours	BOL: 829 Wh; EOL: 704 Wh

Areo SmallSats A/B Platforms Flight System

The 3-axis stabilized Areo SmallSats A and B flight systems are both Class D, single string, and carried to low areostationary orbit by the Areo Carrier. They have minimal propulsion to enable small changes to the orbit for station-keeping (see Table 3-13). There are two “flavors” of areo smallsats since one payload suite is ~15 kg, and

the other is ~5 kg. Areo SmallSat A carries a Near IR spectrometer, fluxgate magnetometer, visible camera, electron and ion energy/angle spectrometers, the energetic particle detector, extreme UV monitor, and thermal infrared radiometer (Table 3-1 COL 6, 15-20, and 22); Areo SmallSat B carries only a visible camera, a Near IR spectrometer, and thermal infrared radiometer (Table 3-1 COL 6, 16, and 22) Other than the payloads, these smallsats are completely modular; this flight system design also overlaps with the Polar smallsat flight system since the requirements for each is very similar.

See FO 3-1 and Figure 3-2 for Areo SmallSat A and B mounting configuration. Table 3-12 breaks down the flight system elements by mass and power Tables 3-13 shows the flight system element characteristics.

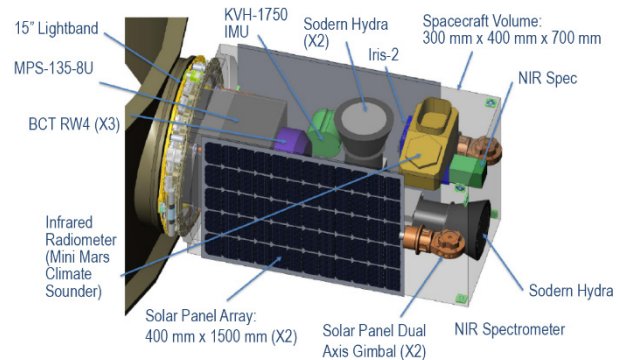

Figure 3-2. Shows Areo Smallsat A or B on the ESPA ring port with some of the flight system subsystems shown.

Table 3-12. Areo Smallsat A and B Platform Flight System Element Mass and Power.

	Mass			Average Power		
	CBE (kg)	% Cont.	MEV (kg)	CBE (W)	% Cont.	MEV (W)
Structures & Mechanisms	28.89	24%	35.8	0	n/a	n/a
Thermal Control	1.79	30%	2.32	15.37		
Propulsion (Dry Mass)	5.1	20%	6.1	0		
Attitude Control	11.41	10%	12.55	26.8		
C&DH	0.36	19%	0.43	4		
Telecommunications	2.9	13%	3.29	35		
Power	3.25	15%	3.73	7.47		
Total Flight Element Dry Bus Mass	53.69	20%	64.26	90.15		

Table 3-13. MOSAIC Areo A/B Platform Flight System Element Characteristics.

Flight System Element Parameters (as appropriate)	Value/Summary, units
General	0
Design Life, months	36
Structure	0
Structures material (aluminum, exotic, composite, etc.)	Aluminum
Number of articulated structures	2
Number of deployed structures	2
Aeroshell diameter, m	n/a
Thermal Control	0
Type of thermal control used	Passive
Propulsion	0
Estimated delta-V budget, m/s	200
Propulsion type(s) and associated propellant(s)/oxidizer(s)	Chemical Propulsion; AF-M315E "Green Propellant"
Number of thrusters and tanks	1 Modular Propulsion System; built-in tank
Specific impulse of each propulsion mode, seconds	266
Attitude Control	
Control method (3-axis, spinner, grav-gradient, etc.)	3-axis
Control reference (solar, inertial, Earth-nadir, Earth-limb, etc.)	Star tracker augmented by IMU
Attitude control capability, degrees	0.4
Attitude knowledge limit, degrees	0.05
Agility requirements (maneuvers, scanning, etc.)	Nadir facing
Articulation/#-axes (solar arrays, antennas, gimbals, etc.)	(2) Solar panels deploy rigid panels from body of spacecraft; each panel has a 2-axis gimbal
Sensor and actuator information (precision/errors, torque, momentum storage capabilities, etc.)	Reaction Torque: .25 N-m; Momentum storage: 4 N-m-s;
Command & Data Handling	
Flight Element housekeeping data rate, kbps	65
Data storage capacity, Mbits	1024000
Power	
Type of array structure (rigid, flexible, body mounted, deployed, articulated)	Rigid; deployed; articulated
Array size, meters x meters	1.5 m x 0.4 m (per panel; 2 panels per spacecraft)
Solar cell type (Si, GaAs, Multi-junction GaAs, concentrators)	Multi-junction GaAs
Expected power generation at Beginning of Life (BOL) and End of Life (EOL), watts	BOL: 452.1 W (Earth) BOL: 194.7 W (Mars) EOL: 167 W (Mars)
On-orbit average power consumption, watts	94
Battery type (NiCd, NiH, Li-ion)	Li-ion
Battery storage capacity, watt-hours	BOL: 140 Wh; EOL: 120 Wh

3.3 Concept of Operations and Mission Design

Baseline Constellation Concept of Operations

After launch and separation from the launch vehicle, all spacecraft will be put on a Mars-bound trajectory with two free flying elements. The first element is the Areo Carrier with three Areo A/B spacecraft with a final destination of Mars areostationary (17032 km) orbit. The second element is the Mothership which hosts the Polar and Elliptical spacecraft during cruise and spiral down in Mars orbit. For additional details regarding the Baseline mission design refer to Table 3-14 and Appendix C.

The Mothership will release the two Elliptical smallsats during spiral down. Later, when low polar circular Mars orbit is achieved, the three Polar smallsats will also be released. The Polar smallsats will carry out a small maneuver to start nodal precession. Each Polar smallsat will do another small maneuver in order to halt precession when they reach their final a, see Figure 3-3.

Figure 3-4 details the Baseline Constellation telecommunications concept of operations. The Mothership is required to support a two-way direct-to-Earth (DTE) and direct-from-Earth (DFE) link through all mission phases, Mothership also acts as a relay using UHF to receive and send data from the Polar and Elliptical platforms. The Areo Carrier and Areo

Table 3-14. Baseline Constellation Mission Design.

Parameter	Value	Units
Launch Site	Cape Canaveral, Florida	
Total Flight Element #1 Mass with contingency (includes instruments)	2674	kg
Total Flight Element #2 Mass with contingency (includes instruments)	1226.7	kg
Propellant Mass without contingency	1548.5	kg
Propellant contingency	17	%
Propellant Mass with contingency	1818.5	kg
Launch Adapter Mass with contingency	136	kg
Total Launch Mass	4628.5	kg
Launch Vehicle	Falcon Heavy Recoverable	Type
Launch Vehicle Lift Capability	6275	kg
Launch Vehicle Mass Margin	363.6	kg
Launch Vehicle Mass Margin (%)	6%	%

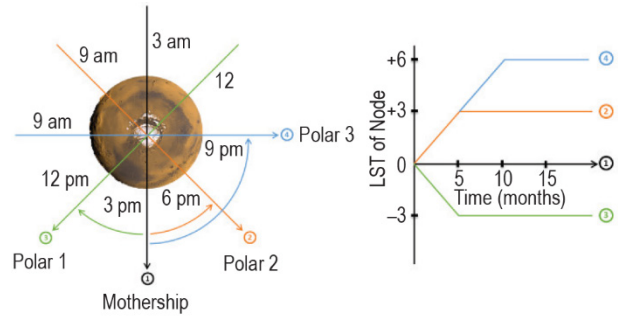

Figure 3-3. Polar platform node precession after orbit phasing.

A/B Platforms each have their own DTE and DFE links. A multi-spacecraft areostationary architecture could enhance Mars relay capability with continuous Earth line-of-sight to by at least one or more spacecraft.

Table 3-15 provides a breakdown of the data volume generated per sol by Platform. Table 3-16 details the Mission Design details of each platform in the Baseline Constellation.

Table 3-15. Platform Data Volume per Sol.

Platform	Daily Volume (Gb/Sol)
Mothership	158.3
Polar	1.4
Elliptical1	0.5
Areo Carrier	16.2
Areo A	12.8
Areo B	0.3

Mothership Platform Concept of Operations

After the hosted small spacecraft have separated, the Mothership will begin the science phase by entering into a 3 p.m. LST sun-synchronous orbit (SSO) that is circular with a 300 km altitude from the surface of Mars, analogous to MRO. Each sol, the Mothership will orbit Mars approximately 13 times with an orbital period of 114 minutes. Total baseline mission duration for science operations is two Mars years.

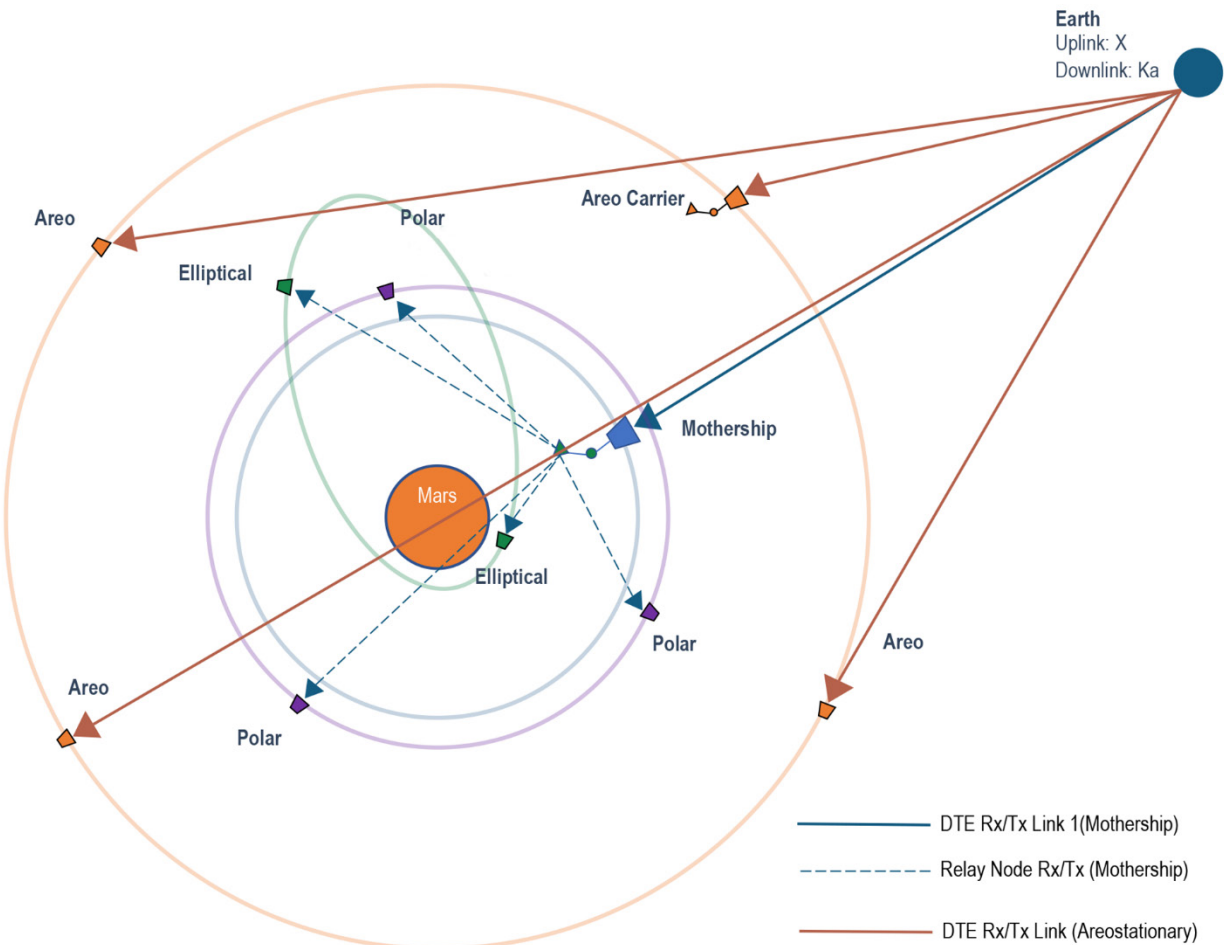

Figure 3-4. Baseline Constellation Telecommunications Concept of Operations.

The spacecraft has four operating modes during each orbital period, see Figure 3-5 and Table 3-16. The worst-case eclipse has a duration of 39 minutes long and is the driving case for the battery system size. At maximum distance from Earth the maximum data volume is 165 Gb per sol which includes data for Mothership, three Polar, and two Elliptical spacecraft, see

Table 3-17. The mothership downlink capability has a variable data rate that is a function of the range between Earth and Mars. The expected performance of the Mothership ranges 3 Mbps at 2.5 AU and 76 Mbps at 0.5 AU.

Table 3-16. Baseline Constellation Mission Design.

Parameter	Mothership Value	Polar Value	Elliptical Value	Areo Carrier Value	Areo A/B Value	Units
Orbit Parameters (apoapsis, periapsis, inclination, etc.)	Apoapsis: 300 km Periapsis: 300 km Inclination: 92.8°	Apoapsis: 300 km Periapsis: 300 km Inclination: 92.8°	Apoapsis: 170 km Periapsis: 6000 km Inclination: 75°	Apoapsis: 17031 km Periapsis: 17031 km Inclination: 0°	Apoapsis: 17031 km Periapsis: 17031 km Inclination: 0°	
Mission Lifetime	57–80*	36	36	36	36	mos
Maximum Eclipse Period	42	42	106	81	81	min

*The baseline mission science is two Mars years. In the Team X studies, some analysis, and the lifecycle mission cost one Mars year is assumed. There are no mothership platform impacts of this difference between two and one Mars years of baseline science.

Table 3-17. Mothership Mission Operations and Ground Data Systems.

Downlink Information	Launch and Early Ops	Check out and first maneuver	Cruise to Mars	Spiral In	Deployments	Continued Spiral In	Orbit Alignment	Science/Relay Orbit
Number of Contacts per Week	21	14	2	2	7	2	7	14
Number of Weeks for Mission Phase, weeks	2	2	52	13	13	26	9	130
Downlink Frequency Band, GHz	32 (Ka-band); 8.4 (X-Band)							
Telemetry Data Rate(s), kbps	0.5AU 76000 kbps; 1.5AU 8300 kbps; 2.5AU 3000kbps							
Transmitting Antenna Type(s) and Gain(s), DBi	(1) 3m X/Ka-band HGA; 57dBi gain @ K-Band; (2) X-band LGA; 8 dBi gain							
Transmitter peak power, Watts	200W Ka-band; 25W X-band							
Downlink Receiving Antenna Gain, DBi	79.37 in X/Ka Mode							
Transmitting Power Amplifier Output, Watts	18200							
Total Daily Data Volume, (Mb/sol)	160000							
Uplink Information	Launch and Early Ops	Check out and first maneuver	Cruise to Mars	Spiral In	Deployments	Continued Spiral In	Orbit Alignment	Science/Relay Orbit
Number of Uplinks per Day	21	14	2	2	7	2	7	14
Uplink Frequency Band, GHz	7.2							
Telecommand Data Rate, kbps	2							
Receiving Antenna Type(s) and Gain(s), DBi	34m BWG							

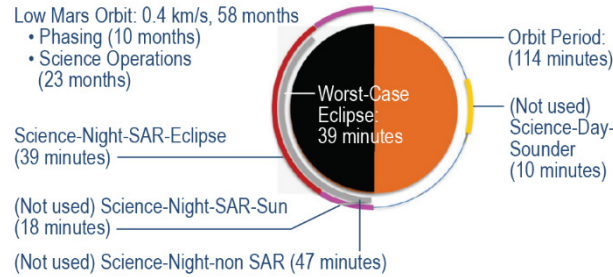

Figure 3-5. Mothership platform modes and durations.

Polar Platform Concept of Operations

The Polar platform is hosted on the Mothership during the cruise phase until arrival at a 3 p.m. LST Mars orbit. After separation, the three Polar spacecraft will separate and begin to drift away like “pearls on a string” to begin orbit phasing. From the 3 p.m. LST origin, each of the three spacecraft will change inclination by $\pm 1.7^\circ$ then drift in LST for a duration of 5–10 months (Figure 3-3). Polar spacecraft 1 will change its inclination $+1.7^\circ$ and begin to drift for 5 months to a 12 p.m. LST, consuming 100 m/s of ΔV budget; at the same time, Polar spacecraft 2 will change inclination by -1.7° and drift for 5 months to a final SSO at 6 p.m. LST; Polar spacecraft 3 will change its inclination and drift for 10 months until it has reached the final 300 km SSO at 9 p.m. LST. After drifting into place, each spacecraft will change its inclination back to 92.8° and begin science operations.

The polar platform orbital period is 114 minutes—identical to the Mothership. The orbital phase of the mission was modeled using five power modes: Science-Sun, Science-Eclipse,

Telecom, Maneuver, and Prop-Warmup, shown in Figure 3-6.

During the science phase, the thermal infrared radiometer operates continuously and generates 355 megabits of data volume per sol. The NIR spectrometer operates continuously only during orbital passes on the dayside of Mars and generates 777 megabits of data volume per sol. The radio occultation experiments include 30 occultation measurements per sol that generate up to 300 megabits per sol. 1432 megabits of total data is generated per sol.

During Telecom mode, the Polar spacecraft will transmit data via relay to the Mothership 26 times per sol for a duration of 15 minutes per telecom contact. The total daily data budget is 1521 megabits per sol.

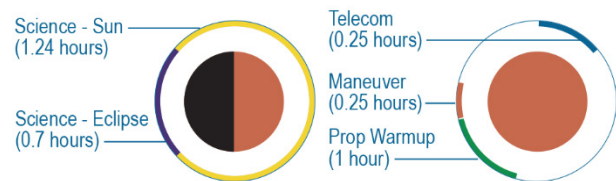

Figure 3-6. Polar platform power modes.

Elliptical Platform Concept of Operations

During cruise, the Elliptical platform is in continuous storage, drawing power from the Mothership until the elliptical separation orbit is reached: 300-km periapsis by 6000-km apoapsis and 92.8° inclination. The two Elliptical spacecraft separate from the ESPA ring and perform a maneuver sequence, see Figure 3-7. The combined maneuver begins with a plane change from 92.8° to 75° , then drops its periapsis from 300 km to 150 km, and separates true anomaly by 30° while maintaining an apoapsis of 6000 km.

The science orbit consists of five modes and has an orbital period of 264 minutes. The worst-

Table 3-18. Mothership operational modes.

Mode Name	Science-Night-SAR-Eclipse	Science-Night-SAR-Sun	Science-Night-nonSAR	Science-Day-Sounder
Duration	39 min	18 min	47 min	10 min
Spacecraft Location	LMO	LMO	LMO	LMO
Surface Illumination	Night	Night	Night	Day
Spacecraft Solar Array illumination	Eclipse	Sun	Sun	Sun
Driving Mode	Yes; drives battery sizing	No	No	No
Instruments	SAR; 5 night instruments	SAR; 5 night instruments	5 night instruments	Sounder + 7 day/night instruments

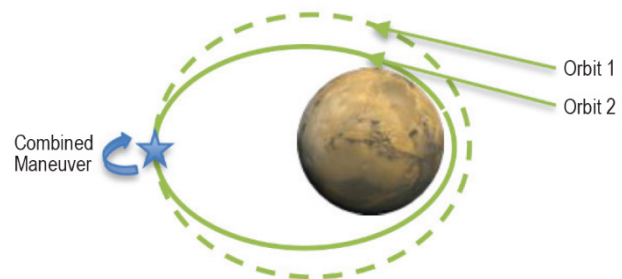

Figure 3-7. Elliptical combined maneuver.

case eclipse duration is no longer than 62 minutes long per orbit. Figure 3-8 depicts the cylindrical Elliptical platform with wraparound solar arrays and axial radio science antennas on each end of the spacecraft.

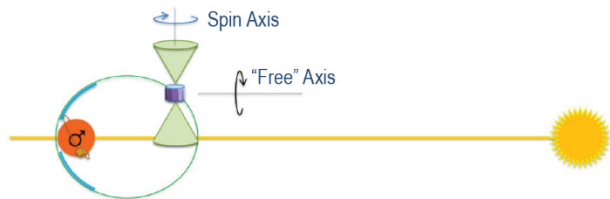

Figure 3-8. Elliptical combined maneuver.

The X-band and UHF antennas are located on only one end of the spacecraft and will be used at any given time. The Elliptical orbit will “walk” around Mars, meaning that the spacecraft will only have occultation opportunities in a few places in the orbit. The spacecraft-sun line defines one “free” axis that can be adjusted to maximize the radio science opportunities.

The Elliptical platform science instruments operate continuously and generate a total of 340 megabits of data per sol. The Elliptical platform relay their data directly to Mothership for an average of 600 to 700 minutes per sol that are distributed across many telecom opportunities of varying length. The total data relay capability of the Elliptical platform is 400 megabits per sol, which exceeds the science requirement with 18% data margin.

Areo Carrier Platform Concept of Operations

The Areo Carrier platform is host for the smaller Areo platform elements. After launch and separation from the ESPA ring after launch with a $C3 = 5\text{km}^2/\text{s}^2$, the Areo Carrier platform performs a continuous electric propulsion thrust to rendezvous with Mars on a 1-year cruise. Once at Mars, the spacecraft will spiral down to a circular 17031 km science orbit over a 3-month period.

The Areo Carrier science orbit maintains a spatiotemporal lock on Mars that is has an orbital period equal to Mars’ rotational period of 24 hours and 37 minutes. The spacecraft was assumed to perform a 180° “cartwheel” twice per orbit, to keep the instrument cables from tangling.

During science operations, the Areo Carrier spacecraft has five operational modes to meet mission requirements (Figure 3-9). The two main

science modes occur when Mars is illuminated and the latter during the Mars night and dusk.

Figure 3-10 depicts the science concept of operations. The platform has the capability to simultaneously point science instruments at the sun and at Mars. Sun-pointed instruments are co-located with the solar arrays while the nadir pointing instruments are on a single-axis articulated instrument deck.

Table 3-19 details the science concepts of operations for both Areo Carrier and Areo A/B platforms. Table 3-20 displays the details for ground systems and data for Areo Carrier.

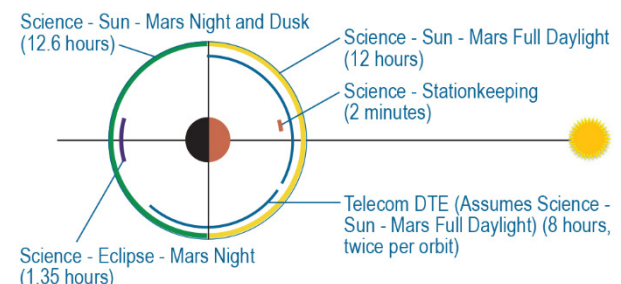

Figure 3-9. Areo Carrier science modes of operation.

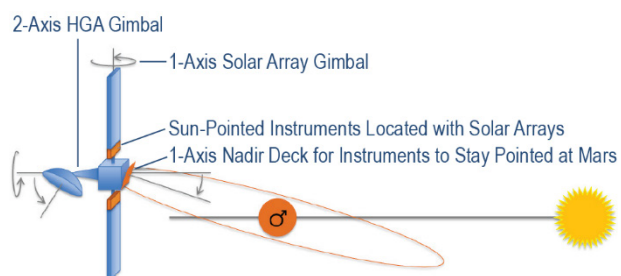

Figure 3-10. Areo carrier instrument pointing constraints.

Table 3-19. Areo Carrier and Areo A/B Instrument Concept of Operations.

Instrument	Platform	Line of Sight	Time of Operation	Measurements per Sol
Visible Imager	Areo Carrier, Areo A, Areo B	Nadir	Day	24
NIR Spectrometer	Areo Carrier, Areo A, Areo B	Nadir	Day	24
Infrared Radiometer	Areo Carrier, Areo A, Areo B	Nadir	Day/ Night	Every 2 seconds
FUV/EUV	Areo Carrier	Scan nadir	Ad-hoc	8

Table 3-19. Areo Carrier and Areo A/B Instrument Concept of Operations.

Instrument	Platform	Line of Sight	Time of Operation	Measurements per Sol
Fluxgate Magnetometer	Areo Carrier, Areo A	Omni-directional	Day/Night	Every 1 second
Ion Energy/Angle	Areo Carrier, Areo A	Omni-directional	Day/Night	Every 16 seconds
Electron/Angle Spectrometer	Areo Carrier, Areo A	Sun	Day/Night	Every 16 seconds
Energetic Ion/Electron	Areo Carrier, Areo A	Sun	Day/Night	Every 60 seconds
Extreme UV	Areo Carrier, Areo A	Sun	Day/Night	Every 16 seconds

3.4 Constellation Risk List

MOSAIC has no risks of high likelihood and high consequence and few risks of moderate likelihood and consequence. MOSAIC risks bin in two categories: development risk prior to launch, and mission risk post-launch. Constellation risks are discussed and categorized here that a future project would have control over and that would impact science return or cost. Not included are risks that typical NASA projects mitigate such as instrument delivery schedule risks (mitigated by funded schedule margin, for example). Environmental or other risks that a project would not have control over are not listed.

Table 3-22 shows the definitions of likelihood of Occurrence (L) and the Consequence (C) for Table 3-21 Constellation Risk List. Table 3-23 shows the standard definitions of the Mission Risk Consequence of Occurrence used in Table 3-21.

Table 3-20. Areo Carrier Mission Operations and Ground Data Systems.

Downlink Information	Launch and Early Ops	Check out and first maneuver	Cruise to Mars	Spiral In	Deployments	Continued Spiral In	Orbit Alignment	Science/Relay Orbit
Number of Contacts per Week	21	14	2	2	7	2	7	14
Number of Weeks for Mission Phase, weeks	2	2	52	13	13	26	9	130
Downlink Frequency Band, GHz	32 (Ka-band); 8.4 (X-Band)							
Telemetry Data Rate(s), kbps	290							
Transmitting Antenna Type(s) and Gain(s), DBi	(1) 1m X/Ka-band HGA; 48.3 dBi gain @ K-Band; (1) MGA 36.6 dBi gain;							
Transmitter peak power, Watts	250W Ka-band; 20W X-band							
Downlink Receiving Antenna Gain, DBi	79.37 in X/Ka Mode							
Transmitting Power Amplifier Output, Watts	18200							
Total Daily Data Volume, (Mb/sol)	16195							
Uplink Information	Launch and Early Ops	Check out and first maneuver	Cruise to Mars	Spiral In	Deployments	Continued Spiral In	Orbit Alignment	Science/Relay Orbit
Number of Uplinks per Day	21	14	2	2	7	2	7	14
Uplink Frequency Band, GHz	7.2							
Telecommand Data Rate, kbps	2							
Receiving Antenna Type(s) and Gain(s), DBi	34m BWG							

Table 3-21. Risk table elaborates constellation risks. Note that further detail on probability of success high-level analysis is in Appendix C.

#	Risk	Category Impl/Msn	L × C*	Mitigation	Residual L × C*
1	One type of smallsat platform (Areo Carrier, Areo SmallSat A or B, Polar, Elliptical) is late to constellation integration	Imp	2 × 4	Start all smallsat platform procurements earlier than needed. This is possible since Mothership development schedule is longer and drives constellation integration.	1 × 1
2	One Elliptical spacecraft fails before reaching beginning of baseline science ¹	Msn	2 × 3	Accept approximately factor of two radio science occultation reduction.	1 × 1
3	One Elliptical spacecraft fails before reaching beginning of baseline science ¹	Imp	2 × 3	Launch one additional Elliptical spacecraft (for a total of three) at an additional cost of \$19M-\$48M (FY25) (see Appendix B Team Xc report, cost section for elliptical spacecraft).	1 × 1
4	One Polar spacecraft fails before reaching beginning of baseline science ¹	Msn	2 × 3	Accept minimal radio science occultation reduction.	1 × 1
5	One Polar spacecraft fails before reaching beginning of baseline science ¹	Imp	2 × 3	Launch one additional Polar spacecraft (for a total of four) at an additional cost of \$14M-\$35M (FY25) (see Appendix B Team Xc report, cost section for polar spacecraft).	1 × 1
6	One areostationary spacecraft fails before reaching beginning of baseline science ¹	Imp	2 × 3	Launch one additional areostationary spacecraft (for a total of five) at an additional cost of \$60M-\$151M (FY25) (see Appendix B Team Xc report, cost section for areostationary spacecraft).	1 × 1
7	Mothership fails before start of constellation science, but after deployment of three Polar spacecraft ¹	Msn	1 × 5	Use limited areostationary relay capability, or other non-MOSAIC orbiter relay capability, with possible reduction in science data return.	1 × 4
8	Mothership fails before start of constellation science, but after deployment of three Polar spacecraft ¹	Imp	1 × 5	Fly additional “mini” mothership with reduced science payload and smaller direct-to-Earth (DTE) science data relay volume (see Appendix B, Team X follow-on report).	1 × 3
9	Replenish one failed Elliptical, Polar, or areostationary spacecraft at next possible Mars launch opportunity ²	Imp	1 × 5	Build-to-print spacecraft and payload likely ready for launch at failure plus two years. In science orbit at failure plus four years. Cost to mitigate by replenishment varies from \$107M to \$568M (FY 25).	1 × 1

¹ The probability of constellation success to return baseline science is from around 90% to almost 100% not taking into account launch, cruise, spiral down, and deployment (see Appendix C, probability of success subsection).

² The total mission cost to replenish one polar spacecraft (assumes carried to low Mars orbit) is \$107M FY 25 (see Appendix B, of the Team Xc report). The total mission cost to replenish one elliptical spacecraft (assumes carried to elliptical Mars orbit) is \$158M FY 25. The total mission cost to replenish one areo carrier spacecraft is \$568M FY 25. All of these estimates assume no build-to-print savings.

Table 3-22. Likelihood of Occurrence.

Level	Description	Level Definition	Percentage
5	Very High	Almost certain	70% < x ≤ 100%
4	High	More likely than not	50% < x ≤ 70%
3	Moderate	Significant likelihood	10% < x ≤ 50%
2	Low	Unlikely	1% < x ≤ 10%
1	Very Low	Very unlikely	X ≤ 1%

Table 3-23. Mission Risk Consequence of Occurrence.

Level	Description	JPL Mission Risk Definitions	Project Specific Clarification Related to Requirements
5	Very High	Mission Failure	Does not acquire significant mission science (or meet other objectives).
4	High	Significant reduction in mission return	Acquires significant science (or meets other objectives) but does not meet Threshold requirements.
3	Moderate	Moderate reduction in mission return	Meets Threshold Requirements but does not meet Baseline requirements.
2	Low	Small reduction in mission return	Meets Baseline requirements.
1	Very Low	Minimal reduction in mission return	Only minor loss of mission science (or objectives).

4 Development Schedule and Schedule Constraints

MOSAIC development follows the longest flagship class schedule for the Mothership, which also covers the development, integration, and launch of the complete ten constellation spacecraft.

4.1 High-Level Mission Schedule

MOSAIC will approximate a flagship mission development schedule, with a development (Phase A–D) cycle spanning roughly eight years. The Mothership will have the longest development cycle, and therefore span the other platform development schedules. Phases A and B are expected to last 15 months, and Phases C and D 41 and 23 months, respectively (Table 4-1). The Phase A–C durations of the smaller satellites are significantly shorter than that of the Mothership (about half), and their development can be adjusted accordingly within the development period of the Mothership. Launch preparations in Phase D would be augmented for constellation integration and tests.

Due to the nature of SEP-enabled low-thrust Earth-Mars transfers, launch dates are not rigidly confined to the standard 26-month ballistic transfer cycle. Launches may occur at almost any time, but the optimal arrival time still roughly follows 2-year cycle (Woolley et al. 2019). This means that a launch slip of one year would likely result in a 2-year delay in the arrival at the science orbit.

Table 4-1. MOSAIC development timeline.

Project	Description	Duration (Months)	Launch ±/ (yrs)
Phase A	Project Definition	15	-7.8
Phase B	Preliminary Design	15	-6.6
Phase C	Design and Fabrication	41	-5.3
Phase D	Integration and Test	23	-1.9
Development Total		94	
Phase E	Operations	80*	6.7
Phase F	Closeout	4	7.0

*The baseline mission science is two Mars years. In the Team X studies, some analysis, and the lifecycle mission cost one Mars year is assumed. There are no impacts of this difference between two and one Mars years of baseline science.

Figure 4-1 shows the phases and durations associated with a reference trajectory to Mars. Shortly after launch, the Mothership (carrying the Polar and Elliptical satellites) and the Areo platform group separate (FO 2-1), using their respective SEP engines to thrust towards Mars. Many factors influence the duration of the cruise and spiral stages of each spacecraft, such as launch year, mass, power level, thruster choice, and trajectory optimization. The cruise phase lasts 16–24 months and is usually longer for areostationary platforms, mostly due to the length of the spiral down phase to areostationary orbit. This allows both spacecraft clusters to arrive in their final orbits around the same time—approximately two years after launch.

The Elliptical and Polar spacecraft are deployed towards the end of the Mothership’s spiral phase. In the case of the Polar satellites, the only cost-effective way to shift their orbital planes

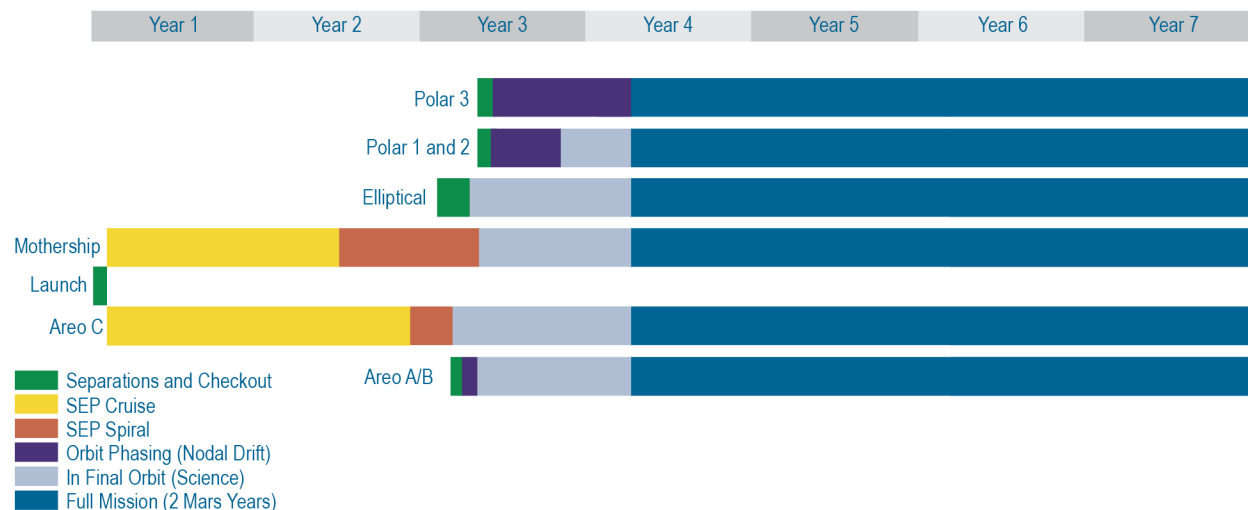

Figure 4-1. Example timeline for the MOSAIC constellation.

is by taking advantage of the natural nodal drift induced by Mars’ gravity. This means that a 90° shift for one of the satellites could take up to 10 months. While this drift is occurring (the large purple bar in Figure 4-1), all of the satellites can continue to perform nominal science operations. Once all of the elements are in their final orbits (about 3 years after launch), the baseline mission begins and lasts for at least two Mars years.

4.2 Technology Development Plan

MOSAIC spacecraft and instrument technologies currently at TRL 5 or less are described here to highlight the current TRL of key technologies, as well as the time and investment needed to achieve TRL 6. The MOSAIC constellation platforms require few technology developments (Table 4.2). Note that deep space and Earth orbiting smallsat technology developments are occurring at a rapid pace. MOSAIC anticipates that within the decade these smallsat technologies will be commonplace. The Areo Carrier MaSMI SEP thruster is currently at TRL 5 and is expected to be TRL 6 within two years. The Polar smallsat green propellant propulsion system is currently at TRL 6 and several equivalent subsystems have flown or will fly for Earth orbit applications within the next two years. Return of MOSAIC data to Earth does not require optical communication. If optical communication continues to mature, MOSAIC and future Mars constellations can benefit from the increased data return possibilities. All other spacecraft technologies are currently at TRL 6 or greater.

Table 4-2. Spacecraft technologies requiring further development (TRL 5 or less). M=Mothership, AC=Areo Carrier, AS=Areo SmallSat A or B, E=Elliptical, P=Polar.

Platform	Technology	Current TRL	Time to TRL 6	\$'s (FY 25) to TRL 6
AC, AS	MASMI SEP thruster	5	2 yr	\$200K
E, P	Hydrazine delta-V propulsion	5	1 yr	None, in work by several companies
M, AC	Optical Communication	5	2 yrs	\$10M

For those instrument technologies at TRL 5 or less listed in Table 2-4, Table 4-3 lists the funding needed to bring the technology to TRL 6, the amount of funded time needed to bring to TRL 6 (see Appendix B and D for more detail).

Table 4-3. Instrument technologies at TRL 4 or TRL 5 requiring further development as of July 2020. Time to TRL6 is from funded start.

Instrument Technology	Current TRL	Time to TRL 6	\$'s (FY 25) to TRL 6
P-SAR/Sounder 6m mesh antenna	5	1 yr	\$1M
MAVRIC	5	1 yr	\$200K
MARLI	5	1 yr	\$200K
Sub-mm Sounder	5	6 mon	\$50K
Wind Doppler Interferometer	5	9 mon	\$3M
Radio Occultation Smallsat USO	5	3 yrs	\$3M
Extreme Ultraviolet Monitor	4	6 mon	\$100K

4.3 Development Schedule and Constraints

MOSAIC includes ten flight systems assembled, tested, and integrated into the launch vehicle stack. Each of the flight systems is assembled and tested independently before launch vehicle integration at the launch site. Table 4-1 describes the overall MOSAIC development schedule, driven by the Class B mothership. The Class D Polar, Elliptical, and Areo platforms have a shorter development schedule described in Table 4-4.

Table 4-4. MOSAIC Class D spacecraft development timeline starts later and ends at the same time as Table 4-1.

Development Phase	Description	Duration (months)
Phase A	Project Definition	7
Phase B	Preliminary Design	7
Phase C	Design and Fabrication	17
Phase D	Integration and Test	15
Development Total		46

5 Mission Life-Cycle Cost

The MOSAIC ten-spacecraft constellation uses traditional point design and “new space smallsat” cost estimates to provide a cost range.

MOSAIC mission life-cycle cost estimates benefit from many previous Mars science orbiter studies, as well as currently-ongoing missions. CML 3 trade space exploration uses regression analysis that allows cost estimate ranges to inform payload and architecture decisions for selection of CML 4 point designs (see Table 2-2 for CML definitions). Each CML 4 point design leverages two or more independent model methods to ensure a robust cost basis. The MOSAIC constellation mission provides baseline and reduced science options with platforms, some of which fit into a New Frontiers-scale mission cost. Modularity and non-NASA funded elements are both possible to emplace the constellation.

CML 3 trade space exploration utilized cost estimates provided by the JPL study team, and the JPL Innovation Foundry early concept teams (A Team and Team X). Appendix B contains the A Team summary report. The A Team CML 3 trade space exploration resulted in a selection of the baseline mothership (Architecture 7 in Appendix B, A Team study report, Table B-7) and a descope 1 mothership (Architecture 12 in Appendix B, A Team study report, Table B-7) for further point design study in Team X (Appendix B-4).

5.1 Costing Methodology and Basis of Estimate

The MOSAIC team and JPL’s Team X (Advanced Projects Design Team) explored two constellation architecture options for technical and financial feasibility. The two options, baseline and descope 1 mission, vary the mothership payload and the subsequent mothership platform (see Appendix B.4). As a follow-on to the Team X study, an additional system-level sizing study produced technical and cost for a mothership that does not carry the polar and elliptical smallsats to low Mars orbit. This information is used for the constellation risk list (see Section 3.4). The cost team worked interactively to determine an initial assessment of technical risk, as well as consistent cost and schedule.

The baseline constellation estimated the mothership with a Class A flagship designation. The other nine constellation spacecraft used a Class D designation (single string). The descope 1 mission constellation reduced the mothership payload which results in a Class B designation. The other nine constellation spacecraft have a Class D designation. Both the baseline and descope 1 mission have costs for the entire constellation, as well as “modular” cost estimates for platforms within the constellation.

Team X estimates are generally model-based, and the process includes multiple methods and databases relating to past space systems so that no one model or database biases the results. Also, Team X used analogy-based estimating methodologies; tie costs and schedule estimates by Work Breakdown Structure (WBS) to NASA systems that have already been built and that thus have a known cost and schedule. In other words, it provides an independent estimate of the cost and complexity of new concepts anchored with respect to previously built flight systems hardware. In summary, the use of system-level estimates and arriving at total estimated costs by statistically summing the costs of all individual work breakdown structure elements ensures that elements are not omitted and that the system-level complexity is properly represented in the cost estimate.

All instruments’ estimates were derived from the NASA Instrument Cost Model (NICM), based on objective inputs against Cost Estimation Relationship (CER) of families of instruments types (see Appendix D). MOSAIC uses a PSYCHE SEP system analogy for cost.

Team X final study reports, which include details for costing assumptions and basis of estimate, are in Appendix B. Note that the Appendix B Team X reports preamble contains information to understand the Team X studied options. The cost information contained in this document is of a budgetary and planning nature and is intended for informational purposes only. It does not constitute a commitment on the part of JPL and/or Caltech.

5.2 Cost Estimate(s)

Costs were estimated using the standard NASA WBS at level 3 for all elements, and defined at

level 4 for the flight systems and payload due to the in-depth knowledge and details of each subsystems.

Table 5-1 summarizes baseline mission and descope 1 mission lifecycle costs for different cost reserve assumptions. Table 5-2 details the baseline mission constellation lifecycle cost using traditional methods. Table 5-3 details the baseline lifecycle constellation cost using “new space” commercially purchased smallsats. Table 5-4 and Table 5-5 shows the lifecycle cost of the descope 1 mission for traditional and “new space” commercial, respectively. The costs are in FY\$25 and have separate estimates for Development (Phases A–D) and Operations (Phases E–F). Cost estimate include Launch Vehicle Services at a value of \$274.6M FY25 per NASA PMCS guidance (see Appendix D.5). As required by NASA Groundrules for Mission Concept Studies, cost reserves are applied 50% for Phases A–D and 25% for Phase E–F. Also included is a cost reserve of 30% Phases A–D, and 15% Phases E-F, for easier comparison to other non-PMCS study costs.

As another approach to estimate costs, JPL’s business organization evaluated MOSAIC with parametric models supplemented with analogies and wrap factors based on historical data. The cost model used include System Evaluation and Estimate of Resources (SEER), TruePlanning, and Small Satellite Cost Model (SSCM) for Phase

A–D, and SOCM for Phase E. The parametric cost models use CERs derived from historical data of similar space programs and projects.

Table 5-2 through Table 5-5 shows the JPL Team X baseline and descope 1 mission cost estimates, as well as the System Evaluation and Estimate of Resources-Hardware (SEER-H) and TruePlanning model estimates. In addition to these two parametric models, SSCM was used to estimate the Polar, Elliptical, Areo carrier, and Areostationary SmallSats A and B platforms that were included in the baseline and descope 1 mission costs (see Table 5-6).

The parametric cost models provide Development and Operation cost estimates, and, for comparison to Team X, Phase A values were assumed to be \$5M based on an escalated value of the Phase A cost from the New Frontiers 4 Announcement of Opportunity (AO). The multiple model approaches provide confidence that these MOSAIC costs are reasonable and realistic. The validation estimates range from 4% to 6%, providing credibility to the MOSAIC costs presented in this study. The validation approaches included parametric model (SSCM) estimates of the smallsats that are integrated in the roll up cost of the whole constellation that included the mothership and the payloads (see Appendix D).

Table 5-1. Baseline Constellation and Descope 1 Constellation.

	Baseline Constellation (FY25\$M)						Descope 1 Constellation (FY25\$M)							
	Estimate	Reserves	Total	Reserves	Total		Estimate	Reserves	Total	Reserves	Total			
Development (A–D)*	2315.5	30%	694.65	3010.2	50%	1157.8	3473.3	1592.3	30%	477.7	2070.0	50%	796.1	2388.4
Mothership (1)	586.8	30%	176.0	762.8	50%	293.4	880.2	419.6	30%	125.9	545.5	50%	209.8	629.4
Polar Platform (3)	57.9	30%	17.4	75.3	50%	29.0	86.9	57.9	30%	17.4	75.3	50%	29.0	86.9
Elliptical Platform (2)	53.0	30%	15.9	68.9	50%	26.5	79.5	53.0	30%	15.9	68.9	50%	26.5	79.5
Areostationary Platform (4)	172.7	30%	51.8	224.5	50%	86.4	259.1	172.7	30%	51.8	224.5	50%	86.4	259.1
Others Develop. Costs	1,445.1	30%	433.5	1878.6	50%	722.6	2167.7	889.1	30%	266.7	1155.8	50%	444.5	1,333.6
Launch Vehicle	274.6	-	-	274.6	-	-	274.6	274.6	-	-	274.6	-	-	274.6
Operations (E/F)	377.5	15%	56.6	434.1	25%	94.4	471.9	328.0	15%	49.2	377.2	25%	82.0	410.1
Full Lifecycle Cost	2967.6	28%	751.3	3718.8	46%	1252.1	4219.7	2194.9	27%	526.9	2721.8	46%	878.1	3073.0

Table 5-2. Model Cost Assessment for MOSAIC Baseline Constellation (FY25 \$M).

WBS Element Baseline Constellation	Team X	Method 1 (SEER-H/SSCM)	Method 2 (TruePlanning/SSCM)	Deltas Team X vs. Method 1 (%)	Deltas Team X vs. Method 2 (%)
Phase A	Incl. in B–D	5.0	5.0		
Phase B–D Development	2590.1	2479.2	2804.1		
WBS 01-03 PM/PSE/SMA	332.3	293.7	259.5	13%	28%
WBS 04,07/09 Science/ Mission Operation Systems (MOS)/ Ground Data Systems (GDS)	239.6	219.4	251.7	9%	–5%
WBS 05 PL System	686.8	684.0	643.1	0%	7%
WBS 06&10 FS & Assembly, Test, and Launch Operations (ATLO)	1056.8	1007.6	1375.2	5%	–23%
*WBS 08 Launch Vehicle (LV) Services	274.6	274.6	274.6		
Subtotal A–D w/o Reserve	2590.1	2484.2	2809.1	4%	–8%
Phases A–D Reserve (50% of A–D excl LV)	1157.8	1104.8	1267.3	5%	–9%
Subtotal A–D with Reserve	3747.8	3589.0	4076.4	4%	–8%
Phase E/F Operation	377.5	327.5	327.5	15%	15%
Phase E/F Reserve (25% of E/F)	94.4	81.9	81.9	15%	15%
Subtotal E/F with Reserve	471.9	409.3	409.3	15%	15%
Total Mission w/ Reserve	4219.7	3998.3	4485.7	6%	–6%

* WBS 08 estimate from NASA PMCS Study Ground Rules. MOSAIC assumed a potential use of Falcon Heavy Recoverable.

Table 5-3. New-Space Commercial Cost Method for MOSAIC Baseline Constellation (FY25 \$M).

WBS Element Baseline Constellation with New-Space Method for Smallsats	Team X	**New-Space Commercial Method (Triangle Distr.)	Deltas Team X vs. Space Method (\$)	Deltas Team X vs. Space Method (%)
WBS 01-03 PM/PSE/SMA	332.3	318.7	13.6	4%
WBS 04,07/09 Science/MOS/GDS	239.6	239.6	–	
WBS 05 PL System	686.8	686.8	–	
WBS 06&10 FS/ATLO	1056.8	964.2	92.6	10%
WBS 06.01&06.02 FSM/FSSE	96	87.6	8.4	10%
Mothership Bus	601.8	601.8	–	
Polar SmallSats (3)	57.9	48.0	9.9	21%
Elliptical SmallSats (2)	53.0	42.0	11.0	26%
Areo Carrier (1)	121.2	68.0	53.2	78%
Areostationary SmallSats A & B (3)	51.5	48	3.5	7%
WBS 10 ATLO	75.4	68.8	6.6	10%
*WBS 08 LV Services	274.6	274.6	–	
Subtotal A–D w/o Reserve	2590.1	2483.8	106.3	4%
Phases A–D Reserve (50% of A–D excl LV)	1157.8	1104.6	53.1	5%
Subtotal A-D with Reserve	3747.8	3588.4	159.4	4%
Phase E/F Operation	377.5	377.5	–	
Phase E/F Reserve (25% of E/F)	94.4	94.4	–	
Subtotal E/F with Reserve	471.9	471.9	–	–
Total Mission w/ Reserve	4219.7	4060.3	159.4	4%

* WBS 08 estimate from NASA PMCS Study Ground Rules. MOSAIC assumed a potential use of Falcon Heavy Recoverable.

** Uses low value in Team X triangle cost distribution. See Appendix B for details.

Table 5-4. Model Cost Assessment for MOSAIC Descope 1 Constellation (FY25 \$M).

WBS Element Descoppe 1 Constellation	TeamX	Method 1 (SEER-H/SSCM)	Method 2 (TruePlanning/SSCM)	Deltas Team X vs. Method 1 (%)	Deltas Team X vs. Method 2 (%)
Phase A	Incl. in B–D	5.0	5.0		
Phase B–D Development	1866.8	1759.4	1981.7		
WBS 01-03 PM/PSE/SMA	255.4	197.6	159.0	29%	61%
WBS 04,07/09 Science/MOS/GDS	180.7	147.8	169.9	22%	6%
WBS 05 PL System	294.1	267.3	246.0	10%	20%
WBS 06&10 FS & ATLO	862.0	872.2	1132.3	-1%	-24%
*WBS 08 LV Services	274.6	274.6	274.6		
Subtotal A-D w/o Reserve	1866.8	1764.4	1986.7	6%	-6%
Phases A–D Reserve (50% of A–D excl LV)	796.1	744.9	856.1	7%	-7%
Subtotal A-D with Reserve	2663.0	2509.4	2842.8	6%	-6%
Phase E/F Operation	328.0	290.1	290.1	13%	13%
Phase E/F Reserve (25% of E/F)	82.0	72.5	72.5	13%	13%
Subtotal E/F with Reserve	410.1	362.6	362.6	13%	13%
Total Mission w/ Reserve	3073.0	2872.0	3205.4	7%	-4%

* WBS 08 estimate from NASA PMCS Study Ground Rules. MOSAIC assumed a potential use of Falcon Heavy Recoverable

Table 5-5. New-Space Commercial Cost Method for MOSAIC Descope 1 Constellation (FY25 \$M).

WBS Element Descoppe 1 Constellation with New-Space Method for Smallsats	Team X	**New-Space Commercial Method (Triangle Distr.)	Deltas Team X vs. Space Method (\$)	Deltas Team X vs. Space Method (%)
WBS 01-03 PM/PSE/SMA	255.4	240.57	14.8	6%
WBS 04,07/09 Science/MOS/GDS	180.7	180.74	-	
WBS 05 PL System	294.1	294.1	-	
WBS 06&10 FS/ATLO	862.0	768.4	93.6	12%
WBS 06.01&06.02 FSM/FSSE	75.7	67.5	8.2	12%
Mothership Bus	430.6	430.6	-	
Polar SmallSats (3)	57.9	48.0	9.9	21%
Elliptical SmallSats (2)	53.0	42.0	11.0	26%
Areostationary Mothership Bus (1)	121.2	68.0	53.2	78%
Areostationary SmallSats (3)	51.5	48	3.5	7%
WBS 10 ATLO	72.2	64.4	7.8	12%
*WBS 08 LV Services	274.6	274.6	-	
Subtotal A–D w/o Reserve	1866.8	1758.4	108.4	6%
Phases A–D Reserve (50% of A–D excl LV)	796.1	741.9	54.2	7%
Subtotal A–D with Reserve	2663.0	2500.3	162.6	7%
Phase E/F Operation	328.0	328.0	-	
Phase E/F Reserve (25% of E/F)	82.0	82.0	-	
Subtotal E/F with Reserve	410.1	410.1	-	-
Total Mission w/ Reserve	3073.0	2910.4	162.6	6%

* WBS 08 estimate from NASA PMCS Study Ground Rules. MOSAIC assumed a potential use of Falcon Heavy Recoverable.

** Uses low value in Team X triangle cost distribution. See Appendix B for details.

Table 5-6. Polar, Elliptical, Areo Carrier, and Areo Smallsats A and B Cost Validation (FY25 \$M). MOSAIC smallsat platform costs validate well with SSCM model estimates.

Description	Team X	SSCM	Delta Team X vs. SSCM (%)
Polar (3)	57.9	47	23%
Elliptical* (2)	53.0	85.1	-38%
Areo Carrier (1)	121.2	121.3	0%
Areo Smallsats A and B (3)	51.5	49.4	4%

* See Appendix D, Table D-20 for THEMIS analogy.

To create a mission cost funding profile, historical missions were analyzed to define representative profiles by phases. The analogous mission set includes the Mars Exploration Rover (MER) and Mars Science Laboratory (MSL) rovers, and a selection of competed Discovery and New Frontiers missions. The normalized percentage spreads were then used to phase the Team X estimate over the duration of 60 months for Phase B–D development and similarly for the 4–5 year duration for Phase E. The base year profile was then escalated to real year dollars using the JPL Composite Inflation Index. Table 5-7 and Table 5-8 shows the total mission cost funding profile for the baseline and descope 1 MOSAIC Constellations.

5.3 Potential Cost-Saving Options

For the MOSAIC constellation, the largest potential for cost savings is in the area of the smallsat platforms. If trends for commercially available Earth-orbiting smallsat platforms continue and are realized for deep space, the resulting cost savings are significant. Another area of large potential cost savings is in smallsat instrumentation. If instrumentation costs continue to reduce, this is also significant, especially when combined with the potential smallsat platform cost savings. Lesser areas of potential cost reduction identified in the Team X studies (see Appendix B for detail) are: science data analysis, on-board and ground data system software, and mechanical structure and mechanisms.

Table 5-7. Total Mission Cost Funding Profile (\$M) for the MOSAIC Baseline Constellation (FY cost in Real Year Dollars. Total in Real Year and FY25 Dollars).

Item	FY21	FY22	FY23	FY24	FY25	FY26	FY27	FY28	FY29	FY30	FY31	FY32	FY33	Total (RY\$M)	Total (FY25\$M)
Cost															
Phase A Concept Study	4.5	-	-	-	-	-	-	-	-	-	-	-	-	4.5	5.0
Phase A Tech. Dev.	-	-	-	-	-	-	-	-	-	-	-	-	-	-	-
Phase B–D Development	-	168.2	574.4	725.7	443.7	245.5	100.4	-	-	-	-	-	-	2257.9	2310.5
Phase B–D Reserves	-	84.3	287.8	363.6	222.3	123.0	50.3	-	-	-	-	-	-	1131.4	1157.8
Total A–D Development Cost	4.5	252.5	862.1	1089.3	666.1	368.5	150.7	-	-	-	-	-	-	3393.8	3473.3
Launch Services	-	-	43.4	44.6	45.8	47.0	48.3	49.7	-	-	-	-	-	278.8	274.6
Phase E Science	-	-	-	-	-	30.5	15.8	16.3	16.7	17.2	17.7	18.2	-	132.5	119.7
Other Phase E Cost	-	-	-	-	-	65.7	34.1	35.1	36.1	37.1	38.1	39.2	-	285.5	257.8
Phase E Reserves	-	-	-	-	-	24.1	12.5	12.8	13.2	13.6	14.0	14.4	-	104.5	94.4
Total Phase E Cost	-	-	-	-	-	120.3	62.5	64.2	66.0	67.9	69.8	71.8	-	522.5	471.9
Education/ Outreach	-	-	-	-	-	-	-	-	-	-	-	-	-	-	-
EPO Phase B–D	-	-	-	-	-	-	-	-	-	-	-	-	-	-	-
EPO Phase E	-	-	-	-	-	-	-	-	-	-	-	-	-	-	-
Other (specify)	-	-	-	-	-	-	-	-	-	-	-	-	-	-	-
Total Cost	4.5	252.5	905.6	1133.9	711.8	535.8	261.5	113.9	66.0	67.9	69.8	71.8	-	4195.1	4219.7
Total Mission Cost														4195.1	4219.7

Table 5-8. Total Mission Cost Funding Profile (\$M) for the MOSAIC Descope 1 Constellation (FY cost in Real Year Dollars. Total in Real Year and FY25 Dollars).

Item	FY21	FY22	FY23	FY24	FY25	FY26	FY27	FY28	FY29	FY30	FY31	FY32	FY33	Total (RY\$M)	Total (FY25\$M)
Cost															
Phase A Concept Study	4.5	-	-	-	-	-	-	-	-	-	-	-	-	4.5	5.0
Phase A Tech. Dev.	-	-	-	-	-	-	-	-	-	-	-	-	-	-	-
Phase B–D Development	-	115.6	394.6	498.5	304.8	168.6	69.0	-	-	-	-	-	-	1551.1	1587.3
Phase B–D Reserves	-	58.0	197.9	250.0	152.9	84.6	34.6	-	-	-	-	-	-	778.0	796.1
Total A–D Development Cost	4.5	173.5	592.5	748.6	457.7	253.2	103.6	-	-	-	-	-	-	2333.6	2388.4
Launch Services	-	-	43.4	44.6	45.8	47.0	48.3	49.7	-	-	-	-	-	278.8	274.6
Phase E Science	-	-	-	-	-	-	13.7	9.8	10.0	10.3	10.6	10.9	-	65.4	58.0
Other Phase E Cost	-	-	-	-	-	-	63.9	45.5	46.8	48.1	49.5	50.9	-	304.7	270.0
Phase E Reserves	-	-	-	-	-	-	19.4	13.8	14.2	14.6	15.0	15.5	-	92.5	82.0
Total Phase E Cost	-	-	-	-	-	-	97.1	69.1	71.0	73.1	75.1	77.3	-	462.7	410.1
Education/ Outreach	-	-	-	-	-	-	-	-	-	-	-	-	-	-	-
EPO Phase B–D	-	-	-	-	-	-	-	-	-	-	-	-	-	-	-
EPO Phase E	-	-	-	-	-	-	-	-	-	-	-	-	-	-	-
Other (specify)														-	-
Total Cost	4.5	173.5	635.9	793.1	503.5	300.3	249.0	118.8	71.0	73.1	75.1	77.3	-	3075.1	3073.0
Total Mission Cost														3075.1	3073.0

Appendix A Acronyms

A&IT	Assembly Integration and Test
AC	Alternating Current
ACS	Altitude Combustion Stand
AEPS	Advanced Electric Propulsion System
ALHAT	Autonomous Landing Hazard Avoidance Technology
AMMOS	Advanced Multi-Mission Operations System
AO	Announcement of Opportunity
APL	Applied Physics Laboratory
ARM	Asteroid Retrieval Mission
ARRM	Asteroid Robotic Redirect Mission
ATLO	Assembly, Test, and Launch Operations
ATM	Atmosphere
AU	Astronomical Units
B&B	Burn & Break-up
BIRCHES	Broadband InfraRed Compact, High-resolution Exploration Spectrometer
BOE	Basis of Estimate
BOL	Beginning of Life
BOM	Beginning of Mission
BS	Band Shoulder
BTE	Bench Test Equipment
BWG	Beam Waveguide
C&DH	Command and Data Handling
CADRe	Cost Analysis Data Requirement
CBE	Current Best Estimate
CDH	global change to C&DH
CDS	Command and Data Subsystem
CEPCU	Compute Element Power Converter Unit
CER	Cost Estimation Relationship
CME	Coronal Mass Ejection
CML	Concept Maturity Level
CMOS	Complementary Metal-Oxide Semiconductor
COTS	Commercial Off-the-Shelf
COVID	Coronavirus
CPCI	Computer Program Configuration Item
CPU	Central Processing Unit
CRC	Controller System Control
CRISM	Compact Reconnaissance Imaging Spectrometer for Mars
CTX	Context Camera
DASH	Doppler Asymmetric Spatial Heterodyne
DC	Direct Current
DEF	direct-from-Earth
DIU	Diurnal
DPU	Data Processing Unit

DSN	Deep Space Network
DSOC	Deep Space Optical Communication
DTE	direct-to-Earth
DTE	Data Terminal Equipment
DTN	Delay Tolerant Networking
DTU	Danish Technical University
DV	delta-V
E	energy
EDL	Entry, Descent and Landing
EELV	Evolved Expendable Launch Vehicle
EGSE	Electrical Ground Support Equipment
EM	Engineering Model
EOL	End of Life
EP	Electrical Power
EPS	Electrical Power System
ESA	ElectroStatic Analyzer
ESA	European Space Agency
EscaPADE	Escape and Plasma Acceleration and Dynamics Explorers
ESPA	EELV Secondary Payload Adapter
EUV	Extreme Ultraviolet
EUVM	Extreme Ultraviolet Monitor
EXO	Exosphere
FFT	Fast Fourier Transform
FLT	Flight Laser Transceiver
FO	Foldout
FOV	Field of View
FS	Flight System
FSOC	Free Space Optical Communication
FSW	Flight Software
FUV	Far-Ultraviolet
FWHM	Full-Width at Half-Maximum
FY	Fiscal Year
GaA	Gallium Arsenide
GDS	Ground Data Systems
GFA	Gap-Filling Activities
GID	Guidance Interface Driver
GLR	Ground Laser Receiver
GLT	Ground Laser Transmitter
GNC	Guidance, Navigation, and Control
GSE	Ground Support Equipment
GSFC	Goddard Space Flight Center
H	hydrogen
H/W	Hardware
HDO	deuterated water vapor

HDR	High Data Rate
HEPA	High-Efficiency Particulate Air
HGA	High-Gain Antenna
HH	horizontal-horizontal
HiRISE	High Resolution Imaging Science Experiment
HMR	Heat Microbial Reduction
HPCU	Housekeeping Power Converter Unit
HPE	High Photon Efficiency
HQ	Headquarters
HV	horizontal-vertical
I&T	Integration and Test
ICE-SAG	Ice and Climate Evolution Science Analysis Group
ICON	Ionospheric Connection
IFOV	Instantaneous Field of View
IMF	Interplanetary Magnetic Field
IMU	Inertial Measurement Unit
InGaA	Indium Gallium Arsenide
IONO	Ionosphere
IPS	Integrated Propulsion System
IR	Infrared
ISO	International Organization for Standardization
Isp	Specific Impulse
ISRU	In Situ Resource Utilization
IUVS	Imaging Ultraviolet Spectrometer
JAXA	Japan Aerospace Exploration Agency
JHU	Johns Hopkins University
JPL	Jet Propulsion Laboratory
K	temperature
KBases	Knowledge Bases
KSC	Kennedy Space Center
LCC	Life Cycle Cost
LCRD	Laser Communication Relay Demonstration
LDR	Low Data Rate
LGA	Low Gain Antenna
LiDAR	Light Detection and Ranging
LLCD	Lunar Laser Communication Demonstration
Ls	solar longitude
LST	Local Solar Time
LV	Launch Vehicle
MAGN	Magnetosphere
MAHII	Mars Hyperspectral Infrared Imager
MALTO	Mission Analysis Low-Thrust Optimization
MARCI	Mars Color Imager
MarCO	Mars Cube One

MARLI	Mars LiDAR
MARSIS	Mars Advanced Radar for Subsurface and Ionosphere Sounding
MaSMI	Magnetically Shielded Miniature
MatISSE	Maturation of Instruments for Solar System Exploration (MatISSE)
MAVEN	Mars Atmosphere and Volatile Evolution
MAVRIC	Mars Atmosphere Volatile and Resource Investigation Camera
MCS	Mars Climate Sounder
MEL	Master Equipment List
MEPAG	Mars Exploration Program Analysis Group
MER	Mars Exploration Rover
MEV	Maximum Expected Value
MGA	Medium Gain Antenna
MGCM	Mars General Circulation Models
MGS	Mars Global Surveyor
MGSE	Mechanical Ground Support Equipment
MGS	Mars Global Surveyor
MLI	Multilayer Insulation
MMX	Martian Moons Explorer
mNLP	Multi-Needle Langmuir Probe
MOC	Mars Orbiter Camera
MOI	Mars Orbit Insertion
MOLA	Mars Orbiter Laser Altimeter
MOS	Mission Operation Systems
MOSAIC	Mars Orbiters for Surface-Atmosphere-Ionosphere Connections
MPB	Magnetic Pileup Boundary
MPV	Max Possible Value
MRO	Mars Reconnaissance Orbiter
MSIA	Multi mission System Interface Assembly
MSL	Mars Science Laboratory
MT	Metric Ton
MTIF	
MUV	Mid-Ultraviolet
N/S	North/South
NAC	Narrow Angle Camera
NASA	National Aeronautics and Space Administration
NE	Northeast
NEX-SAG	Next Orbiter Science Analysis Group
NEXT	NASA Evolutionary Xenon Thruster
NF	New Frontiers
NG	Northrop Grumman
NGIMS	Neutral Gas and Ion Mass Spectrometer
NICM	NASA Instrument Cost Model
NIR	Near Infrared
NPR	NASA Procedural Requirements

NRE	Nonrecurring Engineering
NRL	Naval Research Laboratory
NVMCAM	Non-Volatile Memory/Camera
O	Oxygen
OBP	Onboard Processor
OCTL	Optical Communication Telescope Laboratory
OPALS	Optical Payload for Lasercomm Science
OQ	Observational Quantity
Pa	Pressure
PAD	Pitch Angle Distributions
PAF	Payload Attach Fitting
PBC	Power Bus Controller
PDR	Preliminary Design Review
PI	Principal Investigator
PICASSO	Planetary Instrument Concepts for the Advancement of Solar System Observations
PMCS	Planetary Mission Concept Study
PP	Physical Parameter
PPMV	Part Per Million By Volume
PPO	Planetary Protection Officer
PPU	Power Processing Unit
PREFIRE	Polar Radiant Energy in the Far-InfraRed Experiment
PRT	Platinum Resistance Thermometer
P-SAG	Precursor Strategy Analysis Group
PSAR	P-band Synthetic Aperture Radar
PSE	Project System Engineer
RCS	Reaction Control System
RF	Radio Frequency
RIT	Radio-Frequency Ion Thruster
ROM	Rough Order of Magnitude
ROSA	Roll Out Solar Arrays
RW	Reaction Wheel
RWA	Reaction Wheel Assembly
RX	Receiver (Filter)
RY	Real Year
S/C	Spacecraft
S/W	Software
SAR	Synthetic Aperture Radar
SEER	System Evaluation and Estimate of Resources
SEER-H	System Evaluation and Estimate of Resources-Hardware
SEP	Solar Electric Propulsion
SHARAD	SHallow RADar
SIMPLEx	Small Innovative Missions for Planetary Exploration
SKG	Strategic Knowledge Gap
SNR	Signal-to-Noise Ratio

SOCM	Space Operations Cost Model
SPA	Space
SSCM	Small Satellite Cost Model
SSO	Sun-Synchronous Orbit
STATIC	SupraThermal And Thermal Ion Composition
STM	Science Traceability Matrix
SVIT	System Verification, Integration, and Test
SW	Solar Wind
TBD	To Be Defined
TES	Thermal Emission Spectrometer
TGO	Trace Gas Orbiter
THEMIS	Thermal Emission Imaging System
THEMIS	Time History of Events and Macroscale Interactions during Substorms for Earth Science
THER	Thermosphere
TIR	Thermal Infrared
TMCO	Technical, Management, Cost and Other
TOF	Time-of-Flight
TRL	Technology Readiness Level
TUBS	Technical University of Braunschweig
TWTA	Traveling Wave Tube Amplifiers
TX	Transmitter (Filter)
UARS	Upper Atmosphere Research Satellite
UC	University of California
UHF	Ultrahigh Frequency
USO	Ultra-stable Oscillator
UST	Universal Space Transponder
UV	Ultraviolet
UV-Vis	Ultraviolet/Visible
V&V	Verification and Validation
VERITAS	Venus Emissivity, Radio Science, InSAR, Topography & Spectroscopy
VH	vertical-horizontal
VHPMR	Vapor H ₂ O ₂ Microbial Reduction
VV	vertical-vertical
WA	Wide Angle
WAC	Wide Angle Camera
WBS	Work Breakdown Structure
XFC	Xenon Feed Controller
XIPS	Xenon Ion Propulsion System

Appendix B Science and Design Team Study Report

Appendix B contains supporting material. It is strongly recommended that the reader start with the MOSAIC Science Team Study Report in Appendix B.1. It summarizes the relevance and rationale for MOSAIC, introduces the science definition study team, and defines the science and instrument requirements. To explore the trade space and then examine point designs, MOSAIC went through a series of JPL design team sessions intended to mature the concept. Reports distilled from the design sessions that give further insight into the trade space and point designs are provided in Appendix B.2 to B.5: A Team (Appendix B.2), Team Xc (Appendix B.3), Team X (Appendix B.4), and Team X Follow On (Appendix B.5). These are best accessed via the Table of Contents. Please also note the Preface, which gives general guidelines on Appendix B.

Preface

- Payloads chosen for the Team X studies (Appendix B.3 to B.5) might differ from the ideal payloads envisioned by the MOSAIC science team. These differences are due to availability of necessary information for entrance into Team X as well as the fact that the MOSAIC study team continued to refine the notional payloads after the point design study. It is noted in the text where these differences arise. The payloads described in the Team X documents are intended as a roadmap to MOSAIC science, where other reasonable alternatives exist or are in development.
- A Team X Follow On design study was conducted; it is provided in Appendix B.5. Only the Team X systems report is provided. It should be noted that the analysis and results in this design study are very conservative.
- The nomenclature “ATLO” is used throughout this Appendix B. It is equivalent to NASA’s new nomenclature Assembly Integration and Test (A&IT).
- The main body (Section 1–5) of the MOSAIC final report takes precedence over information in the Appendix where conflicts, omissions, or errors exist.
- All MOSAIC design team activities are listed in time order with brief explanations in Table B-0.
- An overview of studied MOSAIC mission concepts with references the JPL design team session reports are given in Table B-1.

Table B-0. MOSAIC design team activities listed in time order with brief explanations.

Appendix	Design Team Activity	Product
B.1	MOSAIC science team study report	Summary of relevance and rationale for MOSAIC, introduction of science definition study team, and definition of science and instrument requirements
B.2	JPL A Team science and architecture early trade space exploration	Science goals, objectives, measurements, instruments, mission, and spacecraft architectures for CML 3 trade space exploration
B.3	JPL Team Xc	CML 4 point designs for polar, spinning elliptical, and areostationary smallsats to feed into later Team X mothership and constellation CML 4 point designs
B.4	JPL Team X	Mature two point designs for mothership and constellation identified through previous study team work and CML 3 A Team trade space examination. One point design for the reduced payload mothership is in New Frontiers cost bin.
B.5	JPL Team X Follow On	Follow on Team X design study for a “mini mothership”. It describes a possible addition to the constellation carried to Mars or a replenishment option should the Mothership fail. Only the Team X systems report was prepared.

Table B-1. Overview of all studied MOSAIC mission concepts.

Mission Concept (Name in JPL Team Xc, Team X, and Team X Follow On design studies)	Platform (Number of Copies) [Relevant Appendix]	Instruments	Total Number of Instruments on All Copies of Platforms	Total Number of Instruments in Mission Concept
MOSAIC Baseline Constellation (Option 2 encompasses all Constellation elements)	Mothership (1) (see Appendix B.4)	<ul style="list-style-type: none"> • P-band SAR + Sounder • Wide Angle Imager • Thermal IR radiometer (AMCS) • Wind LiDAR (MARLI) • Sub-mm sounder • Near IR spectrometer • Wind doppler interferometer • FUV/MUV spectrograph 	8	49 (22 unique)
	Polar (3) (see Appendix B.3)	<ul style="list-style-type: none"> • TIR radiometer (mini-MCS) • NIR spectrometer 	6	
	Elliptical (2) (see Appendix B.3)	<ul style="list-style-type: none"> • Fluxgate magnetometer • Ion energy/angle/mass • Electron energy/angle • Electric fields • Search coil magnetometer • Langmuir probe 	12	
	Areo Carrier (1) (see Appendix B.3)	<ul style="list-style-type: none"> • Visible camera • TIR radiometer (mini-MCS) • NIR spectrometer • FUV/EUV spectrograph • Fluxgate magnetometer • Ion energy/angle • Electron energy/angle • Energetic ion/electron • Extreme UV monitor 	9	
	Areo SmallSat A (1)	<ul style="list-style-type: none"> • Visible camera • TIR radiometer (mini-MCS) • NIR spectrometer • Fluxgate magnetometer • Ion energy/angle • Electron energy/angle • Energetic ion/electron • Extreme UV monitor 	8	
	Areo SmallSat B (2)	<ul style="list-style-type: none"> • Visible camera • TIR radiometer (mini-MCS) • NIR spectrometer 	6	
MOSAIC Descope 1 Constellation (Option 4 encompasses all Constellation elements)	Mini-Mothership (1) (see Appendix B.4)	<ul style="list-style-type: none"> • P-band SAR + Sounder • Wide Angle Imager • Thermal IR radiometer (AMCS) • Wind LiDAR (MARLI) 	4	45
	Polar (3) (see Appendix B.3)	<ul style="list-style-type: none"> • TIR radiometer (mini-MCS) • NIR spectrometer 	6	
	Elliptical (2) (see Appendix B.3)	<ul style="list-style-type: none"> • Fluxgate magnetometer • Ion energy/angle/mass • Electron energy/angle • Electric fields • Search coil magnetometer • Langmuir probe 	12	
	Areo Carrier (1) (see Appendix B.3)	<ul style="list-style-type: none"> • Visible camera • TIR radiometer (mini-MCS) • NIR spectrometer • FUV/EUV spectrograph 	9	

Table B-1. Overview of all studied MOSAIC mission concepts.

Mission Concept (Name in JPL Team Xc, Team X, and Team X Follow On design studies)	Platform (Number of Copies) [Relevant Appendix]	Instruments	Total Number of Instruments on All Copies of Platforms	Total Number of Instruments in Mission Concept
		<ul style="list-style-type: none"> • Fluxgate magnetometer • Ion energy/angle • Electron energy/angle • Energetic ion/electron • Extreme UV monitor 		
	Areo SmallSat A (1)	<ul style="list-style-type: none"> • Visible camera • TIR radiometer (mini-MCS) • NIR spectrometer • Fluxgate magnetometer • Ion energy/angle • Electron energy/angle • Energetic ion/electron • Extreme UV monitor 	8	
	Areo SmallSat B (2)	<ul style="list-style-type: none"> • Visible camera • TIR radiometer (mini-MCS) • NIR spectrometer 	6	
<p>MOSAIC Mothership Option 1 encompasses only the Mothership Option 5 encompasses only the Mothership (non-Carry) Option 6 encompasses only the Mothership (non-Carry)</p>	<p>Mothership (1) (see Appendix B.4) (see Appendix B.5)</p>	<ul style="list-style-type: none"> • P-band SAR + Sounder • Wide Angle Imager • Thermal IR radiometer (AMCS) • Wind LiDAR (MARLI) • Sub-mm sounder • Near IR spectrometer • Wind doppler interferometer • FUV/MUV spectrograph 	8	8
<p>MOSAIC Mini-Mothership Option 3 encompasses only the Mini-Mothership Option 7 encompasses only the Mini-Mothership (non-Carry)</p>	<p>Mini-Mothership (1) (see Appendix B.4) (see Appendix B.5)</p>	<ul style="list-style-type: none"> • P-band SAR + Sounder • Wide Angle Imager • Thermal IR radiometer (AMCS) • Wind LiDAR (MARLI) 	4	4

Table of Contents

B.1	MOSAIC Science Team Study Report	B-10
B.1.1	Relevance and Rationale for MOSAIC	B-10
B.1.2	Science Definition Study Team and Overview	B-12
B.1.3	Science Requirements Definition.....	B-14
B.1.3.1	Investigation 1: Ice	B-15
B.1.3.2	Investigation 2: Lower-middle Atmosphere Structure	B-16
B.1.3.3	Investigation 3: Lower-middle Atmosphere Diurnal (DIU) Behavior	B-18
B.1.3.4	Investigation 4: Thermosphere (THER).....	B-21
B.1.3.5	Investigation 5: Ionosphere (IONO)	B-22
B.1.3.6	Investigation 6: Exosphere (EXO) and Neutral Escape	B-23
B.1.3.7	Investigation 7: Magnetosphere (MAGN) and Ion Escape	B-24
B.1.3.8	Investigation 8: Space (SPA) Weather.....	B-26
B.1.4	Instrument Requirements Definition.....	B-27
B.1.4.1	Subsurface and Surface Ice	B-28
B.1.4.2	Lower and Middle Atmosphere	B-28
B.1.4.3	Thermosphere.....	B-30
B.1.4.4	Ionosphere	B-31
B.1.4.5	Exosphere.....	B-31
B.1.4.6	Magnetosphere, Ion Escape, Space Weather	B-32
B.1.4.7	Radio Science	B-34
B.1.5	Measurement Requirements Table	B-35
B.1.6	Instrument Requirements Table	B-42
B.1.7	Modularity / Flexibility of MOSAIC	B-48
B.1.7.1	Existing / Planned assets	B-48
B.1.7.2	International or commercial contributions.....	B-49
B.1.7.3	Graceful degradation with asynchronous or reduced capability	B-49
B.1.8	Comparison and synergy of MOSAIC with other missions	B-52
B.2	A Team Science and Architecture Early Trade Space Exploration Design Study Report Summary	B-56
B.3	Team Xc Design Study Report Summary	B-60
B.3.1	Systems	B-60
B.3.1.1	Polar Orbiter SmallSat.....	B-60
B.3.1.2	Spinning Elliptical Orbit SmallSat	B-62
B.3.1.3	Areostationary SEP Spacecraft.....	B-65
B.3.2	Mission Design	B-68
B.3.2.1	Polar Orbit SmallSat	B-68
B.3.3	ACS	B-69
B.3.3.1	Polar Orbit SmallSat	B-69
B.3.3.2	Spinning Elliptical Orbit SmallSat	B-70
B.3.3.3	Areostationary SEP spacecraft.....	B-71
B.3.4	CDH.....	B-72
B.3.5	Propulsion	B-74
B.3.5.1	Polar Orbit SmallSat	B-74
B.3.5.2	Spinning Elliptical Orbit SmallSat	B-75
B.3.5.3	Areostationary SEP spacecraft	B-75
B.3.6	Mechanical.....	B-76
B.3.6.1	Polar Orbit SmallSat	B-76
B.3.6.2	Spinning Elliptical Orbit SmallSat	B-78
B.3.6.3	Areostationary SEP Spacecraft.....	B-79

B.3.7	Telecom	B-80
B.3.7.1	Polar Orbit SmallSat	B-80
B.3.7.2	Spinning Elliptical Orbit SmallSat	B-81
B.3.7.3	Areostationary SEP Spacecraft.....	B-83
B.3.8	Power	B-84
B.3.9	Thermal.....	B-86
B.3.9.1	Polar Orbit SmallSat	B-86
B.3.9.2	Spinning Elliptical Orbit SmallSat	B-87
B.3.9.3	Areostationary SEP spacecraft.....	B-87
B.3.10	GDS	B-88
B.3.11	Planetary Protection.....	B-90
B.3.12	Cost	B-93
B.4	Team X Design Study Report Summary.....	B-101
B.4.1	Executive Summary	B-101
B.4.2	Systems	B-102
B.4.3	Science	B-112
B.4.4	Instruments	B-115
B.4.5	Mission Design	B-119
B.4.6	Configuration.....	B-121
B.4.7	Mechanical.....	B-126
B.4.8	ACS	B-131
B.4.9	Power	B-132
B.4.10	Propulsion	B-137
B.4.11	Thermal.....	B-139
B.4.12	CDS.....	B-142
B.4.13	Telecom	B-144
B.4.14	Ground Systems	B-147
B.4.15	Software.....	B-148
B.4.16	Planetary Protection.....	B-151
B.4.17	SVIT.....	B-154
B.4.18	Cost	B-155
B.5	Team X Follow On Design Study Report Summary.....	B-176

Figures

- Figure B-1. MOSAIC Baseline Constellation. Green boxes represent completed investigations. Black objective text represents fulfilled objectives..... B-50
- Figure B-2. MOSAIC Descope 1 Constellation. Green boxes represent completed investigations, orange boxes are partially completed, and red boxes are not meaningfully completed. Similarly, black objective text represents fulfilled objectives, orange text represents partially-fulfilled objectives, while crossed-out red text represents objectives not addressed at all. B-50
- Figure B-3. MOSAIC Descope 2 Constellation. Green boxes represent completed investigations, orange boxes are partially completed, and red boxes are not meaningfully completed. Similarly, black objective text represents fulfilled objectives, orange text represents partially-fulfilled objectives, while crossed-out red text represents objectives not addressed at all. B-51
- Figure B-4. MOSAIC Descope 3 Constellation. Green boxes represent completed investigations and red boxes are not meaningfully completed. Similarly, black objective text represents fulfilled objectives, orange text represents partially-fulfilled objectives, while crossed-out red text represents objectives not addressed at all. B-51

Figure B-5. MOSAIC Descope 4 Constellation. Green boxes represent completed investigations, orange boxes are partially completed, and red boxes are not meaningfully completed. Similarly, black objective text represents fulfilled objectives, orange text represents partially-fulfilled objectives, while crossed-out red text represents objectives not addressed at all. B-52

Figure B-6. Architectures as listed in Table B-7 evaluated by science objectives. B-58

Figure B-7. Architectures as listed in Table B-7 evaluated by non-science figures of merit. B-58

Figure B-8. Weighted architecture score for architectures listed in Table B-7. B-59

Figure B-9. Five Mothership variants with FY25 cost. Blue color is cost with 50% reserves, green color is cost with 30% reserves. B-59

Figure B-10. Overview of spacecrafts covered in the Team Xc design study. B-60

Figure B-11. Configuration and Instrument Accommodations on Polar SmallSat. B-61

Figure B-12. Selected cylindrical configuration with wraparound solar arrays and axial radio science antennas on each end..... B-63

Figure B-13. Spacecraft Design of Spinning Elliptical SmallSat. B-64

Figure B-14. Configuration constraints during science phase for Areostationary SEP spacecraft. B-65

Figure B-15. Instrument accommodation on Areostationary SEP spacecraft..... B-66

Figure B-16. Polar Orbit SmallSat design (stowed). B-76

Figure B-17. Polar Orbit SmallSat design (deployed)..... B-77

Figure B-18. Spinning Elliptical Orbit SmallSat (stowed)..... B-78

Figure B-19. Spinning Elliptical Orbit SmallSat (deployed). B-78

Figure B-20. Areostationary SEP Spacecraft (stowed)..... B-79

Figure B-21. Areostationary SEP Spacecraft (deployed). B-79

Figure B-22. WBS breakdown for FY25 cost for Areostationary SEP spacecraft with SmallSats for Phases A-F. B-100

Figure B-23. Mothership concept of operations. B-101

Figure B-24. Project Schedule for Phase E provided by MOSAIC study team. B-104

Figure B-25. Design for option 1 & 2 (mothership)..... B-107

Figure B-26. Design for option 3 & 4 (mothership)..... B-108

Figure B-27. Option 1 (stowed)..... B-122

Figure B-28. Option 1 (stowed, in fairing)..... B-122

Figure B-29. Option 1 (deployed). B-123

Figure B-30. Option 1 (deployed). B-123

Figure B-31. Option 1 (boom deployment)..... B-123

Figure B-32. Option 3 (stowed)..... B-124

Figure B-33. Option 3 (stowed, in fairing)..... B-124

Figure B-34. Option 3 (deployed). B-125

Figure B-35. Option 3 (deployed). B-125

Figure B-36. Thermal cost for option 1. B-140

Figure B-37. Thermal cost for option 3. B-141

Tables

Table B-0. MOSAIC design team activities listed in time order with brief explanations.B-1

Table B-1. Overview of all studied MOSAIC mission concepts.B-2

Table B-2. Pre- and (expected) post-MOSAIC understanding of Mars atmospheric system connections. Letters represent current understanding of the effect of the row quantity on the column quantity, from P (poor understanding) to M (mature). Colors represent expected improvement in understanding enabled by MOSAIC: Incremental (orange), Significant (yellow), and Groundbreaking (green). Green boxes containing B and P represent the greatest promised improvements. Note: Characterization of spatial and temporal variability is implied for each of these variables. Text boxes explain why MOSAIC will (or will not in some cases) improve understanding of connections. B-12

Table B-3. MOSAIC Science Definition Team, divided into working groups. B-13

Table B-4. MOSAIC Measurement Requirements. B-35

Table B-5. Performance metrics of instruments considered for the MOSAIC payload. B-42

Table B-6. MOSAIC's investigations can be fulfilled to varying degrees (fully, mostly, significantly, or partially) by existing or planned Mars orbiters. B-48

Table B-7. MOSAIC architectures as discussed in A Team design study, which was a preliminary architecture design assessment. These architectures are not directly correlated to the point designs from Team Xc, Team X, and Team X Follow On. MS = Mothership, Inv = Investigation, Areo = Areostationary, RO = Radio Occultation. B-57

Table B-8. Instrument Accommodation on Spinning Elliptical SmallSat. B-63

Table B-9. Polar Orbit SmallSat cost summary table in FY25. B-68

Table B-10. Spinning Elliptical Orbit SmallSat cost summary table in FY25. B-68

Table B-11. Areostationary carrier spacecraft cost summary table in FY25. B-69

Table B-12. ACS Design for Polar Orbit SmallSat. B-69

Table B-13. ACS Design for Spinning Elliptical Orbit SmallSat. B-70

Table B-14. Areostationary SEP spacecraft components. B-71

Table B-15. Cost breakdown for Areostationary SEP spacecraft. B-89

Table B-16. PP cost summary for option 1 with 3 Polar Orbit SmallSats. B-92

Table B-17. PP cost summary for option 2 with 2 Spinning Elliptical Orbit SmallSats. B-92

Table B-18. PP cost summary for option 3 with 1 Areostationary SEP spacecraft carrying 3 SmallSats. B-92

Table B-19. WBS breakdown for FY25 cost of Polar Orbit SmallSat (1 unit) for Phases A-F. B-94

Table B-20. WBS breakdown for FY25 cost of Polar Orbit SmallSat (3 units) for Phases A-F. B-95

Table B-21. WBS breakdown for FY25 cost of Spinning Elliptical Orbit SmallSat (1 unit) for Phases A-F. B-96

Table B-22. WBS breakdown for FY25 cost of Spinning Elliptical Orbit SmallSat (2 units) for Phases A-F. B-97

Table B-23. WBS breakdown for FY25 cost of Areostationary SEP spacecraft (1 unit) for Phases A-F. B-98

Table B-24. WBS breakdown for FY25 cost for 1 Areostationary SEP spacecraft with SmallSats for Phases A-F. B-99

Table B-25. MOSAIC Team X option comparison. B-102

Table B-26. Power modes for option 1 (Mothership). B-103

Table B-27. Power modes for option 3 (Mothership). B-103

Table B-28. Project schedule for options 1-4. B-105

Table B-29. Systems summary for option 1 & 2 (Mothership). B-109

Table B-30. Systems summary for option 3 & 4 (Mothership). B-110

Table B-31. Data volumes used in Team X design study. B-113

Table B-32. Cost for baseline payload (option 1).	B-114
Table B-33. Cost for reduced payload with 4 instruments (option 3).	B-114
Table B-34. Instrument design option 1 & 2.	B-115
Table B-35. Instrument design option 3 & 4.	B-116
Table B-36. Instrument costs for option 1.	B-117
Table B-37. Instrument costs for option 3.	B-118
Table B-38. Instrument cost option comparison.	B-119
Table B-39. Cost for option 1, Mothership only.	B-119
Table B-40. Cost for option 2, Mothership with constellation.	B-119
Table B-41. Cost for option 3, reduced Mothership.	B-120
Table B-42. Cost for option 4, reduced Mothership with constellation.	B-120
Table B-43. Mission design cost option comparison.	B-120
Table 44. Configuration option comparison.	B-126
Table B-45. Mechanical design, option1.	B-127
Table B-46. Mechanical design option 3.	B-128
Table B-47. Hardware element cost table for option 1.	B-129
Table B-48. WBS breakdown cost for option 1.	B-129
Table B-49. Hardware element cost table for option 3.	B-130
Table B-50. WBS breakdown cost for option 3.	B-130
Table B-51. Mechanical option comparison.	B-131
Table B-51. ACS cost for option 1.	B-132
Table B-52. ACS cost for option3.	B-132
Table B-53. Power summary for option 1.	B-133
Table B-54. Power summary for option 3.	B-134
Table B-55. Power design for solar arrays.	B-135
Table B-56. Cost of power system for option 1.	B-136
Table B-57. Cost of power system for option 3.	B-136
Table B-58. Propulsion cost for option 1.	B-138
Table B-59. Propulsion cost for option 3.	B-138
Table B-60. Option comparison for propulsion cost.	B-139
Table B-61. Thermal cost option comparison.	B-141
Table B-62. CDS cost option 1.	B-143
Table B-63. CDS cost option 3.	B-143
Table B-64. Downlink data rates at K-band for both options.	B-145
Table B-65. Telecom cost for option 1.	B-146
Table B-66. Telecom cost for option 3.	B-146
Table B-67. Ground system cost.	B-147
Table B-68. Software cost for option 1.	B-150
Table B-69. Software cost for option 3.	B-151
Table B-70. Planetary protection cost for option 1 & 3.	B-153
Table B-71. Option 1 cost for V&V.	B-154
Table B-72. Option 2 cost for V&V.	B-154
Table B-73. Option 3 cost for V&V.	B-154

Table B-74. Option 4 cost for V&V.....	B-154
Table B-75. Total cost for option 1.....	B-157
Table B-76. Total cost for option 2.....	B-157
Table B-77. Total cost for option 3.....	B-158
Table B-78. Total cost for option 4.....	B-158
Table B-79. Cost A–D for option 1 (50% reserve).....	B-160
Table B-80. Cost A–D for option 1 (30% reserve).....	B-160
Table B-81. Cost E–F for option 1 (25% reserve).....	B-161
Table B-82. Cost E–F for option 1 (15% reserve).....	B-162
Table B-83. Cost A–D for option 2 (50% reserve).....	B-163
Table B-84. Cost A–D for option 2 (25% reserve).....	B-164
Table B-85. Cost E–F for option 2 (25% reserve).....	B-165
Table B-86. Cost E–F for option 2 (15% reserve).....	B-166
Table B-87. Cost A–D for option 3 (50% reserve).....	B-167
Table B-88. Cost A–D for option 3 (30% reserve).....	B-168
Table B-89. Cost E–F for option 3 (25% reserve).....	B-168
Table B-90. Cost E–F for option 3 (15% reserve).....	B-169
Table B-91. Cost A–D for option 4 (50% reserve).....	B-170
Table B-92. Cost A–D for option 4 (30% reserve).....	B-171
Table B-93. Cost E–F for option 4 (25% reserve).....	B-172
Table B-94. Cost E–F for option 4 (15% reserve).....	B-173
Table B-95. Cost option comparison with 50% reserve.....	B-175
Table B-96. Cost option comparison with 30% reserve.....	B-176

B.1 MOSAIC Science Team Study Report

B.1.1 Relevance and Rationale for MOSAIC

Relevance to NASA. By advancing our understanding of the physical processes governing flows of matter and energy within and between Mars’s atmospheric regions, MOSAIC’s goals and objectives directly address the 2014 NASA Science Plan, which states that NASA will “advance the understanding of how the chemical and physical processes in our solar system operate, interact and evolve”.

Relevance to Mars Exploration Program Analysis Group (MEPAG). MOSAIC addresses key Mars Exploration Program objectives, as described in the MEPAG Goals Document (Banfield et al. 2020) under several goals, primarily Goals II and IV, relating to climate and human exploration, respectively.

Goal II “Understand the processes and history of climate on Mars”

- A1. Constrain the processes that control the present distributions of dust, water, and carbon dioxide in the lower atmosphere, at daily, seasonal, and multi-annual timescales.
- A2. Constrain the processes that control the dynamics and thermal structure of the upper atmosphere and surrounding plasma environment.
- A4. Constrain the processes by which volatiles and dust exchange between surface and atmospheric reservoirs.
- C3. Determine present escape rates of key species and constrain the processes that control them.

Goal IV “Prepare for Human Exploration”

- A1. Determine the aspects of the atmospheric state that affect orbital capture and EDL for human scale missions to Mars.
- B3. Assess the climatological risk of dust storm activity in the human exploration zone at least one year in advance of landing and operations.
- C2. Characterize potentially extractable water resources to support ISRU for long-term human needs.

In addition, in characterizing the depth profile of near-subsurface and surface ice, as well as lower atmospheric temperatures and winds, MOSAIC’s measurements are also relevant to Goals I and III.

Goal I “Determine if Mars ever supported, or still supports, life.”

- B2. Constrain the surface, atmosphere, and subsurface processes through which organic molecules could have formed and evolved over Martian history.

Goal III “Understand the origin and evolution of Mars as a geological system.”

- A1. Identify and characterize past and present water and other volatile reservoirs.

In addition, the recently-completed report from the MEPAG ICE-SAG identified a weather-dedicated Mars orbiter(s) as a top priority for future study (Diniega and Putzig 2019).

Relevance to 2013-2022 Decadal Survey. The most recent Decadal Survey (Council 2011) specifically calls for a mission like MOSAIC, stating: “Fundamental advances in our understanding of modern climate would come from a complete determination of the three-dimensional structure of the Martian atmosphere from the surface boundary layer to the exosphere. This should be performed globally, ideally by combining wind, surface pressure and accurate temperature measurements from landed and orbital payloads.”

Relevance to NASA Exploration. MOSAIC would fulfill seven high-priority Strategic Knowledge GFAs to enable human exploration, as identified by P-SAG (Beaty et al. 2012). Investigation 1 fulfills D1-5 and D1-6 (subsurface ice), Investigations 2 and 3 address A1-1 (global temperature field), A1-2 (global aerosol profiles), A1-3 (global wind profiles), and B1-1 (dust climatology). Investigation 4 completes A1-1 and A1-3, but for the upper atmosphere. Investigation 9 addresses A4-2 (optical communication). Though not expressly identified as a Strategic Knowledge Gap (SKG), MOSAIC’s

areostationary platforms and use of Delay Tolerant Networking provides nearly continuous relay communications between the surface, orbit, and Earth, presumably a strong desire for future landed human missions.

Concept maturity/relationship to SAGs. While the types of needed measurements in the lower- and middle atmosphere are well-understood and mostly outlined by Next Orbiter Science Analysis Group. (NEX-SAG) (Campbell et al. 2015) and ICE-SAG (Diniega and Putzig 2019), these studies did not take account of recent work that suggests strong relationships between lower/middle atmospheric dynamics and escape from the upper atmosphere (Chaffin et al. 2017, Heavens et al. 2018, Jakosky et al. 2018, Bhattacharyya et al. 2017) and extreme weather in mesoscale systems (Heavens et al. 2015, Spiga et al. 2017, Hayne et al. 2014). In addition, this kind of concept is technically very immature at present. A PMCS study is needed to understand the risks and technical challenges of flying and operating a mothership with several linked daughtercrafts in the Mars environment; as well as to specify the resolution and sampling frequency necessary to understand extreme weather at sub-100 km scales.

Rationale for MOSAIC. To “demonstrate the relationship of the proposed science investigation to the present state of knowledge in the field” (language from the PMCS AO), Table B-2 provides an assessment of the scientific usefulness compared to the current state of knowledge of each of the proposed measurements, in understanding the interconnections of the Martian atmosphere system. As can be seen, significant and sometimes large gaps in understanding still exist, with several important quantities having never been systematically measured before (e.g., shallow subsurface ice, winds in the lower and upper atmospheres, spatio-temporal dust dynamics, global structure of the ionosphere, spatio-temporal plasma dynamics, and real-time response to heliospheric disturbances).

Table B-2. Pre- and (expected) post-MOSAIC understanding of Mars atmospheric system connections. Letters represent current understanding of the effect of the row quantity on the column quantity, from P (poor understanding) to M (mature). Colors represent expected improvement in understanding enabled by MOSAIC: Incremental (orange), Significant (yellow), and Groundbreaking (green). Green boxes containing B and P represent the greatest promised improvements. Note: Characterization of spatial and temporal variability is implied for each of these variables. Text boxes explain why MOSAIC will (or will not in some cases) improve understanding of connections.

Characterizing the effect of ↓ on → :		Ice		Lower Atmosphere Structure				Thermosphere			Ionosphere			Exosphere		Magnetosphere		Space Weather Drivers					
MOSAIC will enable, w.r.t. current/planned observations:		Characterized Alone?	Shallow Subsurface	Surface	Temp., Pressure	Dust	H ₂ O (g)/Condensates	Wind	Temp., Pressure	Composition	Wind/Dynamics	Temp., Density	Composition	Dynamics	Structure	Dynamics	E, B Fields	Flows and Ion Escape	Solar Wind	IMF	Solar EUV	Energetic Particles	
Groundbreaking Improvement																							
Significant Improvement																							
Incremental Improvement																							
Ice	Shallow Subsurface	B		B	P	P	B		First systematic observations of shallow subsurface material properties														
	Surface	I	B		B	B	I	P															
Lower Atmosphere	Temp., Pressure	I	B	I		I	I	B	B	B	P	B	B	P	B	B	P	P					First systematic lower atmosphere wind measurements
	Dust	I	P	D	I		D	P	D	D	P	D	D	P	D	D	P	P					
	H ₂ O/Condensates	B	P	B	I	I		P	B	B	P	B	B	P	B	B	P	P					
	Wind/Dynamics	P		P	P	P	P		P	P	P	P	P	P	P	P	P	P					
Thermosphere	Temp., Pressure	I								I	P	I	I	P	I	I	B	B					High-res observations of aerosols and water vapor
	Composition	I								I		P	I	I	P	I	I	B	B				
	Wind/Dynamics	P							P	P		P	P	P	P	P	P	P					First systematic thermosphere wind measurements
Ionosphere	Temp., Density	I										P		B	B	B	B	B	B				Total ionospheric density only
	Composition	I										P	I		B	B	B	B	B				
	Dynamics	B							B		P	B	B		B	B	B	B					
Exosphere	Structure	I												I	I	B		B	B	B			
	Dynamics/Escape	B												B	B	B	B		B	B			
Magnetosphere	E, B Fields	I									B	B	P	B	B	B	B		B				
	Flows and Ion Escape	I									B	B	P	B	B	B	B	B		B			
Space Weather Drivers	Solar Wind	M									B	B	P	B	B	B	B	B	B				
	IMF	M									B	B	P	B	B	B	B	B	B				
	Solar EUV	M									I	I	P	I	I	P	I	B	B	B			
	Energetic Particles	M					P				B	B	P	B	B	P							

Current degree of understanding enabled by available measurements: (M) Mature: Mostly well-understood; (I) Incomplete: At least one important aspect not understood; (B) Basic understanding but many issues remain; (P) Poor understanding and/or based solely on models; Negligible direct connection expected.

B.1.2 Science Definition Study Team and Overview

The MOSAIC science definition study took place from October 2019 until February 2020 and consisted of two main, connected efforts: a) Science measurement requirements definition and b) Instrument requirements definition. Due to the broad, multidisciplinary nature of the MOSAIC science purview, these efforts were conducted by seven different science working groups, as shown in the Table B-3.

Table B-3. MOSAIC Science Definition Team, divided into working groups.

Principal Investigator	Robert Lillis	SSL, UC Berkeley
Deputy PI	David Mitchell	SSL, UC Berkeley
Interdisciplinary Science	Bruce Jakosky	LASP, University of Colorado
Subsurface & Surface Ice		
Lead	Tanya Harrison	Planet Federal Inc.
Co-lead	Cassie Stuurman	NASA Jet Propulsion Laboratory, California Institute of Technology
Member	Isaac Smith Gordon Osinski Catherine Neish	PSI/University of York University of Western Ontario (U. Western Ontario) University of Western Ontario (U. Western Ontario)
Lower & Middle Atmosphere		
Co-lead	Scott Guzewich	NASA Goddard
Co-lead	Luca Montabone	Space Science Institute
Members	Nick Heavens Armin Kleinbohl Leslie Tamppari Michael Mischna Michael Smith Michael Wolff Melinda Kahre Aymeric Spiga François Forget Bruce Cantor David Kass	Space Science Institute NASA Jet Propulsion Laboratory, California Institute of Technology NASA Jet Propulsion Laboratory, California Institute of Technology NASA Jet Propulsion Laboratory, California Institute of Technology NASA Goddard Space Science Institute NASA Ames LMD, Paris LMD, Paris Malin Space Science Systems NASA Jet Propulsion Laboratory, California Institute of Technology
Thermosphere		
Lead	Scott England	Virginia Tech
Members	Justin Deighan Amanda Brecht Steve Bougher	LASP, University of Colorado NASA Ames University of Michigan
Ionosphere		
Lead	Paul Withers	Boston University
Members	Robert Lillis Christopher Fowler David Andrews Martin Patzold Kerstin Peter Silvia Tellman Mark Lester Beatriz Sánchez-Cano	SSL, UC Berkeley SSL, UC Berkeley IRF Uppdala, Sweden University of Koln University of Koln University of Koln University of Leicester University of Leicester
Exosphere & Neutral Escape		
Lead	Michael Chaffin	LASP, University of Colorado
Co-lead	Justin Deighan	LASP, University of Colorado
Magnetosphere, Ion Escape, and Space Weather		
Lead	Shannon Curry	SSL, UC Berkeley
Co-lead	David Mitchell	SSL, UC Berkeley
Members	Janet Luhmann Robert Lillis François Leblanc Jasper Halekas David Brain Xiaohua Fang Jared Espley Hermann Opgenoorth Oleg Vaisberg	SSL, UC Berkeley SSL, UC Berkeley LATMOS, Paris, France University of Iowa LASP, University of Colorado LASP, University of Colorado NASA Goddard University of Umea, Sweden IKI, Moscow, Russia
Radio Science		
Lead	Chi Ao	NASA Jet Propulsion Laboratory, California Institute of Technology
Members	Sami Asmar Josh Vander Hook David Hinson Paul Withers Ozgur Karatekin	NASA Jet Propulsion Laboratory, California Institute of Technology NASA Jet Propulsion Laboratory, California Institute of Technology SETI Institute Boston University Royal Observatory of Belgium

These definition efforts mostly took place over email and biweekly teleconferences within each group, and by a Steering Committee consisting of the Principal Investigator (PI), Deputy PI, and group leads. The efforts culminated in a 2-day Science Definition Team meeting at the UC Berkeley Space Sciences Laboratory on January 27–28, 2020, where the measurement and instrument requirements were discussed and solidified. These requirements were captured in the form of spreadsheets and quad charts that were provided to the design study team at JPL.

B.1.3 Science Requirements Definition

Each of the Science Working Groups mentioned above consisted of recognized experts in their respective subfields. Following the descriptions of each of the MOSAIC investigations, they compiled detailed requirements for each measurement, divided up into the eight MOSAIC investigations. Each measurement was assigned the following attributes (not all are applicable to all measurements):

- ID #
- Explanation of link to MOSAIC objectives
- Physical Parameter (PP) of the Mars system to be measured or estimated
 - PP name (e.g., dust opacity, temperature, ion flux etc.)
 - PP units
 - Expected PP range
 - Coordinate system (e.g., IAU Mars, Mars-Solar-Orbital etc.)
 - Required measurement range and resolution in altitude, latitude, and longitude
 - Required measurement cadence
 - Required seasonal resolution (how many times per season must it be measured?)
- Observational Quantity (OQ) to be directly measured (for in situ instruments, e.g., magnetometers and particle analyzers, this is identical to the physical parameter)
 - OQ name (e.g., intensity of radar power, thermal IR radiance, etc.)
 - OQ units
 - OQ dynamic range
 - Precision
 - Signal-to-noise ratio
 - Measurement cadence
 - Angular FOV: range and resolution in both polar (Y) and azimuth (X) angles
 - Required range and resolution of energy/wavelength/frequency of quantity being measured (e.g., particle energy, photon wavelength, radar frequency, etc.)
 - Mass range (for instruments that measure particle mass).
- Instruments capable of making the measurement

The complete compilation of measurement requirements is contained in Table B-4 in Appendix B.1.5. In the following subsections, we discuss narratively the measurement requirements for each of the investigations.

B.1.3.1 Investigation 1: Ice

“Determine the three-dimensional distribution of ice from the surface to 10 m below and its seasonal variability.”

ICE-1

Measurement requirement ICE-1 requires using the surface polarimetric backscatter to determine surface geologic composition. The expected variation in polarimetric return spans the electrical properties of the target materials, from basaltic rock to clean water ice. The data products are a set of polarimetric SAR images containing information on returned power (in decibels) and phase for each polarimetric return: horizontal-horizontal (HH), horizontal-vertical (HV), vertical-horizontal (VH), and vertical-vertical (VV). There are two measurement modes required: a high-rate mode for regions of interest (30–60° latitude, at all longitudes) at 30-m resolution, and a low-rate mode for other regions at 100-m resolution. The radar will detect surface returns of –29.6 dB or greater. The expected signal-to-noise ratio for the processed data is 8.7–9.1 depending on the location of the target in the scene. The threshold measurement will be a seasonal low-rate mosaic from 30° poleward in each hemisphere; the baseline would include beyond that a full high-rate mosaic twice per Mars year for the latitudes covered by the seasonal polar caps: 50° poleward at the beginning of spring and 80° poleward in mid-summer to capture the maximum and minimum visible extent of each seasonal cap. High-rate non-polar measurements at key areas of interest (e.g., the ice-bearing scalloped terrain of Utopia Planitia) would be acquired as needed. This measurement requirement is consistent with MOSAIC Objectives (Obj.) I.A.–II.A, and is essential for monitoring of surface changes due to volatile exchange with the atmosphere and for the characterization of potentially extractable water ice resources.

ICE-2

Measurement requirement ICE-2 requires detecting near-surface ice via measuring the subsurface moisture content and dielectric permittivity. There is an expected range in dielectric permittivity of 1-20 for Martian materials, depending on the geologic composition of the subsurface. The fully polarimetric SAR will measure the returned power in the channels HH, HV, VH, and VV, which can then be used to calculate the bulk (i.e., not stratified) dielectric permittivity of the subsurface in the 0-3 m range. The horizontal resolution, cadence, and coverage requirements of the polarimetric SAR dielectric permittivity measurements are the same as ICE-1 in all cases as it is simply a different data product from the same instrument.

The sounder will be used to determine the returned power (in decibels) of the subsurface in the 1-15 m range, as the nearest-surface section will be obscured by surface scattering. This returned power can then be used to calculate the dielectric permittivity at depth. The vertical resolution for the sounder measurements is 1.5 m in free space corresponding to a 0.85-m resolution in clean water ice. The maximum expected signal-to-noise ratio for the raw data is 36.9 dB, but this decreases as the signal attenuates with depth. The threshold coverage requirement is a track density of 10 measurements per degree longitude between 30°–60° latitude in both hemispheres over one Mars year. There is no minimum threshold coverage requirement equatorward of 30° latitude. Significant seasonal variations in the ice content of the Martian subsurface are not expected, and thus there are no seasonal repeat requirements for the dielectric permittivity measurements. This measurement requirement is consistent with MOSAIC Objectives I.A.–II.A, and is essential for monitoring of surface changes due to volatile exchange with the atmosphere and for the characterization of potentially extractable water ice resources.

ICE-3

Measurement requirement ICE-3 requires mapping the surface ice distribution over time. Changes in the seasonal components of the northern and southern polar caps have been well-documented by the Mars Global Surveyor wide angle Mars Orbiter Camera (MOC wide angle (WA); 7.5 km resolution) and the MRO MARCI (1–10 km resolution). Active interannual changes have also been observed in

the residual south polar layered deposits. Documenting these changes over time will help us to understand the exchange of ice between the surface and the atmosphere and continue the long-standing record of observations from MOC WA and MARCI. This requires a visible imager of comparable resolution that can cover large swaths of the planet; therefore, the measurement requirements are a 1 km imager with daily near-global daytime coverage and visible-wavelength filters consistent with MARCI (400–750 nm). A 150° FOV allows for meeting this coverage requirement in 14 terminator-to-terminator images. This measurement requirement is consistent with MOSAIC Objectives I.A.–II.A, and is essential for monitoring of surface changes due to volatile exchange with the atmosphere and for the characterization of potentially extractable water ice resources.

B.1.3.2 Investigation 2: Lower -middle Atmosphere Structure

“Measure the geographic and altitude distribution of pressure, winds, aerosol concentrations, water vapor, and temperature in the Mars lower and middle atmosphere, and their variability geographically, diurnally, and seasonally.”

ATM-1 through ATM-4

Measurement requirements ATM-1 through ATM-4 require the measurement of atmospheric temperature (K) and pressure (Pa) from the surface to 80 km altitude over the full range of the Mars seasonal cycle and at local times near 2–3 a.m./p.m. at a vertical resolution of up to 2 km, a horizontal resolution of ~60 km (1 degree of latitude), a precision in temperature of 1 K and in pressure of up to 0.5%. These measurements are to be done in such a way to allow validation/comparison of MOSAIC measurements against/with long-term climatologies of temperature and pressure at Mars as well as between MOSAIC measurements that use techniques sensitive or insensitive to aerosol opacity (to enable sensing in the aphelion cloud belt, polar hood, and dust storm conditions).

These measurement requirements are consistent with MOSAIC Objectives I.B.–I.C.1.–II.B, because they are essential for monitoring the atmospheric state and the collecting of/comparing with long-term climatologies. They can be executed by a mixture of techniques with substantial history at Mars, such as radio occultation and thermal infrared spectrometric/radiometric sounding but new techniques such as sub-mm sounding would be necessary to fully satisfy the coverage, resolution, and validation criteria of the measurement requirements simultaneously.

ATM-5

Measurement requirement ATM-5 requires the measurement of the vertical profiles of zonal and meridional wind velocity (m/s) at a precision of 5 m/s from the surface to 80 km altitude over the full range of the Mars seasonal cycle and at local times near 2–3 a.m./p.m. at a vertical resolution of ≤ 10 km and a horizontal resolution of ≤ 300 km (5 degrees of latitude).

This measurement requirement is consistent with MOSAIC Objectives I.B.–I.C.1.–II.B, because they are novel and direct measurements of the atmospheric circulation. They can be executed by techniques never implemented before at Mars, such as sub-mm sounding and Doppler shift measurements of lidar returns. The use of both techniques would be necessary to meet the vertical range criterion of the measurement requirement.

ATM-6 through ATM-8

Measurement requirements ATM-6 through ATM-8 require the measurement of the vertical profiles of dust, water ice, and carbon dioxide ice opacity (km^{-1}) over a dynamic range of opacity equivalent to 10^{-6} – 10^{-1} km^{-1} at 1064 nm wavelength at a precision of up to 1% from the surface to 80 km altitude over the full range of the Mars seasonal cycle and at local times near 2–3 a.m./p.m. at a vertical resolution of < 5 km and a horizontal resolution of ~60 km. These measurements are to be done in

such a way to allow validation/comparison of MOSAIC measurements against/with long-term climatologies of aerosol opacity at Mars.

These measurement requirements are consistent with MOSAIC Objectives I.A.–I.B.–I.C.1.–II.B, because they are essential for monitoring the atmospheric state; meteorology and climatology of dust, water, and CO₂ (including exchange with the polar caps); and collecting/comparing with long-term climatologies. They are most completely achieved by measuring atmospheric absorption and backscatter in lidar observations but must be supplemented by techniques with substantial history at Mars, such as near-infrared or thermal infrared passive remote sensing to fully satisfy the coverage, resolution, and validation criteria of the measurement requirements.

ATM-9

Measurement requirement ATM-9 requires the measurement of the vertical profile of water vapor ppmv (part per million by volume) over a dynamic range of 0–2000 ppmv at a precision of 10 ppmv from the surface to 80 km altitude over the full range of the Mars seasonal cycle and at local times near 2–3 a.m./p.m. at a vertical resolution of < 5 km and a horizontal resolution of ~60 km.

This measurement requirement is consistent with MOSAIC Objectives I.A.–I.B.–I.C.1.–II.B, because water vapor profiling is essential for monitoring the water cycle but has never been collected at comparable measurement density as temperature and water ice opacity. Measuring water vapor profiles at similar resolution and coverage to temperature and water ice opacity allows the thermodynamics of atmospheric water to be fully constrained and kinetic effects to be isolated. In conjunction with wind measurements, the transport of water around the planet can be directly calculated. These measurements can be done by thermal infrared or near-infrared spectroscopy/radiometry, and/or sub-mm sounding.

ATM-10

Measurement requirement ATM-10 requires the measurement of surface temperature (K) at a precision of 1 K over the full range of the Mars seasonal cycle and at local times near 2–3 a.m./p.m. at a horizontal resolution of 1 km. These measurements are to be done in such a way to allow validation/comparison of MOSAIC measurements against/with long-term climatologies of surface temperature at Mars.

This measurement requirement is consistent with MOSAIC Objectives I.A.–I.B.–I.C.1.–II.B. These measurements are essential for monitoring of the atmospheric state, validating lower resolution observations from areostationary orbit, and collection of/comparison with long-term climatologies. They also can be used to measure the thermophysical properties of the subsurface within ~1 m of the surface, enabling the detection of shallow ice resources. These measurements can be done with a thermal infrared or microwave spectrometer/radiometer, though using microwave radiometry would be ideal to enable coverage in all conditions, particularly dust storms, while thermal infrared measurements would enable cross-validation with long-term climatologies.

ATM-11

Measurement requirement ATM-11 requires the measurement of surface Pa at a precision of 5% over the full range of the Mars seasonal cycle and at local times near 2–3 p.m. at a horizontal resolution of 2 km.

This measurement requirement is consistent with MOSAIC Objectives I.B.–I.C.1.–II.B. These measurements are essential for monitoring of the atmospheric state and supporting/validating all vertical profile measurements. Surface pressure measurements can be done with a near-infrared spectrometer when the surface is illuminated.

B.1.3.3 Investigation 3: Lower-middle Atmosphere Diurnal (DIU) Behavior

“Measure the complete diurnal and geographic behavior of the atmosphere and evolution of Martian dust and ice clouds, and its seasonal variability.”

DIU-1 through DIU-2

Measurement requirements DIU-1 through DIU-2 require the measurement of the extent and duration of dust and ice clouds from 80°S–80°N at a spatial resolution of < 5 km and temporal resolution of 30 minutes during the daytime across the Mars seasonal cycle and in as many large dust events as possible.

These measurement requirements are consistent with MOSAIC Objectives I.A.–I.B.–I.C.1.–II.B., because they are essential for accurate counting of dust storms and the direct visual monitoring of the evolution of dust storms/water ice clouds/CO₂ clouds. These measurement requirements can be accomplished by UV or visible imaging by appropriate orbital platforms.

DIU-3

Measurement requirement DIU-3 requires the measurement of atmospheric temperature (K) from the surface to 40 km altitude at 10 km vertical resolution from 60°S–60°N at a spatial resolution of < 60 km and temporal resolution of 30 minutes throughout the course of a Mars day across the Mars seasonal cycle and in as many large dust events as possible.

This measurement requirement is consistent with MOSAIC Objectives I.A.–I.B.–I.C.1.–II.B., because this measurement is essential for monitoring of the atmospheric state synchronously with the DIU-1, DIU-2 or the ATM measurements and comparison with long-term climatologies of atmospheric temperature (particularly MGS-TES). This measurement requirement can be accomplished by a thermal infrared radiometer on an appropriate orbital platform.

DIU-4 through DIU-5

Measurement requirements DIU-4 through DIU-5 require the measurement of the column opacities of dust and water ice at 10–20% precision over a dynamic range of 0–5 (optical depth), referenced to a wavelength of 1064 nm, from 60°S–60°N at a spatial resolution of < 60 km and temporal resolution of 30 minutes at most local times across the Mars seasonal cycle and in as many large dust events as possible.

These measurement requirements are consistent with MOSAIC Objectives I.A.–I.B.–I.C.1.–II.B., because these measurements are essential for monitoring of the atmospheric state synchronously with the DIU-1, DIU-2 or the ATM measurements and comparison with long-term climatologies of atmospheric column opacity. This measurement requirement can be accomplished by near-infrared and thermal infrared spectrometers on an appropriate orbital platform.

DIU-6

Measurement requirement DIU-6 requires the measurement of the column opacity of CO₂ ice at 10–20% precision over a dynamic range of 0–5 (optical depth), referenced to a wavelength of 1064 nm, from 60°S–60°N at a spatial resolution of < 60 km and temporal resolution of 30 minutes throughout the course of a Mars day across the Mars seasonal cycle.

This measurement requirement is consistent with MOSAIC Objectives I.A.–I.B.–I.C.1.–II.B., because this measurement is desirable for monitoring of the atmospheric state synchronously with the DIU-1, DIU-2 or the ATM measurements and comparison with long-term climatologies of atmospheric column opacity. It is not essential, because most polar CO₂ ice cloud activity is expected to be poleward of 60°. This measurement requirement can be accomplished by a thermal infrared spectrometer on an appropriate orbital platform.

DIU-7

Measurement requirement DIU-7 requires the measurement of surface Pa at 5–10 Pa precision over a dynamic range of 150–1500 Pa from 60°S–60°N at a spatial resolution of < 60 km and temporal resolution of 30 minutes throughout the course of a Mars day across the Mars seasonal cycle.

This measurement requirement is consistent with MOSAIC Objectives I.A.–I.B.–I.C.1.–II.B., because this measurement is desirable for monitoring of the atmospheric state synchronously with the DIU-1, DIU-2 or the ATM measurements and comparison with long-term climatologies of atmospheric column opacity. It is not essential, because the necessary precision may be difficult to achieve in high dust conditions, when it would be most interesting to compare with aerosol cloud imagery. This measurement requirement can be accomplished by a near-infrared spectrometer on an appropriate orbital platform.

DIU-8

Measurement requirement DIU-8 requires the measurement of column water vapor (pr. μm) at 10–20% precision over a dynamic range of 5–400 pr. μm from 60°S–60°N at a spatial resolution of < 60 km and temporal resolution of 30 minutes throughout the course of a Mars day across the Mars seasonal cycle.

This measurement requirement is consistent with MOSAIC Objectives I.A.–I.B.–I.C.1.–II.B., because this measurement is desirable for monitoring of the atmospheric state synchronously with the DIU-1, DIU-2 or the ATM measurements and comparison with long-term climatologies of atmospheric column opacity. It is not essential, because the necessary precision may be difficult to achieve in high dust conditions, when it would be most interesting to compare with aerosol cloud imagery. This measurement requirement can be accomplished by a near-infrared spectrometer on an appropriate orbital platform.

DIU-9

Measurement requirement DIU-9 requires the measurement of the vertical profile of atmospheric temperature (K) and Pa from the surface to 80 km altitude over the full range of the Mars seasonal cycle and at as many local times other than 2–3 a.m./p.m. as possible at a vertical resolution of up to 2 km, a horizontal resolution of 60–120 km, a precision in temperature of 1 K and in pressure of up to 0.5% over 85°S–85°N. These measurements are to be done in such a way to allow validation/comparison of MOSAIC measurements against/with long-term climatologies of temperature and pressure at Mars.

These measurement requirements are consistent with MOSAIC Objectives I.B.–I.C.1.–II.B, because they are essential for monitoring the atmospheric state, the collecting of/comparing with long-term climatologies, and comparing with imagery, low vertical resolution temperature, and column measurements made under DIU-1 to DIU-9. They can be executed by a mixture of techniques with substantial history at Mars, such as radio occultation and thermal infrared spectrometric/radiometric sounding on appropriate orbital platforms.

DIU-10 through DIU-12

Measurement requirements DIU-10 through DIU-12 require the measurement of the vertical profiles of dust, water ice, and carbon dioxide opacity (km^{-1}) over a dynamic range of 10^{-6} – $2 \times 10^{-2} \text{ km}^{-1}$ at 660 nm at a precision of 10–20% over 85°S–85°N from the surface to 80 km altitude over the full range of the Mars seasonal cycle and as many local times other than 2–3 a.m./p.m. as possible at a vertical resolution of 5 km and a horizontal resolution of 60–120 km. These measurements are to be done in such a way to allow validation/comparison of MOSAIC measurements against/with long-term climatologies of aerosol opacity at Mars

These measurement requirements are consistent with MOSAIC Objectives I.A.–I.B.–I.C.1.–II.B, because they are essential for monitoring the atmospheric state; meteorology and climatology of dust, water, and CO₂ (including exchange with the polar caps); and collecting/comparing with long-term

climatologies, and comparing with imagery, low vertical resolution temperature, and column measurements made under DIU-1 to DIU-9. These measurements can be executed by thermal infrared spectrometric/radiometric sounding on appropriate orbital platforms.

DIU-13

Measurement requirement DIU-13 requires the measurement of the vertical profile of water vapor (ppmv) over a dynamic range of 0–2000 ppmv at a precision of 10 ppmv over 85°S–85°N from the surface to 80 km altitude over the full range of the Mars seasonal cycle and at as many local times other than 2–3 a.m./p.m. as possible at a vertical resolution of 5 km and a horizontal resolution of 60–120 km.

This measurement requirement is consistent with MOSAIC Objectives I.A.–I.B.–I.C.1.–II.B, because they are essential for monitoring the water cycle but have never been collected at comparable measurement density as temperature and water ice opacity. Measuring water vapor profiles at similar resolution and coverage to temperature and water ice opacity allows the thermodynamics of atmospheric water to be fully constrained and kinetic effects to be isolated. Comparing with imagery, low vertical resolution temperature, and column measurements made under DIU-1 to DIU-9 would allow the relative roles of water vapor availability, temperature, and condensation nuclei availability (i.e., dust) in cloud formation and evolution to be studied. These measurements can be done by thermal infrared spectroscopy/radiometry on appropriate orbital platforms.

DIU-14

Measurement requirement DIU-14 requires the measurement of surface temperature (K) at a precision of 1 K over 85°S–85°N over the full range of the Mars seasonal cycle and at as many local times other than 2–3 a.m./p.m. as possible at a horizontal resolution of 1 km.

This measurement requirement is consistent with MOSAIC Objectives I.A.–I.B.–I.C.1.–II.B. These measurements are essential for monitoring the atmospheric state, validating lower resolution observations from areostationary orbit, and collection of/comparison with long-term climatologies. They also can be used to measure the thermophysical properties of the subsurface within ~1 m of the surface, enabling the detection of shallow ice resources. These measurements can be done by thermal infrared spectroscopy/radiometry on appropriate orbital platforms.

DIU-15

Measurement requirement DIU-15 requires the measurement of zonal and meridional winds (m/s) at a precision of < 10 m/s wherever there are aerosol clouds or other features to be tracked.

This measurement requirement is consistent with MOSAIC Objectives I.A.–I.B.–I.C.1.–II.B. These measurements are essential for direct visual monitoring of the evolution of dust storms/water ice clouds/CO₂ cloud evolution. They can also be used to reconstruct much of the global wind field, particularly its tidal component, at whatever level clouds are present. Imagery or image-like measurements with features trackable from measurement to measurement every 30 minutes are optimal to fulfill this measurement requirement.

DIU-16

Measurement requirement DIU-16 requires the measurement of surface Pa at a precision of 5% over the full range of the Mars seasonal cycle and at as many local times other than 2–3 a.m./p.m. as possible at a horizontal resolution of 2 km.

This measurement requirement is consistent with MOSAIC Objectives I.B.–I.C.1.–II.B. These measurements are desirable for monitoring of the atmospheric state and supporting/validating all vertical profile/column measurements. Comparing with imagery and low vertical resolution temperature measurements under relevant DIU investigations can be used to understand meteorological dynamics of synoptic systems and pressure tides. Surface pressure measurements can be done with a near-infrared spectrometer on an appropriate orbital platform when the surface is illuminated.

B.1.3.4 Investigation 4: Thermosphere (THER)

“Measure the global 3-D composition, structure, and winds in Mars’s thermosphere, and its variability with season and solar activity.”

The global structure of the thermosphere is captured in four measurement requirements. All must be made from a near-polar orbiting platform to provide the geographic and local time coverage requirements.

THER-1

Measurement requirement THER-1 requires the measurement of the density of atomic oxygen from 120–250 km altitude in steps of 5 km, with a precision of 15%. These measurements are needed over the full range of Mars seasonal cycle covering all longitudes and latitudes to within 10 degrees of the poles. Coarse longitudinal resolution of 30 degrees and measurements covering the daylight local times are required.

This measurement requirement corresponds to a key part of the overall requirements for THER-1 through THER-4, which together provide the global 3D distribution of composition, density, temperature, and winds required to identify how energetics and dynamics of this region respond to forcing from the lower atmosphere and the sun (MOSAIC Investigation 4). Atomic O is one of the two main species that informs how the thermosphere interacts with the ionosphere, and is a good tracer for how lighter species may escape from Mars. The altitude range requirement covers the whole region in which O is found in abundance, out through the exobase, and the altitude resolution is around $\frac{1}{4}$ of the O scale height needed to track changes in a meaningful way. The spatial coverage provides almost the entire globe, and coarse resolution is acceptable given the current state of knowledge and is sufficient to identify atmospheric tidal signatures.

THER-2

Measurement requirement THER-2 corresponds to atmospheric temperature from 80–150 km altitude in steps of 2.5–5 km, with a precision of 10%. These measurements are needed over the full range of Mars seasonal cycle covering all longitudes and latitudes to within 10 degrees of the poles. Coarse longitudinal resolution of 30 degrees and measurements covering the daylight local times are required.

Temperature is an essential measure of the energetics of the thermosphere. The altitude range requirement covers the region from the cold middle atmosphere up to the point where the thermosphere is essentially isothermal with altitude. The variable altitude resolution reflects the changes in scale height across this region and provides $\frac{1}{3}$ scale height needed to meaningfully track changes with altitude. The spatial coverage provides almost the entire globe, and coarse resolution is acceptable given the current state of knowledge and is sufficient to identify atmospheric tidal signatures.

THER-3

Measurement requirement THER-3 corresponds to atmospheric composition. The primary requirement is to measure CO₂ and O, with a secondary requirement to measure NO, over 120–200, 140–200 and 50–100 km altitude, respectively. The composition is needed to 25% precision, in 5-km altitude steps. These measurements are needed over the full range of Mars seasonal cycle covering all longitudes and latitudes to within 10 degrees of the poles. Coarse longitudinal resolution of 30 degrees and measurements covering the daylight local times are required.

The primary species in the thermosphere are CO₂ and O, and in addition NO is important for energy balance and is included as a secondary target. The varying altitude ranges correspond to the altitudes at which these species are significant components of the atmosphere, both in terms of density and energy. The altitude resolution provides information at $\frac{1}{3}$ scale height needed to meaningfully track changes with altitude. The spatial coverage provides almost the entire globe, and coarse resolution is

acceptable given the current state of knowledge and is sufficient to identify atmospheric tidal signatures.

THER-4

Measurement requirement THER-4 corresponds to horizontal neutral winds, which are needed from 60-150 km altitude with a precision of 20 m/s, in 5-km altitude steps. These measurements are needed over the full range of Mars seasonal cycle covering all longitudes and latitudes to within 10 degrees of the poles. Coarse longitudinal resolution of 30 degrees and measurements covering the daylight local times are required.

Virtually no observations of winds exist in the thermosphere of Mars, and none fall within the altitude range where the middle and upper atmosphere meet. Knowledge of these winds is essential to understanding both the dynamics of the upper atmosphere, but also its connection to the middle atmosphere. The altitude range of the measurements provides the connection to the middle atmosphere, and reaches up to the altitude at which models suggest the winds no longer vary significantly with altitude. The altitude resolution permits the capture of wind shears that may be present e.g. in the lower thermosphere where the temperature begins to rise. The spatial coverage provides almost the entire globe, and coarse resolution is acceptable given the current state of knowledge and is sufficient to identify atmospheric tidal signatures.

B.1.3.5 Investigation 5: Ionosphere (IONO)

“Measure the global 3-D structure of Mars ionosphere, and its variability with season and solar activity.”

IONO-1

Baseline: Measure electron density in the range $0-10^6 \text{ cm}^{-3}$ with uncertainty $< 2 \times 10^3 \text{ cm}^{-3}$ over altitude range 80–250 km with 1–2 km vertical resolution at a rate of 150 profiles per day for 1 Mars year, where each day’s profiles are widely geographically dispersed.

Threshold: Measure electron density in the range $0-10^6 \text{ cm}^{-3}$ with uncertainty $< 2 \times 10^3 \text{ cm}^{-3}$ over altitude range 80–250 km with 2 km vertical resolution at a rate of 75 profiles per day for 1 Mars year, where each day’s profiles are widely geographically dispersed.

IONO-2

Baseline: Measure electron density in the range $10^2-10^5 \text{ cm}^{-3}$ with uncertainty $< 10^2 \text{ cm}^{-3}$ over altitude range 150-800 km with 0.5 second temporal resolution at a rate of 20 profiles per day for 1 Mars year, where each day’s profiles are widely geographically dispersed.

Threshold: Measure electron density in the range $2 \times 10^2-10^4 \text{ cm}^{-3}$ with uncertainty $< 2 \times 10^2 \text{ cm}^{-3}$ over altitude range 200–800 km with 1-second temporal resolution at a rate of 20 profiles per day for 1 Mars year, where each day’s profiles are widely geographically dispersed.

IONO-4 (IONO-3 was removed)

Baseline: Search for electron density irregularities between 100–200 km altitude with length-scale $> 1 \text{ km}$ and magnitude $> 5 \times 10^2 \text{ cm}^{-3}$ with 1–2 km vertical resolution at a rate of 150 profiles per day for 1 Mars year, where each day’s profiles are widely geographically dispersed.

Threshold: Search for electron density irregularities between 100–200 km altitude with length-scale $> 10 \text{ km}$ and magnitude $> 10^3 \text{ cm}^{-3}$ with 2 km vertical resolution at a rate of 75 profiles per day for 1 Mars year, where each day’s profiles are widely geographically dispersed.

Objectives IONO-1 and IONO-2 contribute to the following mission-level objectives:

- Objective I.C.1: Correlate variability in the thermosphere, ionosphere, and escape rates to conditions in the lower-middle atmosphere
- Objective I.C.2: Correlate variability in the thermosphere, ionosphere, and escape rates to the space weather environment

Objectives IONO-1, IONO-2, and IONO-4 contribute to the following mission-level objectives:

- Objective II.C: Characterize the Mars ionospheric state and variability sufficiently to determine its likely disruptive effect on communications and positioning.

The mission-level objectives I.C.1, I.C.2, and II.C require that ionospheric electron densities be measured with reasonable accuracy and vertical resolution over the full vertical extent of the ionosphere in many widely-dispersed locations at high temporal cadence.

The mission-level objective II.C requires that ionospheric irregularities that can cause scintillation be characterized.

Objectives IONO-1 and IONO-4 will be satisfied by spacecraft-to-spacecraft radio occultations. Objective IONO-2 will be satisfied by in situ electron density measurements by Langmuir probe-like instruments on the elliptical orbit smallsats.

B.1.3.6 Investigation 6: Exosphere (EXO) and Neutral Escape

“Measure the 3-D density and temperature structure of Mars’s hydrogen and oxygen exospheres”

EXO-1

EXO-1 lays out rough requirements for the measurement of hydrogen and oxygen escaping from the planet. Because direct detection of escaping neutral H and O at thermal energies is not feasible, the definitive technique for constraining this loss is measurement of ultraviolet light scattered by escaping and bound H and O atoms in the corona. While measurements of this brightness have been made since the early Mariner missions (e.g., Anderson & Hord 1971), reliable uncertainty analysis has only recently become computationally feasible (Chaffin et al. 2018). For this reason, the physical parameter retrieved (H and O escape rate) has relatively large uncertainty bounds when compared to other MOSAIC parameters. Nevertheless, the data we require as input to the retrieval is well-known: we require UV images of the planet at Lyman alpha (121.6 nm), Oxygen 130.4 nm, and perhaps Lyman beta (102.6 nm) wavelengths, covering the disk and inner corona to ~6 Mars radii. On the limb and disk, the spatial/altitude resolution of these measurements must be on the order of 15 km, the neutral atmospheric scale height, to resolve the thermospheric H profile and distinguish impulsive proton aurora from neutral H (Deighan et al. 2018, Ritter et al. 2018, Hughes et al. 2019). To constrain known spatial variability (e.g., Chaffin et al. 2015, Chaufray et al. 2015, Bhattacharyya et al. 2020), such images should be gathered from 4–6 vantage points around the satellite orbit, including images from near the subsolar point, the dawn and dusk terminators, with coverage of the nightside as Lyman alpha light is multiply scattered around the planet and illuminates even midnight. The measurement time cadence is set by the regular seasonal variability of H loss (Chaffin et al. 2014, Clarke et al. 2014, Halekas 2017), impulsive responses to dust events (Chaffin et al. 2019), and short timescale variability of the thermospheric inventory caused by solar impulsive events (Mayyasi et al. 2018), requiring a measurement cadence of at most several days to a week, in which all images must be gathered. By comparison with H, the O emission and retrieval is relatively straightforward and relies on optically thin radiative transfer coupled to an ionosphere/thermosphere escape model (Deighan et al. 2015).

B.1.3.7 Investigation 7: Magnetosphere (MAGN) and Ion Escape

“Measure (from multiple viewpoints) fluxes of light and heavy ions, magnetic field and topology, plasma waves, and electric fields within and between all regions of Mars’ hybrid magnetosphere.”

MAGN-01

Vector magnetic field: Measure the vector magnetic field from ~ 1 to 3000 nT with a sensitivity of 0.3 nT or 10%, whichever is larger, throughout the Mars environment. The magnetic field is essential for interpreting charged particle measurements. The magnetic field configuration and its topology (in conjunction with suprathermal electron measurements) are crucial for understanding the motion (and escape) of charged particles in the Mars environment. The wide dynamic range is needed to measure the solar wind field upstream of the bow shock as well as strong crustal magnetic fields near periapsis. The accuracy on the amplitude is primarily needed to constrain the magnetic field direction when the amplitude is small.

MAGN-02

Suprathermal electron flux: Suprathermal electrons, consisting of ionospheric primary photoelectrons, upstream and shocked solar wind electrons, and accelerated electrons in the induced magnetotail and crustal magnetic cusp regions span a wide range of fluxes. The lowest fluxes ($< 1e4$ eV/cm²-sec-ster-eV) are observed within “suprathermal electron voids” that occur on closed crustal magnetic field lines on the night hemisphere. The highest fluxes ($> \sim 1e9$ eV/cm²-sec-ster-eV) are observed just downstream of the bow shock and during energized precipitation (auroral) events in crustal magnetic field cusps.

MAGN-03

Suprathermal electron energy: Ionospheric primary photoelectrons span the energy range from ~ 1 eV to ~ 500 eV, with diagnostic features at 7 eV (corresponding to a minimum in the electron-neutral collision cross section), 22–24 eV (corresponding to photoelectrons produced by the intense solar He-II line at 304 nm), and 500 eV (corresponding to oxygen Auger electrons). Solar wind electrons, consisting of core and halo populations extend from a few eV to ~ 1 keV. Shocked magnetosheath electrons are energized but typically span a similar energy range. Higher energy electrons are occasionally produced by solar storms (Coronal Mass Ejections (CMEs), solar flares, and interplanetary shocks).

MAGN-04

Suprathermal electron angular distribution: Electrons in the solar wind and throughout the Mars environment have thermal velocities that are much larger than their bulk velocities (or spacecraft orbital velocities). Thus, electrons are incident from all directions. The electron angular distribution has anisotropies with respect to the magnetic field, from which magnetic topology, electrostatic potentials parallel to the magnetic field, and plasma heat flux can be determined. The field of view should be large enough that these anisotropies can be identified and measured. At a minimum, the field of view should cover $\sim 50\%$ of the sky and should include the typical solar wind magnetic field direction. An angular resolution of ~ 30 degrees is sufficient to characterize anisotropies.

MAGN-05

Ion flux (ionosphere/magnetosphere): Ion flux spans six orders of magnitude, from planetary pickup ions ($\sim 10^4$ eV/cm²-sec-ster-eV) to shocked solar wind H⁺ in the magnetosheath ($\sim 10^8$ – 10^9) to cold ionospheric O₂⁺ ($\sim 10^{10}$). Since the distribution does not change rapidly, low pickup ion fluxes can be measured over longer timescales (~ 10 min) to increase the signal to noise ratio.

MAGN-06

Ion energy (ionosphere/magnetosphere): With a periapsis velocity of ~ 4 km/s for the elliptical platforms, ionospheric O⁺ and O₂⁺ have energies of 1.5 and 3 eV, respectively. Cold ion outflow can occur at energies down to ~ 1 eV, and sometimes lower if the spacecraft is moving in the same

direction as the flow. Pickup O^+ ions have energies from nearly zero when they are initially ionized to ~ 50 keV (with gyro radii of several Mars radii) after they have been fully accelerated by the solar wind convection electric field. Ions that are picked up close to the planet, where the neutral density is much higher, have comparatively low energies because of the lower solar wind flow speed and the shorter distance to accelerate. Overall, the pickup ion distribution can be reasonably well characterized by measuring energies up to ~ 20 keV.

MAGN-07

Ion angular distribution (ionosphere/magnetosphere): In the magnetosheath, shocked solar wind ions are incident from all directions. Accurate plasma moments (density, temperature, Pa) depend on measuring as much of the angular distribution function as possible, preferably over the full sky. Below the exobase, ionospheric O^+ is beamed in the ram direction because of the spacecraft's supersonic orbital velocity. Above the exobase, ions can be accelerated by electric fields arising from several processes.

MAGN-08

Ion mass (ionosphere/magnetosphere): The mass analyzer portion of the ion instrument should be able to distinguish the major solar wind and planetary ions: H^+ , He^{++} , O^+ , O_2^+ , and CO_2^+ . This is important for constraining the source regions of the measured ion fluxes, for converting ion number fluxes to fluxes of the main species, and for calculating bulk velocity and temperature from the measured energy, direction, and mass.

MAGN-09

Ion flux (solar wind): The flux of the solar wind ion beam is typically in the range 10^7 to 10^{10} eV/cm²-sec-ster-eV. This range is encompassed by MAGN-05 above.

MAGN-10

Ion energy (solar wind): Solar wind velocities are typically from 250 to 750 km/s, corresponding to energies of 0.3-3 keV for H^+ and 1.2-12 keV for He^{++} . These ranges are encompassed by MAGN-06.

MAGN-11

Ion angular distribution (solar wind): Upstream of Mars' bow shock, the solar wind is a ~ 1 -keV beam typically several degrees wide and traveling radially away from the Sun. The beam is deflected and broadened when crossing the bow shock. A ~ 40 -degree-wide field of view centered on the Sun direction is needed to measure both the unperturbed and shocked solar wind

MAGN-12

Vector electric field: The electric fields associated with flows, flow diversions, and macro-scale instabilities are expected to have amplitudes smaller than ~ 300 mV/m (DC) with variations smaller than ~ 100 mV/m (AC). An accuracy of 1 mV/m or 10%, whichever is larger, allows these fields to be characterized.

MAGN-13

Electric field wave power: The low-frequency (< 60 Hz) electric field waves associated with current disruption and interchange-like instabilities in the magnetotail current sheet, as well as the higher frequency waves associated with energization, scattering, and loss of electrons, are expected to have wave powers in the range of 10^{-4} to 10^2 mV/m/sqrt(Hz). This power should be measured with an accuracy of 10^{-4} mV/m/sqrt(Hz) or 10%, whichever is larger, to allow this wave power to be characterized.

MAGN-14

Magnetic field wave power: The magnetic field component of plasma waves provides information to distinguish the various types of waves (e.g., ULF, whistler, Alfvén), which in turn provide insight into the physical mechanisms involved (e.g., magnetic reconnection, current disruption, plasma

instabilities, particle energization) and to calculate the Poynting flux ($E \times B$), which is a measure of electromagnetic energy flux through the plasma. Magnetic wave power is expected to be in the range of 10^{-4} – 1 nT/sqrt(Hz), which should be measured with an accuracy of 10^{-4} nT/sqrt(Hz) or 10%, whichever is larger.

B.1.3.8 Investigation 8: Space (SPA) Weather

“Measure magnetic field and plasma conditions in the upstream solar wind, and solar extreme ultraviolet irradiance.”

SPA-1

Solar EUV spectral irradiance: The spectral irradiance should be measured in three band passes that probe different regions of the solar atmosphere, which have very different time variability associated with different solar phenomena, such as active regions and flares. Based on well-established measurements at both Earth and Mars, this irradiance should have an intensity from 10^{-6} to 3×10^{-2} W/m²/nm and be measured with an accuracy of 15% (dI/I).

SPA-2

Vector magnetic field: Measure the vector magnetic field from ~ 1 to 3000 nT with a sensitivity of 0.3 nT or 10%, whichever is larger, throughout the Mars environment. The magnetic field is essential for interpreting charged particle measurements and for establishing the solar wind properties that drive the interaction with Mars’ ionosphere and crustal magnetic fields. The wide dynamic range is needed to measure the solar wind field upstream of the bow shock (~ 1 nT) as well as much larger fields associated with coronal mass ejections that impact Mars. The accuracy on the amplitude is primarily needed to constrain the magnetic field direction when the amplitude is small.

SPA-3

Ion flux: The flux of the solar wind ion beam is typically in the range 10^7 to 10^{10} eV/cm²-sec-ster-eV. This range is encompassed by MAGN-05 above.

SPA-4

Ion energy: Solar wind velocities are typically from 250 to 750 km/s, corresponding to energies of 0.3-3 keV for H⁺ and 1.2–12 keV for He⁺⁺. These ranges are encompassed by MAGN-06.

SPA-5

Ion angular distribution: Upstream of Mars’ bow shock, the solar wind is a ~ 1 -keV beam typically several degrees wide and traveling radially away from the Sun. The beam is deflected and broadened when crossing the bow shock. A ~ 40 -degree-wide field of view centered on the Sun direction is needed to measure both the unperturbed and shocked solar wind.

SPA-6

Suprathermal electron flux: Suprathermal electrons consist of upstream and shocked solar wind electrons and accelerated electrons in the induced magnetotail. The solar wind electron distribution at Mars typically peaks at an energy of ~ 10 eV with a flux of $\sim 10^8$ eV/cm²-sec-ster-eV. The highest fluxes ($> \sim 10^9$ eV/cm²-sec-ster-eV) are observed just downstream of the bow shock. The solar wind electron distribution also has a high-energy halo that can extend out to ~ 1 keV with fluxes down to 10^4 eV/cm²-sec-ster-eV. The halo distribution is typically anisotropic, with a component (the “strahl”) that is beamed along the magnetic field. The strahl is an important carrier of heat flux in the solar wind and can be used to determine the magnetic topology of the interplanetary magnetic field (i.e., whether one or both ends of the field line are connected to the solar corona).

SPA-7

Suprathermal electron energy: Solar wind electrons, consisting of core and halo populations extend from a few eV to ~1 keV. Shocked magnetosheath electrons are energized but typically span a similar energy range. Higher energy electrons are occasionally produced by solar storms (CMEs, solar flares, and interplanetary shocks). Measurements from ~1 to ~10 keV cover all but the most energetic (and rare) events. (These higher energy events are covered by SPA-9 to SPA-11.)

SPA-8

Suprathermal electron angular distribution: Electrons in the solar wind and throughout the Mars environment have thermal velocities that are much larger than their bulk velocities (or spacecraft orbital velocities). Thus, electrons are incident from all directions. The electron angular distribution has anisotropies with respect to the magnetic field, from which magnetic topology, electrostatic potentials parallel to the magnetic field, and plasma heat flux can be determined. The field of view should be large enough that these anisotropies can be identified and measured. At a minimum, the field of view should cover ~50% of the sky and should include the typical solar wind magnetic field direction. An angular resolution of ~30 degrees is sufficient to characterize anisotropies.

SPA-9

Energetic ion/electron flux: Energetic ions and electrons are produced in solar flares, in shock fronts driven by coronal mass ejections, and in other interplanetary shocks, such as those associated with solar wind stream interactions. Based on a long history of measuring these energetic species at Earth and Mars, a flux range of 10 to 10⁶ eV/cm²-sec-ster-eV with an accuracy of 10% is sufficient to characterize energetic particle events.

SPA-10

Energetic ion energy: Solar energetic ions span the range from a few keV to 10's of MeV; however, most of the energy deposition in the thermosphere results from ions with energies from 50 keV to a few MeV. An energy resolution of 50% ($\Delta E/E$) is sufficient to resolve energy input at different altitudes.

SPA-11

Energetic electron energy: Solar energetic electrons span the range from a few keV to 10's of MeV; however, most of the energy deposition in the thermosphere results from electrons with energies from ~50 to a few hundred keV. An energy resolution of 50% ($\Delta E/E$) is sufficient to resolve energy input at different altitudes.

B.1.4 Instrument Requirements Definition

For each required measurement in Table B-4 in Appendix B.1.5, the science working groups carried out an instrument review to determine instrument performance metrics from (where possible) multiple potential providers and to compare with measurement requirements. For instruments likely to meet requirements, instrument TRL was assessed using standard NASA definitions. Only TRL 3+ instruments were considered. In cases where TRL was lower than 6, the time and cost were estimated to bring the instrument up to TRL 5 and then 6. Instrument resources (power, mass, volume, data rate) were estimated for all potential flight instruments. In this way, for each measurement, a prioritized list was compiled of one or more instruments that can meet the science requirement. **In Appendix B.1.4, we describe each instrument, the measurement it makes, its resource (mass, power, data) and accommodation requirements, and concept of operations.** Also see Table B-5 in Appendix B.1.6 for performance metrics of instruments considered for the MOSAIC payload.

B.1.4.1 Subsurface and Surface Ice

P-band SAR + sounder (Mothership)

The threshold mission carries a fully polarimetric P-band combination SAR + sounder instrument on its mothership. The single, combined instrument uses a deployed 6-m dish antenna pointed either at 35° (SAR) or nadir (sounder) depending on the measurement mode. The antenna is pointed by rotating the entire mothership platform. The majority of the SAR components are currently TRL 8-9 based on ESA's Biomass instrument and will be TRL 9 by the launch of Biomass in the early 2020s. The sounder is TRL 9 based on NASA's SHARAD. The polarimetric SAR data product describes the power returned from the surface in the HH, HV, VH, and VV channels. The sounder data product is a radargram (i.e., vertical radar profile) describing the returned power from the surface and subsurface (to maximum 15 m depth) at nadir. Threshold data rates are 2.3 Mbps for the sounder and 0.25-2.75 Mbps for the SAR, resulting from an onboard compression factor of 80–889. It has an expected mass of 90 kg and a maximum power of 500 W. For each measurement mode (sounder, SAR) there will be 5 measurements/sol. Measurements will begin 1 month after arrival. Because the sounder and SAR share an antenna, they will not operate at the same time.

Wide angle imager (Mothership)

A wide angle imager, based on the design of the Johns Hopkins University Applied Physics Laboratory JHU/APL, MAVRIC was chosen to continue the multi-Mars-year record of surface ice (and weather) monitoring from MOC WA and MARCI. Expanding upon the range of these previous instruments, MAVRIC consists of six channels between 0.34–0.75 μm (UV+VIS) and an additional 6 channels between 1.1–1.6 μm (NIR). Similar to MARCI, images consist of a pole-to-pole swath with a 150° FOV in each band, passively building up near-global daily coverage in an always-on configuration on the day side of the planet that allows for simultaneous operation with other instruments aboard the mothership. The camera and electronics combined are 3.39 kg with a volume of 10 × 7.5 × 14 cm for the camera and 12 × 10 × 3.5 cm for the interface adapter. While operating it utilizes 2.1 W of power for the camera and 8.2 W for the electronics. Threshold data rates are 8.8 Gb/sol downlinked, with a collected orbit average of ~102 Kbps. Baseline data rates are 11 Gb/sol downlinked, with a collected orbit average of ~127 Kbps.

B.1.4.2 Lower and Middle Atmosphere

Thermal IR radiometer (Mothership)

A thermal IR radiometer to profile temperature, pressure, dust, water and CO₂ ice, and water vapor in the lower and middle atmosphere (Kleinböhl et al. 2009), and to derive atmospherically corrected surface temperature (Piqueux et al. 2016), is part of the threshold mission. The radiometer is TRL 9, being nearly identical to MCS onboard MRO (McCleese et al. 2007). Like MRO-MCS, the radiometer would observe surface and atmospheric emission from nadir and limb views, calibrated against views of space internal blackbody and solar reflection targets in 9 spectral channels. Each channel would consist of a linear array of uncooled thermopile detectors, which instantaneously measures a radiance profile when vertically pointed at the limb. The main difference would be the modification of one of the far infrared channels to allow the separation of aerosol and water vapor signals, enabling the accurate retrieval of water vapor profiles, which was not possible using MRO-MCS (Kleinböhl et al. 2016). MOSAIC-MCS would have a mass of 9 kg, use 18 W of power, and have a data rate of 4 kbps.

Wind LiDAR (mothership)

We have baselined the Mars LiDAR for global climate measurements from orbit (MARLI) direct-detection Doppler wind LiDAR, that is being developed at NASA GSFC under funding from the Planetary Instrument Concepts for the Advancement of Solar System Observations (PICASSO) and MatISSE programs (Cremons et al. 2020). It was scheduled to reach TRL 6 in June 2020, prior to a

suspension of work due to Coronavirus (COVID)-19. It consists of a 50 cm telescope and a 1064 nm laser that pulses at 250 Hz. The returned laser light passed through a Fabry-Perot etalon to discriminate the Doppler-shifted light that is backscattered by atmospheric dust and water ice aerosols. The receiver is sensitive to polarization to discriminate between dust and water ice aerosols. Under normal atmospheric dust loading, MARLI is sensitive to the line-of-sight wind speed from the surface to ~40 km altitude at a precision of ≤ 4 m/s at a vertical resolution of ~2 km. Under high dust loading, MARLI is more sensitive (precision of ≤ 2 m/s) and can retrieve wind speed to higher altitudes. Aerosol extinction has 10% or less relative error. For MOSAIC, we have included a tilt table that would allow MARLI to retrieve the full wind vector. Including the tilt table, MARLI is 45 kg, uses 91 W of power, and has a data rate of < 100 kbps with a 90% duty cycle.

Submillimeter sounder (Mothership)

A sub-millimeter sounder, developed at JPL to TRL 5, is baselined to connect the lower atmospheric winds observed by the wind LiDAR to the upper atmospheric and thermospheric winds observed by the wind Doppler interferometer. It consists of two independently steerable receivers, oriented orthogonally and scanning between 12° and 32° below horizontal, to retrieve the full wind vector. The receivers have a 3 GHz bandwidth centered on 450 GHz to retrieve wind speed, water vapor, deuterated water vapor (HDO), and temperature profiles ~10–80 km altitude with 6–9 km vertical resolution for wind and 3–4 km vertical resolution for gas species and temperature. Precision is 15 m/s wind speed for a single profile, which is reduced to 5–10 m/s with averaging, < 9 ppm for water vapor below 50 km, < 0.1 ppm for HDO below 50 km, and < 2 K for temperature. Sub-millimeter observations are insensitive to atmospheric dust loading. The instrument is 35 kg and uses 39 W on average, 50 W at peak operation. Its baseline data rate is 40 kbps.

Near IR spectrometer (Mothership, Areo Carrier, Areo SmallSats A/B, and Polar SmallSat)

We have thresholded a highly compact near IR spectrometer known as Argus 2000 to measure surface pressure from low Mars and areostationary orbits. Argus 2000, developed by Thoth Technologies (Canada) is TRL 9 with heritage from Argus 1000 (Jagpal et al. 2010), which flew on the CanX-2 nanosatellite mission in 2008. TRL may be rated lower because of the proposed use of the extended version of the spectrometer, which observes the NIR spectrum from 1000–2400 nm at 6 nm resolution to fully resolve the CO₂ band structure in reflected sunlight and collect the necessary information to correct for surface albedo and atmospheric effects. From this information, column abundance of CO₂ then can be retrieved to obtain surface pressure (Toigo et al. 2013). Argus 2000 is a point spectrometer with an IFOV of 2.18 mrad, giving it a resolution of < 1 km on the mothership and polar smallsat (excluding smearing during integration) and of < 40 km from an areostationary orbit, where it may be slewed along with other instruments observing the disk. The instrument is 300 g, uses < 2.5 W of power, and has a threshold data rate of 1047 bps (assumes a high degree of on-board processing).

Visible camera (Areo Carrier and Areo SmallSat A/B)

We have thresholded a highly compact, high resolution multispectral/hyperspectral imager known as Chameleon to observe from areostationary orbit the extent and duration of dust and ice clouds. Chameleon is TRL 6, having heritage from the SCS Aerospace Group Gecko Imager aboard the private South African nSight-1 satellite launched from the International Space Station in 2017 (Malana et al. 2018, Mhangara et al. 2020). Developed by Space Advisory Company (South Africa), Chameleon would be configured for MOSAIC to observe in panchromatic mode and 8 multispectral channels to cover the typical visible/near-infrared range of past Mars weather cameras. It would have a resolution of ~400 m in areostationary orbit, but with a FOV of 5.6 degrees, it would need to be scanned to cover the Martian disk with ~14 non-overlapping images. The instrument is 1.6 kg, uses < 7 W of power, and has a baseline data rate of 30 Mbps, which could be significantly reduced by spatial and channel averaging and aerosol type identification during on-board processing.

Thermal IR radiometer (Aero Carrier and Aero SmallSat A/B)

A miniaturized thermal IR filter radiometer to profile temperature and pressure; measure dust, water and CO₂ ice, and water vapor column opacity in the lower and middle atmosphere; and derive atmospherically corrected surface temperature, is part of the threshold mission for the areostationary orbiters. The radiometer is TRL 6, being a miniaturized version of MCS onboard MRO (McCleese et al. 2007) but designed to fit (including a mirror for pointing) into a 2 U cubesat form factor. The subsystems have heritage from the Polar Radiant Energy in the Far-InfraRed Experiment (PREFIRE, Drouin and L'Ecuyer 2018) under development at JPL and scheduled for launch in 2021. The radiometer would observe surface and atmospheric emission from approximately nadir views made by raster scanning across the disk with flip mirrors. Note that disk scanning by MRO-MCS was demonstrated during MRO aerobraking (McCleese et al. 2007). These views would be regularly calibrated against views of space internal blackbody and solar reflection targets in 9 spectral channels. Each channel would consist of a linear array of uncooled thermopile detectors with an individual detector resolution of ~60 km in areostationary orbit. The main difference with MRO-MCS (excluding miniaturization and adaptation to the areostationary platform) would be the modification of one of the far infrared channels to allow the separation of aerosol and water vapor signals, enabling the accurate retrieval of water vapor profiles, which was not possible using MRO-MCS (Kleinböhl et al. 2016). MOSAIC-mini-MCS is expected to have a mass of 3.5 kg, use 8 W of power, and a data rate of 4 kbps.

Mini thermal IR radiometer (Polar SmallSat)

A miniaturized thermal IR filter radiometer to profile temperature, pressure, dust, water and CO₂ ice, and water vapor in the lower and middle atmosphere, and derive atmospherically corrected surface temperature, is part of the threshold mission. The radiometer is TRL 6, being a miniaturized version of MCS onboard MRO (McCleese et al. 2007) but designed to fit (including a mirror for pointing) into a 2 U cubesat form factor. The subsystems have heritage from the PREFIRE (Drouin and L'Ecuyer 2018) under development at JPL and scheduled for launch in 2021. Like MRO-MCS, the radiometer would observe surface and atmospheric emission from nadir and limb views, calibrated against views of space internal blackbody and solar reflection targets in nine spectral channels. Each channel would consist of a linear array of uncooled thermopile detectors, which instantaneously measures a radiance profile when vertically pointed at the limb. The main difference with MRO-MCS (excluding miniaturization) would be the modification of one of the far infrared channels to allow the separation of aerosol and water vapor signals, enabling the accurate retrieval of water vapor profiles, which was not possible using MRO-MCS (Kleinböhl et al. 2016). MOSAIC-mini-MCS is expected to have a mass of 3.5 kg, use 8 W of power, and a data rate of 4 kbps.

B.1.4.3 Thermosphere

Wind doppler interferometer (Mothership)

The wind Doppler interferometer makes measurements of the horizontal winds from 60–150 km during daytime. It consists of 2 identical units, each of which measures the line-of-sight Doppler shift of both 557.7 nm and 1.27 μ m airglow. The two lines of sight are mounted at 45 degrees and 135 degrees to spacecraft ram direction, allowing both components of the horizontal wind to be obtained on the limb. All altitudes are measured simultaneously, limiting moving parts. The 2 units together have a mass of 40 kg, require 13 W of power, and produce an orbit-averaged data rate of 14 kbps. To use the measurements of the line-of-sight Doppler shift to infer winds, precise knowledge of the spacecraft pointing are needed, in addition to pointing control that maintains the limb view in the correct orientation. Measurements are made at all points on the dayside, with at least 1 measurement every two degrees of travel of the spacecraft.

FUV/MUV spectrograph (Mothership)

The FUV/MUV spectrograph measures a number of emissions from CO₂, O on the limb during daytime, and NO during nighttime, over an altitude range spanning 50–250 km. A single unit is limb-mounted and requires sufficient attitude control to maintain its limb pointing. The instrument can either image the entire limb at once, or employ a scan mirror to sample all these altitudes. The instrument mass is 15–27 kg, power is 15–28 W for the imaging/scanning variants, respectively. The orbit-averaged data-rate is 13 kbps. The instrument places stringent contamination controls, and possibly some materials selection restrictions on the rest of the spacecraft as the optics can be damaged by organic and volatile compounds. Some heritage instruments have required continuous N₂ purging while in air.

B.1.4.4 Ionosphere

Three instrument types were considered to satisfy requirement IONO-2: a multi-needle Langmuir probe, two planar ion probes, and a floating potential probe, all located on each elliptical spacecraft. This four-sensor package is being developed for the EscaPADE mission (Preliminary Design Review (PDR) August 2020) and is currently TRL 6. It would make measurements only below 1000 km. Its total estimated mass and power is 0.5 kg and 1.5 W, respectively.

The multi-needle Langmuir probe would make measurements of electron density (requirement IONO-2). Its mass would be 0.2 kg (electronics) + 0.05 kg (sensor) + to be defined (TBD) (harness) + TBD (boom). Its power consumption would be <1 W. It would be mounted on a boom that is desired to be 0.5 m in length. Each sample of data would contain 112 bits. The sampling rate would be 1 Hz. The orbit-averaged data rate would be 10 bps.

Two planar ion probes would make measurements of total ion density, which service calibration for total electron density (requirement IONO-2). Its mass would be 0.1 kg (electronics) + 0.1 kg (sensor) + TBD (harness). Its power consumption would be < 0.5 W. It would be mounted as flat gold panels on the side and top of the spacecraft with area 20 cm x 20 cm. Each sample of data would contain 32 bits. The sampling rate would be 1 Hz. The orbit-averaged data rate would be 10 bps.

The floating potential probe would make measurements of relative changes in spacecraft potential, and so is necessary for calibration of electron and ion density measurements from mNLP and PIP, respectively.

Radio occultation measurements of electron density in support of requirements IONO-1 and IONO-4 are described in the nearby Radio Science section.

B.1.4.5 Exosphere

An FUV spectrograph mounted on an areostationary platform is sufficient to fulfill the measurement requirements for the exosphere investigation. Such a spectrograph produces a spectral image, recording brightness as a function of wavelength along a 1D slit typically 10 degrees in length. To build 2D images, the instrument requires spacecraft pointing along at least one axis, which can be combined with an internal scan mirror to reduce the amount of spacecraft pointing required. Combined motion from the spacecraft is required to raster the slit across the planet to high altitude in order to build an image from the 1D slit.

An FUV spectrograph typically measures wavelength ranges of ~110–170 nm, with an optional extension to lower wavelengths enabling measurement of Lyman beta and higher fidelity in the escape rate measurement at the cost of added complexity in instrument and detector design, because measuring wavelengths less than 110 nm requires specialized detectors that cannot be exposed to water or oxygen.

These spectrographs are TRL 9 with extensive design heritage, having flown in space since the early Mariner missions. Contemporary examples include MAVEN/IUVS, New Horizons/Alice, and EMUS on the Emirates Mars Mission. These spectrographs as built by LASP have typically weighed ~ 20 kg, consumed ~ 20 W of power and occupied $\sim 60 \times 25 \times 15$ cm of volume. Data rates are highly configurable given the many on-board options for binning and reducing the data, but we estimate for MOSAIC that the typical data rate will be ~ 2 Gbit/week, with a threshold rate $4\times$ lower.

B.1.4.6 Magnetosphere, Ion Escape, Space Weather

Fluxgate magnetometer (Elliptical, Areo Carrier, and Areo SmallSat A/B platforms)

We have baselined a vector fluxgate magnetometer that measures the intensity and direction of the magnetic field—interplanetary, induced magnetospheric, ionospheric and crustal. These measurements, when combined with pitch angle distributions from the electron spectrometer, help to determine the magnetic structure and topology of the ionosphere, magnetosphere, and magnetotail, as well as low-frequency wave behavior. The magnetometer operates over a very large dynamic range, from ± 2048 nT, accommodating the largest field associated with Martian crustal magnetic anomalies (measured from orbit), to $\pm 65,536$ nT, allowing operation in the Earth's field. A 16-bit A/D converter results in a resolution of 0.06 nT. The overall sensitivity to ambient fields further depends on spacecraft magnetic cleanliness and the ability to remove spacecraft generated fields. The instrument operates continuously with a nominal cadence of 1 vector per second, although higher cadences are possible. The instrument has a mass of 1.3 kg (including a boom) and consumes 4.9 W (including heaters). It is highly desirable to have two identical magnetometers, one mounted at the end of the boom and a second mounted closer to the spacecraft. This gradiometer configuration greatly improves the ability to quantify and remove spacecraft generated fields. This instrument has been flown on numerous missions from Voyager to Juno, including two successful Mars missions: MGS and MAVEN. It is TRL 9.

Ion and electron spectrometers (Elliptical platform)

We have baselined a pair of top-hat, hemispheric electrostatic analyzers that measure ion and electron energy per charge. These are largely based on the THEMIS design, which is optimized for a spinning spacecraft. These sensors have energy resolutions for electrons and ions of 15% and 19% (dE/E, FWHM), respectively. The sensors have programmable energy sweeps that can extend from < 1 eV to > 20 keV. The instruments operate continuously, generating 32 energy sweeps (64 sweeps for the ion sensor in solar wind mode) per spin. Both sensors have an instantaneous 180×6 degree field of view, with the 6-deg rotating with the spacecraft to provide $4\text{-}\pi$ steradian coverage each spin. Angular resolution is 11.25 deg in rotation phase. Depending on the spacing of 8–16 discrete anodes along the 180-deg, angular resolutions ranging from 5.625 deg (to resolve the solar wind ion beam) to 22.5 deg are typical. The ion instrument would include a time-of-flight section similar to the MAVEN-STATIC design to separate solar wind H^+ and He^{++} , as well as the major planetary ions (O^+ , O_2^+ , CO_2^+). The combined ion-electron instrument is expected to have a mass of ~ 5 kg and consume ~ 6 W. The electron instrument is TRL 9. The components of the ion instrument (electrostatic analyzer and time-of-flight mass spectrometer) are flight proven through successful mission operations (THEMIS-ESA and MAVEN-STATIC), although this particular configuration has not been flown. Thus, the ion instrument is TRL 6.

Electric field instrument (Elliptical platform)

The Electric Field Instrument measures the three components of the ambient electric field over a range of ± 300 mV/m (DC) and ± 100 mV/m (AC). Waveform measurements cover DC up to 4 kHz, with AC coupled differential measurements from ~ 10 Hz to 8 kHz. On-board spectral measurements cover the same ranges, as well as providing an estimate of integrated power in the 100- to 400-kHz band. The instrument also measures the spacecraft floating potential. The instrument operates

continuously, producing spin-averaged vectors, waveform data, and spectral data, which can be configured to fit within the available telemetry bandwidth. The instrument is composed of six sensors (high-input-impedance, low-noise, broadband digital voltmeters) with preamps at the ends of six booms: four spin-stabilized 22-meter wire booms orthogonal to the spin axis and two 2.5-meter stacer booms along the spin axis. The mass including booms is 12 kg, and the instrument consumes 0.24 W. This instrument is TRL 9.

Search coil magnetometer (Elliptical platform)

The tri-axial Search Coil Magnetometer is designed to measure the magnetic components of plasma waves in the Mars environment. Three search coil antennas cover the bandwidth from 0.1 Hz to 4 kHz, which provides overlap with the fluxgate magnetometer. Each antenna consists of a high magnetic permeability core (which amplifies the ambient field) surrounded by two wire windings. The main winding, with $\sim 50,000$ turns, passively detects voltage induced by the changing external field. The secondary winding is used to induce feedback to flatten the temperature-dependent frequency response. The sensor is mounted at the end of a rigid one-meter boom. The instrument operates continuously, producing waveforms, FFT processed data, and filter-bank data. The instrument has a mass of 1.8 kg and consumes 0.075 W. The instrument has flown on eight Earth-orbiting and interplanetary missions, most recently THEMIS. It is TRL 9.

Ion spectrometer (Aero Carrier and Aero SmallSat A/B platforms)

The ion spectrometer for the non-spinning areostationary platform is a toroidal electrostatic analyzer with electrostatic deflectors to provide a 360×90 degree field of view, with a mechanical attenuator to provide a high dynamic range. The instrument measures ions from 5 eV to 25 keV with an energy resolution of 14.5% (dE/E, FWHM) and an angular resolution of 3.75×4.5 deg in the sunward direction and 22.5×22.5 deg elsewhere. The instrument operates continuously, generating energy-angle distributions, energy spectra, and bulk moments. These data products are packaged into telemetry with different (adjustable) cadences to fit within the available telemetry bandwidth. This instrument would be based closely on MAVEN-SWIA, which has a mass of 2.6 kg and consumes 2.1 W. It is TRL 9.

Electron spectrometer (Aero Carrier and Aero SmallSat A/B platforms)

The electron spectrometer is a hemispherical electrostatic analyzer with electrostatic deflectors to provide a 360×120 degree field of view. The instrument measures the energy and angle distributions of electrons from 3 eV to 4.6 keV with an energy resolution of 17% (dE/E, FWHM) and an angular resolution of 22.5×20 degrees. The instrument has two concentric toroidal entrance grids across which a sweepable potential can be placed to decelerate electrons as they enter the analyzer. This can be used to provide finer energy resolution for measuring ionospheric photoelectrons, for lowering the sensitivity to high magnetosheath fluxes, and to calibrate the low-energy response in flight. The instrument operates continuously, generating energy-angle distributions, pitch angle distributions (PADs), and energy spectra with different cadences to fit within the available telemetry bandwidth. Pitch angle distributions are calculated onboard in real time using data from the fluxgate magnetometer. This allows high-cadence PADs with modest telemetry usage. This instrument would be based closely on MAVEN-SWEA, which has a mass of 1.8 kg and consumes 1.6 W. It is TRL 9.

Solid state telescope (Energetic Particle Detector) (Aero Carrier and Aero SmallSat A platforms)

The solid state telescope measures the energy spectrum and angular distribution of energetic electrons (20 to 1000 keV) and ions (20 to 6000 keV). It consists of two identical sensors located on the spacecraft body. Each sensor consists of a dual, double-ended telescope that collimates ions and electrons onto a stack of three passivated ion-implanted silicon detectors. One end of the telescope is covered by a foil that stops ions below 400 keV, while the opposite end has a broom magnet that sweeps away electrons below 400 keV, so ions and electrons below this energy are cleanly separated. Higher energy electrons and ions are identified by the energy loss in an outside detector (dE/dx)

coincident with the energy (E) deposited in the center detector. Two telescopes are packaged with oppositely directed sweep magnets sharing a yoke to save mass and minimize stray fields. Each telescope has a rectangular 42×31 degree FOV. The instrument operates continuously, measuring events 10 times per second, which are collected, accumulated, and packetized to fit within the available telemetry bandwidth. A total of 128 energy/angle bins are available for accumulations, allowing 16 energy steps \times 4 angles \times 2 species per time step. The instrument has a mass of 0.9 kg and consumes an average power of 5.5 W. This instrument has been flown on MAVEN, THEMIS, and Wind. It is TRL 9.

EUV monitor (Aero Carrier and Aero SmallSat A platforms)

The EUV monitor is a set of four photometers that consist of very stable Si photodiodes covered by thin metal film or interference filters and a pre-amplifier circuit. Different filters provide sensitivity in three wavelength ranges: C/Al/Nb/C thin foil (17–22 nm), C/Al/Ti/C thin foil (0.1–7 nm), and an interference filter for Ly-alpha (121–122 nm). A fourth diode is permanently covered to monitor variations in dark signal due to temperature and radiation background changes. The three science channels monitor emissions from the highly variable corona and transition region of the solar atmosphere. The instrument operates continuously with a measurement cadence of 1 second. The broadband sensors monitor the most rapid changes in solar irradiance due to flares. These measurements can be used in a spectral irradiance model (M-FISM) to generate the full EUV spectrum at Mars from 0 to 190 nm in 1-nm bins. The instrument has a mass of 1.1 kg and consumes 0.73 W. The instrument is based on MAVEN-EUVM, with three modifications: (1) a smaller, lower power electronics box, (2) a smaller, lower mass photometer system, and (3) a modified optical path that includes a reflection to reject soft X-rays for improved sensitivity in the 17–22-nm channel. It is currently TRL 4, but could be brought to TRL 6 within \sim 6 months.

B.1.4.7 Radio Science

The radio occultation experiment would make measurements of electron density (requirement IONO-1) and electron density irregularities (requirement IONO-4). It would conduct spacecraft-to-spacecraft radio occultations between the Mothership, Polar spacecraft, and Elliptical spacecraft. Observations would be acquired by transmitting a carrier-only radio signal from one spacecraft to another at times when one spacecraft is entering into/emerging from occultation behind Mars from the perspective of the other spacecraft. The instrument would make use of spacecraft communications systems, but would also require a dedicated transponder. For small spacecraft, the strawman transponder would be the JPL IRIS transponder. For the larger mothership, the strawman transponder would be the JPL UST. For this application, both transponders are judged to be TRL $>$ 6. The IRIS transponder has a mass of 1.45 kg, power consumption of $<$ 33 W, and volume of 10 cm \times 10 cm \times 5 cm. The antenna boresight would be steerable in a range of ± 60 degrees in azimuth and ± 10 degrees in elevation about the velocity and anti-velocity directions. A 1.5 kg ultra-stable oscillator would also be required. The experiment would operate in UHF, L, or S band with dual-frequency observations preferred. Each sample of data would contain 16 bits, 8 bits for the I component of the radio signal and 8 bits for the Q component of the radio signal. The sampling rate would be 1 kHz for the electron density measurements (requirement IONO-1) and 1 Hz for the scintillation measurements of irregularities (requirement IONO-4). The orbit-averaged data rate would be 11 kbps. Onboard data processing might be able to reduce this data rate significantly.

B.1.5 Measurement Requirements Table

Table B-4. MOSAIC Measurement Requirements.

ID	Instrument Type(s)	Physical Parameter (PP) Description	Link to Objectives	Units	PP Range	PP Resolution	PP Altitude Range	PP Altitude Resolution	PP Coordinate System	PP Local Time (LT) Range	PP LT Resolution	PP Longitude Range	PP Longitude Resolution	PP Latitude Range	PP Latitude Resolution	PP Cadence	PP Seasonal Range	PP Seasonal Resolution	Observable Quantity (OQ).										Mass (where applicable)							
																			Separate from physical parameter for remote data.										Angular FOV (X) range	Azimuth (X) Resolution	Polar (Y) Range	Polar (Y) Resolution	Energy/Wavelength/Frequency Range	Resolution	Mass Range	Mass Resolution
																			OQ Description	OQ Units	OQ Dynamic Range	OQ Precision	OQ SNR	OQ Time Resolution												
ICE-1	Radar (P-band Polarimetric SAR)	Surface ice distribution over time	Objectives I.A. - II.A. Essential for monitoring of surface changes due to volatile exchange with the atmosphere and for the characterization of potentially extractable water ice resources	Percent ice coverage per unit area over time	0-100%	10%	0 m	N/A	IAU Mars	0-24 h	N/A	180°W - 180°E	30 m	80°S - 80°N	30 m	N/A - Cadence determined by orbital speed and longitude/latitude resolution	0-360° Ls	90°	Returned radar power as a ratio of a standard power	Watts or dimensionless	-30 dB to infinity (saturation level of instrument)	-30 dB noise limit	9	N/A - Cadence determined by orbital speed and longitude/latitude resolution.	N/A - no imaging. Each integration is one "pixel"	0.15°	N/A - no imaging. Each integration is one "pixel"	3°	350-450 MHz	N/A each pulse is a multi-frequency 'chirp'	N/A	N/A				
ICE-2	Radar (P-band Polarimetric SAR)	Near-surface moisture content	Objectives I.A. - II.A. Essential for monitoring of surface changes due to volatile exchange with the atmosphere and for the characterization of potentially extractable water ice resources	Percentage (%)	0-100%	Moisture content: 0-1 cm ³ /cm ³	0-3 m subsurface	Bulk measurement (no resolution, sensitive to entire column)	IAU Mars	0-24 h	N/A	180°W - 180°E	30 m	80°S - 80°N	30 m	N/A - Cadence determined by orbital speed and longitude/latitude resolution	0-360° Ls	90°	Circular polarization ratio	Dimensionless	0-2	0.1	N/A	N/A - Cadence determined by orbital speed and longitude/latitude resolution.	N/A - no imaging. Each integration is one "pixel"	0.15°	N/A - no imaging. Each integration is one "pixel"	3°	350-450 MHz	N/A each pulse is a multi-frequency 'chirp'	N/A	N/A				
ICE-2	Radar (P-band Sounder)	Near-surface moisture content	Objectives I.A. - II.A. Essential for monitoring of surface changes due to volatile exchange with the atmosphere and for the characterization of potentially extractable water ice resources	Percentage (%)	0-100%	Moisture content: 0-1 cm ³ /cm ³	1-15 m subsurface	0.8 m in water ice	IAU Mars	0-24 h	N/A	180°W - 180°E	1 km	80°S - 80°N	1 km	N/A - Cadence determined by orbital speed and longitude/latitude resolution	0-360° Ls	90°	Dielectric permittivity	Dimensionless	0-15	0.1	maximum 9 (decreases with depth)	N/A - Cadence determined by orbital speed and longitude/latitude resolution.	N/A - no imaging. Each integration is one "pixel"	0.15°	N/A - no imaging. Each integration is one "pixel"	3°	350-450 MHz	N/A each pulse is a multi-frequency 'chirp'	N/A	N/A				
ICE-3	Wide angle imager (VIS)	Surface ice distribution over time	Objectives I.A. - II.A. Essential for monitoring of surface changes due to volatile exchange with the atmosphere and for the characterization of potentially extractable water ice resources	Percent ice coverage per unit area over time	0-100%	10%	N/A	N/A	IAU Mars	Daytime	N/A	180°W - 180°E	1 km	80°S - 80°N	1 km	Daily global coverage (as downlink rate allows)	0-360° Ls	90°	RGB values	Data number (DN)	0-2047 (11 bit)	< 10% (VIS), < 20% (UV)	> 100 (VIS)	10-100 s msec (VIS), 1-10 s sec (UV)	22°	0.01°	22°	0.01°	0.34-0.75 μm, 1.1-1.6 μm	6 channels between 0.34-0.75 μm, 6 channels between 1.1-1.6 μm	N/A	N/A				
ATM-1	Radio occultation	Vertical profile of temperature	Objectives I.B. - I.C.1. - II.B. Essential for monitoring of atmospheric state and collection of/comparison with long-term climatologies.	Kelvin	150-300 K	1 K near the surface (10 K at 40 km)	0-40 km	2 km or less	PC	0-24 h	depends on number of satellites and orbits	180°W - 180°E	~ 1°	90°S - 90°N possible (depends on orbits)	~ 1 deg	up to ~30 soundings/daily per pair of spacecrafts	0-360° Ls	depends on number of satellites and orbits	Doppler shift	Hz	10 Hz at X-band	10 mHz at X-band	50 dB-Hz	0.1 sec	60°	N/A	10°	N/A	1-10 GHz	N/A	N/A	N/A				
ATM-2	Radio occultation (Added Sub-mm here as note that it's derived along with other variables)	Vertical profile of pressure	Objectives I.B. - I.C.1. - II.B. Essential for monitoring of atmospheric state and collection of/comparison with long-term climatologies.	Pascals	10 ⁻³ - 10 ³ Pa, Sub-mm: derived with other variables	2 Pa near the surface (0.6 Pa at 40 km)	0-40 km	2 km or less	PC	0-24 h	depends on number of satellites and orbits	180°W - 180°E	~ 1°	90°S - 90°N possible (depends on orbits)	~ 1 deg	up to ~30 soundings/daily per pair of spacecrafts	0-360° Ls	depends on number of satellites and orbits	Doppler shift	Hz	10 Hz at X-band	10 mHz at X-band	50 dB-Hz	0.1 sec	60°	N/A	10°	N/A	1-10 GHz	N/A	N/A	N/A				

Table B-4. MOSAIC Measurement Requirements.

ID	Instrument Type(s)	Physical Parameter (PP) Description	Link to Objectives	Units	Observable Quantity (OQ).																			Mass (where applicable)										
					PP Range	PP Res-olution	PP Altitude Range	PP Altitude Res-olution	PP Coord-inate System	PP Local Time (LT) Range	PP LT Res-olution	PP Long-itude Range	PP Long-itude Res-olution	PP Latitude Range	PP Latitude Res-olution	PP Cadence	PP Seasonal Range	PP Seasonal Res-olution	Separate from physical parameter for remote data.					Angular FOV Azimuth (X) range	Azimuth (X) Resolution	Polar (Y) Range	Polar (Y) Res-olution	Energy/Wavelength/Frequency Range	Resolution	Mass Range	Mass Res-olution			
																			OQ Description	OQ Units	OQ Dynamic Range	OQ Precision	OQ SNR									OQ Time Resolution		
ATM-3	Thermal infrared spectrometer/radiometer/differential integrated absorption lidar/sub-mm sounder	Vertical profile of temperature	Objectives I.B. - I.C.1. - II.B. Essential for monitoring of atmospheric state and collection of/comparison with long-term climatologies.	Kelvin	110-260 K	1 K. Sub-mm: 2 K	0-80 km	5-10 km. Sub-mm: 4 km vertical resolution between 0-25 km and 5-10 km vertical resolution between 25-70 km, for a single profile. Averaging would improve precisions.	PC	2 local times (2-3AM/PM)	1 h	180°W - 180°E	Instrument-dependent, ideally smaller than PP latitude resolution	85°S - 85°N. Sub-mm: Depends on orbit	1-4°	20 sols	0-360° Ls	1°-2° Ls. Sub-mm: Nominally continuously	Radiance/integrated intensity of returned power signal on line (differential integrated absorption lidar), Sub-mm: radiance	TIR: mW m ⁻² sr ⁻¹ (cm ⁻¹); DIAL: Photons/s/s; Sub-mm: W m ⁻² sr ⁻¹ GHz ⁻¹	Instrument-dependent	Sub-mm system T 1000 K	Instrument-dependent	Sub-mm: Variable; nominally scan 0-150 km in 75 sec to achieve precisions stated; slower scanning increases precision at the expense of latitudinal coverage.	2	Sub-mm: 2 antennas, each with 180° azimuth scanning capability	N/A	N/A	N/A	N/A	Around 15 micron (CO ₂ absorption band); integrated intensity near 1600 nm (differential integrated absorption lidar) Sub-mm: ~455 GHz +/- 10 GHz; tunable	Sub-mm: 75 MHz	N/A	N/A
ATM-4	Thermal infrared spectrometer/radiometer/differential integrated absorption lidar	Vertical profile of pressure	Objectives I.B. - I.C.1. - II.B. Essential for monitoring of atmospheric state and collection of/comparison with long-term climatologies.	Pascals	10 ⁻³ - 10 ³ Pa	5%	0-80 km	5-10 km	PC	2 local times (2-3AM/PM)	1 h	180°W - 180°E	Instrument-dependent, ideally smaller than PP latitude resolution	85°S - 85°N	1-4°	20 sols	0-360° Ls	1°-2° Ls	Radiance ratio/returned power (differential integrated absorption lidar)	TIR: mW m ⁻² sr ⁻¹ (cm ⁻¹); DIAL: Photons/s/s	Instrument-dependent	Instrument-dependent	Instrument-dependent	N/A	N/A	N/A	N/A	N/A	N/A	Around 15 micron (CO ₂ absorption band) [radiance ratio technique]; line width of CO ₂ line near 1600 nm (differential integrated absorption lidar)	N/A	N/A	N/A	
ATM-5	Microwave/sub-mm limb and doppler lidar	Vertical profile of horizontal wind in its zonal and meridional components (U,V)	Objectives I.B. - I.C.1. - II.B. Novel and relatively direct measurement of the atmospheric circulation	Meters per second	0-180 m/s	5 m/s	0-80 km	≤10 km	PC	2 local times (2-3AM/PM)	1 h	180°W - 180°E	Instrument-dependent, ideally smaller than PP latitude resolution	85°S - 85°N	< 5°	20 sols	0-360° Ls	1°-2° Ls	Doppler shift in gas emission lines (submm) Doppler shift in backscattered laser light (lidar)	MHz	140 MHz (lidar)	5 MHz (lidar)	20-50 (lidar)	2 s	360°	60 microrad (lidar), 0.002 rad (sub-mm)	N/A	N/A	N/A	N/A	1064 nm (lidar); Sub-mm: ~455 GHz +/- 10 GHz; tunable	1.8 MHz (lidar); ~6 kHz (sub-mm)	N/A	N/A
ATM-6	Thermal infrared spectrometer/radiometer - NIR spectrometer/lidar	Vertical profile of dust opacity	Objectives I.B. - I.C.1. - II.B. Essential for monitoring of atmospheric state, dust storms, and collection of/comparison with long-term climatologies.	Per kilometer	10 ⁻⁶ -10 ⁻¹ km ⁻¹ (referenced to 1064 nm)	1-20%	0-80 km	< 5 km	PC	2 local times (2-3AM/PM)	1 h	180°W - 180°E	Instrument-dependent, ideally smaller than PP latitude resolution	85°S - 85°N	~1°	20 sols	0-360° Ls	1°-2° Ls	Radiance (TIR spectrometer); returned energy (lidar); polarization (lidar possible)	TIR: mW m ⁻² sr ⁻¹ (cm ⁻¹); Lidar: Photons/s/s; Polarization: dimensionless ratio	Instrument-dependent	Instrument-dependent	Instrument-dependent	Instrument-dependent	N/A	60 microrad (lidar)	N/A	N/A	9 or 22 microns, e.g., 400-500 cm ⁻¹ centered at 22.2 microns (TIR spectrometer); 1064 nm or 1600 nm (lidar)	< 100 cm ⁻¹	N/A	N/A		
ATM-7	Thermal infrared spectrometer/radiometer - NIR spectrometer/lidar	Vertical profile of water ice opacity	Objectives I.A - I.B. - I.C.1. - II.B. Essential for monitoring of atmospheric state, water cycle, and collection of/comparison with long-term climatologies.	Per kilometer	10 ⁻⁶ -10 ⁻¹ km ⁻¹ (referenced to 1064 nm)	1-20%	0-80 km	< 5 km	PC	2 local times (2-3AM/PM)	1 h	180°W - 180°E	Instrument-dependent, ideally smaller than PP latitude resolution	85°S - 85°N	~1°	20 sols	0-360° Ls	1°-2° Ls	Radiance (TIR spectrometer); returned energy (lidar); polarization (lidar possible)	TIR: mW m ⁻² sr ⁻¹ (cm ⁻¹); Lidar: Photons/s/s; Polarization: dimensionless ratio	Instrument-dependent	Instrument-dependent	Instrument-dependent	Instrument-dependent	N/A	60 microrad (lidar)	N/A	N/A	12 microns, e.g. 820-870 cm ⁻¹ centered at 11.8 microns (TIR spectrometer); 1064 nm or 1600 nm (lidar)	< 100 cm ⁻¹	N/A	N/A		

Table B-4. MOSAIC Measurement Requirements.

ID	Instrument Type(s)	Physical Parameter (PP) Description	Link to Objectives	Units	Observable Quantity (OQ).																	Mass (where applicable)										
					PP Range	PP Resolution	PP Altitude Range	PP Altitude Resolution	PP Coordinate System	PP Local Time (LT) Range	PP LT Resolution	PP Longitude Range	PP Longitude Resolution	PP Latitude Range	PP Latitude Resolution	PP Cadence	PP Seasonal Range	PP Seasonal Resolution	Separate from physical parameter for remote data.					Angular FOV Azimuth (X) range	Azimuth (X) Resolution	Polar (Y) Range	Polar (Y) Resolution	Energy/Wavelength/Frequency Range	Resolution	Mass Range	Mass Resolution	
																			OQ Description	OQ Units	OQ Dynamic Range	OQ Precision	OQ SNR									OQ Time Resolution
ATM-8	Thermal infrared spectrometer/radiometer/lidar	Vertical profile of carbon dioxide ice opacity	Objectives I.A. - I.B. - I.C.1. - II.B. Essential for monitoring of atmospheric state, CO2 cycle, and collection of/comparison with long-term climatologies.	Per kilometer	10 ⁻⁶ -10 ⁻¹ km ⁻¹ (referenced to 1064 nm)	1-20%	0-80 km	< 5 km	PC	2 local times (2-3AM/PM)	1 h	180°W - 180°E	Instrument-dependent, ideally smaller than PP latitude resolution	85°S - 85°N	~1°	20 sols	0-360° Ls	1°-2° Ls	Radiance (TIR spectrometer); returned energy (lidar); polarization (lidar possible)	TIR: mW m ⁻² sr ⁻¹ (cm ⁻¹) ⁻¹ ; Lidar: Photons/s/s; Polarization: dimensionless ratio	Instrument-dependent	Instrument-dependent	Instrument-dependent	Instrument-dependent	N/A	60 microrad (lidar)	N/A	N/A	22 microns, e.g., 400-500 cm ⁻¹ centered at 22.2 microns (TIR spectrometer); 1064 nm or 1600 nm (lidar)	< 100 cm ⁻¹	N/A	N/A
ATM-9	Thermal infrared spectrometer - sub-mm sounder/lidar	Vertical profile of water vapor volume mixing ratio	Objectives I.A. - I.B. - I.C.1. - II.B. Never collected at comparable measurement density as temperature, water ice opacity. Essential for monitoring of atmospheric state, water cycle, and collection of/comparison with long-term climatology.	Dimensionless	0-2000 ppmv, Sub-mm: ~9 ppmv to 2000+ ppmv	10 ppmv, Sub-mm: < 9 ppm between the surface and 50 km altitude and < 20 ppm from 50-80 km altitude, with vertical resolution of < 3 km for a single profile. Averaging can improve precision.	0-80 km	5-10 km. Sub-mm: vertical resolution of < 3 km; vertical resolution tunable depending on goals; higher vertical resolution at cost of precision or longitudinal sampling.	PC	2 local times (2-3 a.m./p.m.)	1 h	180°W - 180°E	Instrument-dependent, ideally smaller than PP latitude resolution	85°S - 85°N. Sub-mm: 4° Depends on orbit	Sub-mm: Nominally	20 sols	0-360° Ls	1°-2° Ls. Sub-mm: depends on science goals; nominally acquiring data continuously	Radiance (sub-mm)	TIR: mW m ⁻² sr ⁻¹ (cm ⁻¹) ⁻¹ ; Sub-mm: W m ⁻² sr ⁻¹ GHz ⁻¹	Instrument-dependent	Sub-mm system T 1000 K	Instrument-dependent	Sub-mm: Variable; nominally scan 0-150 km in 75 sec to achieve precisions stated; slower scanning increases precision at the expense of latitudinal coverage.	Sub-mm: 2 antennas, each with 180° azimuth scanning capability	Sub-mm: Depends on goals; variable	N/A	N/A	2.6 microns (NIR with sunlight); 220-260 cm ⁻¹ (TIR); various frequencies between 0.1-1 mm (sub-mm)	< 100 cm ⁻¹	N/A	N/A
ATM-10	Thermal infrared or microwave spectrometer/radiometer	Surface temperature	Objectives I.A. - I.B. - II.B. Essential for monitoring of atmospheric state and collection of/comparison with long-term climatologies; mapping sub-surface ice	Kelvin	130-320 K	1 K	N/A	N/A	PC	2 local times (2-3 a.m./p.m.)	1 h	180°W - 180°E	Instrument-dependent, ideally smaller than PP latitude resolution	85°S - 85°N	1 km	20 sols	0-360° Ls	1°-2° Ls	Radiance	TIR: mW m ⁻² sr ⁻¹ (cm ⁻¹) ⁻¹ ; Microwave: W m ⁻² sr ⁻¹ GHz ⁻¹	Instrument-dependent	Instrument-dependent	Instrument-dependent	Instrument-dependent	Instrument-dependent	Instrument-dependent	N/A	N/A	290-340 cm ⁻¹ (TIR); anything broadband microwave or beyond 50 microns really	Instrument-dependent	N/A	N/A
ATM-11	Lidar (differential integration absorption lidar)/Near-infrared spectrometer	Surface pressure	Objectives I.B. - I.C.1. - II.B. Essential for monitoring of atmospheric state and collection of/comparison with long-term climatologies.	Pascals	150-1500 Pa	5%	N/A	N/A	PC	2-3 p.m. (differential absorption lidar would enable 2-3 AM as well)	1 h	180°W - 180°E	Instrument-dependent, ideally smaller than PP latitude resolution	85°S - 85°N	2 km	20 sols	0-360° Ls	1°-2° Ls	Radiance/returned energy (lidar)	Lidar: photon/s/s; NIR: W m ⁻² sr ⁻¹ nm ⁻¹	Instrument-dependent	Instrument-dependent	Instrument-dependent	Instrument-dependent	Instrument-dependent	Instrument-dependent	N/A	N/A	NIR: 1.8-2.2 microns; extrapolation from radiance ratios in TIR; CO2 line width near 1.6 microns (differential integrated absorption lidar)	Instrument-dependent	N/A	N/A

Table B-4. MOSAIC Measurement Requirements.

ID	Instrument Type(s)	Physical Parameter (PP) Description	Link to Objectives	Units	PP Range	PP Resolution	PP Altitude Range	PP Altitude Resolution	PP Coordinate System	PP Local Time (LT) Range	PP LT Resolution	PP Longitude Range	PP Longitude Resolution	PP Latitude Range	PP Latitude Resolution	PP Cadence	PP Seasonal Range	PP Seasonal Resolution	Observable Quantity (OQ).										Mass (where applicable)							
																			Separate from physical parameter for remote data.										Angular FOV (X) range	Azimuth (X) Resolution	Polar (Y) Range	Polar (Y) Resolution	Energy/Wavelength/Frequency Range	Resolution	Mass Range	Mass Resolution
																			OQ Description	OQ Units	OQ Dynamic Range	OQ Precision	OQ SNR	OQ Time Resolution												
DIU-1	Visible and/or UV imager	Extent of (dust/water ice) aerosol clouds	Objectives I.A. - I.B. - I.C.1. - II.B. Essential for direct visual monitoring of dust storms/water ice clouds/CO2 clouds morphology	Kilometers	5 km to global	5 km	N/A	N/A	PC	Daytime	0.5 h	180°W - 180°E	< 0.1°	80°S - 80°N	< 0.1°	30 minutes	0-360° Ls	<< 1° Ls	RGB values	Data Number (DN)	0-2047 (11 bit)	< 10% (VIS), < 20% (UV)	> 100 (VIS)	10-100 s msec (VIS), 1-10 s sec (UV)	22°	0.01°	22°	0.01°	400-750 nm (VIS)	± 50 nm for VIS, ± 24-30 nm for UV	N/A	N/A				
DIU-2	Visible and/or UV imager	Duration of (dust/water ice) aerosol clouds	Objectives I.A. - I.B. - I.C.1. - II.B. Essential for direct visual monitoring of dust storms/water ice clouds/ CO2 clouds evolution	Hours	Fraction of the hour to tens of sols	30 minutes	N/A	N/A	PC	Daytime	0.5 h	180°W - 180°E	< 0.1°	80°S - 80°N	< 0.1°	30 minutes	0-360° Ls	<< 1° Ls	RGB values	Data Number (DN)	0-2047 (11 bit)	< 10% (VIS), < 20% (UV)	> 100 (VIS)	10-100 s msec (VIS), 1-10 s sec (UV)	22°	0.01°	22°	0.01°	400-750 nm (VIS)	± 50 nm for VIS, ± 24-30 nm for UV	N/A	N/A				
DIU-3	Thermal infrared radiometer	Temperature	Objectives I.A. - I.B. - I.C.1. - II.B. Essential for monitoring of atmospheric state and collection of/comparison with long-term climatologies.	Kelvin	110-260 K	1 K	0-40 km	10 km	PC	0-24 h	0.5 h	180°W - 180°E	< 1°	60°S - 60°N	< 1°	30 minutes	0-360° Ls	<< 1° Ls	Radiance	mW m ⁻² sr ⁻¹ (cm ⁻¹) ⁻¹	0-90 mW m ⁻² sr ⁻¹ (cm ⁻¹) ⁻¹	1%	Variable	N/A	22°	0.05°	22°	0.05°	Around 15 microns	< 100 cm ⁻¹	N/A	N/A				
DIU-4	Thermal infrared spectrometer - NIR spectrometer	Dust column opacity	Objectives I.B. - I.C.1. - II.B. Essential for monitoring of atmospheric state and collection of/comparison with long-term climatologies.	Dimensionless	0-5, referenced to 1064 nm	10-20%	N/A	N/A	PC	0-24 h	0.5 h	180°W - 180°E	< 1°	60°S - 60°N	< 1°	30 minutes	0-360° Ls	<< 1° Ls	Radiance	TIR: mW m ⁻² sr ⁻¹ (cm ⁻¹) ⁻¹ ; NIR: W m ⁻² sr ⁻¹ nm ⁻¹	TIR: 0-90 mW m ⁻² sr ⁻¹ (cm ⁻¹) ⁻¹	1%	Variable	N/A	22°	0.05°	22°	0.05°	Around 9.3 or 22 microns, a broadband signal in NIR	10 nm for IR	N/A	N/A				
DIU-5	Thermal infrared spectrometer	Water ice column opacity	Objectives I.A. - I.B. - I.C.1. - II.B. Essential for monitoring of atmospheric state and collection of/comparison with long-term climatologies.	Dimensionless	0-5, referenced to 1064 nm	10-20%	N/A	N/A	PC	0-24 h	0.5 h	180°W - 180°E	< 1°	60°S - 60°N	< 1°	30 minutes	0-360° Ls	<< 1° Ls	Radiance	mW m ⁻² sr ⁻¹ (cm ⁻¹) ⁻¹	TIR: 0-90 mW m ⁻² sr ⁻¹ (cm ⁻¹) ⁻¹	1%	Variable	N/A	22°	0.05°	22°	0.05°	Around 11.8 micron, or NIR at 1254 nm or 1500 nm	10 nm for NIR	N/A	N/A				
DIU-6	Thermal infrared spectrometer	Carbon dioxide ice column opacity	Objectives I.A. - I.B. - I.C.1. - II.B. If possible, desirable for monitoring of atmospheric state and collection of/comparison with long-term climatologies.	Dimensionless	0-5, referenced to 1064 nm	10-20%	N/A	N/A	PC	0-24 h	0.5 h	180°W - 180°E	< 1°	60°S - 60°N	< 1°	30 minutes	0-360° Ls	<< 1° Ls	Radiance	mW m ⁻² sr ⁻¹ (cm ⁻¹) ⁻¹	TIR: 0-90 mW m ⁻² sr ⁻¹ (cm ⁻¹) ⁻¹	1%	Variable	N/A	N/A	N/A	N/A	N/A	N/A	Around 22 microns, or NIR at 1428 nm	10 nm for NIR	N/A	N/A			
DIU-7	NIR spectrometer	Surface pressure	Objectives I.A. - I.B. - I.C.1. - II.B. If possible, desirable for monitoring of atmospheric state and collection of/comparison with long-term climatologies.	Pascals	150-1500 Pa	5-10 Pa	N/A	N/A	PC	0-24 h	0.5 h	180°W - 180°E	< 1°	60°S - 60°N	< 1°	30 minutes	0-360° Ls	<< 1° Ls	Radiance (I/F)	W m ⁻² sr ⁻¹ nm ⁻¹ (dimensionless for I/F)	0-0.01 W m ⁻² sr ⁻¹ nm ⁻¹ (0-1)	< 2%	> 400	N/A	N/A	N/A	N/A	N/A	N/A	1800-2200 nm, centered at 2007 nm	10 nm	N/A	N/A			
DIU-8	NIR spectrometer/Thermal infrared spectrometer	Water vapor column abundance	Objectives I.A. - I.B. - I.C.1. - II.B. If possible, desirable for monitoring of atmospheric state and collection of/comparison with long-term climatologies.	Precipitable microns	5-400 μm	10-20%	N/A	N/A	PC	0-24 h	0.5 h	180°W - 180°E	< 0.25°	60°S - 60°N	< 1°	30 minutes	0-360° Ls	<< 1° Ls	Radiance	TIR: mW m ⁻² sr ⁻¹ (cm ⁻¹) ⁻¹ ; NIR: W m ⁻² sr ⁻¹ nm ⁻¹	Instrument-dependent	Instrument-dependent	Instrument-dependent	Instrument-dependent	N/A	N/A	N/A	N/A	Near 2602 nm (NIR); or 220-260 cm ⁻¹ with ~240 cm ⁻¹ as continuum	10 nm	N/A	N/A				

Table B-4. MOSAIC Measurement Requirements.

ID	Instrument Type(s)	Physical Parameter (PP) Description	Link to Objectives	Units	PP Range	PP Res-olution	PP Altitude Range	PP Altitude Res-olution	PP Coord-inate System	PP Local Time (LT) Range	PP LT Res-olution	PP Long-itude Range	PP Long-itude Res-olution	PP Latitude Range	PP Latitude Res-olution	PP Cadence	PP Seasonal Range	PP Seasonal Res-olution	Observable Quantity (OQ).										Mass (where applicable)							
																			Separate from physical parameter for remote data.										Angular FOV (X) range	Azimuth (X) Resolution	Polar (Y) Range	Polar (Y) Res-olution	Energy/Wavelength/Frequency Range	Resolution	Mass Range	Mass Res-olution
																			OQ Description	OQ Units	OQ Dynamic Range	OQ Preciso-n	OQ SNR	OQ Time Resolution												
DIU-9	Thermal infrared spectrometer/radiometer	Vertical profile of temperature	Objectives I.B. - I.C.1. - II.B. Essential for monitoring of atmospheric state and collection of/comparison with long-term climatologies.	Kelvin	110-260 K	1-2 K	0-80 km	5 km	PC	0-24 h	3 h	180°W - 180°E	45°	85°S - 85°N	2°	30 minutes	0-360° Ls	5° Ls	Radiance	mW m ⁻² sr ⁻¹ (cm ⁻¹) ⁻¹	0-90 mW m ⁻² sr ⁻¹ (cm ⁻¹) ⁻¹	1%	NER < 0.12 mW m ⁻² sr ⁻¹ / cm ⁻¹	10 s integration	270°	0.1°	270°	0.1°	15 micron CO ₂ band	20 to 30 cm ⁻¹ channels	N/A	N/A				
DIU-10	Thermal infrared spectrometer/radiometer - NIR radiometer	Vertical profile of dust opacity	Objectives I.B. - I.C.1. - II.B. Essential for monitoring of atmospheric state and collection of/comparison with long-term climatologies.	Per kilometer	10 ⁻⁶ km ⁻¹ - 2*10 ⁻² km ⁻¹ referenced to 1064 nm	10-20%	0-80 km	5-10 km	PC	0-24 h	3 h	180°W - 180°E	45°	85°S - 85°N	2°	1 sol	0-360° Ls	5° Ls	Radiance	TIR: mW m ⁻² sr ⁻¹ (cm ⁻¹) ⁻¹ ; NIR: W m ⁻² sr ⁻¹ nm ⁻¹	0-90 mW m ⁻² sr ⁻¹ (cm ⁻¹) ⁻¹	1%	NER < 0.1 mW m ⁻² sr ⁻¹ / cm ⁻¹	10 s integration	270°	0.1°	270°	0.1°	9 or 22 microns, e.g., 400-500 cm ⁻¹ centered at 22.2 microns (TIR spectrometer); 1064 nm or 1600 nm (lidar)	~50 and 100 cm ⁻¹ channels	N/A	N/A				
DIU-11	Thermal infrared spectrometer/radiometer - NIR radiometer	Vertical profile of water ice opacity	Objectives I.A. - I.B. - I.C.1. - II.B. Essential for monitoring of atmospheric state and collection of/comparison with long-term climatologies.	Per kilometer	10 ⁻⁶ km ⁻¹ - 2*10 ⁻² km ⁻¹ referenced to 1064 nm	10-20%	0-80 km	5-10 km	PC	0-24 h	3 h	180°W - 180°E	45°	85°S - 85°N	2°	1 sol	0-360° Ls	5° Ls	Radiance	TIR: mW m ⁻² sr ⁻¹ (cm ⁻¹) ⁻¹ ; NIR: W m ⁻² sr ⁻¹ nm ⁻¹	0-90 mW m ⁻² sr ⁻¹ (cm ⁻¹) ⁻¹	1%	NER < 0.1 mW m ⁻² sr ⁻¹ / cm ⁻¹	10 s integration	270°	0.1°	270°	0.1°	12 microns, e.g. 820-870 cm ⁻¹ centered at 11.8 microns	~50 cm ⁻¹ channel	N/A	N/A				
DIU-12	Thermal infrared spectrometer/radiometer - NIR radiometer	Vertical profile of carbon dioxide ice opacity	Objectives I.A. - I.B. - I.C.1. - II.B. Essential for monitoring of atmospheric state and collection of/comparison with long-term climatologies.	Per kilometer	10 ⁻⁶ km ⁻¹ - 2*10 ⁻² km ⁻¹ referenced to 1064 nm	10-20%	0-80 km	5-10 km	PC	0-24 h	3 h	180°W - 180°E	45°	85°S - 85°N	2°	1 sol	0-360° Ls	5° Ls	Radiance	TIR: mW m ⁻² sr ⁻¹ (cm ⁻¹) ⁻¹ ; NIR: W m ⁻² sr ⁻¹ nm ⁻¹	0-90 mW m ⁻² sr ⁻¹ (cm ⁻¹) ⁻¹	1%	NER < 0.1 mW m ⁻² sr ⁻¹ / cm ⁻¹	10 s integration	270°	0.1°	270°	0.1°	22 microns, e.g., 400-500 cm ⁻¹ centered at 22.2 microns	~100 cm ⁻¹ channels	N/A	N/A				
DIU-13	Thermal infrared spectrometer/radiometer	Vertical profile of water vapor volume mixing ratio	Objectives I.A. - I.B. - I.C.1. - II.B. Never collected at comparable measurement density as temperature, water ice opacity. Essential for monitoring of atmospheric state, water cycle, and collection of/comparison with long-term climatology.	Parts per million	0-2000 ppmv	10 ppmv	0-80 km	5-10 km	PC	0-24 h	3 h	180°W - 180°E	45°	85°S - 85°N	2°	1 sol	0-360° Ls	5° Ls	Radiance	mW m ⁻² sr ⁻¹ (cm ⁻¹) ⁻¹	0-90 mW m ⁻² sr ⁻¹ (cm ⁻¹) ⁻¹	1%	NER < 0.1 mW m ⁻² sr ⁻¹ / cm ⁻¹ (wideband) NER < 0.3 mW m ⁻² sr ⁻¹ / cm ⁻¹ (narrow channel)	10 s integration	270°	0.1°	270°	0.1°	220-260 cm ⁻¹	40 cm ⁻¹ and 12 cm ⁻¹ channels	N/A	N/A				
DIU-14	Thermal infrared spectrometer/radiometer	Surface temperature	Objectives I.A - I.B. - II.B. Essential for monitoring of atmospheric state and collection of/comparison with long-term climatologies.	Kelvin	130-320 K	1 K	N/A	N/A	PC	0-24 h	3 h	180°W - 180°E	45°	85°S - 85°N	<0.02°	1 sol	0-360° Ls	5° Ls	Radiance	mW m ⁻² sr ⁻¹ (cm ⁻¹) ⁻¹	0-90 mW m ⁻² sr ⁻¹ (cm ⁻¹) ⁻¹	1%	NER < 0.17 mW m ⁻² sr ⁻¹ / cm ⁻¹	4 s integration	270°	0.1°	270°	0.1°	290-340 cm ⁻¹ ; or beyond 50 microns really	50 cm ⁻¹ channel	N/A	N/A				
DIU-15	Visible and/or UV imager	U, V wind, also dust storm and cloud structure and evolution	Objectives I.A. - I.B. - I.C.1. - II.B. Essential for direct visual monitoring of dust storms/water	Meters per second	0-200 m/s	10 m/s	depends on features; possibly up to 80 km (see	~10 km, depends on coordinate obs.	PC	Daylight hours	1 h	180°W - 180°E	<0.1°	80°S - 80°N	< 0.1°	1 sol	0-360° Ls	<< 1° Ls	Change in feature position	km	N/A	N/A	N/A	N/A	22°	0.01°	22°	0.01°	200-700 nm	100 nm	N/A	N/A				

Table B-4. MOSAIC Measurement Requirements.

ID	Instrument Type(s)	Physical Parameter (PP) Description	Link to Objectives	Units	PP Range	PP Res-olution	PP Altitude Range	PP Altitude Res-olution	PP Coord-inate System	PP Local Time (LT) Range	PP LT Res-olution	PP Long-itude Range	PP Long-itude Res-olution	PP Latitude Range	PP Latitude Res-olution	PP Cadence	PP Seasonal Range	PP Seasonal Res-olution	Observable Quantity (OQ).										Mass (where applicable)							
																			Separate from physical parameter for remote data.										Angular FOV (X) range	Azimuth (X) Resolution	Polar (Y) Range	Polar (Y) Res-olution	Energy/ Wavelength/ Frequency Range	Resolution	Mass Range	Mass Res-olution
																			OQ Description	OQ Units	OQ Dynamic Range	OQ Precision	OQ SNR	OQ Time Resolution												
IONO-2	Langmuir probe	Electron density	Obj I.C.2	Per cubic centimeter	200-1E4 cm ⁻³	2E2 cm ⁻³	200-800 km	5 km	MSO	0-24 h	1 h	0-360°	15°	90°S to 90°N	10°	20 vertical profiles per sol for 1 Mars year (widely dispersed in MSO lat/lon)	0-360° Ls	Daily	N/A: same as physical parameter	N/A: same as physical parameter	N/A: same as physical parameter	N/A: same as physical parameter	N/A: same as physical parameter	N/A: same as physical parameter	N/A	N/A	N/A	N/A	N/A	N/A	N/A	N/A	N/A			
IONO-4	Spacecraft-to-spacecraft radio occultation	Electron density irregularities - Search for electron density irregularities with length-scale > 10 km and magnitude > 1000 cm ⁻³	Obj II.C	Dimensionless	N/A	N/A	100-200 km	5 km	MSO	0-24 h	1 h	60-120°, 240-300°	15°	90°S to 90°N	10°	20 measurements per sol for 1 Mars year, widely dispersed in MSO latitude and at MSO longitudes 60-120° or 240-300°	0-360° Ls	Daily	Received radio power	Watts	Implementation dependent	Few %	Few %	1 second	N/A	N/A	N/A	N/A	Appropriate band (e.g., UHF, S, X, Ka) needs to be selected	N/A	N/A	N/A	N/A			
EXO-1	UV Spectrometer	Escape rate/exospheric inventory of H	Measure loss rate of H as a function of solar and lower atmospheric drivers	Escaping atmospheric flux	1-100 x 10 ⁷ H lost / cm ² / s	~50%	100-1000 km	15km	MSO	Global	~6 h	all	~90°	all	~45°	~daily	all	~daily	Lyman alpha brightness	Rayleighs	1-20 kR	1%	100	~daily for one set of planetary images	< 2°	< 2°	> 10°	0.5°	121-123 nm	1.5 nm	N/A	N/A				
MAGN-1	Fluxgate mag	Vector magnetic field	Obj I.C Obj I.D	nanoTesla	~1 to 3000 nT	0.3 nT or 10%	200+ km	NA	MSO	0-24 h	NA	0-360°	NA	90°S to 90°N	NA	64 Hz	0-360° Ls	NA	N/A: same as physical parameter	N/A: same as physical parameter	N/A: same as physical parameter	N/A: same as physical parameter	N/A: same as physical parameter	N/A: same as physical parameter	N/A	N/A	N/A	N/A	N/A	N/A	N/A	N/A				
MAGN-2	Electron energy/angle analyzer	Suprathermal electron flux	Obj I.C Obj I.D	eV per square centimeter per second per steradian per eV	1E4 to 1E10 eV/(cm ² -s-ster-eV)	10%	200+ km	NA	MSO, MSE	0-24 h	N/A	0-360°	N/A	90°S to 90°N	N/A	16 sec	0-360° Ls	N/A	N/A: same as physical parameter	N/A: same as physical parameter	N/A: same as physical parameter	N/A: same as physical parameter	N/A: same as physical parameter	N/A: same as physical parameter	0-360°	30°	-90 to +90°	30°	~1 eV to 10 keV	20% (dE/E)	N/A	N/A				
MAGN-5	Ion energy/angle/mass analyzer	Mass-separated Suprathermal Ion flux	Obj I.C Obj I.D	eV per square centimeter per second per steradian per eV	1E7 to 1E10 (dt~16 sec) 1E4 to 1E8 (dt~10 min)	10%	200+ km	NA	MSO, MSE	0-24 h	N/A	0-360°	N/A	90°S to 90°N	N/A	16 sec	0-360° Ls	N/A	N/A: same as physical parameter	N/A: same as physical parameter	N/A: same as physical parameter	N/A: same as physical parameter	N/A: same as physical parameter	N/A: same as physical parameter	0-360°	30°	-90 to +90°	30°	~1 eV to 20 keV	25% (dE/E)	1 to 44 amu	> 2				
MAGN-12	Electric fields/waves	Vector electric field	Obj I.C Obj I.D	millivolts per meter	-300 to +300 mV/m (DC) - 100 to +100 mV/m (AC)	0.009 mV/m (DC) 0.003 mV/m (AC)	200+ km	NA	MSO, MSE	0-24 h	N/A	0-360°	N/A	90°S to 90°N	N/A	2-16 samples/sec	0-360° Ls	N/A	N/A: same as physical parameter	N/A: same as physical parameter	N/A: same as physical parameter	N/A: same as physical parameter	N/A: same as physical parameter	N/A: same as physical parameter	N/A	N/A	N/A	N/A	N/A	N/A	N/A	N/A	N/A			
MAGN-13	Electric fields/waves	Electric field wave power	Obj I.C Obj I.D	millivolts per meter per root Hertz	1E-4 to 1E2 mV/m/sqrt(Hz)	1E-4 mV/m/sqrt(Hz) @ 10 Hz	200+ km	NA	MSO, MSE	0-24 h	N/A	0-360°	N/A	90°S to 90°N	N/A	100 samples/sec w/ burst	0-360° Ls	N/A	N/A: same as physical parameter	N/A: same as physical parameter	N/A: same as physical parameter	N/A: same as physical parameter	N/A: same as physical parameter	N/A: same as physical parameter	N/A	N/A	N/A	N/A	DC to 8 Hz	N/A	N/A	N/A	N/A			
MAGN-14	Magnetic fields/waves	Magnetic field wave power	Obj I.C Obj I.D	nT per root Hertz	1E-4 to 1 nT/sqrt(Hz)	1E-4 nT/sqrt(Hz) @ 10 Hz	200+ km	NA	MSO, MSE	0-24 h	N/A	0-360°	N/A	90°S to 90°N	N/A	100 samples/sec w/ burst	0-360° Ls	N/A	N/A: same as physical parameter	N/A: same as physical parameter	N/A: same as physical parameter	N/A: same as physical parameter	N/A: same as physical parameter	N/A: same as physical parameter	N/A	N/A	N/A	N/A	1 Hz to 4 kHz	N/A	N/A	N/A	N/A			

Table B-4. MOSAIC Measurement Requirements.

ID	Instrument Type(s)	Physical Parameter (PP) Description	Link to Objectives	Units	PP Range	PP Res-olution	PP Altitude Range	PP Altitude Res-olution	PP Coord-inate System	PP Local Time (LT) Range	PP LT Res-olution	PP Long-itude Range	PP Long-itude Res-olution	PP Latitude Range	PP Latitude Res-olution	PP Cadence	PP Seasonal Range	PP Seasonal Res-olution	Observable Quantity (OQ). Separate from physical parameter for remote data.							Angular FOV (X) range	Azimuth (X) Resolution	Polar (Y) Range	Polar (Y) Res-olution	Energy/Wavelength/Frequency Range	Resolution	Mass (where applicable)	
																			OQ Description	OQ Units	OQ Dynamic Range	OQ Precision	OQ SNR	OQ Time Resolution	Mass Range							Mass Res-olution	
SPA-1	Solar EUV monitor	Solar EUV spectral irradiance	Obj 1.D8	Watts per square meter per nanometer	1E-6 to 3E-2 W/m ² /nm	15% (dI/I)	> 2000 km (upstream solar wind)	N/A	N/A	N/A	N/A	N/A	N/A	N/A	N/A	16 sec	0-360° Ls	N/A	N/A: same as physical parameter	N/A: same as physical parameter	N/A: same as physical parameter	N/A: same as physical parameter	N/A: same as physical parameter	N/A: same as physical parameter	-2 to +2°, centered on Sun	N/A	-2 to +2°, centered on Sun	N/A	10-20 nm, 17-22 nm, 121.6 nm	N/A	N/A	N/A	
SPA-2	Fluxgate mag	Vector magnetic field	Obj 1.D8	nanoTesla	~1 to 3000 nT	0.3 nT or 10%	> 2000 km (upstream solar wind)	NA	MSO, MSE	N/A	NA	N/A	N/A	N/A	N/A	64 Hz	0-360° Ls	N/A	N/A: same as physical parameter	N/A: same as physical parameter	N/A: same as physical parameter	N/A: same as physical parameter	N/A: same as physical parameter	N/A: same as physical parameter	N/A	N/A	N/A	N/A	N/A	N/A	N/A	N/A	
SPA-3	Ion energy/angle analyzer	Ion flux	Obj 1.D8	eV per square centimeter per second per steradian per eV	1E7 to 1E10 eV/(cm ² -s-st-eV)	10%	> 2000 km (upstream solar wind)	N/A	MSO, MSE	N/A	N/A	N/A	N/A	N/A	16 sec	0-360° Ls	N/A	N/A: same as physical parameter	N/A: same as physical parameter	N/A: same as physical parameter	N/A: same as physical parameter	N/A: same as physical parameter	N/A: same as physical parameter	-20 to +20°, centered on Sun	10°	-20 to +20°, centered on Sun	10°	~50 eV to 10 keV	15% (dE/E)	N/A	N/A		
SPA-6	Electron energy/angle analyzer	Suprathermal electron flux	Obj 1.D8	eV per square centimeter per second per steradian per eV	1E4 to 1E10 eV/(cm ² -s-st-eV)	10%	> 2000 km (upstream solar wind)	N/A	MSO, MSE	0-24 h	N/A	0-360°	N/A	90°S to 90°N	N/A	16 sec	0-360° Ls	N/A	N/A: same as physical parameter	N/A: same as physical parameter	N/A: same as physical parameter	N/A: same as physical parameter	N/A: same as physical parameter	N/A: same as physical parameter	0-360°	30°	-90 to +90°	30°	~1 eV to 10 keV	20% (dE/E)	N/A	N/A	
SPA-9	Energetic ion/electron detector	Ion/electron flux	Obj 1.D8	eV per square centimeter per second per steradian per eV	1E1 to 1E6 eV/(cm ² -s-st-eV)	10%	> 2000 km (upstream solar wind)	N/A	MSO, MSE	0-24 h	N/A	0-360°	N/A	90°S to 90°N	N/A	20 min	0-360° Ls	N/A	N/A: same as physical parameter	N/A: same as physical parameter	N/A: same as physical parameter	N/A: same as physical parameter	N/A: same as physical parameter	N/A: same as physical parameter	40 x 40° centered on +/- Parker spiral dirs	N/A	40 x 40° centered on +/- Parker spiral dirs	N/A	50 keV to 5 MeV	50% (dE/E)	N/A	N/A	

B.1.6 Instrument Requirements Table

Table B-5. Performance metrics of instruments considered for the MOSAIC payload.

Investigation	Description	Name	Platform	Measurements (Up to 4; please link to physical parameters)	Supplier	TRL	Time to TRL5	\$ to TRL5	Time TRL 5 to 6	\$ TRL 5 to 6	FOV	Mass	Power	Volume	Accommodation/Operational Requirement	Wavelength/Frequency/Energy/Field Range	Resolution/Number of channels	Bits Per Sample	Sample Rate	Threshold Data Rate (bps)	Baseline Data Rate (orbit-average bps)	A-D Cost (\$FY20)	Contributable?	Notes
ICE	Radar (P-band SAR)	POPSAR (polarimetric orbital p-band SAR)	Mothership	Surface backscatter Polarimetric backscatter Bulk dielectric permittivity	JPL	8	N/A	N/A	N/A	N/A	35-39° (based on Eagle)	125 kg (based on ESA Biomass)	200 W operational; 500 W peak	1.94 m ³ (Eagle)		400 MHz	30 m (HDR)/100 m (LDR)			800,000	1.50E+06	\$170M (estimate based on ESA Biomass)	Yes - Canada (already offered as part of COMPASS)	
ICE	UV-VIS-NIR Imager	Mars Atmosphere, Volatile, and Resource Investigation Camera (MAVRIC)	Mothership	Duration of (dust/water ice) aerosol clouds Water ice column opacity Carbon dioxide ice column opacity	JHU APL	7 except for detector array (TRL 5)	N/A	N/A	For detector array	For detector array	150°	0.97+2.42 kg electronics	2.1 W cameras, 8.2W electronics	10 cm x 7.5 x 14, 12 x 10 x 3.5 interface adapter		0.34-0.75 um, 1.1-1.6 um	6 channels between 0.34-0.75 um, 6 channels between 1.1-1.6 um			8.8 Gb/sol downlinked ~102 Kb/s collected orbit average	11 Gb/sol downlinked ~127 Kb/s collected orbit average	\$13M (without reserves)	Yes	
ATM	Lidar	MARLI	Mothership	Vertical profile of horizontal wind in its zonal and meridional components (U, V) Vertical profile of dust opacity Vertical profile of water ice opacity	GSFC	6 by 6/2020						38 kg	81 W	760 x 760 x 640 mm		1064 nm			50 kbits/s data rate	25 kbps threshold, 50 kbps baseline	50000	~\$40M	No	

Table B-5. Performance metrics of instruments considered for the MOSAIC payload.

Investigation	Description	Name	Platform	Measurements (Up to 4; please link to physical parameters)	Supplier	TRL	Time to TRL5	\$ to TRL5	Time TRL 5 to 6	\$ TRL 5 to 6	FOV	Mass	Power	Volume	Accommodation/Operational Requirement	Wavelength/Frequency/Field Range	Resolution/Number of channels	Bits Per Sample	Sample Rate	Threshold Data Rate (bps)	Baseline Data Rate (orbit-average bps)	A-D Cost (\$FY20)	Contributable?	Notes
ATM	Lidar	OPAL	Mothership	0-50 km or greater temperature Pressure, density (down to surface possible) Aerosol Opacity Wind velocity (u,v,w)	NASA Langley	3 (Developed under the IRAD program)	3 years	\$3M	2 years	\$5M	~0.1 mrad	40 kg	45-55 W	0.15 m ³ (MOLA)	N/A	1600 nm	25 MHz over 1 GHz wide spectral interval	5188-15564	3 s	5000	1730-5190; raw data of 1 sample per orbit would require: 139000	~\$70M	No	
ATM	Sub-mm sounder	Sub-mm sounder	Mothership	0-100 km temperature (incl. surface) Horizontal wind velocity Water vapor concentration	JPL	5 (Developed under the IRAD program); There is only one item needing testing; could be done with \$50K	N/A	N/A	3-6 months	\$50K		2-antenna: 35 kg; 1-fixed-antenna: 11.5 kg	2-antenna: 50 W (+20 for USO, if needed); 1-fixed-antenna: 15.6 W	2-antenna: 20x20x10 cm 2, 30 cm diam antennas; 1-fixed-antenna: 20x10x10 cm, 1 30 cm diam antenna		~450 GHz	3 GHz spectrometers; zoom to 300 MHz channels; tunable	10 kbps compressed (40 kbps raw)	Variable			2-antenna: ~\$35M (Discovery mission proposal); 1-antenna: ~\$25M (Delta from Discovery mission proposal)	No	
ATM	Thermal IR radiometer	Limb-nadir radiometer	Mothership	Vertical profile of temperature Vertical profile of dust opacity Vertical profile of water ice opacity Vertical profile of water vapor volume mixing ratio	JPL	9 (Equivalent to MRO/MCS)	N/A	N/A	N/A	N/A	FOV 70 mrad, IFOV 1.8 mrad	9 kg	18 W	Swept volume: 420 mm (cylindrical diameter) x 400 mm (height)		12-42 micron 0.3-3 microns	9 channels	8 kbits/sample	2 s		4000	~\$25M		
ATM/DIU	Thermal IR radiometer	Mini-MCS (limb-nadir)	SmallSats	Vertical profile of temperature Vertical profile of dust opacity Vertical profile of water ice opacity Vertical profile of water vapor volume mixing ratio	JPL	6 (Heritage from MCS subsystems, PREFIRE)	N/A	N/A	N/A	N/A	FOV 70 mrad, IFOV 1.8 mrad	3.5 kg	8 W	2U		12-42 micron, 0.3-3 micron	9 channels	8 kbits/sample	2 s		4000	~\$10M for first unit, ~\$5M for follow-on units		
ATM/DIU	Thermal IR imager	Thermal IR Imager (TIRI)	SmallSats	Temperature (0-40 km) Dust column opacity Water ice column opacity Water vapor column abundance	Oxford Physics	6 (Heritage from MIRMIS/Comet Interceptor and LTM/Lunar Trailblazer)	N/A	N/A	N/A	N/A	FOV: 9° x 7°; IFOV: 0.26	4.6 kg (5.6 with margin)	2.2 W standby, 4.5 W avg, 7.5 W peak	250 x 210 x 105 mm (~4U)	Scanning mechanism required to mosaic the full Martian disk at areostationary distance	6-25 microns with test programme in place to extend to 100 microns	Up to 12 spectral channels, typical spectral channel width 0.3	531 Mbit for full disk mosaic (without compression): 640 x 480 pixels x 16 bits x 9 frames x 12 channels, assuming all channels are swept equally. If compression needs to be included, guide number by RAL Space is a 0.6 compression factor.	Typical: 1 frame/15 minutes	73.7 Mbit/s (0.5 over 24 h)	295 Mbit/s (2 image/h over 24 h)	ROM ~\$8M, based on an upgraded version of the Lunar Trailblazer instrument for enhanced radiation-hardening		Currently testing the long wave response of the 640 x 480 detector array and considering other manufacturers for the long wave/low temperature channels. In theory TIRI can get to similar wavelengths as MCS for water vapor. The spatial resolution at longer wavelength will be worse due to the telescope's diffraction limit.
DIU	Thermal IR radiometer / spectrometer	Mini-MCS/PREFIRE (nadir)	SmallSats	Vertical profile of temperature Dust column opacity Water ice column opacity Water vapor column abundance	JPL	6 (Heritage from MCS subsystems, PREFIRE)	N/A	N/A	N/A	N/A	FOV 70 mrad, IFOV 1.8 mrad	3.5 kg	8 W	2U		12-42 micron, 0.3-3 micron	9 channels	8 kbits/sample	2 s			~\$10M for first unit, ~\$5M for follow-on units		

Table B-5. Performance metrics of instruments considered for the MOSAIC payload.

Investigation	Description	Name	Platform	Measurements (Up to 4; please link to physical parameters)				Supplier	TRL	Time to TRL5	\$ to TRL5	Time TRL 5 to 6	\$ TRL 5 to 6	FOV	Mass	Power	Volume	Accommodation/Operational Requirement	Wavelength/Frequency/Field Range	Resolution/Number of channels	Bits Per Sample	Sample Rate	Threshold Data Rate (bps)	Baseline Data Rate (orbit-average bps)	A-D Cost (\$FY20)	Contributable?	Notes
				Extent of (dust/water ice) aerosol clouds	Duration of (dust/water ice) aerosol clouds	Dust column opacity	Water ice column opacity																				
DIU	VIS camera	ECAM-C50	SmallSats	Extent of (dust/water ice) aerosol clouds	Duration of (dust/water ice) aerosol clouds			MSSS	9	N/A	N/A	N/A	N/A	FOV: 29° x 22°; IFOV: 0.2 mrad	500 g	<2.5 W	58 (L) x 78 (W) x 130 (H) mm	With this FOV, it look at the full disk at areos altitude, so it works better if spacecraft does not slew	RGB (400-500 nm, 500-575 nm, 575-750 nm)	3	53 Mbit (compressed)	Easily 1 frame/15 minutes or more	7.4 Mbit/s (0.5 image/h over 12h)	29.4 Mbit/s (2 image/h over 12 h)	\$0.5M		This camera at the moment requires a digital video recorder/data storage (157 (L) x 183 (W) x 32 (H) mm, 1110 g). Cabling mass: 0.3 kg
DIU	Thermal IR Imager	Thermal IR Imager	SmallSats	Temperature	Dust column opacity	Water ice column opacity	Surface temperature	MSSS	6 (Heritage from ECAM-IR3A)	N/A	N/A	N/A	N/A	FOV: 29° x 22°; IFOV: 0.81 mrad	1.4 kg each camera (of a set of two)	<7 W	108 (L) x 91 (W) x 130 (H) mm each camera (of a set of two)	With this FOV, it look at the full disk at areos altitude, so it works better if spacecraft does not slew. It might require pixel summing to increase SNR.	7.9 to 16 microns	6	13 Mbit (without pixel summing, but with compression)	Easily 1 frame/15 minutes or more	1.8 Mbit/s (0.5 image/h over 24h)	7.2 Mbit/s (2 image/h over 24 h)	\$5.0M		Two cameras are required to cover the 7.9 to 16 microns spectral range. These two cameras at the moment require a digital video recorder/data storage (157 (L) x 183 (W) x 32 (H) mm, 1110 g) as for the MSSS-VIS camera. Cabling mass: 0.3 kg
DIU	NIR spectrometer with integrated optics	Argus 1000 Spectrometer	SmallSats	Surface pressure	Dust column opacity	Water ice column opacity	Water vapor column opacity	Thoth Techn.	9 (Flew on CanX-2)	N/A	N/A	N/A	N/A	FOV: 0.15°	300 g	<2.5 W	45 x 50 x 80 mm	N/A	1000 nm to 1700 nm, up to 2400 nm in the extended rand version	100 channels (~6 nm resolution typical)	4288	0.5-4096 ms	1057 bps for Areostationary, 7873 bps for Polar and Mothership	1057 bps for Areostationary, 7873 bps for Polar and Mothership	\$340K		
DIU	High resolution Multispectral or Hyperspectral imager (VIS-NIR)	Chameleon Imager	SmallSats	Weather context imagery in RGB-NIR (PAN+MS)				Space Advisory	6 (Heritage from Gecko subsystem)	N/A	N/A	N/A	N/A	5.6° FOV; IFOV=0.012-0.024 mrad	1.6 kg	<7 W	200 x 94 x 94 mm (2U)	If at areostationary, it requires some scanning to cover full Martian disk	Visible	11 channels (PAN+MS)	~2Gb	12.5 frames/15 minutes	30 million bps	\$628K			
DIU	RGB or multispectral imager	Gecko Imager	SmallSats	Weather context imagery- RGB (PAN+MS)				SCS & Space Advisory	9 (Flew on n-Sight-1 Earth observation satellite)	N/A	N/A	N/A	N/A	9.2° FOV; IFOV=0.08 mrad	500 g	<3.5 W	58 mm x 97 mm x 96 mm (1U)	If at areostationary, it requires some scanning to cover full Martian disk	Visible		450 kB-3 MB	5 frames/s -5 frames/15 minutes	5000 (5x450 kb images per hour)	30 kbps	\$100K		
DIU	Radio occultation with directional antenna	TX/RX radio	Mothership and SmallSats	Vertical profile of temperature	Vertical profile of pressure	Geopotential height (geostrophic winds)		JPL	> 6 (based on the IRIS radio with modifications for SmallSats and UST for large orbiter)	N/A	N/A	N/A	N/A	Antenna boresight in velocity and anti-velocity direction: +/- 60° in azimuth, +/- 10° in elevation	1.45 kg (IRIS)	<33 W (IRIS)	10 cm x 10 cm x 5 cm (IRIS)		Objective: S/X dual-bands; threshold: X-band		16 (I and Q, 8 bits each)	1 kHz					
DIU	UV-VIS-NIR Imager	Mars Atmosphere, Volatile, and Resource Investigation Camera (MAVRIC)	Mothership, SmallSats	Duration of (dust/water ice) aerosol clouds	Water ice column opacity	Carbon dioxide ice column opacity		JHU APL	7 except for detector array (TRL 5)	N/A	N/A	TBD	TBD	150°	0.97+2.42 kg electronics	2.1 W cameras, 8.2W electronics	10 cm x 7.5 x 14, 12 x 10 x 3.5 interface adapter		0.34-0.75 um, 1.1-1.6 um	6 channels between 0.34-0.75 um, 6 channels between 1.1-1.6 um			8.8 Gb/sol downlinked ~102 Kb/s collected orbit average	11 Gb/sol downlinked ~127Kb/s collected orbit average	\$13M (without reserves)		

Table B-5. Performance metrics of instruments considered for the MOSAIC payload.

Investigation	Description	Name	Platform	Measurements (Up to 4; please link to physical parameters)	Supplier	TRL	Time to TRL5	\$ to TRL5	Time TRL 5 to 6	\$ TRL 5 to 6	FOV	Mass	Power	Volume	Accommodation/Operational Requirement	Wavelength/Frequency/Energy/Field Range	Resolution/Number of channels	Bits Per Sample	Sample Rate	Threshold Data Rate (bps)	Baseline Data Rate (orbit-average bps)	A-D Cost (\$FY20)	Contributable?	Notes
THER	FUV/MUV spectrograph	IUVS	Mothership	Altitude profiles of O ₂ thermospheric density Thermospheric temperature profiles Composition (CO ₂ , O as primary target, NO nighttime as secondary goal)	LASP/SWRI	9	N/A	N/A	N/A	N/A	Limb (needs accurate limb tracking)	27 kg	28 W		Limb viewing, 50-250 km tangent altitude	FUV:134-165nm MUV:190-300nm	FUV: 1.5 nm, MUV: 2 nm	FUV: 10 Kb, MUV: 20 Kb	40 integrations for FUV + MUV every 3 minutes	5 kbps	8 kbps	\$30M ROM		
THER	EUV/FUV spectrograph	EMM EMUS	Mothership or Areostationary	Altitude profiles of O ₂ thermospheric density Thermospheric temperature profiles	LASP/SWRI	9	N/A	N/A	N/A	N/A	Limb (needs accurate limb tracking)	15 kg	15 W											
THER	Interferometer	ICON MIGHTI	Mothership	Horizontal Wind	NRL	9	N/A	N/A	9 months	\$3M	Limb (needs accurate limb tracking)	40 kg	13 W		Limb view, 45 and 135° to ram, baffle to exclude planet, pointing control to keep FOV away from lower atmosphere, sun etc.	557.7 nm and 1.27 um	2 channels, each with 2 wavelengths, and 50 altitude elements	\$1.26M	2 exposures per channel every 3 minutes	10 kbps	14 kbps orbit av	\$40M (without reserves)		
IONO	Spacecraft-to-spacecraft radio occultation	Spacecraft-to-spacecraft radio occultation	All	Electron density	JPL	5	N/A	N/A	3 years	\$3M	Antenna boresight in velocity and anti-velocity direction: +/- 60° in azimuth, +/- 10° in elevation	1.45 kg (IRIS)	<33 W (IRIS)	10 cm x 10 cm x 5 cm (IRIS)	TBD	UHF/L/S-band (dual-freq desirable)	N/A	16 (I and Q, 8 bits each)	1 kHz (plus scintillation data at 1 Hz)	11000	\$2M	No	16 bits per sample, 1 kHz rate, 10 min duration = 1E7 bits per observation. 100 observations per sol = 1E9 bits per sol = 11000 bits per second. Some kind of onboard data processing would reduce this greatly, if feasible	
IONO	Multi-Needle Langmuir probe (only one of this or Planar ion probe is required)	Langmuir probe	Elliptical	Electron density	Embry-Riddle	6	N/A	N/A	N/A	N/A	N/A	0.25 kg	<1 W	Needles are tiny. Electronics is a single small board	Must be on a boom more than 0.5 m from the spacecraft body.	N/A	N/A	112, uncompressed	1 sample per second	10	10	\$0.5M	No	Assume data collected for 20 minutes in every 4 hour orbit
IONO	Planar ion probe which measures Ni-total, assumed to equal Ne (only one of this or multi-Needle Langmuir probe is required)	Pseudo-Langmuir probe	Elliptical	Electron density	Embry-Riddle	6	N/A	N/A	N/A	N/A	N/A	0.20 kg	<0.5 W	PIP is a flat gold panel on the side of the spacecraft. Electronics is a single small board	Needs 20 cm x 20 cm surface area to put as patch sensor	N/A	N/A	32, uncompressed	1 sample per second	10	10	\$0.5M	No	Assume data collected for 20 minutes in every 4 hour orbit
EXO	EUV/FUV spectrograph		Mothership	Coronal brightness profiles of O Coronal brightness profiles of H	LASP/SWRI	9	N/A	N/A	N/A	N/A	Along Mars-Sun line up to 5 Mars radii	20 kg	20 W	60 x 25 x 15 cm		100-140 nm	~1 nm	Depends, instrument is highly configurable	Highly dependent on ConOps, estimated total data rate	~500 Mbit/week, ~1kbps	~4kbps	\$20M	No	

Table B-5. Performance metrics of instruments considered for the MOSAIC payload.

Investigation	Description	Name	Platform	Measurements (Up to 4; please link to physical parameters)			Supplier	TRL	Time to TRL5	\$ to TRL5	Time TRL 5 to 6	\$ TRL 5 to 6	FOV	Mass	Power	Volume	Accommodation/ Operational Requirement	Wavelength/ Frequency/ Energy/ Field Range	Resolution/ Number of channels	Bits Per Sample	Sample Rate	Threshold Data Rate (bps)	Baseline Data Rate (orbit-average bps)	A-D Cost (\$FY20)	Contributable?	Notes
MAGN	Small fluxgate mag	Fluxgate mag	Elliptical, L1, High elliptical	Magnetic field vectors			GSFC, UCLA	9	N/A	N/A	N/A	N/A	< 1 kg	< 1 W	Sensor: ~1 cm x 1 cm x 1 cm Electronics: ~8 cm x 8 cm x 1 cm	Mag cleanliness	N/A	N/A	48	~6 kbps assuming 128 samples/sec	200	800	~\$4M	Japan, Germany		
MAGN	Ion electrostatic analyzer with mass discrimination	Ion ESA-TOF	Elliptical	Ion moments (density, temperature, velocity), separated by mass	Ion velocity distribution functions, separated by mass		SSL	9	N/A	N/A	N/A	360 x 90° (3-axis but could be adapted to spinner)	2.8 kg	3.7 W	26 x 14 x 14 cm	Electrostatic cleanliness, clear FOV	N/A	N/A	2 kb	16 seconds	1000	2000	~\$4M	Sweden, France		
MAGN	Electron electrostatic analyzer	Electron ESA	Elliptical	Electron moments (density, temperature) in the solar wind/magnetosheath	Electron energy/pitch angle distributions	Electron energy/flux distributions	SSL, SwRI	9	N/A	N/A	N/A	360 x 120° (3-axis but could be adapted to spinner)	1.6 kg	1 W	20 x 16 x 16 cm	Electrostatic cleanliness, onboard pitch angle sorting, clear FOV	N/A	N/A	160	1 sample per 4 seconds	500	1000	~\$3M	France		
MAGN	Electric field and waves	Electric field antennas	Elliptical	Vector electric field	Electric field wave power		SSL	9	N/A	N/A	N/A	N/A (must be booms spinner)	12 kg (6 booms)	0.24 W	8-cm-diameter spheres	Spinning, electrostatically clean spacecraft	DC to 300 kHz	up to 8192	16	4 samples per second	500	1000	~\$2M		Reflight of THEMIS EFI	
MAGN	Magnetic waves	Search coil magnetometer	Elliptical	Magnetic field wave power			CETP, France Univ. Iowa	9	N/A	N/A	N/A	omnidirectional	1.8 kg (1 boom)	0.08 W	3 orthogonal 18-cm-long rods on a 1-m boom	Magnetic cleanliness (dynamic)	0.1 Hz to 4 kHz	up to 8192	16	4 samples per second	200	800	~\$3M (incl. boom)		Reflight of THEMIS SCM	
SPA	Extreme ultraviolet monitor	EUVM	Long	Solar EUV flux in three band passes			LASP	9	N/A	N/A	N/A	Sun pointed to within 3°	1.4 kg	0.09 W (operational), 2.3 W (including heater).	16 x 13 x 9 cm	Sun pointing	10-20 nm, 17-22 nm, 121.6 nm	3 bands	48	1 sample per second	20	200	\$1.39M		Reflight of MAVEN EUVM requires external A/D signal processing electronics.	
SPA	Extreme ultraviolet monitor	EUVM v2	Long	Solar EUV flux in three band passes			LASP	4	1 month	\$10K	3 months	\$40K	Sun pointed to within 3°	0.75 kg	0.73 W (operational), 2.6 W (including heater).	10 x 10 x 7 cm	Sun pointing	10-20 nm, 17-22 nm, 121.6 nm	3 bands	48	1 sample per second	20	200	\$1.66M		Updated MAVEN EUVM design with internal A/D signal processing electronics.
SPA	Extreme ultraviolet monitor	EUVM v3	Long	Solar EUV flux in three band passes			LASP	4	3 months	\$60K	3 months	\$40K	Sun pointed to within 3°	1.1 kg	0.73 W (operational), 2.6 W (including heater).	15 x 10 x 7 cm	Sun pointing	10-20 nm, 17-22 nm, 121.6 nm	3 bands	48	1 sample per second	20	200	\$1.85M		Updated MAVEN EUVM design that mitigates soft x-ray contamination to signal resulting in a factor of two improvement in accuracy.

Table B-5. Performance metrics of instruments considered for the MOSAIC payload.

Investigation	Description	Name	Platform	Measurements (Up to 4; please link to physical parameters)		Supplier	TRL	Time to TRL5	\$ to TRL5	Time TRL 5 to 6	\$ TRL 5 to 6	FOV	Mass	Power	Volume	Accommodation/Operational Requirement	Wavelength/Frequency/Energy/Field Range	Resolution/Number of channels	Bits Per Sample	Sample Rate	Threshold Data Rate (bps)	Baseline Data Rate (orbit-average bps)	A-D Cost (\$FY20)	Contributable?	Notes
SPA	Ion electrostatic analyzer	Solar Wind Ion Analyzer	L1, high elliptical	Ion moments (density, temperature, velocity) of solar wind and magnetosheath H, with some discrimination of He using energy	Ion velocity distribution functions	SSL, SwRI	9	N/A	N/A	N/A	N/A	360 x 90° (3-axis stabilized)	1.8 kg	1 W	20 x 16 x 16 cm		N/A				500	1000	~\$3M		
SPA	Solid state telescope	solid state telescope	L1, high elliptical	Energetic ion flux in 4 look directions	Energetic electron flux in 4 look directions	SSL	9	N/A	N/A	N/A	N/A		1.1 kg	3.2 W							20	100	~\$0.8M		

B.1.7 Modularity / Flexibility of MOSAIC

The MOSAIC mission concept is inherently modular. Required measurements do not necessarily all need to be performed by the mission conceptualized in this report, nor does this mission have to be entirely funded and developed by NASA. Some measurements do not necessarily need to be taken simultaneously. This modularity provides significant flexibility in the implementation of the MOSAIC concept. The modularity takes three major forms as described in the following sections.

B.1.7.1 Existing / Planned assets

The first form of modularity is that existing and planned/funded Mars orbiters can partially or fully fulfill some of the investigations necessary to achieve MOSAIC’s objectives. Table B-6 demonstrates the degrees to which independently planned/executed missions can contribute to the MOSAIC investigations.

Table B-6. MOSAIC's investigations can be fulfilled to varying degrees (fully, mostly, significantly, or partially) by existing or planned Mars orbiters.

Mission Status	Missions & Instruments	Investigations	1 Ice Dis- tribution	2 Atmo- sphere structure	3 Atm. Diurnal Behavior	4 Thermo- sphere	5 Iono- sphere	6 Exo- sphere Neutral Escape	7 Plasma & Ion Escape	8 Space Weather
Operational	Mars Reconnaissance Orbiter MCS									
	MAVEN Particles & Fields Package									
	MAVEN IUVS									
	Trace Gas Orbiter NOMAD & ACS									
In Development	Emirates Mars Mission EXI & EMIRS (2021–)									
	Emirates Mars Mission EMUS (2021–)									
	China Tianwen-1 ion analyzer & magnetometer (2021–)									
	NASA ESCAPE (2025–)									
	JAXA-ESA MMX MacrOmega, MSA, & IREM (2025–2028 only)									
Concepts	Ice Mapper									
	COMPASS									

However, there are four key aspects of MOSAIC that are not being addressed at all by any existing or funded Mars mission:

- **Mapping of subsurface ice.** The COMPASS Discovery proposal (S. Byrne) and the recently-discussed Ice Mapper concept could both achieve most if not all of the goals of seasonal and interannual mapping of subsurface ice content.
 - Note 1: Neither of these concepts has been funded.
 - Note 2: Both use an L-band radar that may not be as appropriate as the MOSAIC P-band radar and sounder from the perspective of surface backscatter.
- **Wind measurements.** Such measurements form a crucial part of understanding the circulation within and between the lower atmosphere in the thermosphere. There is no current or planned substitute for the MOSAIC LIDAR, submillimeter, and interferometer instruments, which together provide comprehensive wind coverage from the surface to near the exobase.
- **Simultaneous diurnal coverage of atmospheric profiles of key constituents.** Current orbiters (MRO, TGO) provide altitude profiles of dust, water vapor, ice, and ozone at either fixed or very slowly varying local times, lacking diurnal coverage. The Emirates Mars Mission will provide diurnal

coverage of these quantities (every 10 days), but with no altitude information. In contrast, MOSAIC's low circular polar orbiters will provide these quantities at 8 local times every two hours.

- **Electric fields in the Mars magnetosphere.** To escape Mars, planetary ions must be energized/accelerated. Much of this acceleration is done by electric fields, which have never been measured directly at Mars. The 50-m wire booms on MOSAIC's spinning elliptical spacecraft will provide groundbreaking new insight into the physical processes by which ion loss occurs at Mars.

B.1.7.2 International or commercial contributions

The second way in which MOSAIC is flexible/modular is that there are six different types of platforms in the MOSAIC constellation. Each platform consists of one to three identical spacecraft with identical payloads. Following a long tradition of cost-sharing between international space agencies on high-value science missions, we suggest two different ways in which the cost of making these important measurements may be spread more widely among the various stakeholders.

The first is the traditional route of contributed instruments from international or commercial partners on NASA-funded buses. To ensure consistency of data and to leverage economies of scale, it is anticipated that all required copies of a given instrument would be contributed by the same partner. An example here could be magnetometers contributed from the Danish Technical University (DTU) or the Technical University of Braunschweig (TUBS).

The second route would be for the partner to be responsible for all copies of a given type of platform, including design, build, test, payload integration, and operation. For example, the partner organization could provide all three of the low-circular polar orbiting SmallSats, including their payloads. Compatibility testing would have to be conducted with other elements of the constellation if relay or radio occultation capability was required (as it would be in the SmallSat example, but not for the areostationary elements).

B.1.7.3 Graceful degradation with asynchronous or reduced capability

The third aspect of MOSAIC's modularity/flexibility concerns the degree to which its objectives can be met if some measurements are made asynchronously, incompletely, or not at all. Concerning asynchronicity, MOSAIC's mapping and seasonal monitoring of surface/subsurface ice would carry most of their scientific and exploration value even if they were conducted in a different Mars year than the rest of the measurements, as long as the same ranges of Martian solar longitude (Ls) were covered by both sets of measurements. This is because we do not expect the subsurface ice (unlike the atmosphere) to vary significantly on sub-seasonal timescales.

Concerning incomplete measurements, while simultaneous achievement of MOSAIC's four primary science objectives is required to comprehensively address its top-level science goal of understanding climate interconnections from the subsurface to the solar wind, there is still significant scientific value in partial fulfillment of the objectives, and particularly in completely fulfilling subsets of objectives.

Figures B-1 to B-5 outline the MOSAIC baseline constellation and several examples of descoped mission architectures, and their scientific costs. Green boxes represent completed investigations, orange boxes are partially completed, and red boxes are not meaningfully completed. Similarly, black objective text represents fulfilled objectives, orange text represents partially-fulfilled objectives, while crossed-out red text represents objectives not addressed at all.

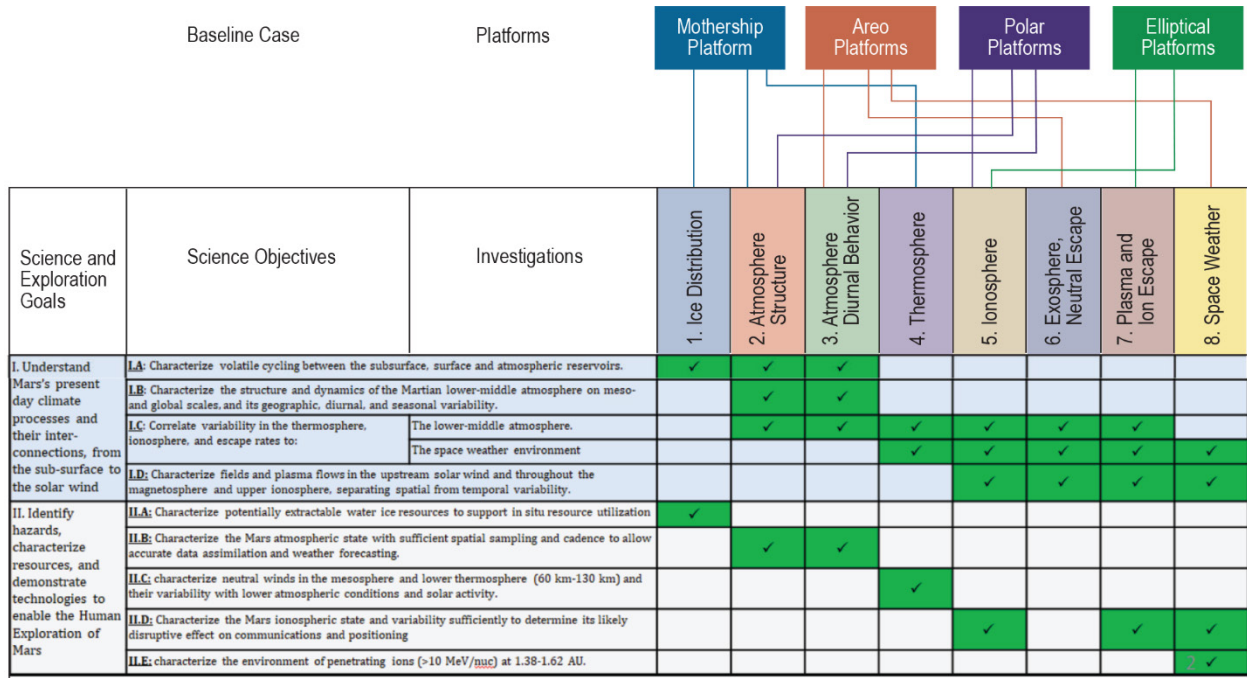

Figure B-1. MOSAIC Baseline Constellation. Green boxes represent completed investigations. Black objective text represents fulfilled objectives.

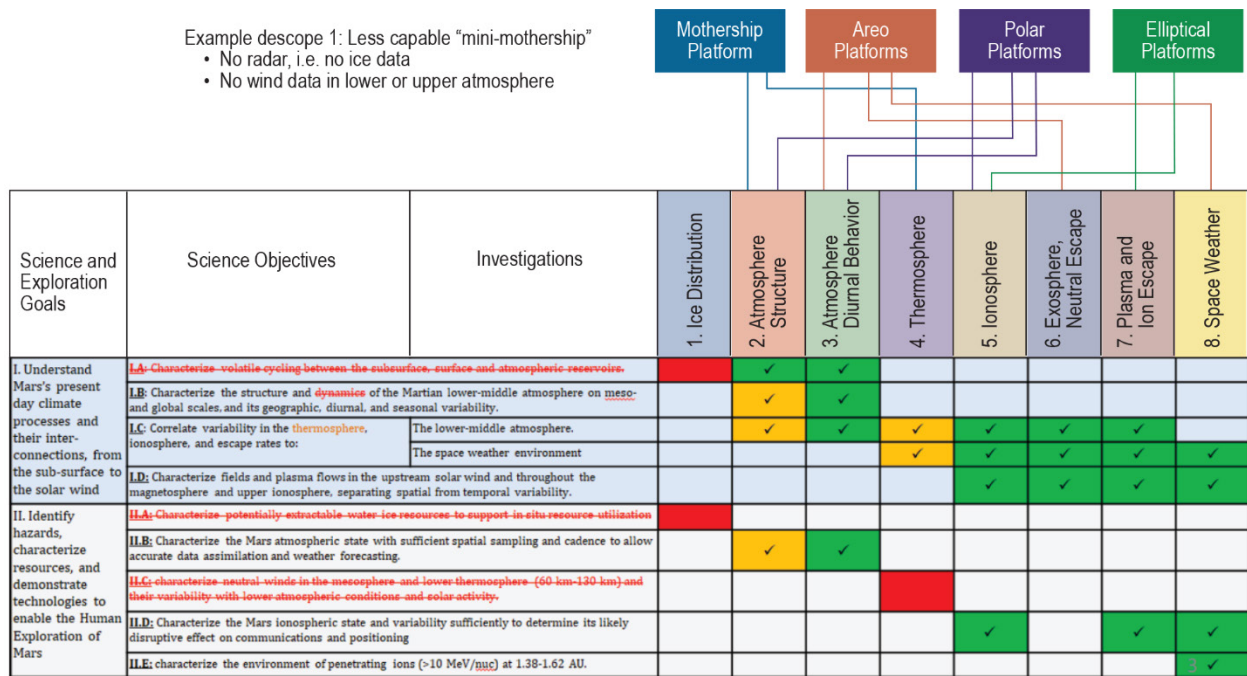

Figure B-2. MOSAIC Descscope 1 Constellation. Green boxes represent completed investigations, orange boxes are partially completed, and red boxes are not meaningfully completed. Similarly, black objective text represents fulfilled objectives, orange text represents partially-fulfilled objectives, while crossed-out red text represents objectives not addressed at all.

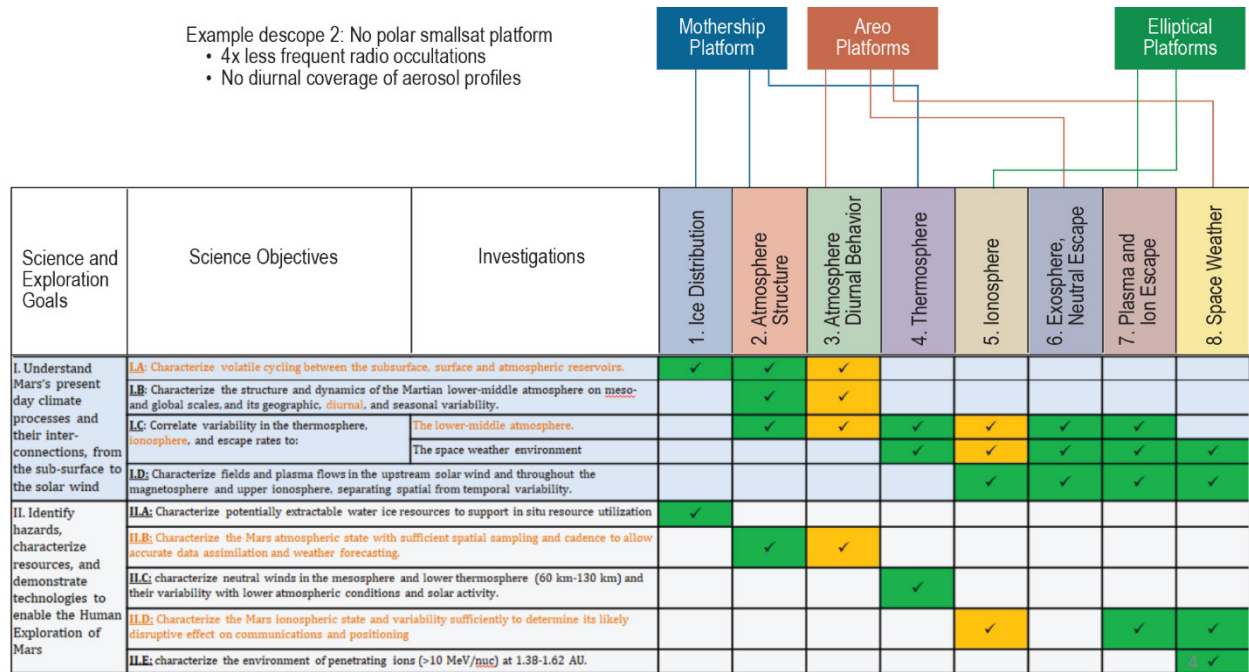

Figure B-3. MOSAIC Descscope 2 Constellation. Green boxes represent completed investigations, orange boxes are partially completed, and red boxes are not meaningfully completed. Similarly, black objective text represents fulfilled objectives, orange text represents partially-fulfilled objectives, while crossed-out red text represents objectives not addressed at all.

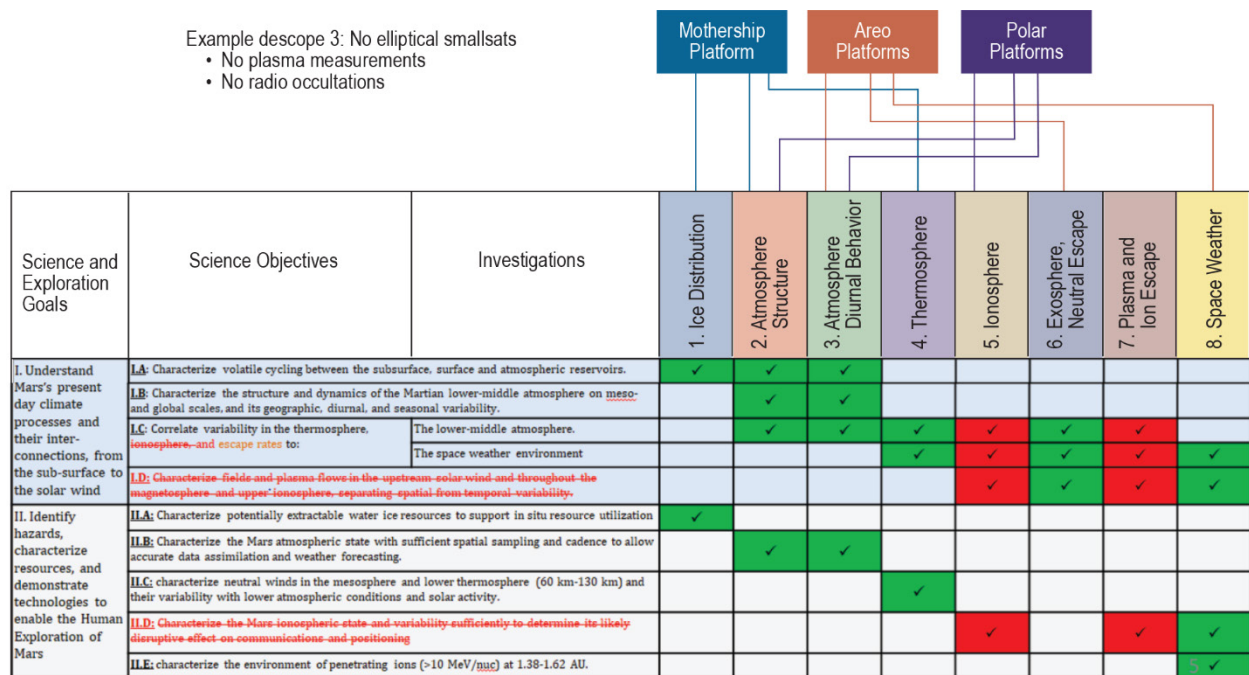

Figure B-4. MOSAIC Descscope 3 Constellation. Green boxes represent completed investigations and red boxes are not meaningfully completed. Similarly, black objective text represents fulfilled objectives, orange text represents partially-fulfilled objectives, while crossed-out red text represents objectives not addressed at all.

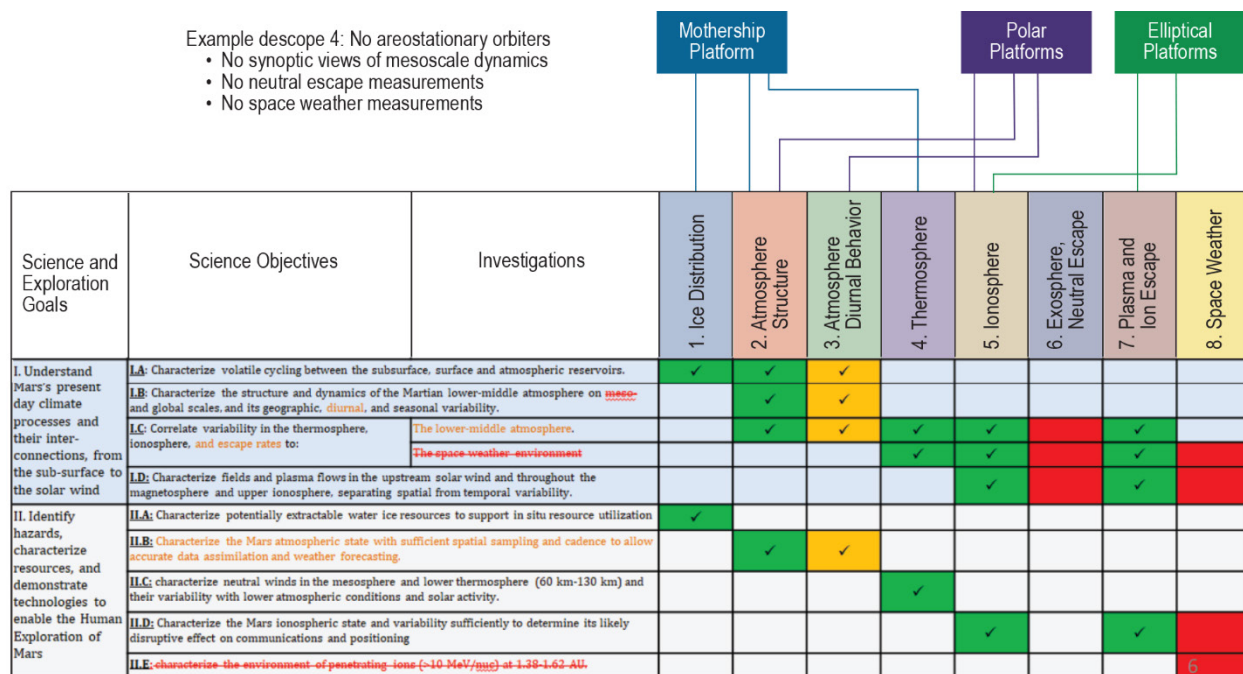

Figure B-5. MOSAIC Descscope 4 Constellation. Green boxes represent completed investigations, orange boxes are partially completed, and red boxes are not meaningfully completed. Similarly, black objective text represents fulfilled objectives, orange text represents partially-fulfilled objectives, while crossed-out red text represents objectives not addressed at all.

B.1.8 Comparison and synergy of MOSAIC with other missions

While some of the quantities that MOSAIC measures have been measured in the Martian system before (e.g., dust opacity, ion escape), MOSAIC is distinguished from prior investigations of various parts of the Mars climate system by three major factors:

- First-time measurements of crucial variables.** Shallow subsurface ice, winds in the lower, middle, and upper atmosphere, and electric fields in the magnetosphere all play key roles in the physical processes governing matter and energy flow within the Mars climate system. MOSAIC will characterize all these quantities systematically for the first time.
- Diurnal coverage and synoptic perspective.** Local times of previous measurements of important atmospheric quantities (e.g. temperature, dust, water vapor) have either been locked or drifted extremely slowly. MOSAIC will ensure full diurnal and geographic coverage of these quantities.
- Simultaneity.** To understand the interconnections within and between the various reservoirs of the Mars climate system, measurements of each major region must be made simultaneously, as MOSAIC will do for the first time.

Nonetheless, MOSAIC's science return will be even greater if its data are combined with existing or planned scientific missions. Here, we will compare atmospheric observations with five existing and planned missions with MOSAIC, as well as discuss MOSAIC's synergies with those missions.

ESA Trace Gas Orbiter

ESA's Trace Gas Orbiter (TGO) measures altitude profiles of H₂O, O₃, and aerosols but only at 6 a.m. and 6 p.m. (via solar occultation) (Vandaele et al. 2018), providing a precursor to MOSAIC's much more systematic sub-mm limb sounding. TGO also conducts traditional nadir mapping of temperature profiles, aerosols and water vapor (Korablev et al. 2018), as MRO MCS (McCleese et al. 2007) has done, but not continuously in time and simultaneously in space as MOSAIC will. Finally, TGO uses neutrons to derive total water ice abundance in the top ~1 m with 60–200 km resolution, which is complementary to the 1–10 m ice concentration data from MOSAIC.



Emirates Mars Mission (Hope)

The Emirates Mars Mission launched successfully in July 2020 and will start its science mission in May 2021. It will observe the Martian disk and exosphere from a 55 hour, 25° inclination high circular orbit (20,000 km × 43,000 km altitude). Assuming it is successful, its EMIRS and EXI instruments will make total column abundance and opacity measurements of dust, ice, water vapor, and ozone, with almost-full geographic coverage every 72 hours and almost-full diurnal coverage every 10 days (Amiri et al. 2017). These observations will serve as a science pathfinder, discovering new patterns and phenomena in the lower atmosphere and driving physical understanding. However, this spatial coverage will not enable the systematic characterization of the development of meteorological phenomena needed to understand the physical processes driving their origin and evolution or enable accurate weather forecasting, as MOSAIC's continuous full geographic and diurnal coverage will.

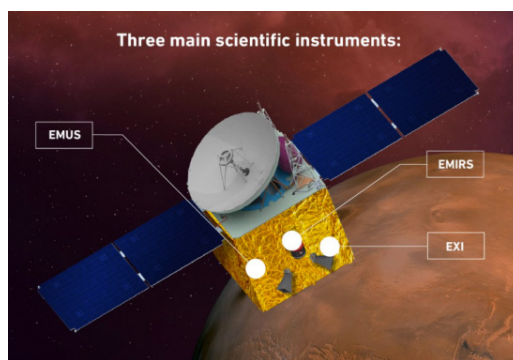

In addition, the EMUS instrument (Almatroushi et al. 2017) will make regular observations of the hydrogen and oxygen exospheres, sufficient to characterize escape rates and how they vary with lower atmospheric conditions. It is important to point out that, scientifically, EMUS is a completely satisfactory substitute for the EUV/FUV instrument envisioned for the MOSAIC large areostationary orbiter. However, EMM will likely be at least eight years old by the time MOSAIC arrives and most likely a replacement EUV/FUV spectrograph will be necessary to make measurements simultaneous with MOSAIC's comprehensive monitoring of the lower-middle atmosphere, thermosphere, ionosphere, and magnetosphere.

Mars Atmosphere and Volatile Evolution Mission (MAVEN)

The MAVEN mission has been collecting in situ and remote-sensing data on the Mars thermosphere, ionosphere, and magnetosphere from its elliptical orbit since November 2014. Over the last 5.5 years, analysis of the data it has returned has led to a much-improved understanding of the structure, composition, variability and dynamics of Mars' plasma environment (Romanelli et al. 2016, Ruhunusiri et al. 2017, Halekas et al. 2017, Harada, Halekas, et al. 2017, Xu et al. 2017, DiBraccio et al. 2017, Marquette et al. 2018, Halekas, Ruhunusiri, et al. 2016, Halekas, Brain, et al. 2016), including ion escape (Brain et al. 2015, Dong et al. 2015, Dong et al. 2017, Dubinin, Fraenz, Patzold, McFadden, Halekas, et al. 2017, Dubinin, Fraenz, Patzold, McFadden, Mahaffy, et al. 2017) and precipitation (Hara et al. 2017, Leblanc et al. 2015).

However, these single-point measurements are fundamentally limiting as they do not reveal real-time magnetospheric responses to solar wind disturbances or distinguish between spatial and temporal variations (see next section). Thus, the physical processes governing the transport of solar wind momentum and energy into and through Mars' hybrid magnetosphere, to ultimately drive escape, are currently not understood well enough to confidently estimate ion and sputtering escape rates over the large range of heliospheric and planetary conditions which have existed over Mars' history (Suzuki 2013).

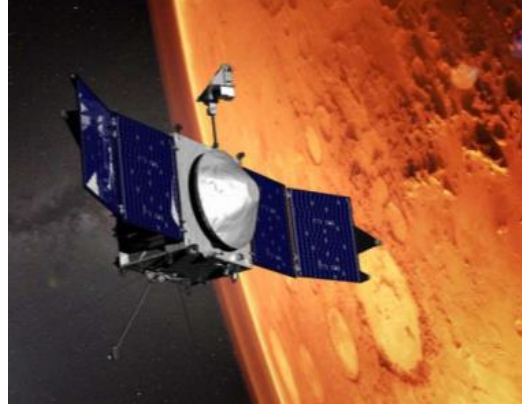

Multipoint measurements, as will be made by the MOSAIC Elliptical orbiters, have two main potential advantages over single-point measurements in enabling understanding of Mars' complex magnetosphere and its response to solar wind variability.

1. **Distinguish spatial from temporal variability.** Relative motion between a single spacecraft and plasma structures cannot be determined, greatly hampering our ability to understand dynamical phenomena, e.g. we cannot distinguish the motion of current sheets in the magnetotail versus plasmoids traveling down it, nor standing waves on the tail/sheath boundary versus 'blobs' of escaping ionospheric plasma (Halekas et al. 2016). In contrast, with two-point measurements, we can measure:
 - a. **Temporal variability.** Time-separated measurements across the same plasma boundary, or within the same volume, allow us to determine how the boundary moves/changes or how conditions within that volume change, over any timescale, not just once-per-orbit, e.g., at present we know statistically the distribution of magnetic pileup boundary (MPB) locations (Edberg et al. 2009), but we have no idea of how the MPB behaves on timescales of anything shorter than 4.5 hours, despite solar wind disturbances propagating through the system in 1-2 minutes (Harada et al. 2017).
 - b. **Spatial structure.** Spatially-separated simultaneous measurements made within a given plasma region (e.g., the magnetosheath or nightside ionosphere) unambiguously reveal how conditions in these regions vary spatially, over a range of spatial scales, and give clues as to 3D spatial structures and how such structures may vary orbit to orbit, e.g. at present we know statistically that Mars has a North-South upper ionospheric asymmetry (Dubinin 2012, Dubinin et al. 2008), but we do not know how instantaneous conditions in either hemisphere correlate with each other.
2. **Determine short-timescale response to solar wind (SW) variability.** Two-point measurements allow us to observe the response of the Martian magnetosphere to solar wind disturbances in real time. In contrast, for a single spacecraft in an elliptical Mars orbit that regularly samples both the exobase (~200 km, above which ion acceleration starts) and the upstream solar wind (e.g., MAVEN), **the typical time gap between any magnetosphere and solar wind measurement is over an hour.** This is problematic because:
 - a. **Solar wind conditions can change significantly over this time gap.** One important case is the passage of current sheets in the solar wind, which are ubiquitous and can occur in minutes and in rapid succession (Crooker et al. 2001). Observations suggest that enhancements in ion escape accompany such crossings (Edberg et al. 2010). The magnetosphere of Mars also reconfigures when the IMF orientation changes (Modolo et al. 2012). As both of these regularly occur with associated ion escape changes, it is important to know how this dynamic scenario for ion escape differs from the quasi-steady snapshot pictures developed from currently-existing measurement statistics and case studies.

- b. **Disturbed conditions present special challenges.** Conditions sometimes appear quasi-steady for low SW pressures ($< \sim 1.5$ nPa), but higher SW pressures typically occur at times of high variability. Under such circumstances, **SW pressure estimates from the most recent or next time the spacecraft is in the solar wind become essentially meaningless over timescales of > 45 minutes (Marquette et al. 2018).** Note that it is the response of ion and sputtered escape to precisely these high SW pressure cases that are especially important as they reflect early Mars' history when the solar wind was significantly more active (Suzuki 2013). Some solar wind disturbances (e.g., shocks) propagate through the Martian magnetosphere in 1-2 minutes (Ma et al. 2014, Harada et al. 2017), during which time a spacecraft, traveling < 5 km/s, is practically stationary. Similarly, upstream solar wind and foreshock wave-related variations are often short-lived (Ruhunusiri et al. 2016). The ion escape consequences of these disturbances can only be captured with spacecraft in both the solar wind and magnetosphere simultaneously.

Without multipoint measurements, models must be used to estimate the global escape rates associated with these key 'space weather' conditions, constrained only by observations over one limited orbit track, and with partial upstream information.

Rare multi-point studies demonstrate what is possible. A small number of prior studies have used plasma data from multiple spacecraft at Mars. MGS magnetometer data at 400 km (i.e., well inside the magnetosphere) were used as a rough, 2-hour-average proxy for solar wind pressure and IMF direction, to categorize ion escape measurements from MEx ASPERA-3 (Nilsson et al. 2010). Also, the passage of a magnetic field disturbance was observed when MAVEN was in the upstream solar wind and MEx was in the upper ionosphere with its MARSIS radar powered on ($\sim 5\%$ of the time (Gurnett et al. 2008)) and in a sufficiently dense, slow plasma to estimate magnetic field magnitude (Duru et al. 2008), serendipitously allowing the magnetic field jump to be observed at two locations (Harada et al. 2017). **These studies are rare but serve as a powerful demonstration of what MOSAIC's Elliptical orbiters will routinely accomplish over their prime mission with appropriate, identical instrumentation and coordinated orbits.**

However, going forward MAVEN will continue to make in situ plasma observations of the Mars environment and therefore will be highly complementary to the MOSAIC Elliptical orbiters, providing a third point of measurement within the dynamic Mars plasma environment. However, it will not be sufficient to replace either of them since MAVEN's periapsis going forward has been raised to slightly above the exobase at around 200 km altitude, i.e. it will not be sampling the Martian thermosphere anymore. In addition, its apoapsis has been reduced to 4300 km, meaning it crosses the bow shock on less than 40% of orbits. MAVEN has sufficient fuel to continue until at least 2030 (Jakosky 2018), so there is a reasonable chance MAVEN's complementary data can increase the science return of MOSAIC.

ESCAPADE

Many of the same arguments for coordinated multi-point plasma measurements in the Mars environment made in the previous section were made to justify the selection of the EscaPADE under the NASA Small Innovative Missions for Planetary Exploration (SIMPLEX-2) program in July 2019 (after the submission of the MOSAIC PMCS proposal). EscaPADE is a \$55 million cost-capped Class D tailored mission consisting of two identical spacecraft (Lillis et al. 2019) making many of the same measurements as the proposed MOSAIC elliptical orbiters. The spacecraft would launch in 2022 and arrive at Mars in late 2025.

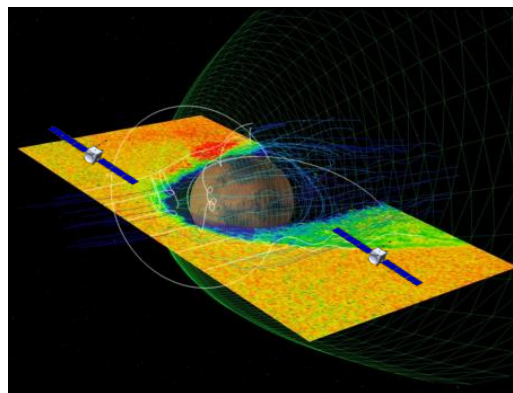

To ask an obvious question, why are the MOSAIC Elliptical orbiters needed if EscaPADE will be in orbit around Mars already? To this there are at least four responses:

1. **No electric fields.** Neither MAVEN nor EscaPADE have the ability to directly measure electric fields, i.e. the prime driver for accelerating plasma throughout the magnetosphere and driving both sputtering and ion escape. MOSAIC would measure electric field in the Mars environment for the first time, thereby revolutionizing our understanding of the forces that drive energy and matter flow throughout Mars' unique hybrid magnetosphere.
2. **Risk of failure.** EscaPADE's confirmation review is scheduled for late September 2020, and thus it is not yet a confirmed mission. SIMPLEx is a new paradigm for doing science missions at a fraction of typical prior costs. Many lessons are being learned by both the EscaPADE team and NASA Headquarters (HQ) on the fly and there is no guarantee that EscaPADE will be confirmed or even make its launch date and survive the cruise to Mars if it is confirmed.
3. **Reliability/longevity.** As part of its low-cost paradigm, EscaPADE uses many COTS parts and systems. There is no guarantee whatsoever that both of the EscaPADE spacecraft will still be operational by the time MOSAIC arrives at Mars, so that it could observe the dynamic magnetosphere and ionosphere simultaneously with the other assets observing the lower-middle atmosphere and thermosphere, which are the source reservoir for the magnetosphere.
4. **Plasma FOV.** EscaPADE's measurements of suprathermal electrons and ions are highly constrained by being body-mounted on a three-axis stabilized platform (budget and schedule constraints precluded a boom), so its electron and ion electrostatic analyzers are limited to fields of view of $240^\circ \times \pm 45^\circ$, (~65% of the full sky) and are therefore likely to miss important plasma flows in their blind spots. MOSAIC's spinning elliptical platform will ensure complete 4π coverage of Mars' plasma environment.

Martian Moons Explorer (MMX)

The Japan Aerospace Exploration Agency (JAXA) Martian Moons Explorer (MMX) will be in Mars orbit near the position of Phobos for three years from 2025 until 2028 (Kuramoto, Kawakatsu, and Fujimoto). Though it was designed to study Mars' larger moon Phobos, during that time it will also make measurements of the Martian atmosphere and plasma environment. The Mass Spectrum Analyzer will measure the mass, energy, and direction of suprathermal ions, complementing the MOSAIC Elliptical orbiters' measurements of ion escape from Mars. Further, its MacrOmega near-infrared imaging spectrometer will study emissions from the Mars lower atmosphere. However, it is important to point out that MMX will not get closer than 6000 km from Mars and hence, while complementary, its measurements will not substitute for MOSAIC measurements in any way.



B.2 A Team Science and Architecture Early Trade Space Exploration Design Study Report Summary

The JPL A Team design study goal was to produce a small number of MOSAIC trade space points to carry forward into CML work (Team Xc, Team X, Team X Follow On).

The study objectives were: 1) cover the MOSAIC science trade space: science questions, science objectives, observables, measurements, instruments, payload combinations, TRL, and cost to get to TRL, 2) understand the possible architectures and CML 3 cost bins, 3) understand and pick trade space points (science/architecture) to carry forward to Team Xc, and 4) decide what technologies would enable parts of the trade space over the Decadal span.

The study products encompass: 1) a list of trade space points to carry forward, including the Team Xc input package (spacecraft + payload), 2) a list enabling technologies and capability needs, 3) a list of questions to be addressed, assignments, and due dates.

The study investigated 13 architectures that are detailed in Table B-7. The architectures were assessed by science objective (Figure B-6) and non-science figures of merit (Figure B-7). A weighted architecture score was given as shown in Figure B-8. The cost of several Mothership variants by FY25 were assessed as provided in Figure B-9.

Table B-7. MOSAIC architectures as discussed in A Team design study, which was a preliminary architecture design assessment. These architectures are not directly correlated to the point designs from Team Xc, Team X, and Team X Follow On. MS = Mothership, Inv = Investigation, Areo = Areostationary, RO = Radio Occultation.

Architecture Number	Name	Details
1	Baseline	One MS, 4 Areo (two for Inv. 3/6, two for Inv. 3/8), 3 Polar, 2 Elliptical (spinning, with electric fields), no long orbits Areo for Inv. 3/6: visible camera, mini thermal IR radiometer, mini near-IR spectrometer, FUV/EUV spectrograph
		Areo for Inv. 3/8: visible camera, mini thermal IR radiometer, mini near-IR spectrometer, fluxgate magnetometer, ion energy/angle, electron energy/angle, energetic ion/electron, extreme UV monitor
		Polar: three spacecrafts, four local time planes (three fixed local crossings plus the MS), omni communication antenna, medium gain antenna pointed at Elliptical in velocity and anti-velocity directions (there is already nadir (NIR spectrometer) constraint and mini MCS looking at forward limb)
		Elliptical: spinning spacecraft, only talks to MS, 8 booms (2-3.5m stacer in rotation axis, 4-25 m wire booms in equatorial, one 1-m folding rigid boom for flux gate magnetometer, one 1-m rigid boom for SCM), like THEMIS
2	Baseline with MS-dropped RO-dedicated sats	Same as Baseline but with 3 small RO-dedicated sats dropped off by MS, eliminates any possible RO problems with spinning spacecraft
3	Baseline minus electric field/spinning	Removes electric field instrument from Elliptical
4	Threshold	Descoped MS, one Areo (for Inv. 3/6/8)
		MS: P-SAR, visible camera (MAVRIC), thermal IR radiometer, Wind LIDAR, "half-sized" sub-mm sounder, wind Doppler interferometer, and FUV/MUV spectrometer
		Areo: One larger spacecraft for Inv. 3/6/8 (visible camera, mini thermal IR radiometer, mini near IR spectrometer, FUV/EUV spectrograph, fluxgate magnetometer, ion energy/angle, electron energy/angle, energetic ion/electron, extreme UV monitor), SEP would be necessary
		Polar: One spacecraft rather than the three used in Baseline Elliptical: Two spacecrafts, but no spinning, no electric fields, no SCM (2 booms for magnetometer and ESA, like ESCAPADE)
5	Investigations 2/3 architecture	Polar and Areo, no Elliptical RO
6	MS with P-SAR and visible camera	
7	Baseline MS (no constellation)	Gets no diurnal information
8	MS with P-SAR + wind LIDAR + AMCS (thermal IR radiometer) + MAVRIC (visible camera)	MS thermal IR radiometer, P-band radar, LIDAR, visible camera, only MS and no constellation
9	Baseline MS with no P-SAR and no constellation	
10	MS, Polar, 1 Areo with Inv. 3 instruments (visible camera, mini thermal IR radiometer, mini near IR spectrometer), and Elliptical for RO	
11	3 x Areo satellites, one each targeting Inv. 3, 3/6, and 3/8	Areo 1 = visible camera, mini thermal IR radiometer, mini near-IR spectrometer
		Areo 2 = visible camera, mini thermal IR radiometer, mini near-IR spectrometer, FUV/EUV spectrograph
		Areo 3 = visible camera, mini thermal IR radiometer, mini near-IR spectrometer, fluxgate magnetometer, ion energy/angle, electron energy/angle, energetic ion/electron, extreme UV monitor
12	Baseline MS with no P-SAR or wind LIDAR (no constellation)	
13	Baseline minus P-SAR, LIDAR, sub-mm, wind interferometer	Exactly the Baseline without four instruments from MS

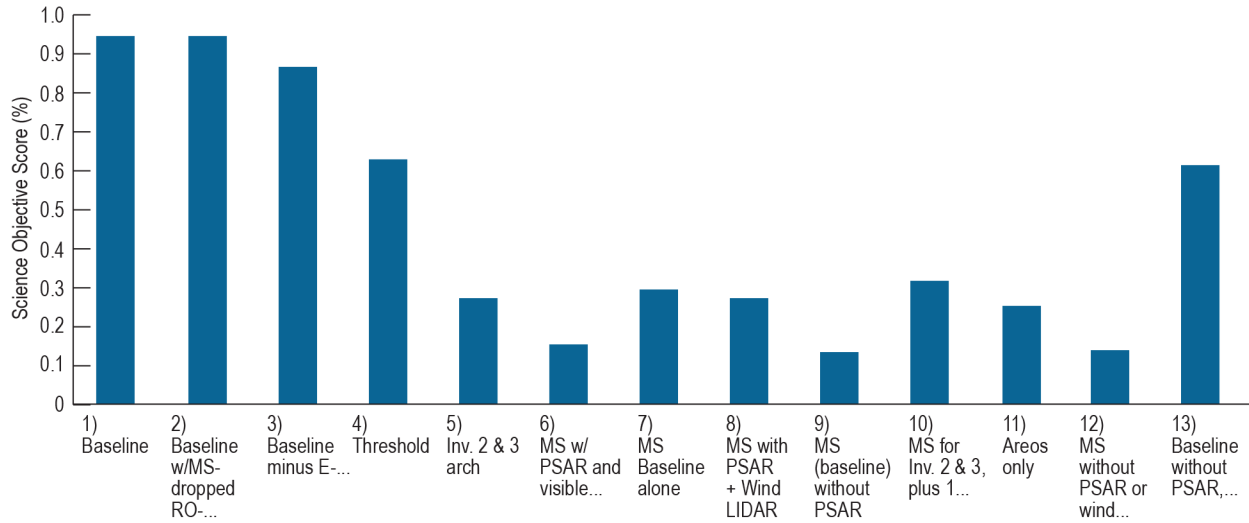

Figure B-6. Architectures as listed in Table B-7 evaluated by science objectives.

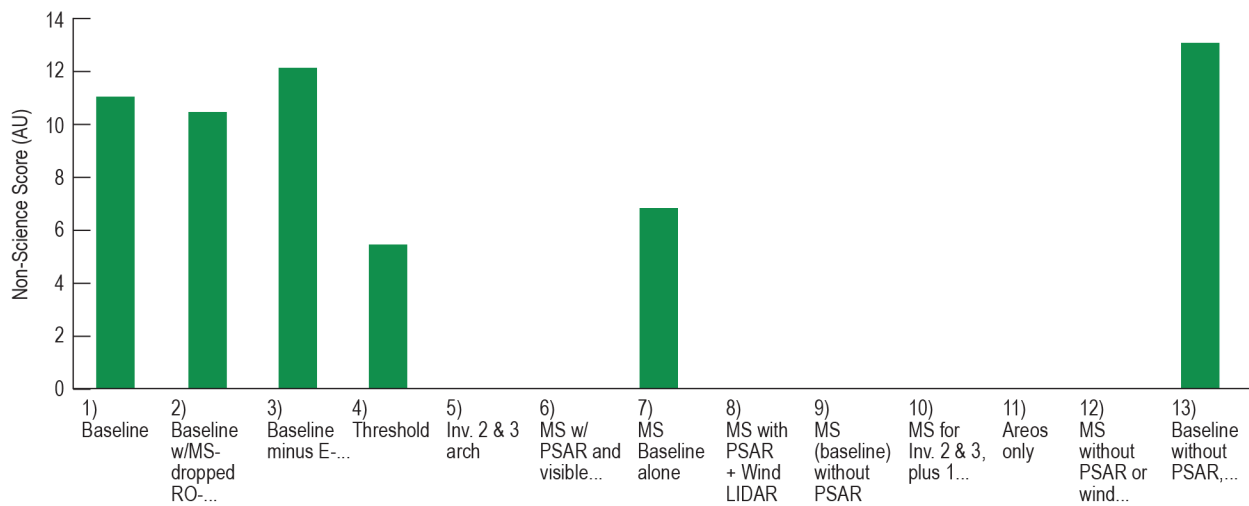

Figure B-7. Architectures as listed in Table B-7 evaluated by non-science figures of merit.

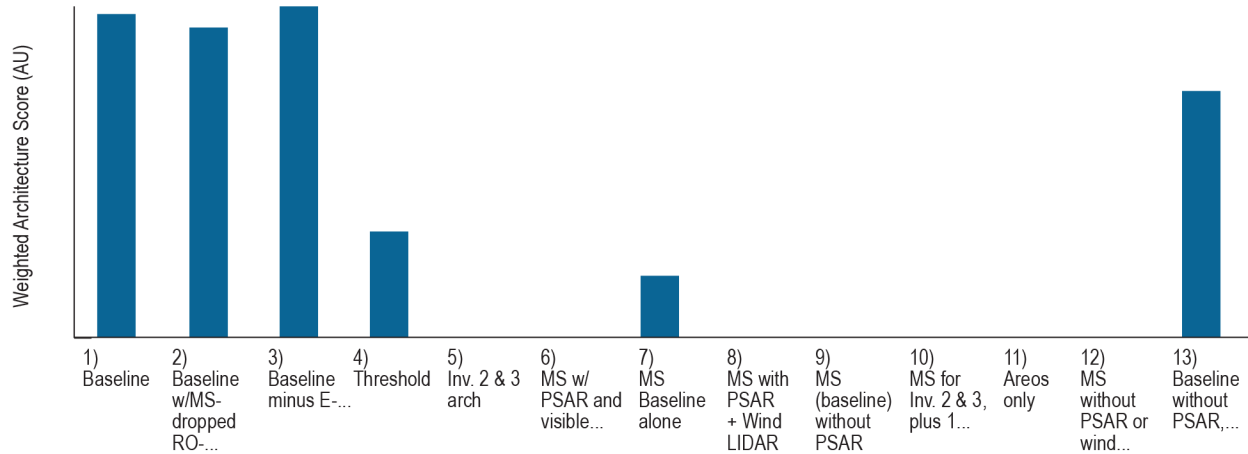

Figure B-8. Weighted architecture score for architectures listed in Table B-7.

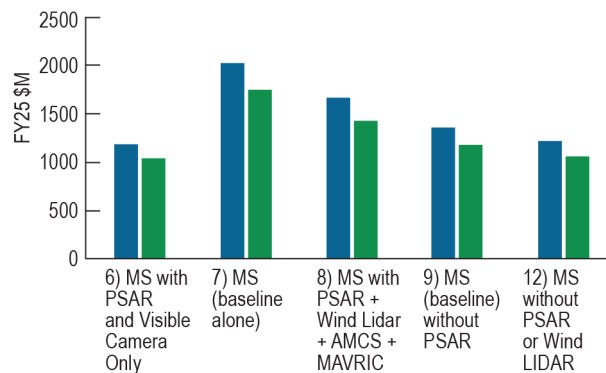

Figure B-9. Five Mothership variants with FY25 cost. Blue color is cost with 50% reserves, green color is cost with 30% reserves.

A list of questions and homework was assigned to the MOSAIC study team as one of the study outcomes. The list of the questions was:

- Is the sub-mm sounder baseline or threshold?
- What cost models will be used in the study? What cost models will the decadal survey use?
- What related cost models can be brought into the study?
- Ask HQ if the study can include a link/animation?
- Develop more detail on the threshold mission. Why is the threshold mission so much smaller?
- Clearly define worst-case scenarios
- Configuration solution for Mothership and Areo.
- What should the inclination distribution of Areos be?
- Are there studies of larger Areo spacecraft that could be references?
- What is the concept of operations for the Areo camera?
- Trade investigation 6 and 8 on Areos
- How much will independent flight to Mars architecture be studied?
- Should Mothership/Polars spend some time at 90 degree inclination or walk in local time?
- Research P-SAR data processing

- Does radio occultation work with only Mothership, 1 Polar, 1 Elliptical?
- Does link close over whole Elliptical orbit?
- Does this change if spinning or not spinning?
- If not, is coverage sufficient?
- S omni-omni from Elliptical to Polar?
- Investigate radio occultation between Mothership and dedicated cubesats?
- Is there a useful Investigation 5 with no Elliptical spacecraft?
- Does X-band omni-omni close/exist? How much power?
- Determine where each contribution could come from
- How to star trackers on spinners work? THEMIS, MMS, and other spinners?

B.3 Team Xc Design Study Report Summary

The goal of this JPL Team Xc design study was to design 3 spacecraft elements as part of the Mars MOSAIC pre-decadal study, as shown in Figure B-10. All three are part of the MOSAIC constellation at Mars. Each is in a different orbit, with different instruments and different design constraints:

- **Polar Orbit SmallSat** (3-4 identical spacecrafts)
- **Spinning Elliptical Orbit SmallSat** (2 identical spacecrafts)
- **Areostationary SEP Spacecraft** (later called Areo Carrier) (1 spacecraft)

The 3 Areostationary SmallSat/CubeSats carried by the Areo Carrier were not investigated in this design study.

The Mothership was investigated in the JPL Team X study covered in Appendix B.4.

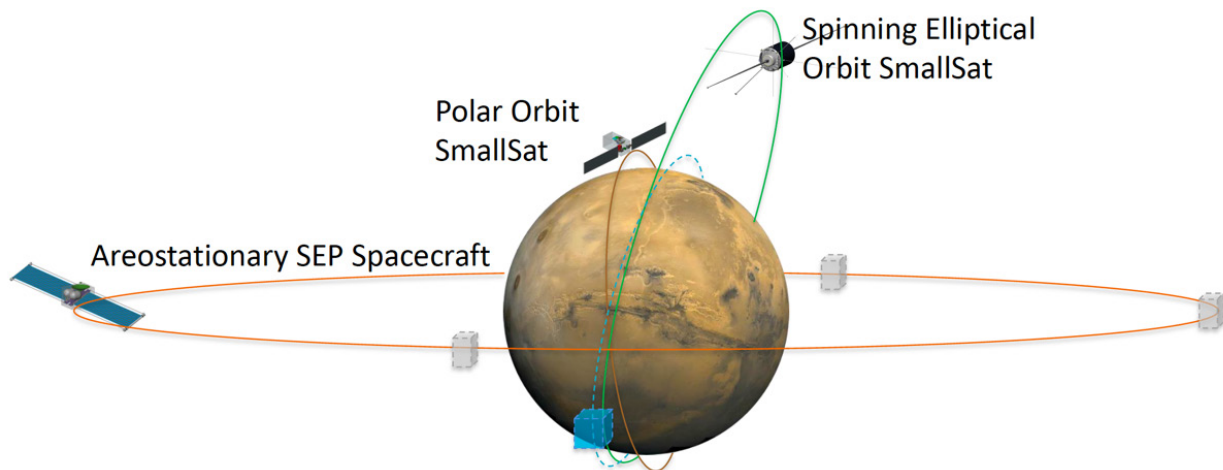

Figure B-10. Overview of spacecrafts covered in the Team Xc design study.

B.3.1 Systems

B.3.1.1 Polar Orbiter SmallSat

Each spacecraft has three instruments which need pointing, see Figure B-11.

- Limb Infrared Radiometer: Limb-pointed
- NIR Spectrometer: Nadir-pointed
- Radio Occultation with X-band and UHF: pointed to other spacecraft

The spacecraft configuration allows all three to be satisfied, though not necessarily simultaneously 100% of the time. The main considerations are:

- The solar arrays are on two-axis gimbals
 - This allows them to stay sun-pointed for all three required local times (12, 6, 9) with a single design (9 a.m./9 p.m. is the most stressing case)
- The NIR Spectrometer is on a nadir deck
 - The nadir deck can stay nadir-pointed at all times
- The Limb Infrared Radiometer is on another face
 - It cannot point at the sun
 - No specific limb direction constraints were assumed
 - For the 12 a.m./12 p.m. spacecraft (S/C), it might be better mounted on a different face, but this implies different designs for the different spacecraft. Or, that S/C could do a 180° flip twice per orbit.
- The antennas are opposite the Radiometer
 - Capturing some radio occultation opportunities might mean slewing and operating off-sun for 15 minutes; battery is already sized for eclipse case, which is more stressing (0.7 hours)
 - Some radio occultation opportunities might need to be missed, if they require the Limb Infrared Radiometer to point at the sun

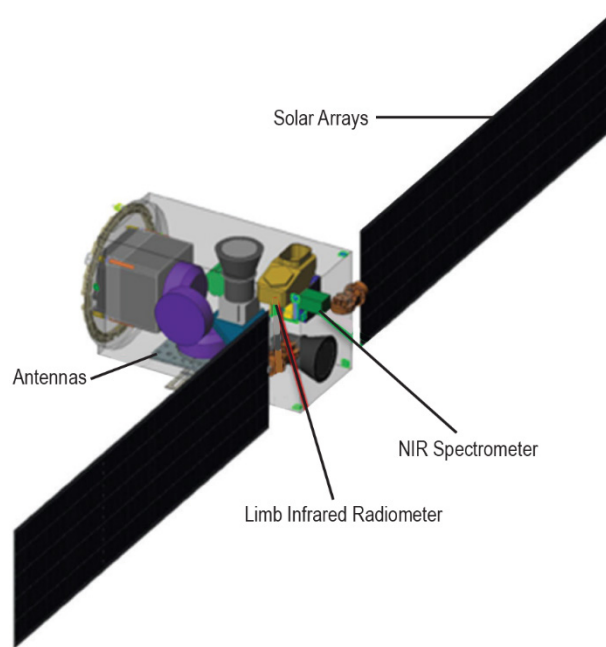

Figure B-11. Configuration and Instrument Accommodations on Polar SmallSat.

Spacecraft Design

- ACS
 - 3-axis stabilized
 - Star Trackers, Sun Sensors, IMU
 - Reaction wheels

- CDS
 - Sphinx Avionics Board
 - Interface card
- Mechanical
 - Primary structure (16 kg CBE)
 - 2-axis Solar Array gimbals
 - Cabling (5.8 kg)
- Power
 - Rigid-panel deployable solar arrays, 2 wings
 - Li-Ion batteries
 - CubeSat EPS
- Propulsion
 - COTS Monoprop propulsion system (MPS-135-8U)
- Telecom
 - IRIS v2 Radio
 - UHF Loop antenna
 - 4× X-band Patch Arrays (each is 4×4 patch)
 - UHF Diplexer
- Thermal
 - MLI
 - Radiator
 - Heaters, Thermostats, PRTs

System Summary

- Total wet mass of 92 kg
- This fits very comfortably within an ESPA allocation of 180 kg
 - JPL Margin of 66%, NASA Margin of 144%
- Total propellant load was 9.6 kg, with 225 m/s of Delta-V supplied by a COTS Monoprop system, using Green propellant, with an Isp of 266 s
- Total power demand was a maximum of 148 W while maneuvering, with steady-state ~100 W demand during the Science phase of the mission

Risk

- If the pointing constraints for the limb instrument are actually tighter (say, if it requires a particular limb direction), then each of the three spacecrafts may need a slightly different configuration to handle the different times of day
 - This would be a cost upper (some NRE moves to RE)
 - It would also impose more constraints on the radio occultations, reducing opportunities

B.3.1.2 Spinning Elliptical Orbit SmallSat

Configuration and Orientation Design Drivers:

- Need to spin one of the instruments (spinner design)
 - A 3-axis S/C with a spin platform for the single spinning instrument would be a feasible alternative, but was avoided to reduce cost and complexity
- Need UHF relay telecom to the Mothership
 - Constraint on orientation and telecom gain pattern

- Need UHF/X-band radio occultation interactions with the Polar Orbiting SmallSats
 - Constraint on orientation and telecom gain pattern (similar to UHF relay constraint)
- Need solar power

Several configuration options were considered such as partial spun and de-spun sections (was ruled out due to reduced spacecraft cost and complexity), a “Juno-style” spinner (was ruled out as there are no ‘free’ axes that can be oriented to maximize occultation opportunities), and an omnidirectional radio science antennas on spinner (was ruled out due to reduced gain requiring the amplifier power to increase, which drives an increase in solar array area which breaks the small spacecraft volumetric constraints). Finally, a cylindrical bus, with wraparound body-mounted solar arrays and axial radio science antennas on each end was selected, as shown in Figure B-12. The rationale for this selection is as follows:

- The antennas on only one end of the spacecraft will be used at any given time
- The elliptical orbit will “walk” around Mars (argument of periapsis and longitude of ascending node will change)
 - During some parts of the mission, the spacecraft should see many radio science opportunities; while at others, it will see fewer
- The likely worst case orientation of the orbit with respect to Mars-Sun line and Polar SmallSat orbit is shown in Figure B-12
 - Orientation of antennas along spin axis (and 50 deg cone) means that S/C will only have occultation opportunities in a few places in the orbit
- The science team has to determine whether, over the course of the entire science phase, there are enough radio science opportunities, and sufficient temporal coverage
 - The S/C-sun line defines one “free” axis that can be adjusted to maximize the radio science opportunities

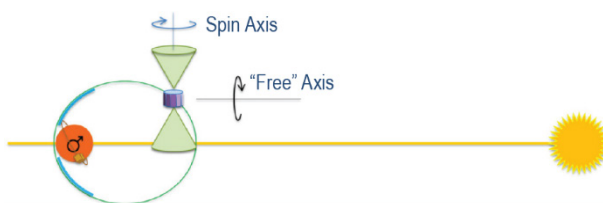

Figure B-12. Selected cylindrical configuration with wraparound solar arrays and axial radio science antennas on each end.

The configuration and pointing of each of the six instruments plus the radio occultation is shown in Table B-8.

Table B-8. Instrument Accommodation on Spinning Elliptical SmallSat.

	Fluxgate Magnetometer	Search Coil Magnetometer	Ion Energy/Angle/Mass Spectrometer (THEMIS ESA)	Electron Energy/Angle Spectrometer (THEMIS ESA)	Electric Fields (THEMIS EFI)	Langmuir Probe Mini	Radio Occultation
Pointing Requirement	Spun	None	None	None	Spun at ~15 rpm	None	Fixed pointing through occultations
Configuration Constraints/ Specification	2 m boom	3 orthogonal 18 cm-long rods on a 1-m boom	Clear FOV (360 × 90°)	Clear FOV (360 × 120°)	4 radial wire booms (20 m) and 2 axial stacer booms (5 m)	0.5 m boom	
Configuration	2 m boom, axial	3 orthogonal 18 cm-long rods on a 1-m boom, radial	Body-mounted	Body-mounted	4 radial wire booms (20 m) and 2 axial stacer booms (5 m)	0.5 m boom, radial	Axial, UHF and X-band antenna on each end

The spacecraft design is defined as follows and can be seen in Figure B-13.

- ACS
 - Spinner
 - Miniature spinning sun sensor
 - Horizon sensor
 - IMU
- CDS
 - Sphinx Avionics Board
 - Interface card
- Mechanical
 - Primary structure (50 kg CBE)
 - Cabling (9 kg)
- Power
 - Wrap-around body-fixed solar arrays
 - Li-Ion batteries
 - CubeSat EPS
- Propulsion
 - Monoprop system
 - 4 axial Monoprop thrusters for Delta-V
 - 2 small radial Monoprop thrusters for spin-up
 - 0.119 m³ tank
- Telecom
 - IRIS v2 Radio
 - 2x UHF Loop antenna (1 on each axial end of the S/C)
 - 4x X-band Patch Arrays (2 on each axial end of the S/C)
 - Each patch array is 4x4 patches
 - Switch and UHF Diplexer
- Thermal
 - MLI
 - Radiator
 - Heaters, Thermostats, PRTs

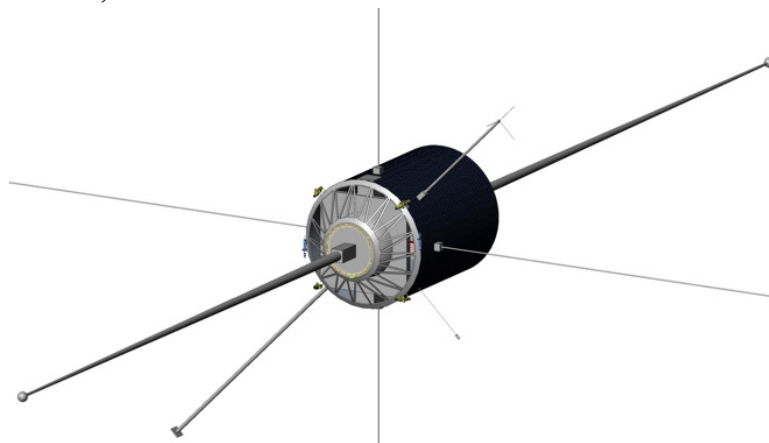

Figure B-13. Spacecraft Design of Spinning Elliptical SmallSat.

System Summary

- Total wet mass of 235 kg
- This is outside the ESPA allocation of 180 kg, but fits comfortably within an ESPA Grande allocation of 318 kg
 - JPL Margin of 53%, NASA Margin of 75%
- Total propellant load was 64 kg, with 500 m/s of Delta-V supplied by a Monoprop system with a main-engine Isp of 229 s
- Total power demand was a maximum of 85 W while maneuvering, with steady-state 71 W demand during the Science phase of the mission

Risk

- There is a risk that the Radio Occultation opportunities will not be frequent enough to answer the science questions
 - If this were the case, the spinning architecture would need to be re-thought
- The FOVs of the Ion energy/angle/mass Spectrometer and the Electron Energy/Angle Spectrometer are requested to be “clear”, but with so many long booms, this is not technically possible; hopefully, they can deal with just being “mostly clear”

B.3.1.3 Areostationary SEP Spacecraft

Configuration constraints during the Science Phase, as shown in Figure B-14:

- Solar arrays at Sun
- Sun-pointed instruments: one to within three degrees of sun center
- Mars-pointed instruments: Camera to within a few degrees of Mars center; rest need to scan (all have scan mirrors so they can scan on their own)
- High Gain Antenna: needs to point at Earth most of the time (2×8 hr passes per day)

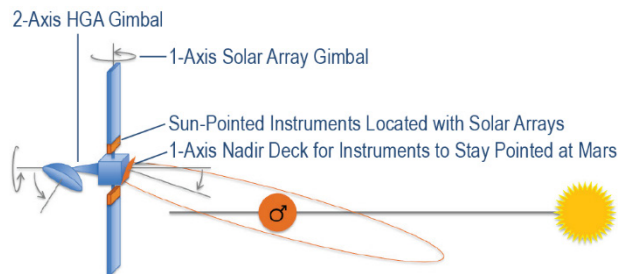

Figure B-14. Configuration constraints during science phase for Areostationary SEP spacecraft.

Instrument accommodation, also see Figure B-15:

- 2 instruments body-mounted
 - Fluxgate Magnetometer
 - Ion Energy/Angle
- 3 instruments co-located with solar arrays
 - Electron Energy/Angle Spectrometer
 - Energetic Ion/Electron
 - Extreme Ultraviolet
 - Requires pointing to within 3 deg

- 3 instruments on a 1-axis nadir deck
 - Visible camera
 - Needs full Mars disk to stay within FOV; at Areostationary, this mean keeping within 1 deg of Mars center
 - NIR Spectrometer
 - Used Argus 2000 data sheet
 - Assumed a scan mirror
 - Assumed 1 kg and 3.5 W
 - Nadir Infrared Radiometer (added scan mirror, assumed +0.5 W and +0.5 kg)
 - FUV Spectrograph (assumed scan mirror is included in mass)

Instruments on Solar arrays are assumed to not use slip rings for cabling. therefore we assume the spacecraft requires a 180° "cartwheel" twice per orbit to keep the cables from tangling.

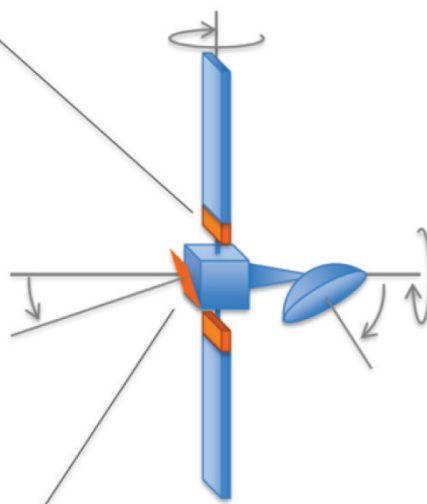

A 1-axis gimbaled nadir deck keeps all nadir-facing instruments pointing exactly at the center of Mars. Any additional scanning needed by the instruments is assumed to be performed with individual scan mirrors.

Figure B-15. Instrument accommodation on Areostationary SEP spacecraft.

Spacecraft Design

- ACS
 - Uses EP and reaction wheels for control; no chemical or cold gas RCS system
 - Reaction wheels (Honeywell HR14)
 - IMU (MIMU)
 - Star Tracker (Sodern Hydra)
 - Sun Sensors
- CDS
 - Sphinx Avionics Board
 - Interface cards
- Mechanical
 - Primary structure (100 kg CBE)
 - Cabling (39 kg)

- 1-axis SA gimbal
- 2-axis HGA gimbals
- Nadir deck with 1-axis gimbal
- Power
 - ROSA arrays, 3.4 kW @ Earth, 10m² total, 2 wings, on 1-axis gimbal
 - Li-Ion batteries
 - Standard JPL power electronics to handle large loads
- Propulsion
 - 4× MaSMi EP thrusters (3 in use, 1 on-board spare)
 - 2× .078 m³ Xe tanks
- Telecom
 - Dual-band X and Ka
 - 1 m HGA on deployable boom and 2-axis gimbals
 - 250 WRF Ka-band TWTA
 - 25 WRF X-band TWTA
- Thermal
 - MLI, heaters
 - Radiators: 1.8 m² (may have some difficulty placing on free bus faces)

Systems Summary

- Including the 214.5 kg of carried element mass, the total spacecraft wet mass is 1011.7 kg
- Propulsion is sized to a 1011.7 kg allocation
- Full JPL contingency (43%) applied to Mothership payload and spacecraft
- Total propellant load is 287 kg of Xe; assumed an average Isp of 1800 s and 5 km/s of total Delta-V
- Total power demand is a maximum of 3290 W at Earth, and 1303 W at Mars (both driven by EP)

Risk

- At about 1000 kg, this is no longer a SmallSat
 - It does not fit in ESPA mass or volume constraints, though using multiple ports may be feasible
 - This spacecraft could be re-designed to fit within an ESPA ring, and use the ring as primary structure
- The entire Areostationary component of the mission depends on this spacecraft
 - A SmallSat risk posture is likely inappropriate. Rather than Class D parts and single-string, this spacecraft should be at least Class B, and dual-string
 - This will result in further mass and cost growth

B.3.2 Mission Design

B.3.2.1 Polar Orbit SmallSat

The cost for the Polar Orbit SmallSat is summarized in Table B-9. The cost was estimated for a single Polar orbiter. The cost was hard to model using current Team X tools and the cost delta/increase for “formations” is \$2M (FY25), good “per unit” estimate. The cost estimate includes the cost for plane change and science operations.

Table B-9. Polar Orbit SmallSat cost summary table in FY25.

	12	12.01	12.02	12.03	12.04	07 and 09	9A.06	7.06	7.08	Total
Phase A Total Cost (\$M)	0.49	0.04	0.26	0.00	0.18	0.00	0.00	0.00	0.00	0.49
Phase B Total Cost (\$M)	1.84	0.22	0.44	0.41	0.77	0.03	0.03	0.00	0.00	1.87
Phase C Total Cost (\$M)	5.52	0.26	0.42	3.72	1.12	0.25	0.25	0.00	0.00	5.77
Phase D1 Total Cost (\$M)	2.83	0.34	0.17	1.72	0.60	0.84	0.25	0.60	0.00	3.68
Phase D2 Total Cost (\$M)	0.50	0.02	0.12	0.36	0.00	0.09	0.00	0.09	0.00	0.59
Phase E Total Cost (\$M)	0.00	0.00	0.00	0.00	0.00	2.97	0.09	2.62	0.26	2.97
Development Total (Phases A–D)	11.18	0.88	1.41	6.22	2.67	1.21	0.52	0.69	0.00	12.39
Ops Total	0.00	0.00	0.00	0.00	0.00	2.97	0.09	2.62	0.26	2.97
Total	11.18	0.88	1.41	6.22	2.67	4.18	0.62	3.30	0.26	15.37

The cost for the Spinning Elliptical Orbit SmallSat is summarized in Table B-10. The cost was estimated for a single Elliptical orbiter. The cost was hard to model using current Team X tools and the cost delta/increase for “formations” is ~\$2M (FY25), good “per unit” estimate. The cost estimate includes the cost for plane change and science operations.

Table B-10. Spinning Elliptical Orbit SmallSat cost summary table in FY25.

	12	12.01	12.02	12.03	12.04	07 and 09	9A.06	7.06	7.08	Total
Phase A Total Cost (\$M)	0.49	0.04	0.26	0.00	0.18	0.00	0.00	0.00	0.00	0.49
Phase B Total Cost (\$M)	1.85	0.22	0.44	0.41	0.78	0.03	0.03	0.00	0.00	1.88
Phase C Total Cost (\$M)	5.53	0.26	0.42	3.72	1.13	0.25	0.25	0.00	0.00	5.78
Phase D1 Total Cost (\$M)	2.84	0.34	0.17	1.72	0.60	0.85	0.25	0.60	0.00	3.69
Phase D2 Total Cost (\$M)	0.50	0.02	0.12	0.36	0.00	0.09	0.00	0.09	0.00	0.60
Phase E Total Cost (\$M)	0.00	0.00	0.00	0.00	0.00	3.04	0.09	2.68	0.26	3.04
Development Total (Phases A–D)	11.21	0.88	1.41	6.22	2.70	1.22	0.52	0.70	0.00	12.43
Ops Total	0.00	0.00	0.00	0.00	0.00	3.04	0.09	2.68	0.26	3.04
Total	11.21	0.88	1.41	6.22	2.70	4.26	0.62	3.38	0.26	15.47

The cost for the Areostationary carrier spacecraft is summarized in Table B-11. The cost for carried Areostationary spacecrafts are not included. The cost delta/increase for “formations” is ~\$2M (FY25) for each additional Areostationary spacecraft. This cost estimates include the cost for cruise to Mars, the spiral down, and science.

Table B-11. Areostationary carrier spacecraft cost summary table in FY25.

	12	12.01	12.02	12.03	12.04	07 and 09	9A.06	7.06	7.08	Total
Phase A Total Cost (\$M)	1.62	0.22	0.80	0.00	0.61	0.00	0.00	0.00	0.00	1.62
Phase B Total Cost (\$M)	3.72	0.22	1.00	0.41	2.09	0.15	0.15	0.00	0.00	3.87
Phase C Total Cost (\$M)	9.74	0.52	1.49	3.72	4.01	0.37	0.37	0.00	0.00	10.11
Phase D1 Total Cost (\$M)	4.47	0.34	0.84	1.72	1.56	1.93	0.37	1.56	0.00	6.40
Phase D2 Total Cost (\$M)	0.83	0.12	0.34	0.36	0.00	1.13	0.00	1.13	0.00	1.96
Phase E Total Cost (\$M)	0.00	0.00	0.00	0.00	0.00	8.91	0.14	8.39	0.38	8.91
Development Total (Phases A–D)	20.38	1.42	4.47	6.22	8.28	3.59	0.89	2.69	0.00	23.97
Ops Total	0.00	0.00	0.00	0.00	0.00	8.91	0.14	8.39	0.38	8.91
Total	20.38	1.42	4.47	6.22	8.28	12.50	1.04	11.08	0.38	32.88

B.3.3 ACS

B.3.3.1 Polar Orbit SmallSat

The sizing assumption for the Polar orbit smallsat is that there is 0.32 m² side-on area, 1.36 m² top-down area, a 0.4 × 0.4 × 0.8 m bus and that the panels are 0.4 × 1.5 × 0.002 m. The ACS design is shown in Table B-12. The sensors were sized to meet pointing requirements (greater than typical SmallSat requirements). RWAs are not mounted on spacecraft principle axes.

Table B-12. ACS Design for Polar Orbit SmallSat.

Component Name	Single CBE Mass (kg)	Contingency (%)	Single Mass MEV (kg)	Quantity	Total CBE Mass (kg)	Total MEV Mass (kg)
Star Trackers–Sodern–Mass	1.4	10.0	1.5	1	1.4	1.5
Sun Sensor–Blue Canyon Technologies–linear 4 diode array	0.0	10.0	0.0	8	0.1	0.1
KVH IMU	0.7	10.0	0.8	1	0.7	0.8
Reaction Wheels–Blue Canyon Technologies–RW4	3.1	10.0	3.4	3	9.3	10.2

Design Rationale

- Attitude Control
 - RWAs (3) maintain spacecraft pointing
 - RCS thrusters desaturate wheels
- Attitude Knowledge
 - Star tracker provides absolute attitude knowledge. Sun sensors provides sun vector and spacecraft attitude during safing. An IMU provides high-rate attitude propagation between updates from the Sun and star sensors.
- Attitude Stability
 - RWAs will maintain spacecraft attitude
- Momentum Management

- RWAs control spacecraft momentum resulting from disturbances (namely solar radiation pressure and thruster misalignments). RCS thrusters will perform desaturation maneuvers. Disturbance torques will affect how long the spacecraft can remain before requiring another firing.

Cost

- The Team Xc ACS tool does not contain a cost model. Cost estimates for ACS were generated using Rules of Thumb wraps to the cost of the spacecraft.

Risk

- KVH IMU does not have known space flight heritage, and must be qualified for flight use.

B.3.3.2 Spinning Elliptical Orbit SmallSat

The design assumption for the spinner spacecraft is that there is 0.32 m² side-on area, 1.36 m² top-down area, a 0.4 × 0.4 × 0.8 m bus and that the panels are 0.4 × 1.5 × 0.002 m. The spinner has a cylindrical shape with 1 m diameter and 1.4 m height. The ACS design is summarized in Table B-13. There are 6 Adcole miniature spinning Sun sensors, mounted on per body axis for high coverage. 2 Barnes Horizon Sensors 1 deg, 1 axis, mounted together orthogonally to one another, and 1 KVH 1750 IMU mounted in any orientation but measured precisely relative to the other sensors.

Table B-13. ACS Design for Spinning Elliptical Orbit SmallSat.

Component Name	Single CBE Mass (kg)	Contingency (%)	Single Mass MEV (kg)	Quantity	Total CBE Mass (kg)	Total MEV Mass (kg)
Adcole Miniature Spinning Sun Sensor	0.3	10.0	0.3	6	1.5	1.7
Horizon Sensor	0.1	10.0	0.1	2	0.2	0.2
KVH IMU	0.7	10.0	0.8	1	0.7	0.8

Design Rationale

- Attitude Control
 - RCS thrusters (4) – MR-111C (4.45 N each, 229 s Isp)
 - Canted at 15°
- Attitude Knowledge
 - The combination of digital Sun sensors and horizon sensors provide external estimates of the spacecraft attitude, while an IMU provides high-rate attitude propagation between updates from the Sun and horizon sensors
- Attitude Stability
 - RCS thrusters will maintain the spinning spacecraft attitude to within their deadbanding capability
- Momentum Management
 - RCS thrusters control spacecraft momentum resulting from disturbances (namely solar radiation pressure and thruster misalignments). A lack of reaction wheels eliminates the need for performing desaturation maneuvers. Disturbance torques will affect how long the spacecraft can remain within the thruster deadband or control requirement before requiring another firing.

Cost

- The Team Xc ACS tool does not contain a cost model. Cost estimates for ACS were generated using Rules of Thumb wraps to the cost of the spacecraft.

Risk

- With attitude control entirely performed using thrusters, accurate modeling of the mass properties and disturbance torques is critical to ensuring proper propellant margin.
 - Controllability for TCMs relies on off-pulsing of thrusters
 - Deadbanding prop consumption highly dependent on mass properties, thruster min ibit, Isp during pulsing, and deadband widths (as well as disturbance torques)
- Thruster firing will send vibrations through the booms, possibly causing unwanted or unmeasured effects in the resultant science measurements.
- Vibrations in the booms and fuel slosh will slowly dissipate energy, which will result in additional fuel to maintain the spin and spin axis. This effect is small, but is not able to be computed in the ACS tool.

B.3.3.3 Areostationary SEP spacecraft

The design assumption for the Areostationary SEP spacecraft is that there is a $1 \times 1 \times 1$ m body, and $2.11 \times 6.2 \times 0.0012$ m planes. The ACS design is summarized in Table B-14. The star trackers, IMU, and Sun sensors provide fine sensing capabilities and absolute attitudes. 3 RWAs (Honeywell HR-14s) provide fine pointing for the spacecraft.

Table B-14. Areostationary SEP spacecraft components.

Component Name	Single CBE Mass (kg)	Contingency (%)	Single Mass MEV (kg)	Quantity	Total CBE Mass (kg)	Total MEV Mass (kg)
Star Trackers—Sodern—Hydra	1.4	10.0	1.5	1	1.4	1.5
Sun Sensor—SSBV—Fine	0.1	10.0	0.1	8	0.8	0.9
MIMU	4.1	10.0	4.5	1	4.1	4.5
HR14	8.5	10.0	9.3	3	25.5	28.1
Total	14.1	10.0	15.4	13.0	31.8	35.0

Design Rationale

- Attitude Control
 - RWAs mounted orthogonally on principle axes
 - SEP thrusters used to desaturate wheels
- Attitude Knowledge
 - Star tracker provides absolute attitude knowledge. Sun sensors provides Sun vector and spacecraft attitude during safing. An IMU provides high-rate attitude propagation between updates from the Sun and star sensors.
- Attitude Stability
 - RWAs will maintain spacecraft attitude
- Momentum Management
 - RWAs control spacecraft momentum resulting from disturbances (namely solar radiation pressure and thruster misalignments). RCS thrusters will perform desaturation maneuvers. Disturbance torques will affect how long the spacecraft can remain before requiring another firing.

Cost

- The Team Xc ACS tool does not contain a cost model. Cost estimates for ACS were generated using Rules of Thumb wraps to the cost of the spacecraft.

Risk

- SEP thruster misalignment could significantly impact momentum buildup due to low thrust, high duty cycle nature of SEP

B.3.4 CDH

Data Story for Polar Orbit SmallSat

- Data Generation
 - Limb Infrared Radiometer
 - 4 kbps continuous = 355 megabits/sol
 - NIR Spectrometer
 - 17 kbps continuous but only during day = 777 megabits/sol
 - Radio Occultation
 - 10 Mbits/occultation, 30 occultations/sol = 300 megabits/sol
 - Total 1432 Mbits generated per sol
- Data Transmission
 - 15 minutes per telecom pass, 65 kbits/sec data rate
 - 2 passes/orbit, 13 orbits/sol
 - Total 1521 Mbits can be relayed per sol

All of the science data generated can be relayed to the Mothership.

Data Story for Spinning Elliptical Orbit SmallSat

- Data Generation
 - Magnetometers + Spectrometers + Fields
 - 1 kbps per instrument continuous = ~4 kbps total
 - Total ~340 Mbits generated per sol
- Data Transmission
 - Telecom time averages between 600 and 700 minutes per sol
 - Distributed across many telecom opportunities of varying length
 - 11 kbits/sec data rate
 - Total ~400 Mbits available telecom relay capability per sol

All of the science data generated can be relayed to the Mothership.

Data Story for Areostationary SEP spacecraft

- Data Generation
 - Nine instruments
 - Visible Camera + Nadir IR Spectrometer: average 290 kbps (12 hours), 24 samples/sol, day side only
 - UV spectra: average 10 kbps
 - Magnetometer + Space Weather: average 3.8 kbps
 - Total 16,195 Mbits generated per sol
- Data Transmission
 - Telecom time, 2× 8-hr passes/day, back-to-back
 - 290 kbits/sec data rate

- Total 16,683 Mbits available telecom per sol

All of the science data generated can be sent to Earth.

For the Polar Orbit SmallSat and the Spinning Elliptical Orbit SmallSat, a JPL built Sphinx CDS system will be used

- 2 CubeSat 1U cards (Sphinx + interface)
 - Sphinx for CPU and standard Command and Data functionality
 - Sphinx Interface Card for mission-specific functions, including mission clock
- Contains all the normal CDS functionality
 - Uplink, downlink, intercommunications, storage
- Designed for long-duration deep space applications
- Flight units delivered 2019 to Lunar Flashlight and NeaScout projects

For the Areostationary SEP spacecraft, a JPL built Sphinx CDS system will be used

- 3 CubeSat 1U cards (Sphinx + 2 interface)
 - Sphinx for CPU and standard Command and Data functionality
 - Customized Sphinx Interface Card for mission-specific functions, including mission clock
 - Customized Sphinx Interface Card for Direct To Earth telecom-specific functions
- Contains all the normal CDS functionality
 - Uplink, downlink, intercommunications, storage
- Designed for long-duration deep space applications
- Flight units delivered 2019 to Lunar Flashlight and NeaScout projects

Cost

- General considerations
 - Used Team X cost model tool to generate cost information
 - Model considered CML 3 and recently updated to include Sphinx hardware
 - Incorporated details pertinent to current study
 - Full development cycle for small experiment
 - 3 Flight Models, 3 prototype units, 1 GSE, 1 BTE, spare flight components
 - Labor rates typical of SmallSat projects
- Polar Orbit SmallSat
 - Total cost \$4.7M (FY22) for first unit, RE cost \$1.4M (FY22) per unit
 - Total cost \$5.0M (FY22) for first unit
- Spinning Elliptical Orbit SmallSat
 - Total cost \$4.4M (FY22) for first unit, RE cost \$1.1M (FY22) per unit
 - Total cost \$5.96 (FY25) for first unit
- Areostationary SEP spacecraft
 - Total cost \$8.2M (FY22) for first unit, RE cost \$3.2M (FY22) per unit
 - Total cost \$8.9M (FY25) for first unit

Risk

- Incorporating DTE Radio capability into SmallSat form factor electronics has not previously been done in Team Xc. Porting of the heritage TIF capability is not expected to be challenging, but it is an unknown.
 - The Team X tool does not adequately handle Class D missions
 - The issue is that design level changes do not affect cost
 - The employed solution is to set the Mission Category to Class C. This results in higher cost but is likely more realistic (the cost number in Class D seemed to low).

B.3.5 Propulsion

B.3.5.1 Polar Orbit SmallSat

Design Assumptions

- Single string redundancy
- Will need to deliver a total of 200 m/s for Orbit Plane Change
 - Inclination ± 1.7 deg with drifts of 5 to 10 months
 - $\sim 1/3$ deg per day to ± 45 deg an ± 90 deg new orbital planes
 - Will need to have 25 m/s (minimum) for orbit maintenance
 - Use a COTS CubeSat/SmallSat propulsion system if possible

Design

- Individual Initial Spacecraft Mass: 93.116 kg
- COTS Propulsion Module
- Aerojet MPS-135-8U
 - System Impulse: $>19,360$ Ns
 - System Dry Mass: 5.1 kg
 - System Wet Mass: 14.7 kg
 - Propellant Mass: 9.6 kg
 - Propellant Type: AF-M315E “Green Propellant”
 - Thrusters: 4x GR-M1
 - 1 Thruster on each corner of the propulsion module.
 - Cost: Estimated around \$3M to \$4M (FY20) per unit

Design Rationale

- The study team had margin to maneuver the three spacecraft into their respective operating orbits. Thus to keep mass and cost down, an integrated CubeSat propulsion system was selected.
- The COTS system met of the DV needs of each spacecraft
 - The system also benefits from the use of a green propellant which allowed for better DV capability over its Hydrazine counterpart
- While no units have “officially” flown at the time of writing this, the decadal survey provides a great platform from which to mature this system for the MOSAIC study team’s needs.

Cost

- Estimated around \$3M to \$4M (FY20) per unit for Aerojet MPS-135-8U
- Total Cost = \$16.2M (FY25) for all 3 polar orbiters
 - Assumes JPL procurement burden of 17.5% due to being a COTS product

Option Comparison

- A Vacco Integrated Propulsion System (IPS) was also considered
- The system also uses green monopropellant (similar but different)
- A version of this system has already flown at the time of writing this however the current iteration of this system would need to be revised to adapt it to the heavier spacecraft within this study
 - This leads to the propulsion group to question regarding Vacco’s recent quality control issues which is why it made this study as an option and not the primary propulsion module chosen.

B.3.5.2 Spinning Elliptical Orbit SmallSat

Design Assumptions

- Individual Initial Spacecraft Mass: 235.4 kg
- Monopropellant blow-down hydrazine system
- Total MEV Dry mass 22.5 kg with 9% contingency
- Propellant Load:
 - 64.3 kg Hydrazine, which includes 1.6 kg of residuals
 - 0.146 kg of Helium Pressurant, 33% ullage

Design

- Individual Initial Spacecraft Mass: 235.4 kg
- QTY (2) MR-103G monopropellant hydrazine spin-up thrusters
 - Mounted on the outer ring to provide a single spin-up event
- QTY (4) MR-111C monopropellant hydrazine spin-up thrusters
 - Aft mounted, canted at 15 degrees to provide pitch, roll, and yaw control as well as axial thrust
- Northrop Grumman (formerly ATK/PSI) 80323-1 diaphragm tank
 - 0.59 m diameter tank, 0.65 m long, 7261 in³ total volumetric capacity

Cost

- Propulsion sized for 1 orbiter
- NRE: \$7.157M (FY25)
- RE: \$4.48M (FY25)

Risk

- Qty (4) aft mounted 4N thrusters may pose a controllability issue per ACS
 - This is likely okay for the sake of this study, but additional analysis is recommended
- The allocation for ACS propellant may grow
 - ACS believes that 10 kg will be sufficient, and that can be contained in the current tank
 - Note that there is sufficient available volume in the spacecraft to allow the tank to grow

Additional Comments

- A trade between short loaded STAR-2 type SRM, off the shelf cold gas system such as the VACCO MEPSI, and the MR-103 for spin up could be valuable
 - The SRM may pose an issue for range safety as it would be an energetic material on a rideshare
 - VACCO cold gas “COTS” systems have had valve leakage issues in the past, but because they are self-contained, they may eliminate extra tanks and plumbing
 - Qty (4) VACCO MEPSI cold gas thrusters, mass 0.5 kg each, should be able to spin up a 168 kg wet mass spacecraft
 - Each is self-contained and could be independently mounted on the spacecraft
- Spin-up will likely occur after the main 500 m/s TCM

B.3.5.3 Areostationary SEP spacecraft

Design

- Individual Initial Spacecraft Mass: 1016.25 kg
- SEP Propulsion System
 - QTY 4 Gimballed MaSMi Thruster Strings
 - Team X tool assumes 1800 s and 30 mN thrust.
 - A MaSMi Thruster String includes:

- 1 MaSMi Thruster
- 1 Power Processing Unit (PPU)
- 1 Xenon Flow Controller (XFC)
- Total propulsion MEV Dry mass 85.12 kg with 9% contingency
- Propellant Load: 288.35 kg Xenon

Cost

- NRE: \$13.6M (FY25)
- RE: \$19.6M (FY25)

Risk

- Because the spacecraft grew to over a ton, the time to perform the spiral maneuver is about 8.8 months as opposed to the 3 month time frame proposed by the MOSAIC study team.
 - This assumes that the spiral maneuver is on a single MaSMi string (1 of 4)
- By increasing the number of MaSMi strings used for this maneuver the time can become closer to the 3 months requested by the MOSAIC study team but the propellant load will increase which could have a ripple effect across several systems.

B.3.6 Mechanical

B.3.6.1 Polar Orbit SmallSat

The design of the Polar Orbit SmallSat is shown in Figure B-16 (stowed) and Figure B-17 (deployed).

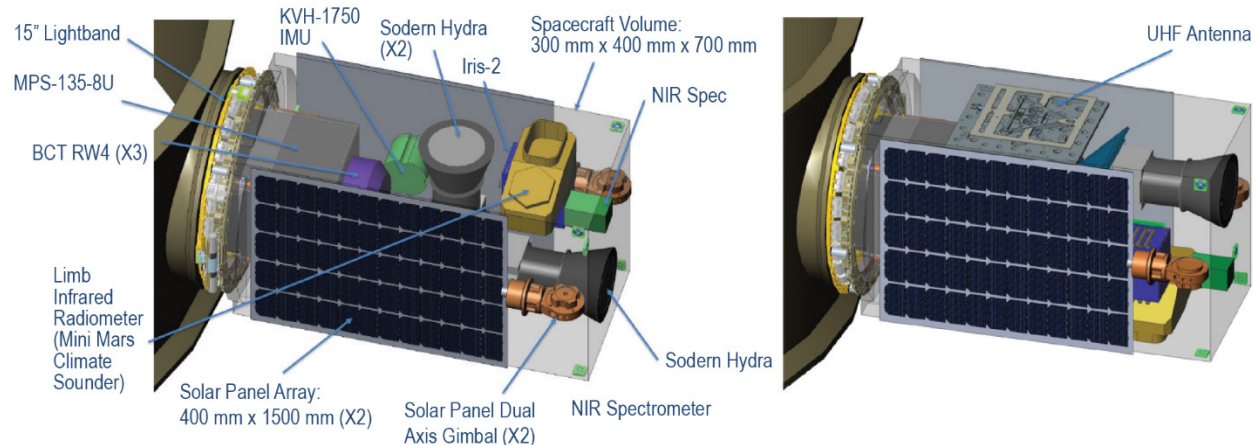

Figure B-16. Polar Orbit SmallSat design (stowed).

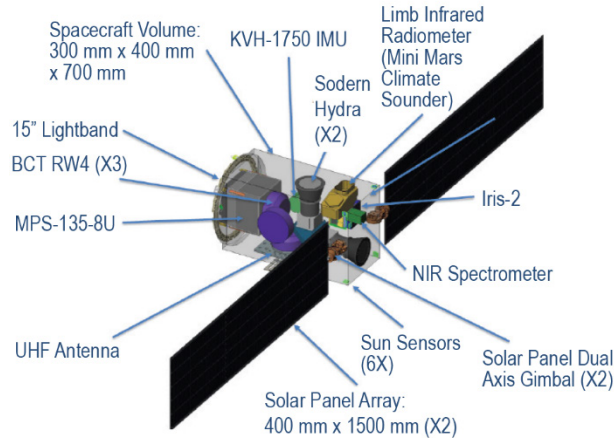

Figure B-17. Polar Orbit SmallSat design (deployed).

Mass Elements

- Primary Structure: 16 kg
 - Main structure, gimbal support, solar array support
 - S/C Envelope is 400 mm x 400 mm x 800 mm
- Cabling: 5.8 kg
- 15" Lightband: 2.6 kg
- Mechanisms: 4.5 kg
 - Gimbals (2 biaxial gimbals), no launch locks for these
 - Solar array release mechanism
 - UHF release mechanism included in UHF mass

Cost Elements

- Mechanical Lead: \$1000k
- Primary Structure: \$1000k
 - Main structure, gimbal support, solar array support
- Cabling: \$200k
- 15" Lightband: \$500k
- Mechanisms: \$1500k
 - Gimbals (2 biaxial gimbals)
 - Solar array launch locks
- Total: \$4M (FY20) per orbiter
- Total: \$4.58M (FY25) per orbiter

B.3.6.2 Spinning Elliptical Orbit SmallSat

The design of the Spinning Elliptical Orbit SmallSat is shown in Figure B-18 (stowed) and Figure B-19 (deployed).



Figure B-18. Spinning Elliptical Orbit SmallSat (stowed).

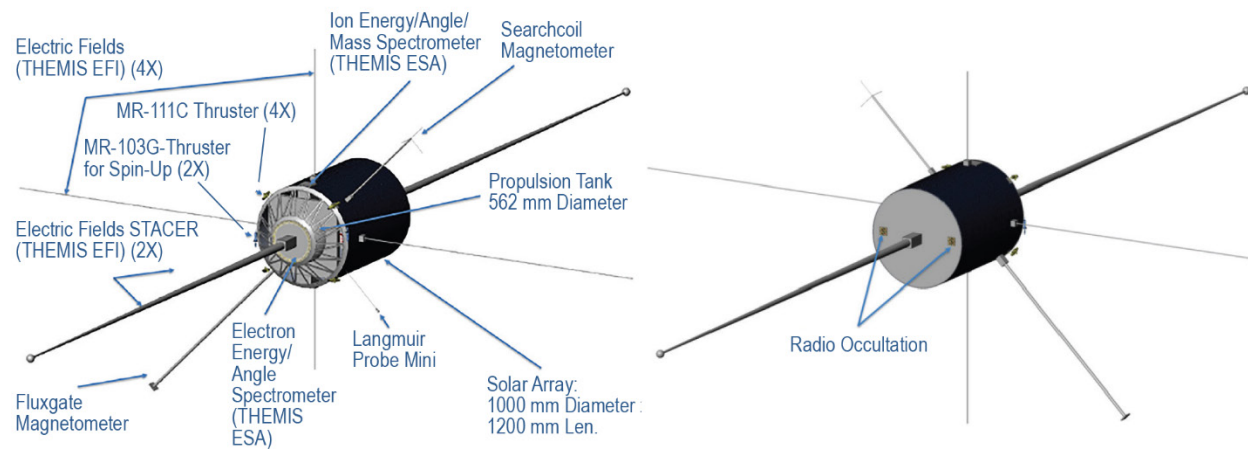

Figure B-19. Spinning Elliptical Orbit SmallSat (deployed).

Mass Elements

- Primary Structure: 50 kg
 - Main structure, instrument support, solar array support
 - S/C Envelope is 1000 mm Dia. × 1500 mm
- Cabling: 9 kg
- 15” Lightband: 2.6 kg
- Mechanisms: None

Cost Elements

- Mechanical Lead: \$1500k
- Primary Structure: \$2000k
 - Main structure, instrument support, solar array support
 - Many instruments and complexity adds to mechanical cost
 - Spinner increases mechanical requirements and analysis
- Cabling: \$500k (many instruments)

- 15” Lightband: \$500k
- Mechanisms: None
- Total: \$4.5M (FY20) per orbiter
- Total: \$5.15M (FY25) per orbiter

B.3.6.3 Areostationary SEP Spacecraft

The design of the Areostationary SEP Spacecraft is shown in Figure B-20 (stowed) and Figure B-21 (deployed).

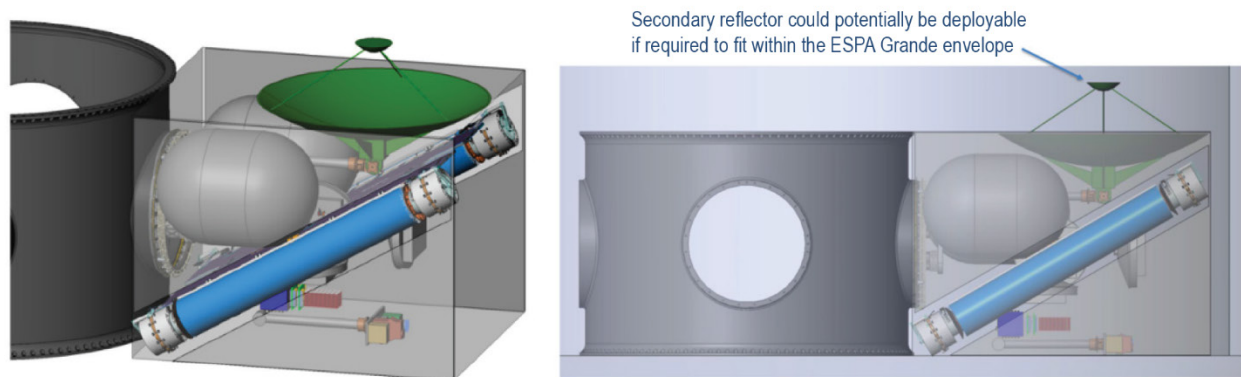

Figure B-20. Areostationary SEP Spacecraft (stowed).

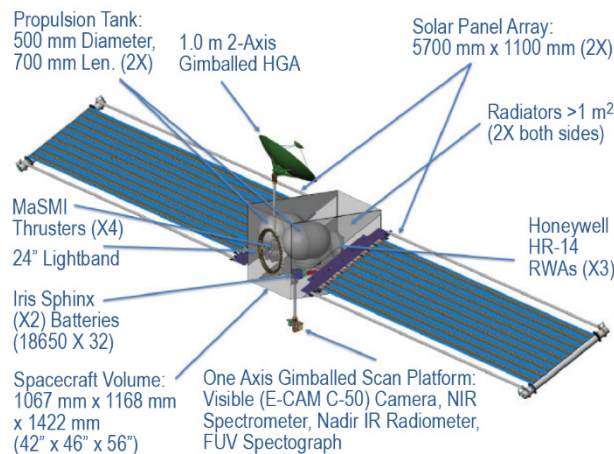

Figure B-21. Areostationary SEP Spacecraft (deployed).

Mass Elements

- Primary Structure: 100 kg
 - Main structure, instrument support, solar array support
 - S/C Envelope is 1000 mm Dia. × 1500 mm
- Cabling: 20 kg
- 24” Lightband: 4.1 kg

- Mechanisms:
 - Gimballed platform: 15 kg
 - HGA mast and pointing: 5 kg
 - Solar Array Gimbal: 4.5 kg

Cost Elements

- Mechanical Lead: \$2000k
- Primary Structure: \$2000k
 - Main structure, gimbal support, solar array support
- Cabling: \$500k
- 24” Lightband: \$500k
- Mechanisms: \$1500k
 - Gimballed platform: \$3000k
 - Will need a launch lock, complex structure
 - HGA mast and pointing: \$1500
 - Does not include HGA antenna
 - Solar Array Gimbal: \$1000k
- Total: \$12M (FY20)
- Total: \$13.75M (FY25)

B.3.7 Telecom

B.3.7.1 Polar Orbit SmallSat

Telecom Design Summary: Total Mass < 3 kg, power consumption ~35 W in full duplex

- The communication system design is at X-Band and UHF and composed of:
 - Transceiver: Iris with SSPA and LNA for X-Band, plus a UHF system (1 TX slice and 1 RX slice). We are assuming a technological development on the Iris.
 - Antennas:
 - X-band: 4 patch elements arrays
 - UHF: antenna loop (like MarCO)
- The receiver is an orbiter (which we assume to be equipped with UHF receiving capabilities, 5 dBi peak gain antenna and decoding for RS and convolutional encoding)
- The X-Band system is used for radio occultation only, while the UHF is used for occultation and telemetry
- The link analysis captures all the key parameters, including attenuation and shows that the system can support radio occultation at X-Band, UHF and telemetry at UHF.

Design Assumptions: Radio Occultation

- Minimum Pt/N0 required is 35 dB
- Frequency: X-Band (8.4 GHz) and UHF (430 MHz)
- Path length: 12000 Km
- Receiver: one of the CubeSat
- Receiver noise factor: 5 dB
- Receiver temperature: 60K
- Circuit loss: 2 dB
- Pointing loss: 3 dB on both RX and TX

Design Assumptions: UHF link

- Minimum E_b/N_0 in downlink (from CubeSat to orbiter) is 4.2 dB (assuming convolutional decoding capabilities on the orbiter)
- Transmitting power from the CubeSat is 1 W and the antenna loop (MarCO heritage) has a peak gain of 5 dBi
- 3 dB of pointing loss on both sides are assumed
- Frequency is UHF (430 MHz)
- Receiver noise temperature: ~ 130 K (60 K and a noise factor of 5 dB is assumed)
- Range is 2500 km
- Additional losses (pointing, polarization) are also included.
- Margin: every link (downlink/uplink, best case/worst case) is designed with a margin of at least 3 dB.

The communication system design is a unique X-Band and UHF system composed of:

- Iris radio (with UHF TX and RX) plus SSPA and LNA
 - Mass: 1500 g; Peak power consumption during transmission: 35 W; Receiving power consumption: 13 W; Transmitting power at X-Band: 4 W; Transmitting power at UHF: 1 W; Volume: $10 \times 10 \times 10$ cm; operating temperature: -20 to 65 deg Celsius.
- Flight heritage on CubeSat missions (Example: MarCO1 and 2)
- 1 UHF loop antenna (MarCO heritage)
 - Mass: ~ 500 g
- 1 UHF diplexer
 - Mass: ~ 500 g (approximate)
- 4 patch antenna arrays of 4 elements each (2 for TX and 2 for RX) by JPL
 - Mass: ~ 100 g; Volume: $9.8 \times 9.8 \times 0.7$ cm; Operational temperature: -30 to 85 deg Celsius.
 - Flight heritage on many CubeSat missions (Example: MarCO 1 and 2)

The information on antenna placement is under configuration.

Cost Estimate

- The cost estimate for the components are:
 - Iris radio (with SSPA and LNA): \$1.5M plus \$500K for UHF development
 - Antennas: \$200K for the X-Band and \$100K for the UHF
 - Cables, Diplexers, GSE: \$100K
- Labor for radio and antenna fabrication is included in the antennas cost
- Telecom systems engineering labor is estimated at 0.3 FTE in Phase A, 0.5 FTE in Phase B, C, D
- Total cost: \$2.7M (FY20) per unit
- Total cost: \$3.1M (FY25) per unit

B.3.7.2 Spinning Elliptical Orbit SmallSat

Telecom Design Summary: Total mass < 4 kg, power consumption ~ 37 W in full duplex

- The communication system design is at X-Band and UHF and composed of:
 - Transceiver: Iris with SSPA and LNA for X0-Band, plus a UHF system (1 TX slice and 1 RX slice). We are assuming a technological development on the Iris
 - Antennas:
 - X-band: 4 patch elements arrays
 - UHF: 2 antenna loop (like MarCO)

- The receiver is an orbiter (which we assume to be equipped with UHF receiving capabilities, 5 dBi peak gain antenna and decoding for RS and convolutional encoding)
- The X-Band system is used for radio occultation only, while the UHF is used for occultation and telemetry
- The link analysis captures all the key parameters, including attenuation and shows that the system can support radio occultation at X-Band, UHF and telemetry at UHF.

Design Assumptions: Radio Occultation

- Minimum Pt/N0 required is 35 dB
- Frequency: X-Band (8.4 GHz) and UHF (430 MHz)
- Path length: 12000 km
- Receiver: one of the CubeSat
- Receiver noise factor: 5 dB
- Receiver temperature: 60 K
- Circuit loss: 2 dB
- Pointing loss: 3 dB on both RX and TX

Design Assumptions: UHF link

- Minimum Eb/N0 in downlink (from CubeSat to orbiter) is 4.2 dB (assuming convolutional decoding capabilities on the orbiter)
- Transmitting power from the CubeSat is 1 W and the antenna loop (MarCO heritage) has a peak gain of 5 dBi
- 3 dB of pointing loss on both sides are assumed
- Frequency is UHF (430 MHz)
- Receiver noise temperature: ~130 K (60 K and a noise factor of 5 dB is assumed)
- Range is 6000 km
- Additional losses (pointing, polarization) are also included
- Margin: every link (downlink/uplink, best case/worst case) is designed with a margin of at least 3 dB

The communication system design is a unique X-Band and UHF system composed of:

- Iris radio (with UHF TX and RX) plus SSPA and LNA
 - Mass: 1500 g; Peak power consumption during transmission: 35 W; Receiving power consumption: 13 W; Transmitting power at X-Band: 4 W; Transmitting power at UHF: 1 W; Volume: 10 × 10 × 10 cm; operating temperature: –20 to 65 deg Celsius.
 - Flight heritage on CubeSat missions (Example: MarCO 1 and 2)
- 2 UHF loop antenna (MarCO heritage)
 - Mass: ~500 g
- 1 UHF diplexer
 - Mass: ~500 g (approximate)
- 1 UHF switch
 - Mass: ~500 g (approximate)
- 4 patch antenna arrays of 4 elements each (2 for TX and 2 for RX) by JPL
 - Mass: ~100 g; Volume: 9.8 × 9.8 × 0.7 cm; Operational temperature: –30 to 85 deg Celsius.
 - Flight heritage on many CubeSat missions (Example: MarCO1 and 2)

Information on antenna placement is under configuration.

Cost Estimate

- The cost estimate for the components are:
 - Iris radio (with SSPA and LNA): \$1.5M plus \$500K for UHF development

- Antennas: \$200K for the X-Band and \$200K for the UHF
- Cables, Diplexers, Switch, GSE: \$110K
- Labor for radio and antenna fabrication is included in the antennas cost
- Telecom sys engineering labor is estimated at 0.3 FTE in Phase A, 0.5 FTE in Phase B, C, D
- Total cost: \$2.8M (FY20) per unit
- Total cost: \$3.2M (FY25) per unit

B.3.7.3 Areostationary SEP Spacecraft

Telecom Design Summary:

- The communication system design is at Ka-Band (downlink) and X-Band (downlink/uplink) composed of:
 - Transceiver: SDST
 - Amplifier: 250 W TWTA (Ka-Band) and 20 W TWTA (X-Band) and LNA
 - X-band diplexer
 - 3 switches
 - Antennas:
 - HGA: double feed at X and Ka-Band
 - MGA: X-Band
 - LGA: X-Band
- The receiver DSN 34 m
- The link analysis captures all the key parameters, including attenuation and shows that the system can support radio occultation at X-Band, UHF and telemetry at UHF.

Design Assumptions

- Minimum Eb/N0 in downlink 0.1 dB (Turbo 1/6, long frame). Uplink is uncoded (9.6 dB)
- Transmitting power is 250 W at Ka-Band and 25 W at X-band
- 3 dB of pointing loss is assumed
- Frequency is:
 - Ka-Band (32 GHz) and X-band (8.4 GHz) for downlink
 - X-Band (7.1 GHz) for uplink
- Range is 400,000,000 km
- NF is 3 dB
- Additional losses (pointing, polarization) are also included
- Margin: every link (downlink/uplink, best case/worst case) is designed with a margin of at least 3 dB

The communication system design is a unique Ka-Band and X-Band system composed of:

- SDST Ka/X down/ X up
- Ka-Band TWTA: 250 W of RF power, 555 W of consumption
- X-Band TWTA: 25 W of RF power, 56 W of consumption
- Diplexer
- 3 switches
- LGA
- MGA
- HGA: 1 m parabolic dish

The cost estimate has been done using the Team X cost model

- Total cost: \$23.8M (FY20)
- Total cost: \$27.3 (FY25)

B.3.8 Power

Design Assumptions

- 29-30% efficient triple junction GaAs solar cells
- Li-Ion 18650 type cells used in the batteries
- CubeSat COTS power electronics or high heritage single string JPL power electronics, as appropriate
- Areostationary SEP spacecraft's relatively high power requirements and SEP requiring 32-100 V inputs necessitate a standard (non-CubeSat based) power subsystem design

Design Array:

- SolAero ZTJ cells
- ~29% efficient at BOM
- Circular Polar
 - Maximum off-point: 10 degrees
 - 2-axis gimballed wings
- Elliptical
 - Maximum off-point: 10 degrees
 - Fixed cylindrical solar panel covering spacecraft
- Areostationary
 - Sun pointed
 - Two 1-axis gimballed Roll Out Solar Array (ROSA) wings

Design Battery:

- Panasonic NCR-18650B battery cells
 - Max cell voltage capped at 4.1 V to reduce lifetime degradation
 - Assuming 2.8 Ah BOL capacity per string (for given voltage and current range)
 - Assuming 15% capacity degradation due to calendar and cycling fade
- Circular Polar and Elliptical
 - Cell string length to provide operating voltage range = 12.0-16.4 V
- Areostationary
 - Cell string length to provide operating voltage range = 24.0-32.8 V

Battery Design:

- Circular Polar
 - 16 total cells
 - Cells configured into eight strings, with four cells per string
 - BOL capacity = 140 Wh
 - EOL capacity = 120 Wh
- Elliptical
 - 32 total cells
 - Cells configured into eight strings, with four cells per string
 - BOL capacity = 282 Wh
 - EOL capacity = 240 Wh
- Areostationary

- 80 total cells
- Cells configured into ten strings, with eight cells per string
- BOL capacity = 829 Wh
- EOL capacity = 704 Wh

Design: Electrical Power System Electronics

Polar Orbit SmallSat and Spinning Elliptical Orbit SmallSat

- GomSpaceP60 Electrical Power System (EPS)
- System provides the following:
 - Nine switchable power distribution channels with overcurrent protection
 - 3.3 V, 5 V, and 12 V secondary voltage outputs
 - Up to six PV inputs
 - Up to 2 A on each input
 - Max power-point tracking on each input
 - Communication over I2C

Areostationary SEP Spacecraft

- SMAP heritage single string design
- PBC: general power bus control
- AIPS: solar array and battery interface
- MREU: 1553 I/F with CDS
- GID: prop drive electronics
- PSS: power switch slice
- HPCU: housekeeping power converter unit for power subsystem
- CEPCU: Compute Element power converter unit

Cost

- Polar Orbit SmallSat:
 - Total cost: \$1.554M (FY20) per unit
 - Total cost: \$1.78M (FY25) per unit
- Spinning Elliptical Orbit SmallSat:
 - Total cost: \$2.2M (FY20) per unit (larger battery and array) than Polar Orbit SmallSat
 - Total cost: \$2.52M (FY25) per unit
 - Assumptions
 - Based on previous CubeSat studies
 - Includes procurements and labor
- Areostationary SEP spacecraft:
 - Total cost: \$10M (FY20)
 - Total cost: \$11.5 (FY25)

Risk

- Significant likelihood cost will increase
 - Polar Orbit SmallSat and Spinning Elliptical Orbit SmallSat: we have no good CubeSat cost model that has been vetted
 - Areostationary SEP spacecraft: Team X tool was used to generate costs but no programmatic information was developed or provided for level of effort cost estimation
- The Areostationary SEP spacecraft's ROSA panels provide a challenge if using ZTJ solar cells due to cell and cover glass rigidity and the rolled stowed panel configuration. Mitigations:
 - Careful layout of the ZTJ cells to avoid cell and cover glass fracture

- Use of flexible cover glass materials coupled with IMM 3 cells
- SolAero IMM 3 cells (thinner and more flexible than ZTJ cells) conducive to rolled pane configuration when stored
 - ~32% efficient at BOM

Option Comparison

- Polar Orbiting SmallSat and Spinning Elliptical Orbit SmallSat are expected to be the same basic design with CubeSat power electronics and array and battery capabilities sized to missions specific energy requirements
- Areostationary SEP spacecraft is a single string subsystem design with a matured SMAP-like power subsystem architecture due to higher power and voltage requirements

B.3.9 Thermal

All 3 options use a similar thermal design approach: cover majority of S/C with MLI, expose silver Teflon radiators to reject heat, and add heaters (and PRTs) to provide replacement heat. There are small variations in cost/effort based on size/power loads/hardware cost. Some variation in the costing tool are dependent on using “interplanetary cruise” or “Mars orbiter”. While the costs are similar, there are slight variation in phasing/effort, but this is probably within the accuracy of the costing tool (< 5%).

B.3.9.1 Polar Orbit SmallSat

Design

- 3-axis stabilized spacecraft with MLI, Radiator, and Thermostatically Controlled Heaters
- Thermostatically Controlled Heaters
- Total Heaters Power
 - 0 W CBE, Prop warmup/Maneuvers
 - 15.4 W CBE, Safe Modes
- Radiator
 - Size: 0.404 m²
 - Silver Coated Teflon Surface
- MLI insulate SC from external environment
- Thermistors for Bus Health and Safety Monitoring

Design Rationale

- Sized Radiator for Worst Case Dissipative Load:
 - MODE: Science/Eclipse, and Telecom = 143 W
- Sized Heater for “Safe Mode” dissipative load case
 - No Prop, Payload, and low telecom case = 68 W

Cost

- Thermal Control System = \$1.9M (FY20) for 1 unit
 - NRE: \$760K
 - RE: \$1150K
- Total
 - Total cost: \$4.21M (FY20) for 3 units
 - Total cost: \$4.82M (FY25) for 3 units

Assumes “Interplanetary-cruise” option

B.3.9.2 Spinning Elliptical Orbit SmallSat

Design

- Spinning spacecraft with MLI, Radiator, and Thermostatically Controlled Heaters
- Thermostatically Controlled Heaters:
 - Two thermal control zones (top and bottom cap)
 - Four thermostats per zones
- Total Heaters Power
 - 0 W CBE, Cruise
 - 29.3 W CBE, Safe Modes
 - 2.9 W CBE, Operational Modes
- Radiator
 - Size: 0.254 m²
 - Use available end-cap surfaces (normal of surface perpendicular to sun)
 - Silver Coated Teflon Surface
- MLI Surface:
 - End Caps of Cylinder only, ~2 kg
- Thermistors for Bus Health and Safety Monitoring

Design Rationale

- Sized Radiator for Worst Case Dissipative Load:
 - MODE: Science/Eclipse, and Telecom (70 W CBE * 1.3) = 90 W
 - Contingency per design principles
- Sized Heater for “Safe Mode” dissipative load case
 - No Prop, Payload, and low telecom case (35 W CBE * 0.9) = 30 W
 - Knockdown per standard JPL Thermal practice

Cost

- Thermal Control System = \$1.96M (FY20) for 1 unit
 - NRE: \$1010K
 - RE: \$950K
- Total
 - Total cost: \$2.91M (FY20) for 2 units
 - Total cost: \$3.33M (FY25) for 2 units

Assumes “Orbiter -Mars” option

Risk

Need to understand any off-pointing tolerances and possible impact to radiator heat rejection capability

B.3.9.3 Areostationary SEP spacecraft

Design

- 3-axis stabilized spacecraft with MLI, Radiator, and Thermostatically Controlled Heaters
- Radiator

- Size: 1.835 m²
- May have to separate radiator surfaces to different faces of S/C bus
- Silver Coated Teflon Surface
- Total Heaters Power
 - 0 W CBE, During SEP burns
 - 184.4 W CBE, Safe Modes and Low Power Science
- Thermostatically Controlled Heaters:
 - 5 thermal control zones (4 thermostats per zones)
- Standard MLI layup to insulate from external environment
- Thermistors for Bus Health and Safety Monitoring

Design Rationale

- Sized Radiator for Worst Case Dissipative Load:
 - MODE: SEP Burn at Earth = 645 W
 - Assumed 88% SEP efficiency
- Sized Heater for “Safe Mode” dissipative load case
 - No Prop, Payload, and low telecom case = 172 W (* 90% = 155 W)
- Assume reduced heater power (compared to calculation tool)
 - 10% SEP at Earth
 - 30% SEP at Mars
 - 50% Telecom DTE & Science Station keeping
 - 100% All other Science Modes

Cost

- Thermal Control System = \$2.0M (FY20) for 1 Areo (not a SmallSat)
 - NRE: \$1.0M
 - RE: \$1.0M
- Assumes “Orbiter-Mars” option
- Total
 - Total cost: \$2.0M (FY20)
 - Total cost: \$2.3M (FY25)

B.3.10 GDS

MOS/GDS costs are only given for the Areostationary SEP spacecraft. Costs for the Polar Orbit SmallSat and the Spinning Elliptical Orbit SmallSat elements will be included as part of the MOSAIC Mothership design study in Team X since they communicate through the Mothership (see Appendix B.4).

Design assumptions for Areostationary SEP spacecraft

- Common GDS across all Areostationary SEP spacecraft, similar Command/Telemetry dictionaries across all spacecraft
- Common teams where possible across all spacecraft:
 - RT OPS (ACES, MDOT), Sequencing, Planning, DSN Scheduling
- 3 deployed (small) ships have shared spacecraft analysis teams
 - For this design they are black boxes, so assuming these are simple spacecraft with simple instrument complements
 - Perform all ORTs post launch (i.e., full team comes in post launch)

- Spacecraft analysis team involved in planning and command activities
- Downlink from Mars has 2× 8-hour passes (back to back) daily for large spacecrafts, smaller ships piggyback on those passes via MSPA. This assumes that they can return their collected data in <6 hours each.

Design for Areostationary SEP spacecraft

- Use mission adapted version of the standard AMMOS GDS tools and Services (Sequene and Planning, Mission Control, Instrument Ops)
 - Common dictionaries where possible, assuming smaller spacecraft will have reduced version of large spacecraft dictionary
 - Assumes FSW based upon JPL Core FSW (or another standard FSW already known to be compatible with AMMOS tools)
 - Common project wide services used where possible (Network/Sys Admin, CM, etc.)
- Hardware
 - Deploy Single MSA for all spacecraft
 - Test Beds (4): 1 for large spacecraft, 3 for smaller spacecraft to support unique instances for each smaller S/C (maybe replaced with unique VM images) but currently budgeting as H/W
 - ATLO (3): 1 for large spacecraft, 2 for smaller spacecraft to support concurrent testing of 2 spacecraft

The cost breakdown is shown in Table B-15. In general, the costs appear closer to New Frontier class mission than any SmallSat mission. The cost is driven by the number of instruments, complexity of the large spacecraft, and the number of small spacecrafts (3) being deployed and operating. The GDS costs may be able to be reduced if we can minimize hardware deliveries and instead operate more with Virtual Machines, hosted on servers. This requires a change in how we handle testbeds, ATLO, and the MSA. The concept is reasonable. The cost model doesn’t support this concept at present.

Table B-15. Cost breakdown for Areostationary SEP spacecraft.

Total Costs	7	8.5	8.5	11	4	39	6	Duration (months)		
\$K by Phase BY 2025	B	C1	C2/C3	D1	D2	E	F	Total Dev	Total Ops	Total A–F
07 MOS	\$1597.03	\$2790.83	\$4560.67	\$7790.93	\$4315.47	\$34272.00	\$336.19	\$21054.94	\$34608.19	\$55663.13
09A Fit Sys GDS	\$2328.64	\$4213.66	\$6776.75	\$6026.95	\$2311.88	\$4722.62	\$210.61	\$21657.87	\$4933.23	\$26591.10
09B SDS/IDS	\$238.76	\$1060.76	\$994.81	\$1781.21	\$551.79	\$9826.04	-	\$4627.33	\$9826.04	\$14453.37
								\$47340.14	\$49367.46	\$96707.60

Risk

- There is a lot of complexity that has been glossed over and minimized in a first cut through this concept.
- Schedule is likely too short for development for all of the elements going into this mission, this in turn will drive costs which are frequently tied to schedule.

B.3.11 Planetary Protection

This is a Category III mission according to the official NASA Planetary Protection guidelines, “NPR 8020.12C Planetary Protection Provisions for Robotic Extraterrestrial Missions.” Category III includes flyby and/or orbiter missions to targets of significant interest relative to the process of chemical evolution and/or the origin of life or for which scientific opinion provides a significant chance of contamination, which would jeopardize a future biological experiment or exploration program(s).

The following Planetary Protection requirements will need to be addressed:

- Documentation
 - Request for Planetary Protection Mission Categorization
 - Planetary Protection Plan
 - Subsidiary Plans:
 - Biological Contamination Analysis Plan
 - Microbiological Assay Plan
 - Microbial Reduction Plan
 - Planetary Protection Implementation Plan
 - Pre-Launch Planetary Protection Report
 - Post-Launch Planetary Protection Report
 - Extended Mission Planetary Protection Report (only required for extended mission)
 - End-of-Mission Planetary Protection Report
- Periodic formal and informal reviews with the NASA Planetary Protection Officer (PPO), including:
 - Project Planetary Planning Review (PPO Option)
 - Pre-Launch Planetary Protection Review
 - Launch Readiness Review
 - Others as negotiated with the PP Officer, typically coinciding with major project reviews
- Impact Avoidance:
 - Probability of impact of Mars by the launch vehicle (or any stage thereof) shall not exceed 10^{-4}
 - The probability of entry into the Martian atmosphere and impact on the surface of Mars shall not exceed the following levels for the specified time periods:
 - 10^{-2} for the first 20 years from date of launch
 - 5×10^{-2} for the period of 20 to 50 years from date of launch
 - If probability of Mars impact exceeds requirement then:
 - Total (all surfaces, including mated, and in the bulk of non-metals) bioburden at launch of all hardware 5×10^5 viable spores
 - Organic Inventory: An itemized list of bulk organic materials and masses used in launched hardware
 - Organic Archive: A stored collection of 50 g samples of organic bulk materials of which 25 kg or more is used in launched hardware
- Spacecraft assembled in Class 100,000 / ISO Class 8 (or better) clean facilities, with appropriate controls and procedures
- Biological Contamination Control:
 - Bioassays to establish the microbial bioburden levels
 - Independent verification bioassays by NASA Planetary Protection Officer

Implementing Procedures

- Preparation of the required PP documentation

- Periodic formal and informal reviews with the NASA PPO
- Trajectory biasing
- Analyses:
 - Probability of impact of Mars by the launch vehicle
 - Probability of impact of Mars by the spacecraft during the prime mission
 - Spacecraft microbial burden estimation at launch
 - Entry heating and break-up analysis (also known as the Burn & Break-up or B&B analysis)
- Spacecraft assembly performed in Class 100,000 / ISO Class 8 (or better) clean facilities, with appropriate controls and procedures
- Microbial burden Reduction:
 - Alcohol-wipe cleaning
 - Precision cleaning
 - Heat microbial reduction (HMR)
 - Vapor H₂O₂ microbial reduction (VHPMR)

Subsystem Design Requirement

- Orbital lifetime approach:
 - Trajectory must be biased to meet probability of impact requirements
- Biological cleanliness approach:
 - Launch vehicle fairing, PAF, upper stage must be cleaned/microbially reduced to 1000 spores/m²
 - All hardware must be compatible with damp-swab sampling
 - All hardware must be compatible with alcohol-wipe cleaning
 - Use of HMR &/or VHPMR for hardware items with large surface area and not demonstrated to be sterilized on entry

Cost

Options 1 (Polar Orbit SmallSat) and 2 (Spinning Elliptical Orbit SmallSat):

- Flight system will not meet orbital lifetime requirement (due to low periapsis)
- Entry heating and break-up analysis will demonstrate that most of the flight system hardware will be sterilized on entry
- Where possible documentation and reviews costs will be carried by the Mothership
- Includes the following activities required for a Mars Orbiter mission not meeting orbital lifetime:
 - Includes minimum PP documentation and review support (cost primarily to be carried by the Mothership)
 - Includes required analyses
 - Bioassay sampling of:
 - All flight system hardware surfaces that will not sterilize on entry, or are a recontamination risk to hardware that will not sterilize on entry
 - Bulk bioassay sample of key/driving materials that will not sterilize on entry
 - Assembly facilities and ground support equipment that are a recontamination risk
 - Launch vehicle hardware
- Limited microbial reduction procedures required for hardware, as the majority of hardware should be sterilized on entry. If required, the cost of performing the microbial reduction procedures to be carried by hardware subsystems.
- The costs of biobarriers/bioshields and HEPA filters, if required, to be carried by hardware subsystems.
 - Some of the development costs may be covered under technology development

Option 3 (Areostationary SEP spacecraft) – Stand alone:

- Flight system should meet orbital lifetime requirement
 - Cruise trajectory and aerobraking are biased to meet probability of impact requirements
- Includes the following activities required for a Mars Orbiter mission meeting orbital lifetime:
 - Includes all PP documentation and reviews

Option 3 (Areostationary SEP spacecraft) – Pieces only:

- Flight system should meet orbital lifetime requirement
 - Cruise trajectory and aerobraking are biased to meet probability of impact requirements
- Includes the following activities required for a Mars Orbiter mission meeting orbital lifetime:
 - Includes minimum PP documentation and review support (cost primarily to be carried by the Mothership)
 - Includes required analyses

The cost summary for option 1 with 3 Polar Orbit SmallSats is shown in Table B-16.

Table B-16. PP cost summary for option 1 with 3 Polar Orbit SmallSats.

Development Phase	FTE (years)	Cost (FY25 K\$)
Non-recurring	1.15	416
Recurring	7.45	2745
Total	8.60	3162

The cost summary for option 2 with 2 Spinning Elliptical Orbit SmallSats is shown in Table B-17.

Table B-17. PP cost summary for option 2 with 2 Spinning Elliptical Orbit SmallSats.

Development Phase	FTE (years)	Cost (FY25 K\$)
Non-recurring	1.15	416
Recurring	4.98	1830
Total	6.12	2247

The cost summary for option 3 with 1 Areostationary SEP spacecraft (later called Areostationary Carrier) carrying 3 SmallSats is shown in Table B-18.

Table B-18. PP cost summary for option 3 with 1 Areostationary SEP spacecraft carrying 3 SmallSats.

Development Phase	FTE (years)	Cost (FY25 K\$)
Non-recurring	1.113	423.3
Recurring	2.326	881.2
Total	3.439	1304.5

Risk

- Options 1 & 2:
 - Entry heating and break-up analysis may indicate that no flight system hardware will be sterilized on entry, therefore requiring cleaning and microbial reduction procedures and additional bioassay sampling not currently planned (~\$2-5 M cost to project)
 - 500,000 total spores may need to be shared across spacecraft in mission rather than giving each spacecraft its own allocation (~\$2-5 M cost to project)
 - Genomic inventory sampling may be required (~\$1-3 M cost to project)
- Option 3:
 - Allowable probability of impact may need to be shared across spacecraft in the mission rather than giving each spacecraft its own allocation
 - Would probably require the mission to switch to a biological cleanliness approach to PP compliance

B.3.12 Cost

Design Assumptions

- Fiscal Year: 2025
- Mission Class: D
- Cost Category: Small
- Schedule (months per phase):
 - A –7; B –7; C –17; D –15; E –40
- Wrap Factors
 - Phases A-D Reserves 50%: Not calculated on LV and Tracking costs
 - Phases E-F Reserves 25%: Not calculated on LV and Tracking costs
- Raw Contract Cost presented in the following slides should be assumed as the final cost with no discounts provided for additional units.
- Options with more than 2 instruments (Aero, Elliptical), additional Payload Management and Systems Engineering costs were calculated to accommodate for the integration, management and systems engineering of multiple instruments.

Cost Drivers

- Spacecraft drives the cost of the development with Mechanical/Structures, C&DH, ACS and Propulsion (see the subsystems reports)
- In-house development labor is one of the main drivers

Potential Cost Savings

- Look for commercial spacecraft development for more competitive pricing
- Seek vendors with space qualified flight heritage

Potential Cost Uppers

- Spacecraft development from a vendor that has little to no experience may cause a schedule impact, thus increase costs
- Added procurement burden for all in-house development and contracts (17.5%)
- Not being able to share the cost of the LV payload due to destination

Cost Risks

- Only one cubesat mission, MarCO, has flown to Mars. MarCO had high heritage with limited payload capability. First-time development for sophisticated SmallSats to Mars have higher than usual cost and schedule risks.

Cost Estimation Methodology for spacecraft contract cost

- Team Xc made estimates for WBS 6+10 costs if using a spacecraft vendor
- Assumed that the MAX cost would be the Team Xc cost estimate
- Assumed that the MIN cost would be only RE on the Team Xc cost estimate (40%)
- Assumed a triangle distribution, as is common in cost estimation, between the MIN and MAX costs
- From the MEDIAN cost, subtracted 5% for insight/oversight and 17.5% for procurement burden to estimate the 50th percentile spacecraft contract cost that may be given by a spacecraft vendor
- Unique requirements, which may be more prevalent for an interplanetary spacecraft, will drive the contract cost to the higher end of the range

The FY25 cost for the Polar Orbit SmallSat for 1 unit for Phases A–F is \$113M. The WBS detail breakdown is provided in Table B-19.

Table B-19. WBS breakdown for FY25 cost of Polar Orbit SmallSat (1 unit) for Phases A-F.

	A-D	E-F	A-F Cost
	1	Spacecraft	Total
1 Project Management	\$2.41	\$0.35	\$2.76
2 Systems Engineering	\$4.9	\$0.00	\$4.9
2.06 Planetary Protection	1.3		1.3
3 Safety and Mission Assurance	\$1.50	\$0.00	\$1.50
4 Science/Technology	\$1.15	\$0.49	\$1.64
5 Payload(s)	\$8.4	\$0.0	\$8.4
Radiometer	\$8.25		\$8.3
NIR Spectrometer	\$0.13		\$0.1
6 Flight System/Spacecraft	\$31.5	\$0.0	\$31.5
6.01 Flight System Project Management	\$1.45	\$0.00	\$1.45
6.02 Flight System Systems Engineering	\$1.42	\$0.00	\$1.42
Spacecraft	\$28.6	\$0.0	\$28.60
6.04 Power	\$1.8		\$1.8
6.05 C&DH	\$5.0		\$5.0
6.06 Telecom	\$3.1		\$3.1
6.07 Structures (includes Mech. I&T)	\$4.6		\$4.6
6.08 Thermal	\$2.2		\$2.2
6.09 Propulsion	\$5.4		\$5.4
6.10 ACS	\$5.2		\$5.2
6.12 Spacecraft Software	\$1.4		\$1.4
7 Mission Operations System (MOS)	\$3.5	\$4.8	\$4.3
8 Launch (cost not included)			
9 Ground Data Systems (GDS)	\$2.3	\$0.1	\$2.4
10 System Integration, Assembly, Test & Check	\$3.6		\$3.6
12.0 MD and Nav	\$11.2		\$11.2
Subtotal	\$70.5	\$5.7	\$76.2
Reserves 50% A-D; 25% E-F	\$35.2	\$1.4	\$36.7
Total Cost with Reserve	\$105.7	\$7.1	\$112.9

The FY25 cost for the Polar Orbit SmallSat for 3 units for Phases A-F is \$199.1M. The WBS detail breakdown is provided in Table B-20.

Table B-20. WBS breakdown for FY25 cost of Polar Orbit SmallSat (3 units) for Phases A-F.

	A-D	E-F	A-F Cost
	3	Spacecraft	Total
1 Project Management	\$4.78	\$0.69	\$5.46
2. Systems Engineering	\$10.3	\$0.00	\$10.3
2.06 Planetary Protection	3.1		3.1
3 Safety and Mission Assurance	\$2.97	\$0.00	\$2.97
4 Science/Technology	\$2.28	\$0.97	\$3.25
5 Payload(s)	\$15.2	\$0.0	\$15.2
Radiometer	\$14.85		\$14.9
NIR Spectrometer	\$0.38		\$0.4
6 Flight System/Spacecraft	\$63.6	\$0.0	\$63.6
6.01 Flight System Project Management	\$2.94	\$0.00	\$2.94
6.02 Flight System Systems Engineering	\$2.87	\$0.00	\$2.87
Spacecraft	\$57.8	\$0.0	\$57.79
6.04 Power	\$3.2		\$3.2
6.05 C&DH	\$8.0		\$8.0
6.06 Telecom	\$5.6		\$5.6
6.07 Structures (includes Mech. I&T)	\$8.2		\$8.2
6.08 Thermal	\$4.8		\$4.8
6.09 Propulsion	\$16.2		\$16.2
6.10 ACS	\$9.4		\$9.4
6.12 Spacecraft Software	\$2.5		\$2.5
7 Mission Operations System (MOS)	\$3.5	\$4.8	\$8.3
8 Launch (cost not included)			
9 Ground Data Systems (GDS)	\$2.3	\$0.1	\$2.4
10 System Integration, Assembly, Test & Check	\$7.2		\$7.2
12.0 MD and Nav	\$15.2		\$15.2
Subtotal	\$127.3	\$6.5	\$133.8
Reserves 50% A-D; 25% E-F	\$63.7	\$1.6	\$65.3
Total Cost with Reserve	\$191.0	\$8.2	\$199.1

The FY25 cost for the Spinning Elliptical Orbit SmallSat for 1 unit for Phases A-F is \$164M. The WBS detail breakdown is provided in Table B-21.

Table B-21. WBS breakdown for FY25 cost of Spinning Elliptical Orbit SmallSat (1 unit) for Phases A-F.

	A-D	E-F	A-F Cost
	1	Spacecraft	Total
1 Project Management	\$3.8	\$0.5	\$4.3
2. Systems Engineering	\$7.0	\$0.0	\$7.0
2.06 Planetary Protection	\$1.3		\$1.3
3 Safety and Mission Assurance	\$2.4	\$0.0	\$2.4
4 Science/Technology	\$1.81	\$0.8	\$2.6
5 Payload(s)	\$20.8	\$0.0	\$20.8
5.01 Management	\$0.94		\$0.9
5.02 Systems Engineering	\$0.9		\$0.9
Fluxgate Magnetometer	\$4.6		\$4.6
Searchcoil Magnetometer	\$3.40		\$3.4
Ion Energy/Angle/Mass	\$4.60		\$4.6
Electron Energy/Angle	\$3.40		\$3.4
Electric Fields	\$2.30		\$2.3
Langmuir Probe	\$0.57		\$0.6
6 Flight System/Spacecraft	\$41.9	\$0.0	\$41.9
6.01 Flight System Project Management	\$1.9	\$0.0	\$1.9
6.02 Flight System Systems Engineering	\$1.9	\$0.0	\$1.9
Spacecraft	\$38.1	\$0.0	\$38.1
6.04 Power	\$2.5		\$2.5
6.05 C&DH	\$4.8		\$4.8
6.06 Telecom	\$3.2		\$3.2
6.07 Structures (includes Mech. I&T)	\$5.2		\$5.2
6.08 Thermal	\$2.2		\$2.2
6.09 Propulsion	\$11.5		\$11.5
6.10 ACS	\$6.9		\$6.9
6.12 Spacecraft Software	\$1.8		\$1.8
7 Mission Operations System (MOS)	\$5.1	\$5.9	\$11.0
8 Launch (cost not included)			
9 Ground Data Systems (GDS)	\$3.4		\$3.4
10 System Integration, Assembly, Test & Check	\$5.7		\$5.7
12.0 MD and Nav	\$11.2		\$11.2
Subtotal	\$103.0	\$7.22	\$110.2
Reserves 50% A-D; 25% E-F	\$51.5	\$1.81	\$53.3
Total Cost with Reserve	\$154.5	\$9.0	\$163.5

The FY25 cost for the Spinning Elliptical Orbit SmallSat for 2 units for Phases A-F is \$217.1M. The WBS detail breakdown is provided in Table B-22.

Table B-22. WBS breakdown for FY25 cost of Spinning Elliptical Orbit SmallSat (2 units) for Phases A-F.

	A-D	E-F	A-F Cost
	2	Spacecraft	Total
1 Project Management	\$5.3	\$0.7	\$6.0
2. Systems Engineering	\$10.1	\$0.0	\$10.1
2.06 Planetary Protection	\$2.2		\$2.2
3 Safety and Mission Assurance	\$3.3	\$0.0	\$3.3
4 Science/Technology	\$2.53	\$1.1	\$3.6
5 Payload(s)	\$29.1	\$0.0	\$29.1
5.01 Management	\$1.32		\$1.3
5.02 Systems Engineering	\$1.3		\$1.3
Fluxgate Magnetometer	\$6.4		\$6.4
Searchcoil Magnetometer	\$4.76		\$4.8
Ion Energy/Angle/Mass	\$6.44		\$6.4
Electron Energy/Angle	\$4.76		\$4.8
Electric Fields	\$3.22		\$3.2
Langmuir Probe	\$0.80		\$0.8
6 Flight System/Spacecraft	\$58.4	\$0.0	\$58.4
6.01 Flight System Project Management	\$2.7	\$0.0	\$2.7
6.02 Flight System Systems Engineering	\$2.6	\$0.0	\$2.6
Spacecraft	\$53.0	\$0.0	\$53.0
6.04 Power	\$3.5		\$3.5
6.05 C&DH	\$6.0		\$6.0
6.06 Telecom	\$4.5		\$4.5
6.07 Structures (includes Mech. I&T)	\$7.2		\$7.2
6.08 Thermal	\$3.3		\$3.3
6.09 Propulsion	\$16.3		\$16.3
6.10 ACS	\$9.7		\$9.7
6.12 Spacecraft Software	\$2.5		\$2.5
7 Mission Operations System (MOS)	\$5.1	\$5.9	\$11.0
8 Launch (cost not included)			
9 Ground Data Systems (GDS)	\$3.4		\$3.4
10 System Integration, Assembly, Test & Check	\$8.0		\$8.0
12.0 MD and Nav	\$13.2		\$13.2
Subtotal	\$138.3	\$7.74	\$146.0
Reserves 50% A-D; 25% E-F	\$69.1	\$1.93	\$71.1
Total Cost with Reserve	\$207.4	\$9.7	\$217.1

The FY25 cost for the Areostationary SEP spacecraft for 1 unit for Phases A-F is \$570M. The WBS detail breakdown is provided in Table B-23.

Table B-23. WBS breakdown for FY25 cost of Areostationary SEP spacecraft (1 unit) for Phases A-F.

	A-D	E-F	A-F Cost
	1	Spacecraft	Total
1 Project Management	\$11.5	\$1.65	\$13.1
2. Systems Engineering	\$18.89	\$0.00	\$18.9
2.06 Planetary Protection	1.3		1.3
3 Safety and Mission Assurance	\$7.1	\$0.00	\$7.1
4 Science/Technology	\$5.5	\$2.33	\$7.8
5 Payload(s)	\$61.3	\$0.00	\$61.3
5.01 Management	\$2.79		\$2.8
5.02 Systems Engineering	\$2.8		\$2.8
Visible Camera	\$0.60		\$0.6
NIR Spectrometer	\$2.30		\$2.3
Nadir Infrared Radiometer	\$3.40		\$3.4
FUV Spectrograph	\$34.40		\$34.4
Fluxgate Magnetometer	\$4.60		\$4.6
Ion Energy/Angle	\$3.30		\$3.3
Electron Energy/Angle Spectrometer	\$2.80		\$2.8
Energetic Ion/Electron	\$3.60		\$3.6
Extreme Ultraviolet	\$0.70		\$0.7
6 Flight System/Spacecraft	\$133.3	\$0.00	\$133.3
6.01 Flight System Project Management	\$6.2	\$0.00	\$6.2
6.02 Flight System Systems Engineering	\$6.0	\$0.00	\$6.0
Spacecraft	\$121.1	\$0.00	\$121.1
6.04 Power	\$11.5		\$11.5
6.05 C&DH	\$8.9		\$8.9
6.06 Telecom	\$23.8		\$23.8
6.07 Structures (includes Mech. I&T)	\$13.7		\$13.7
6.08 Thermal	\$2.3		\$2.3
6.09 Propulsion	\$33.2		\$33.2
6.10 ACS	\$22.0		\$22.0
6.12 Spacecraft Software	\$5.8		\$5.8
7 Mission Operations System (MOS)	\$23.7	\$43.4	\$67.1
8 Launch (cost not included)			
9 Ground Data Systems (GDS)	\$27.2	\$14.9	\$42.1
10 System Integration, Assembly, Test & Check	\$17.7		\$17.7
12.0 MD and Nav	\$20.4		\$20.4
	Subtotal	\$62.2	\$390.1
	Reserves 50% A-D; 25% E-F	\$15.6	\$179.5
	Total Cost with Reserve	\$77.8	\$569.7

The FY25 cost for the Areostationary SEP spacecraft + SmallSats for Phases A-F is \$707M. The SmallSats were assumed as \$28.6M for the first unit, 40% of the first unit (\$11.4M) for each additional unit. These spacecraft elements were not designed by Team Xc. The WBS detail breakdown is provided in Table B-24.

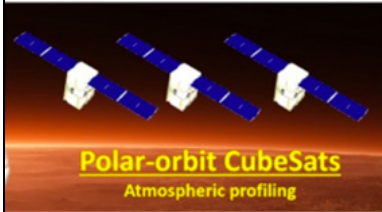
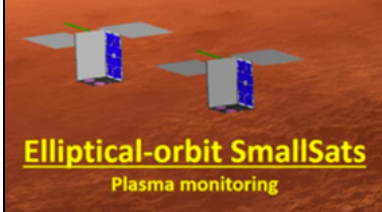

Table B-24. WBS breakdown for FY25 cost for 1 Areostationary SEP spacecraft with SmallSats for Phases A-F.

	A-D	E-F	A-F Cost
	Cost FY25\$M		Total
1 Project Management	\$15.72	\$2.27	\$18.0
2. Systems Engineering	\$24.75		\$24.7
2.06 Planetary Protection	\$1.33		\$1.33
3 Safety and Mission Assurance	\$9.78		\$9.8
4 Science/Technology	\$7.51	\$3.20	\$10.7
5 Payload(s)	\$69.6		\$69.6
5.01 Management	\$3.16		\$3.2
5.02 Systems Engineering	\$3.16		\$3.2
Mothership Spacecraft	\$55.7		\$55.7
Visible Camera	\$0.60		\$0.60
NIR Spectrometer	\$2.30		\$2.30
Nadir Infrared Radiometer	\$3.40		\$3.40
FUV Spectrograph	\$34.40		\$34.40
Fluxgate Magnetometer	\$4.60		\$4.60
Ion Energy/Angle	\$3.30		\$3.30
Electron Energy/Angle Spectrometer	\$2.80		\$2.80
Energetic Ion/Electron	\$3.60		\$3.60
Extreme Ultraviolet	\$0.70		\$0.70
Areostationary SmallSats (3 total)	\$7.6		\$7.56
Visible Camera	\$0.72		\$0.72
NIR Spectrometer	\$2.76		\$2.76
Nadir Infrared Radiometer	\$4.08		\$4.08
6 Flight System/Spacecraft	\$190.0		\$190.0
6.01 Flight System Project Management	\$8.8		\$8.8
6.02 Flight System Systems Engineering	\$8.6		\$8.6
Mothership Spacecraft	\$121.1		\$121.1
6.04 Power	\$11.5		\$11.5
6.05 C&DH	\$8.9		\$8.9
6.06 Telecom	\$23.8		\$23.8
6.07 Structures (includes Mech. I&T)	\$13.7		\$13.7
6.08 Thermal	\$2.3		\$2.3
6.09 Propulsion	\$33.2		\$33.2
6.10 ACS	\$22.0		\$22.0
6.12 Spacecraft Software	\$5.8		\$5.8
Areostationary SmallSats (3 total)	\$51.5		\$51.5
7 Mission Operations System (MOS)	\$23.7	\$43.4	\$67.1
8 Launch (cost not included)			
9 Ground Data Systems (GDS)	\$27.2	\$14.9	\$42.1
10 System Integration, Assembly, Test & Check	\$23.66		\$23.7
12.0 MD and Nav	\$26.4		\$26.4
Subtotal	\$418.3	\$63.7	\$482.0
Reserves 50% A-D; 25% E-F	\$209.1	\$15.9	\$225.1
Total Cost with Reserve	\$627.4	\$79.7	\$707.1

Assumes 40% cost of first unit on mothership for each SmallSat instrument

Passthrough cost assumption from customer team. First unit \$28.6, additional units 40% first unit.

The cost option comparison Table can be seen in Figure B-22.

	Spacecraft (number of units----->)				
	FY25 \$M	1	2	3	4
 <p>Polar-orbit CubeSats Atmospheric profiling</p>	Polar Orbit Total (A-E; 50% Res)	107	151	194	237
	Polar Orbit S/C In-house built Cost (no Res)	35	53	71	89
	Polar Orbit Raw S/C Contract Cost (less insight/oversight + Proc Burden)	16	32	48	64
 <p>Elliptical-orbit SmallSats Plasma monitoring</p>	Elliptical Total (A-E; 50% Res)	158	212	265	319
	Elliptical S/C In-house built Cost (no Res)	48	66	85	104
	Elliptical Raw S/C Contract Cost (less insight/oversight + Proc Burden)	21	42	63	84
 <p>Areostationary SmallSats Weather monitoring, ground telecom</p>	Areo Total (A-E; 50% Res)	568	728	886	1045
	Areo S/C In-house built Cost (no Res)	151	213	274	335
	Areo Raw S/C Contract Cost (less insight/oversight + Proc Burden)	68	136	204	272
	# of units indicated in report				

No NRE savings assumed for the RAW S/C contract cost estimates in the tables above. Vendors will quote the nth unit.

Figure B-22. WBS breakdown for FY25 cost for Areostationary SEP spacecraft with SmallSats for Phases A-F.

Cost Risks

- It is unknown whether NASA will allow SmallSat elements to be a Class D risk posture when part of a large Flagship mission. If they must be a lower risk class, there will be cost growth.
- With a mission cost of \$707M, the Areostationary mothership + SmallSats cannot be classified as Class D
 - This cost is larger than a Discovery mission, which is Class B
 - There will be cost growth for this element to make it Class B

Additional Comments

- Prop system for Polar Orbit is assumed as purchased externally, therefore an additional 17.5% procurement burden was multiplied to the cost estimate received from the Team Xc chair.
- Cost estimates for WBS 6.10 ACS and 6.12 S/C Software were generated using Rules of Thumb wraps to the cost of the spacecraft
- MOS/GDS for Polar and Elliptical are placeholders until the Team X Study
- MDNav has costs reported under WBS 7 and 9 in addition to MOS/GDS numbers. However, total for 7 and 9 for Polar and Elliptical remains as a placeholder

B.4 Team X Design Study Report Summary

B.4.1 Executive Summary

Mission architecture and assumptions

- For Power sizing purposes, the concept of operations of the Mothership was modeled using the power modes shown in Figure B-23.
- In the Science Orbit, for sizing purposes:
 - Worst-case eclipse of 39 minutes was assumed
 - Comm was assumed to be turned on
- Array size was driven by the SEP thrusting cases
- Battery size was driven by the Science – Night – SAR – Eclipse case
- Several modes were initially modeled, but did not drive any power sizing
 - Science – Night – SAR – Sun
 - Science – Night – non-SAR
 - Science – Day – Sounder
- The scenario for calculating science data volumes was modeled separately
- The spacecraft was power-rich in the Science phase

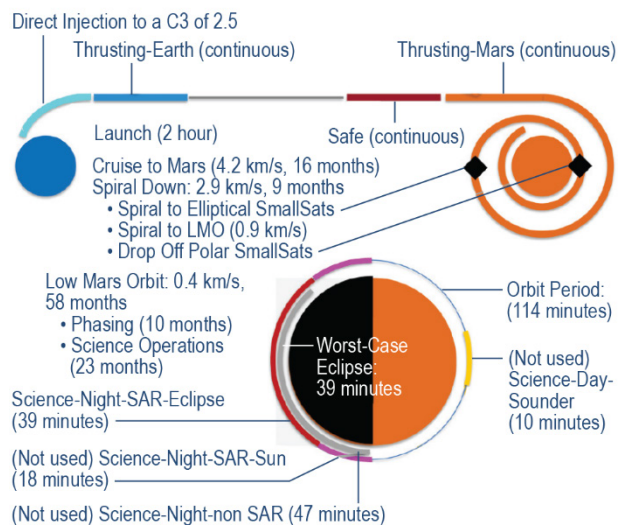

Figure B-23. Mothership concept of operations.

The study examined 2 technical options, each with 2 cost accountings, for a total of 4 options as shown in Table B-25:

- **Option 1** carries **8 instruments** on the Mothership, and only the Mothership is costed
- **Option 2** is the same technical design as Option 1, but the cost accounting includes a full project-level roll-up of **all of the elements** in the constellation
- **Option 3** carries **4 instruments** on the Mothership, and only the **Mothership** is costed
 - It is slimmed-down to fit in a New Frontiers cost bin
- **Option 4** is the same technical design as **Option 3**, but the cost accounting includes a full project-level roll-up of **all of the elements** in the constellation
 - The full project is Flagship-class

Table B-25. MOSAIC Team X option comparison.

	Option 1	Option 2	Option 3	Option 4
# Instruments	8 (counting SAR/Sounder as 1)		4	
What is Mothership sized to carry?	Elliptical and Polar SmallSats			
What is included in cost?	Mothership	Constellation	Mothership	Constellation
Cost Category	Flagship	Flagship	New Frontiers	Flagship* / New Frontiers**
Risk Class	A	A	B	A* / B**
Total Cost (A-F, FY25) w/ 50% Phase A-D and 25% Phase F reserves	\$2601M	\$3931M	\$1401M	\$2792M
Mothership Mass (Wet, 30% JPL margin)	3722 kg		2439 kg	
Stack Mass (Wet, 30% JPL margin on all elements)	5911 kg		4613 kg	
Un-allocated Launch Vehicle margin (Falcon Heavy Recoverable, C3=2.5)	364 kg (6%)		1622 kg (26%)	

*Project-level costs

**Flight element level costs for the Mothership

Conclusions, risks, and recommendations

- This Mothership (and the constellation it is a part of) is technically feasible for both options
 - The designs close technically
 - The entire launch stack fits within the Launch Vehicle allocation, and each flight element has 30% JPL Margin, as per the JPL Design Principles
- The Mothership by itself, with the full instrument complement (and designed to carry SmallSats, but without their cost), is a flagship-class mission
- A “New Frontiers” class Mothership (that still carries un-costed SmallSats) must have a significantly reduced payload to get under a New Frontiers cost cap
- A true “Daughtership-free” option would feature a spacecraft designed without carried mass (and possibly without UHF relay), and would be less massive and less expensive but was not assessed in this Team X design study.

B.4.2 Systems

Power Modes for Option 1 (Mothership), summarized in Table B-26:

- System power modes are used for the purposes of sizing the power subsystem. They represent the ConOps at enough fidelity to model the power sizing cases, and are not necessarily a complete description of the ConOps.
 - The Team X power chair uses these modes to construct sizing scenarios, according to their judgement and in consultation with the Team X systems chair
- The science modes do not form a complete sizing orbit; only “Science – Night – SAR – Eclipse” is used for sizing in the science orbit. The spacecraft was power rich in the science phase.

Table B-26. Power modes for option 1 (Mothership).

Mode Name	Launch	Safe	Thrusting–Earth	Thrusting–Mars	Science–Night–SAR–Eclipse	Science–Night–SAR–Sun	Science–Night–non SAR	Science–Day–Sounder
Duration	2 hrs	24 hrs (continuous)	24 hrs (continuous)	24 hr s(continuous)	39 mins	18 mins	47 mins	10 mins
Location	Earth	Deep Space	Deep Space, 1 AU	Deep Space, 1.39 AU	LMO–Eclipse	LMO–Night, Sun	LMO–Night, Sun	LMO–Day
Driving?	No	No	No	Drives Array size	Drives Battery size	No	No	No
Instruments	None	None	None	None	SAR +5 night instruments	SAR +5 night instruments	5 night instruments	Sounder +7 day/night instruments
Comm	X-band Rcv only	X-band	X-band	X-band	Ka-band UHF	Ka-band UHF	Ka-band UHF	Ka-band UHF

Power Modes for Option 3 (Mothership), summarized in Table B-27.

- The four Science mode names are misnomers, and carry-overs from Option 1; there was no SAR or Sounder on the spacecraft
 - For sizing purposes, only the Eclipse science mode was used
- The spacecraft was power rich in the science phase

Table B-27. Power modes for option 3 (Mothership).

Mode Name	Launch	Safe	Thrusting–Earth	Thrusting–Mars	Science–Night–SAR–Eclipse	Science–Night–SAR–Sun	Science–Night–non SAR	Science–Day–Sounder
Duration	2 hrs	24 hrs (continuous)	24 hrs (continuous)	24 hr s(continuous)	39 mins	18 mins	47 mins	10 mins
Location	Earth	Deep Space	Deep Space, 1 AU	Deep Space, 1.39 AU	LMO–Eclipse	LMO–Night, Sun	LMO–Night, Sun	LMO–Day
Driving?	No	No	No	Drives Array size	Drives Battery size	No	No	No
Instruments	None	None	None	None	2 night instruments	2 night instruments	2 night instruments	4 day/night instruments
Comm	X-band Rcv only	X-band	X-band	X-band	Ka-band UHF	Ka-band UHF	Ka-band UHF	Ka-band UHF

For the purpose of calculating data volumes, the following ConOps was used:

- Option 1 (Mothership)
 - Orbit period: 114 mins
 - P-SAR: 50% duty cycle during the day, 50% duty cycle during the night
 - Sounder: 10% duty cycle during the day, 10% duty cycle during the night
 - Wide angle camera: on during the day, off during the night
 - Limb radiometer: on during the day, on during the night
 - MARLI lidar: on during the day, on during the night
 - Sub-mm sounder: on during the day, on during the night
 - Argus NIR spectrometer: on during the day, off during the night
 - Wind interferometer: on during the day, on during the night
 - FUV/MUV spectrograph: on during the day, on during the night

- Option 3 (Mothership)
 - Orbit period: 114 mins
 - Wide angle camera: on during the day, off during the night
 - Limb radiometer: on during the day, on during the night
 - Argus NIR spectrometer: on during the day, off during the night
 - FUV/MUV spectrograph: on during the day, on during the night

The MOSAIC study team provided the Phase E schedule in Figure B-24, for the whole constellation. It was used to set the Phase E duration for all options at 57 months (58 months post-launch, with the first 1 month post-launch for post-ops checkout considered part of Phase D).

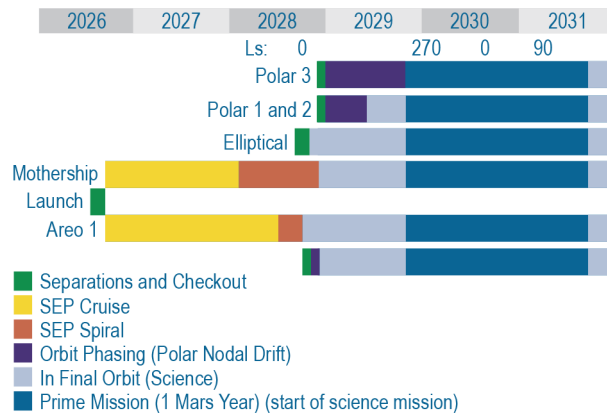

Figure B-24. Project Schedule for Phase E provided by MOSAIC study team.

Project Schedule

- The development schedules for the 4 options differed, depending on the scale of the project in that option, see Table B-28.
 - Note that these are the schedules for the Project; in Option 1 and 3, this consists of just a Mothership. In Option 2 and 4, this is the whole stack, however the other flight elements may have shortened individual development schedules.
- The schedules for Options 1 and 2 are based on rules of thumb for a Flagship class mission, in keeping with the project cost for those two options
- The schedules for Options 3 and 4 are based on rules of thumb for a New Frontiers class mission
 - For Option 3, where only the Mothership is designed, the rules of thumb are used without modification
 - For Option 4, where the New Frontiers class mothership must be integrated with several other SmallSats, the Phase D schedule is lengthened to that of a Flagship class mission, to handle the additional integrations

Table B-28. Project schedule for options 1-4.

Phase	Sub-phase	Description	Option 1		Option 2		Option 3		Option 4	
Project Start Date (KDP-A)			12/1/2018		12/1/2018		6/2/2021		1/2/2021	
A		Project Definition	15		15		12		12	
B		Preliminary Design	15		15		12		12	
C	C1	Design	41	14	41	14	22	11	22	11
	C2	Fabrication		14		14		6		6
	C3	Fabrication Subsystem I&T		13		13		5		5
D	D1	Project I&T	23	19	23	19	18	14	23	19
	D2	Launch Ops		4		4		4		4
E		Operations	57		57		57		57	
F		Closeout	4		4		4		4	

Design assumptions for option 1 (Mothership)

- The Mothership spacecraft’s power and propulsion systems were sized using a SEP mission design provided by the MOSAIC study team
- A ΔV and Xe budget was provided by the MOSAIC study team that included the science phase and included enough information to break the budget into pre- and post-jettison for the SmallSat drop-masses.
 - ΔV budget (assumes 3900 kg dry)
 - Cruise: 4.2 km/s (775 kg Xe)
 - Spiral: 2.8 km/s (475 kg Xe)
 - At Mars: 0.4 km/s (50 kg Xe)
 - Total: 7.5 km/s (1300 kg Xe)
- The trajectory assumes the use of 2 AEPS thrusters (from ARM, the Asteroid Retrieval Mission)
- Power to the EP system at various solar distances was also provided by the MOSAIC study team
 - Nominal 22 kW BOL (@1 AU)
 - 13.6 kW @ 1.27 AU
 - 10.6 kW @ 1.43 AU
 - 11.3 kW @ 1.39 AU

Design assumptions for option 3 (Mothership).

In Option 3, the Mothership spacecraft mass came down considerably, so the trajectory was re-scaled:

- Starting wet mass was set to a value that resulted in 30% JPL dry mass margin for the Mothership, as per JPL Design Principles
 - Mass initial = Mothership wet mass @ 30% JPL margin + Carried SmallSat mass
- Rather than using the Xe mass numbers, the ΔVs were used
- Average per-segment Isp values from Option 1 were calculated by the Team X prop chair, and used for each segment
- EP Power was re-scaled proportional to the starting wet mass:
 - EP Power Option 3 = EP Power Option 1 * (Mass initial / 5175 kg)
 - Note that 5175 kg is the starting mass of the Mothership + carried elements in the trajectory above
- This keeps the acceleration profile the same as in the original trajectory
- This re-scaling approximation uses the (not entirely accurate) assumption that:
 - Thrust is linear with EP power
 - Isp is constant over the used power range

- In fact, for the ARM AEPS thrusters used in this Team X study, neither assumption is quite true
- A new trajectory run would be needed to fully converge this design, but the final design point should not differ dramatically

Instrument FOVs were provided by the MOSAIC study team.

System guidelines

- Option 1 & 2 were set to be a Class A mission, with a mission cost category of “Flagship”, in light of the multi-billion dollar cost
- Option 3 was set to be a Class B mission, with a Mission Cost Category of “Large”, in keeping with its New Frontiers class cost
- Option 4 was the same technical design as Option 3, but the project risk class was Class A and the Mission Cost Category was “Flagship”, since the project as a whole (including SmallSats) was multiple billions of dollars
- However, the subsystem costs for the Mothership were the same as used in Option 3, and thus costed assuming a risk Class B and a Mission Cost Category of “Large”

Design Summary for Option 1 & 2 (Mothership), shown in Figure B-25.

- Instruments
 - P-Band SAR/Sounder Radar
 - Visible Imager
 - Limb Radiometer
 - Wind LIDAR
 - Sub-mm Sounder
 - Near IR Spectrometer
 - Wind Doppler Interferometer
 - FUV/MUV Spectrometer
- CDS
 - Fully dual-string
 - RAD750 avionics
 - NVM to accommodate data storage
- Ground Systems
 - Ground Network = DSN
 - Two 8-hr passes per day
- Telecom
 - 3 m Ka-band HGA, 2-axis gimbale, with two 200 WRF TWTAs
 - 2 X-band LGAs, with two 25 WRF TWTAs
 - 2 UHF low gain helix antennas
 - 2 Universal Space Transponders (USTs)
- ACS
 - 3-axis stabilized
 - Sun sensors, star trackers, IMUs, RWAs, gimbal drive electronics
- Structures
 - Primary Structure Mass MEV= 381 kg
 - Secondary Structure Mass MEV = 30 kg
 - Mechanisms
 - Solar array gimbals (1-axis)
 - HGA gimbals (2-axis)

- Thermal
 - Passive thermal control (MLI, heaters, thermal surfaces)
 - Radiators on SA-facing bus faces
- Power
 - Two deployable ROSA arrays, total area = 79 m²
 - Sized to “Thrusting – Mars” mode
 - Li-Ion Battery
 - Sized for “Science – SAR – Eclipse” mode
- Propulsion
 - EP system with 2x AEPS engines
 - Small Hydrazine RCS system for RW desats and attitude control in safe mode

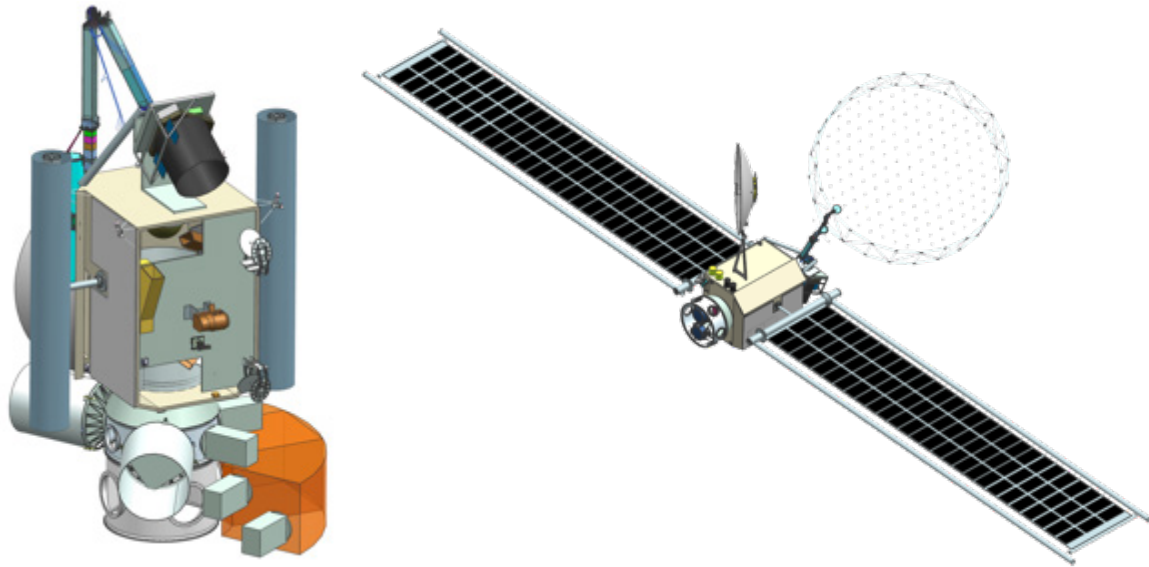

Figure B-25. Design for option 1 & 2 (mothership).

Design Summary for Option 3 & 4 (Mothership), shown in Figure B-26

- Instruments
 - Visible Imager
 - Limb Radiometer
 - Near IR Spectrometer
 - FUV/MUV Spectrometer
- CDS
 - Fully dual-string
 - RAD750 avionics
- Ground Systems
 - Ground Network = DSN
 - Two 8-hr passes per day
- Telecom
 - 1 m Ka-band HGA, 2-axis gimbale, with two 200 WRF TWTAs
 - 2 X-band LGAs, with two 25 WRF TWTAs

- 2 UHF low gain helix antennas
- 2 Universal Space Transponders (USTs)
- ACS
 - 3-axis stabilized
 - Sun sensors, star trackers, IMUs, RWAs, gimbal drive electronics
- Structures
 - Primary Structure Mass MEV= 258 kg
 - Secondary Structure Mass MEV = 20 kg
 - Mechanisms
 - Solar array gimbals (1-axis)
 - HGA gimbals (2-axis)
- Thermal
 - Passive thermal control (MLI, heaters, thermal surfaces)
 - Radiators on SA-facing bus faces
- Power
 - Two deployable ROSA arrays, total area = 53 m²
 - Sized to “Thrusting – Mars” mode
 - Li-Ion Battery
 - Sized for “Science – SAR – Eclipse” mode
- Propulsion
 - EP system with 2x AEPS engines
 - Small Hydrazine RCS system for RW desats and attitude control in safe mode

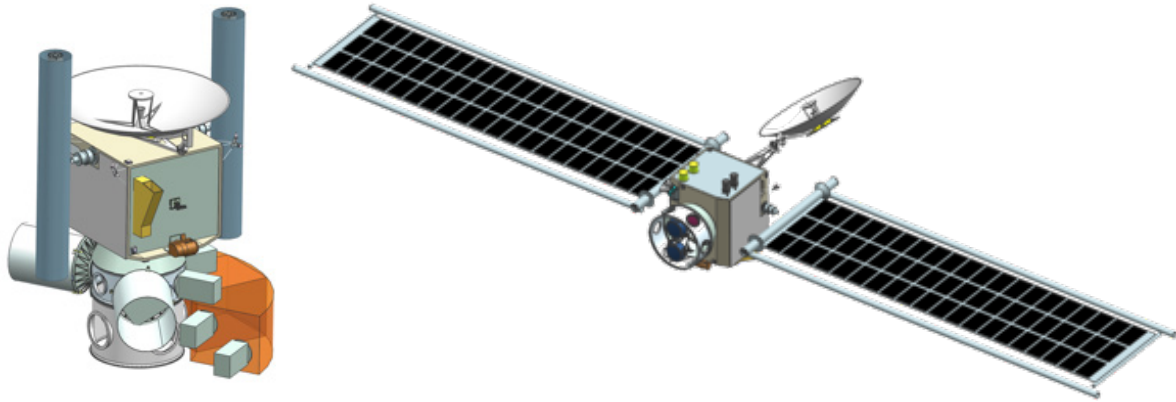

Figure B-26. Design for option 3 & 4 (mothership).

Summaries for option 1 & 2 and 3 & 4 are shown in Tables B-29 and B-30. Note that the science modes are misnamed, but this does not affect the design results.

Table B-29. Systems summary for option 1 & 2 (Mothership).

	Mass Fraction	Mass (kg)	Sub-sys Cont. %	CBE+ Cont. (kg)	Mode 1 Power (W) Launch	Mode 2 Power (W) Safe	Mode 3 Power (W) Thrusting –Earth	Mode 4 Power (W) Thrusting –Earth	Mode 5 Power (W) Science–Night–SAR–Eclipse	Mode 6 Power (W) Science–Night–SAR–Sun	Mode 7 Power (W) Science–Night–non SAR	Mode 8 Power (W) Science–Day–Sounder
Power Mode Duration (hours)					2	24	24	24	0.65	0.3	0.78333	0.16667
Payload on this Element												
Instruments	10%	240.6	30%	312.8	0	0	0	0	317	317	207	327
Payload Total	10%	240.6	30%	312.8	0	0	0	0	317	317	207	327
Additional Elements Carried by this Element												
Carried Elements Total	37%	907.2	0%	907.2	0	0	0	0	0	0	0	0
RSDO Option →												
Spacecraft Bus												
Attitude Control	3%	66.6	10%	73.3	46	112	112	112	109	109	109	112
Command & Data	1%	28.9	17%	33.9	69	69	69	69	69	69	69	69
Power	10%	234.4	29%	301.3	234	234	286	211	260	260	251	261
Propulsion 1 ✓ SEP1	11%	259.1	14%	296.5	0	0	22000	11300	0	0	0	0
Propulsion 2 SEP 2	1%	15.2	26%	19.0	25	25	33	33	1	1	1	1
Propulsion 3 SEP 3	0%	0.0	0%	0.0	0	0	0	0	0	0	0	0
Structures & Mechanisms	19%	452.7	30%	588.5	0	0	0	0	0	0	0	0
Spacecraft-Side Adapter	1%	20.4	30%	26.5								
Cabling	3%	81.6	30%	106.1								
Telecom	3%	70.3	14%	80.2	28	93	93	93	454	454	454	454
Thermal	2%	49.8	30%	64.7	1457	1326	152	152	967	967	976	963
Bus Total		1278.9	24%	1590.1	1860	1860	22746	11971	1860	1860	1860	1860
Spacecraft Total (Dry) without Carried Elements: CBE & MEV		1519.6	25%	1902.9								
Spacecraft Total (Dry) and Carried Elements: CBE & MEV		2426.7	16%	2810.1	1860	1860	22746	11971	2177	2177	2067	2186
Spacecraft and Carried Elements with Contingency:		2810	of total	w/o add pld	2659	2659	25267	13389	3113	3133	2955	3126
Propellant & Pressurant with residuals 1	34%	1495.3		For spacecraft mass=	5175.0		Delta-V, Sys 1	0.0	m/s	residuals=	195.3	kg
Propellant & Pressurant with residuals 2	1%	53.2		For spacecraft mass=	5175.0		Delta-V, Sys 2	0.0	m/s	residuals=	1.3	kg
Spacecraft and Carried Elements Total with Contingency (Wet)		4359										
Margined Allocation for Spacecraft and Carried Elements		4629		Wet mass for prop sizing	4629							
				Dry mass for prop sizing	2810	4628.6723		BOL Power:	24178.1	W		
Dry Mass Allocation: MPV		2173.0						EOL Power:	13080.9	W		
JPL Design Principles Margin		653.4	30%	(MPV–CBE)/MPV								
NASA Margin		270.0	14%	(MPV–MEV)/MPV								

Table B-30. Systems summary for option 3 & 4 (Mothership).

Mass Fraction	Mass (kg)	Sub-sys Cont. %	CBE+ Cont. (kg)	Mode 1 Power (W) Launch	Mode 2 Power (W) Safe	Mode 3 Power (W) Thrusting -Earth	Mode 4 Power (W) Thrusting -Earth	Mode 5 Power (W) Science-Night-SAR-Eclipse	Mode 6 Power (W) Science-Night-SAR-Sun	Mode 7 Power (W) Science-Night-non SAR	Mode 8 Power (W) Science-Day-Sounder
Power Mode Duration (hours)				2	24	24	24	0.65	0.3	0.78333	0.16667
Payload on this Element											
Instruments	2%	36.7	30%	47.7	0	0	0	46	46	46	56
Payload Total	2%	36.7	30%	47.7	0	0	0	46	46	46	56
Additional Elements Carried by this Element											
Carried Elements Total	47%	906.2	0%	906.2	0	0	0	0	0	0	0
RSDO Option →											
Spacecraft Bus											
Attitude Control	3%	54.6	10%	60.1	46	112	112	112	109	109	112
Command & Data	1%	25.2	17%	29.5	63	63	63	63	63	63	63
Power	9%	168.9	28%	216.1	192	192	229	181	196	196	197
Propulsion 1 ✓ SEP1	12%	240.0	13%	271.7	0	0	14284	7338	0	0	0
Propulsion 2 SEP 2	0%	9.3	23%	11.5	25	25	33	33	1	1	1
Propulsion 3 SEP 3	0%	0.0	0%	0.0	0	0	0	0	0	0	0
Structures & Mechanisms	16%	312.1	30%	405.8	0	0	0	0	0	0	0
Spacecraft-Side Adapter	1%	16.5	30%	21.4							
Cabling	3%	57.2	30%	74.4							
Telecom	3%	58.9	14%	67.2	28	93	93	93	454	454	454
Thermal	2%	41.5	30%	53.9	983	852	127	127	515	515	510
Bus Total		984.3	23%	1211.5	1338	1338	14943	7948	1338	1338	1338
Spacecraft Total (Dry) without Carried Elements: CBE & MEV		1021.0	23%	1259.3							
Spacecraft Total (Dry) with Carried Elements: CBE & MEV		1927.2	12%	2165.4	1338	1338	14943	7948	1384	1384	1384
Spacecraft and Carried Elements with Contingency:		2165	of total	w/o addl pld	1914	1914	16654	8944	1979	1979	1979
Propellant & Pressurant with residuals 1	34%	962.6		For spacecraft mass=	3360.0		Delta-V, Sys 1	7500.0	m/s	residuals=	125.7 kg
Propellant & Pressurant with residuals 2	1%	16.0		For spacecraft mass=	3360.0		Delta-V, Sys 2	0.0	m/s	residuals=	0.4 kg
Spacecraft and Carried Elements Total with Contingency (Wet)		3144									
Margined Allocation for Spacecraft and Carried Elements		3345		Wet mass for prop sizing	3345						
				Dry mass for prop sizing	2165	4628.6723	BOL Power:	16170.8	W		
Dry Mass Allocation: MPV (Spacecraft excluding carried elements)		1460.0					EOL Power:	8748.8	W		
JPL Design Principles Margin		439.0	30%	(MPV-CBE)/MPV							
NASA Margin		200.8	16%	(MPV-MEV)/MPV							

Margin and contingency guidelines

- Mass Margins were computed using both JPL and NASA standards
 - Wet Allocation = Sub-allocation for this flight element
 - Normally, this is the Launch Vehicle capability but for a spacecraft in a constellation, we a sub-allocation is used that is back calculated such that our JPL Margin is 30%
 - Dry MPV (Max Possible Value) = Wet Allocation – Propellant & Pressurant
 - Dry CBE (Current Best Estimate) = Sum of spacecraft dry CBE values
 - JPL Design Principles Dry Mass Margin = $(\text{Dry MPV} - \text{Dry CBE}) / (\text{Dry MPV})$
 - JPL Design Principles require a dry mass margin of 30% for designs in Pre-Phase A and A
 - Dry MEV (Maximum Expected Value) = Sum of spacecraft dry MEV values (CBE + contingency)
 - NASA Margin = $(\text{Dry MPV} - \text{Dry MEV}) / (\text{Dry MEV})$
 - See the “Stack Summary” section for a summary of these values for Option 1 & 2 and Option 3 & 4
 - All of the flight elements designed in the JPL Team Xc design study and this JPL Team X design study have 30% JPL Margin, as per the JPL design principles
 - The “Allocation” values are in a sense artificial, calculated such that the element has the required 30% margin
 - This results in a total stack mass that still has un-allocated margin against the Launch Vehicle

Major trades on the mothership

- 1-axis vs 2-axis gimbals for solar arrays (all Options)
 - To keep the solar arrays in full sun with the 3 am/3 pm science orbit and a nadir-pointing requirement would require 2-axis gimbals on the solar arrays
 - However, because the arrays are sized for the EP system, and are therefore significantly oversized for the science orbit, it was decided to give them only 1-axis gimbals (adequate for deep space propulsion), and allow a 45-degree cosine loss in science operations
- 1-axis radar vs. 1-axis nadir deck vs. no articulation (Option 1)
 - To satisfy the MOSAIC science team’s initial science ConOps, the SAR and sounder both needed to operate simultaneously with other nadir-pointed instruments
 - However, the SAR requires a 30-degree cross-track orientation, whereas the sounder must point nadir
 - The SAR and sounder share the same 6 m deployable dish antenna
 - The combination of these constraints meant that either:
 - a) the SAR/sounder needed one axis of articulation, to off-point 30 degrees cross-track, or
 - b) the other nadir-pointing instruments needed to be on a 1-axis scan platform, to stay nadir-pointed while the SAR pointed cross-track
 - In the end, the MOSAIC science team agreed that the sounder could be pointed at the expense of other instruments
 - When the sounder is in operation (10% of the time), the other nadir-facing instruments remain on and collecting data, but they accept a 30 degree off-point, with some loss of science data
 - This means that the radar dish is “twisted” to be 30 degree cross-track when the S/C is nadir-pointed

Conclusions, risks, and recommendations

- This Mothership (and the constellation it is a part of) is technically feasible for both options
 - The designs close technically
 - The entire launch stack fits within the Launch Vehicle allocation, and each flight element has 30% JPL Margin, as per the JPL Design Principles

- The Mothership by itself, with the full instrument complement (and designed to carry SmallSats, but without their cost), is a flagship-class mission
- A “New Frontiers” class Mothership (that still carries un-costed SmallSats) must have a significantly reduced payload to get under a New Frontiers the cost cap

Additional Comments

- Though option 1 and 3 are “Mothership-only” for the purposes of the cost rollup, the Mothership in both options is still designed to carry the masses of the Elliptical and Polar SmallSats, and it is still designed to supply UHF relay for them.
 - It is still a “Mothership”, even if it’s children are not costed
 - A true “Daughtership-free” option would feature a spacecraft designed without carried mass (and possibly without UHF relay), and would be less massive and less expensive

B.4.3 Science

Design requirements

- Two cases were considered for the Mothership: a full configuration with 8 instruments (Option 1) and a smaller mission with 4 instruments (Option 3)
 - Option 1
 - P-band radar
 - Visible camera
 - Thermal IR limb radiometer
 - Wind LIDAR
 - Sub-mm sounder
 - Near-IR spectrometer
 - Wind doppler interferometer
 - FUV/MUV spectrometer
 - Option 3
 - Visible camera
 - Thermal IR limb radiometer
 - Near-IR spectrometer
 - FUV/MUV spectrometer
- For both cases, the instruments were modelled as “simple”, i.e. no significant resource conflicts, little sequencing complexity, and well-known analysis approaches.

Design

- The payload is nominally nadir pointed, with offsets for atmospheric measurements of the limb.
- Occasional maneuvers are required for calibration.
- Systems Notes:
 - Various instruments are pointed off-nadir in various orientations and with various articulations (see Instrument report for diagram), but the S/C maintains a fixed pointing with respect to nadir most of the time
 - The SAR is typically pointed cross track, and a S/C roll is required for the nadir operation of the sounder

The data return values used in this Team X design study are shown in Table B-31.

Table B-31. Data volumes used in Team X design study.

Instrument	Data Return	Option 3
	Option 1	
	Gbits/day	Gbits/day
P-band Radar	9.50E+10	
P-band sounder	4.96E+10	
Visible Camera	6.20E+09	6.20E+09
TIR Limb radiometer	3.00E+08	3.00E+08
Wind LIDAR	3.90E+09	
Sub-mm-Sounder	8.00E+08	8.00E+08
Near IR spectrometer	4.00E+08	
Wind Doppler Interferometer	1.10E+09	
FUV/MUV Spectrometer	1.00E+09	1.00E+09
Polar 1	1.40E+09	1.40E+09
Polar 2	1.40E+09	1.40E+09
Polar 3	1.40E+09	1.40E+09
Elliptical 1	5.00E+08	5.00E+08
Elliptical 2	5.00E+08	5.00E+08
Total bytes/day	2.04E+10	1.69E+09

Cost assumptions

- Standard science team organized around instruments
- Science manager and project scientist included
- 25 month cruise (32 month operation)
- 12 months “training” before orbital insertion
- 6 months phase F (science closeout)

Tables B-32 and B-33 show the cost for option 1 and option 3.

Table B-32. Cost for baseline payload (option 1).

			A	B	C	D	E	F	Total	ABCD
			15.00 M	15.00 M	41.00M	23.00 M	32.00 M	6.00 M	\$K	SUM
			\$K	\$K	\$K	\$K	\$K	\$K		\$K
4	WBS Code	Science	1773.2	7116.6	39151.6	20377.5	103714.7	10761.1	182894.7	68419.0
4.1		Science Management	536.4	1820.6	5760.8	3231.7	10546.3	882.7	22778.5	11349.5
	4.11	Science Office	536.4	1820.6	5760.8	3231.7	10546.3	882.7	22778.5	11349.5
4.2		Science Implementation	1155.2	3984.1	29804.8	14374.7	79571.5	8627.5	137517.8	49318.8
	4.2.1	Participating Scientists	254.6	254.6	2745.7	1587.0	13034.6	1284.1	19160.7	4842.0
	4.2.T	Teams Summary	900.6	3729.4	27059.1	12787.7	66536.9	7343.3	118357.1	44476.8
4.3		Science Support	81.7	1311.9	3585.9	2771.2	13596.8	1250.9	22598.4	7750.7
	4.3.1	Science Data Visualization	38.1	76.2	208.3	116.9	289.6	22.9	751.9	439.5
	4.3.2	Science Data Archiving	0.0	386.5	1056.4	1118.5	4966.8	470.3	7998.5	2561.4
	4.3.3	Instrument Support	0.0	805.7	2202.1	1469.1	5297.0	470.3	10244.2	4476.9
	4.3.4	Science Environmental Characterization	0.0	0.0	0.0	0.0	0.0	0.0	0.0	0.0
	4.3.5	Operations Support	43.5	43.5	119.0	66.8	3043.4	287.4	3603.8	272.9

Table B-33. Cost for reduced payload with 4 instruments (option 3).

			A	B	C	D	E	F	Total	ABCD
			12.00 M	12.00 M	22.00M	18.00 M	32.00 M	6.00 M	\$K	SUM
			\$K	\$K	\$K	\$K	\$K	\$K		\$K
4	WBS Code	Science	695.6	2917.8	10152.0	7248.7	47909.6	4771.4	73695.2	21014.2
4.1		Science Management	220.8	975.4	1955.7	1600.1	7349.2	623.9	12725.1	4752.0
	4.11	Science Office	220.8	975.4	1955.7	1600.1	7349.2	623.9	12725.1	4752.0
4.2		Science Implementation	418.2	1424.2	7246.3	4577.3	34223.6	3569.3	51458.9	13666.0
	4.2.1	Participating Scientists	113.2	113.2	759.0	657.5	6725.3	658.9	9027.1	1642.8
	4.2.T	Teams Summary	305.1	1311.0	6487.3	3919.8	27498.3	2910.4	42431.8	12023.1
4.3		Science Support	56.6	518.2	950.1	1071.3	6336.8	578.1	9511.1	2596.3
	4.3.1	Science Data Visualization	21.8	43.5	79.8	65.3	206.9	16.3	433.7	210.5
	4.3.2	Science Data Archiving	0.0	143.7	263.5	378.9	2223.2	209.0	3218.3	786.1
	4.3.3	Instrument Support	0.0	296.1	542.9	574.8	2364.7	209.0	3987.6	1413.9
	4.3.4	Science Environmental Characterization	0.0	0.0	0.0	0.0	0.0	0.0	0.0	0.0
	4.3.5	Operations Support	34.8	34.8	63.9	52.3	1542.0	143.7	1871.5	185.8

Comments on cost

- Cost Drivers
 - Cost is directly related to the number of instruments and duration
- Potential cost uppers
 - Complex operations or unexpected analysis challenges could incur cost risk

B.4.4 Instruments

Instrument design options 1 & 2 are shown in Table B-34. Note that the visible and NIR instruments operate during day time only.

Table B-34. Instrument design option 1 & 2.

Instrument Name	# Units	Mass			Power		Per Instrument Percentage On in Each Power Mode (give % or input "S" if in Standby)										Power in Each Power Mode									
		Mass / Unit CBE (kg)	Mass CBE (kg)	Cont.	Total + cont. (kg)	Op. Power CBE (W) per Instrument	Standby Power (W) per Instrument	Mode 1	Mode 2	Mode 3	Mode 4	Mode 5	Mode 6	Mode 7	Mode 8	Mode 9	Mode 10	Mode 1	Mode 2	Mode 3	Mode 4	Mode 5	Mode 6	Mode 7	Mode 8	
								Launch	Safe	Thrusting-Earth	Thrusting-Mars	Science-Night-SAR-Eclipse	Science-Night-SAR-Sun	Science-Night-nonSAR	Science-Day-Sounder	TBD	TBD	Launch	Safe	Thrusting-Earth	Thrusting-Mars	Science-Night-SAR-Eclipse	Science-Night-SAR-Sun	Science-Night-nonSAR	Science-Day-Sounder	
		241 kg	30%	312.8			2 hr	24 hr	24 hr	24 hr	.7 hr	.3 hr	.8 hr	.2 hr	0 hr	0 hr	0	0	0	0	317	317	207	327		
P-Band SAR/Sounder Radar (SMAP)	1	92.0 kg	92.0	30%	119.6	110 W			0%	0%	0%	0%	100%	100%	0%	100%	0%	0%	0.0	0.0	0.0	0.0	110.0	110.0	0.0	110.0
Visible Imager (MARCI)	1	0.5 kg	0.5	30%	0.624	7 W	4 W	0%	0%	0%	0%	0%	0%	0%	100%	0%	0%	0.0	0.0	0.0	0.0	0.0	0.0	0.0	7.0	
Limb Radiometer (Mars Climate Sounder)	1	9.0kg	9.0	30%	11.7	18 W			0%	0%	0%	0%	100%	100%	100%	100%	0%	0%	0.0	0.0	0.0	0.0	18.0	18.0	18.0	18.0
Wind LIDAR (MARLI)	1	45.0 kg	45.0	30%	58.5	91 W			0%	0%	0%	0%	100%	100%	100%	100%	0%	0%	0.0	0.0	0.0	0.0	91.0	91.0	91.0	91.0
Sub-mm Sounder (Mars Compass)	1	26.9 kg	26.9	30%	35	50 W			0%	0%	0%	0%	100%	100%	100%	100%	0%	0%	0.0	0.0	0.0	0.0	50.0	50.0	50.0	50.0
Near IR Spect (Thoth Argus)	1	0.2 kg	0.2	30%	0.299	3 W			0%	0%	0%	0%	0%	0%	100%	0%	0%	0.0	0.0	0.0	0.0	0.0	0.0	0.0	2.5	
Wind Doppler Interferometer (MIGHTI)	1	40.0 kg	40.0	30%	52	20 W			0%	0%	0%	0%	100%	100%	100%	100%	0%	0%	0.0	0.0	0.0	0.0	20.0	20.0	20.0	20.0
FUV/MUV Spect (IUVS-MAVEN)	1	27.0 kg	27.0	30%	35.1	28 W			0%	0%	0%	0%	100%	0%	100%	100%	0%	0%	0.0	0.0	0.0	0.0	28.0	20.0	28.0	28.0

Instrument design option 3 & 4 (with a reduced set of Mothership instruments) are shown in Table B-35. Duty cycles are shown in power modes. Removed instruments are shown in red text.

Table B-35. Instrument design option 3 & 4.

Instrument Name	# Units	Mass			Total + cont. (kg)	Power		Per Instrument Percentage On in Each Power Mode (give % or input "S" if in Standby)										Power in Each Power Mode							
		Mass / Unit CBE (kg)	Mass CBE (kg)	Cont.		Op. Power CBE (W) per Instrument	Standby Power (W) per Instrument	Mode 1	Mode 2	Mode 3	Mode 4	Mode 5	Mode 6	Mode 7	Mode 8	Mode 9	Mode 10	Mode 1	Mode 2	Mode 3	Mode 4	Mode 5	Mode 6	Mode 7	Mode 8
								Launch	Safe	Thrusting-Earth	Thrusting-Mars	Science-Night-SAR-Eclipse	Science-Night-SAR-Sun	Science-Night-nonSAR	Science-Day-Sounder	TBD	TBD	Launch	Safe	Thrusting-Earth	Thrusting-Mars	Science-Night-SAR-Eclipse	Science-Night-SAR-Sun	Science-Night-nonSAR	Science-Day-Sounder
		37 kg	30%	47.7			2 hr	24 hr	24 hr	24 hr	.7 hr	.3 hr	.8 hr	.2 hr	0 hr	0 hr	0	0	0	0	46	46	46	56	
P-Band SAR/Sounder Radar (SMAP)	0	92.0 kg	0.0	30%	0	110 W		0%	0%	0%	0%	0%	0%	0%	0%	0%	0.0	0.0	0.0	0.0	0.0	0.0	0.0	0.0	
Visible Imager (MARCI)	1	0.5 kg	0.5	30%	0.624	7 W	4 W	0%	0%	0%	0%	0%	0%	100%	0%	0%	0.0	0.0	0.0	0.0	0.0	0.0	0.0	7.0	
Limb Radiometer (Mars Climate Sounder)	1	9.0kg	9.0	30%	11.7	18 W		0%	0%	0%	0%	100%	100%	100%	100%	0%	0%	0.0	0.0	0.0	0.0	18.0	18.0	18.0	18.0
Wind LIDAR (MARLI)	0	45.0 kg	0.0	30%	0	91 W		0%	0%	0%	0%	0%	0%	0%	0%	0%	0.0	0.0	0.0	0.0	0.0	0.0	0.0	0.0	
Sub-mm Sounder (Mars Compass)	0	26.9 kg	0.0	30%	0	50 W		0%	0%	0%	0%	0%	0%	0%	0%	0%	0.0	0.0	0.0	0.0	0.0	0.0	0.0	0.0	
Near IR Spect (Thoth Argus)	1	0.2 kg	0.2	30%	0.299	3 W		0%	0%	0%	0%	0%	0%	100%	0%	0%	0.0	0.0	0.0	0.0	0.0	0.0	0.0	2.5	
Wind Doppler Interferometer (MIGHTI)	0	40.0kg	0.0	30%	0	20 W		0%	0%	0%	0%	0%	0%	0%	0%	0%	0.0	0.0	0.0	0.0	0.0	0.0	0.0	0.0	
FUV/MUV Spect (IUVS-MAVEN)	1	27.0 kg	27.0	30%	35.1	28 W		0%	0%	0%	0%	100%	100%	100%	100%	0%	0%	0.0	0.0	0.0	0.0	28.0	28.0	28.0	28.0

Table B-37. Instrument costs for option 3.

Instrument Name	# Units	Mass		Cont.	Total + cont. (kg)	Power		Cost Model Results—with inflation and burden included									
		Mass / Unit CBE (kg)	Mass CBE (kg)			Op. Power CBE (W) per Instrument	Standby Power (W) per Instrument	Model 1 st Unit (\$M)—inflated to specified FY	Override	1 st Unit (\$M)	Model Addit. Unit (\$M)	Override	Cost of Addit. Unit (\$M)	Total Cost (\$M)	Total Non-Rec (\$M)	Total Rec (\$M)	
			37 kg	30%	47.7										\$114	66	48
P-Band SAR/Sounder Radar (SMAP)	0	92.0 kg	0.0	30%	0	110 W		0		0		0		0	\$0	0	0
Visible Imager (MARCI)	1	0.5 kg	0.5	30%	0.624	7 W	4 W	6		6	0		0	0	\$6	3	2
Limb Radiometer (Mars Climate Sounder)	1	9.0kg	9.0	30%	11.7	18 W		35		35	0		0	0	\$35	20	14
Wind LIDAR (MARLI)	0	45.0 kg	0.0	30%	0	91 W		0		0		0		0	\$0	0	0
Sub-mm Sounder (Mars Compass)	0	26.9 kg	0.0	30%	0	50 W		0		0		0		0	\$0	0	0
Near IR Spect (Thoth Argus)	1	0.2 kg	0.2	30%	0.299	3 W		3		3	0		0	0	\$3	2	1
Wind Doppler Interferometer (MIGHTI)	0	40.0kg	0.0	30%	0	20 W		0		0		0		0	\$0	0	0
FUV/MUV Spect (IUVS-MAVEN)	1	27.0 kg	27.0	30%	35.1	28 W		71		71	0		0	0	\$71	41	30

Instrument cost

- Cost Drivers
 - Large instrument suite
 - Several heavy and power hungry instruments
 - Radar, LiDAR, Wind interferometer, and FUV/MUV Spectrometer all \$70M or more
- Potential Cost Savings
 - Option 3 explored the most direct cost savings, reducing the number and types of instruments
 - Other possible options are using smaller, less capable instruments
- Potential Cost Uppers
 - If the requirements to meet the science grew such that the instruments need to grow incapability, etc.

The instrument cost option comparison can be seen in Table B-38.

Table B-38. Instrument cost option comparison.

Option	Mass (kg)	Cost (\$M)	Instruments	Comments
1	313	487	Full 8 instrument suite	Multiple instruments per science objective
3	48	114	Minimal instrument set (4)	Investigate the same science objectives with a minimal set of instruments

B.4.5 Mission Design

Cost estimates are provided for the following 4 scenarios. Note that costs are only reflective of Mothership operations, do not include any other elements of constellation:

1. Only Mothership, see Table B-39.
2. Mothership with constellation, see Table B-40.
3. Reduced Mothership, see Table B-41.
4. Reduced Mothership with constellation, see Table B-42.

Table B-39. Cost for option 1, Mothership only.

	12	12.01	12.02	12.03	12.04	07 and 09	9A.06	7.06	7.08	Total
Phase A Total Cost (\$M)	2.80	0.51	1.24	0.00	1.05	0.00	0.00	0.00	0.00	2.80
Phase B Total Cost (\$M)	5.65	0.51	1.28	1.00	2.86	0.17	0.17	0.00	0.00	5.83
Phase C Total Cost (\$M)	14.39	1.41	2.81	4.18	5.99	0.41	0.41	0.00	0.00	14.80
Phase D1 Total Cost (\$M)	5.58	0.65	1.19	1.94	1.80	2.21	0.41	1.80	0.00	7.79
Phase D2 Total Cost (\$M)	0.86	0.14	0.31	0.41	0.00	0.79	0.00	0.79	0.00	1.65
Phase E Total Cost (\$M)	0.00	0.00	0.00	0.00	0.00	9.92	0.23	9.16	0.53	9.92
Development Total (Phases A–D)	29.28	3.22	6.84	7.52	11.69	3.58	0.99	2.58	0.00	32.86
Ops Total	0.00	0.00	0.00	0.00	0.00	9.92	0.23	9.16	0.53	9.92
Total	29.28	3.22	6.84	7.52	11.69	13.50	1.22	11.75	0.53	42.78

Table B-40. Cost for option 2, Mothership with constellation.

	12	12.01	12.02	12.03	12.04	07 and 09	9A.06	7.06	7.08	Total
Phase A Total Cost (\$M)	3.70	0.46	1.82	0.00	1.43	0.00	0.00	0.00	0.00	3.70
Phase B Total Cost (\$M)	7.64	0.46	1.98	0.89	4.31	0.15	0.15	0.00	0.00	7.79
Phase C Total Cost (\$M)	18.96	1.26	3.93	3.72	10.05	0.37	0.37	0.00	0.00	19.33
Phase D1 Total Cost (\$M)	6.82	0.59	1.67	1.72	2.84	3.21	0.37	2.84	0.00	10.03
Phase D2 Total Cost (\$M)	0.96	0.12	0.48	0.36	0.00	0.91	0.00	0.91	0.00	1.87
Phase E Total Cost (\$M)	0.00	0.00	0.00	0.00	0.00	9.95	0.21	9.18	0.57	9.95
Development Total (Phases A–D)	38.09	2.90	9.88	6.69	18.62	4.64	0.89	3.75	0.00	42.73
Ops Total	0.00	0.00	0.00	0.00	0.00	9.95	0.21	9.18	0.57	9.95
Total	38.09	2.90	9.88	6.69	18.62	14.60	1.10	12.92	0.57	52.68

Table B-41. Cost for option 3, reduced Mothership.

	12	12.01	12.02	12.03	12.04	07 and 09	9A.06	7.06	7.08	Total
Phase A Total Cost (\$M)	2.39	0.41	1.09	0.00	0.89	0.00	0.00	0.00	0.00	2.39
Phase B Total Cost (\$M)	4.44	0.41	1.12	0.42	2.48	0.17	0.17	0.00	0.00	4.61
Phase C Total Cost (\$M)	6.69	0.75	1.58	0.78	3.58	0.41	0.41	0.00	0.00	7.10
Phase D1 Total Cost (\$M)	3.30	0.48	0.88	0.50	1.44	1.85	0.41	1.44	0.00	5.14
Phase D2 Total Cost (\$M)	0.59	0.14	0.31	0.14	0.00	0.79	0.00	0.79	0.00	1.38
Phase E Total Cost (\$M)	0.00	0.00	0.00	0.00	0.00	9.92	0.23	9.16	0.53	9.92
Development Total (Phases A–D)	17.41	2.19	4.99	1.84	8.39	3.22	0.99	2.22	0.00	20.63
Ops Total	0.00	0.00	0.00	0.00	0.00	9.92	0.23	9.16	0.53	9.92
Total	17.41	2.19	4.99	1.84	8.39	13.14	1.22	11.39	0.53	30.55

Table B-42. Cost for option 4, reduced Mothership with constellation.

	12	12.01	12.02	12.03	12.04	07 and 09	9A.06	7.06	7.08	Total
Phase A Total Cost (\$M)	3.16	0.37	1.59	0.00	1.20	0.00	0.00	0.00	0.00	3.16
Phase B Total Cost (\$M)	6.46	0.37	1.76	0.71	3.62	0.15	0.15	0.00	0.00	6.61
Phase C Total Cost (\$M)	10.61	0.68	2.22	1.99	5.72	0.37	0.37	0.00	0.00	10.98
Phase D1 Total Cost (\$M)	6.82	0.59	1.67	1.72	2.84	3.21	0.37	2.84	0.00	10.03
Phase D2 Total Cost (\$M)	0.96	0.12	0.48	0.36	0.00	0.91	0.00	0.91	0.00	1.87
Phase E Total Cost (\$M)	0.00	0.00	0.00	0.00	0.00	9.95	0.21	9.18	0.57	9.95
Development Total (Phases A–D)	28.02	2.13	7.72	4.79	13.38	4.64	0.89	3.75	0.00	32.66
Ops Total	0.00	0.00	0.00	0.00	0.00	9.95	0.21	9.18	0.57	9.95
Total	28.02	2.13	7.72	4.79	13.38	14.60	1.10	12.92	0.57	42.62

Mission design cost considerations

- Cost Drivers
 - Requirement to work in conjunction with constellation ups cost.
- Potential Cost Savings
 - Costs of Option 3 lower because of compressed development timeline in Phases A-D
- Potential Cost Uppers
 - Cost very sensitive to degree of coordination required between spacecraft
 - Current cost estimated assuming the least amount of coordination (loose relative knowledge required, but no tight control of relative orbits or coordinated maneuvering)

A comparison of the mission design cost option can be seen in Table B-43.

Table B-43. Mission design cost option comparison.

Option	Delta V (m/s)	Cost A–D (\$M)	Orbit/Trajectory	Comments
1	–	29.28	–	
2	–	38.09	–	
3	–	17.41	–	
4	–	28.02	–	

B.4.6 Configuration

Configuration design requirements and assumptions

- Requirements
 - Nadir pointing and gimballed instruments
 - ESPA ring permanently attached to spacecraft
 - Main AEPS engines housed inside ring
 - Launch Vehicle: Falcon Heavy Recoverable
 - Payload:
 - Wind Lidar – MARLI
 - Sub-mm Sounder – Mars Compass
 - FUV/MUV Spectrograph – IUVS MAVEN
 - ARGUS 2000 IR Spectrometer
 - NIR, Visible Doppler Interferometer – MIGHTI
 - P-Band SAR/ Sounder Radar – SMAP 6 m reflector antenna/boom assembly (RBA)
 - Wide Angle Imager – MARCI
 - Thermal IR Limb Radiometer – Mars Climate Sounder
- Assumptions
 - FUV/MUV Spectrograph and Visible Doppler interferometer sizing estimated
 - SMAP SAR hinge locations can be changed
- Options
 - Option 1: Full suite of instruments
 - Option 3: P-Band SAR, LIDAR, Sub-mm Sounder, Wind Interferometer removed

The design configurations are shown as follows:

- Option 1 (stowed), see Figure B-27
- Option 1 (stowed, in fairing), see Figure B-28
- Option 1 (deployed), see Figure B-29
- Option 1 (deployed), see Figure B-30
- Option 1 (boom deployment), see Figure B-31
- Option 3 (stowed), see Figure B-32
- Option 3 (stowed, in fairing), see Figure B-33
- Option 3 (deployed), see Figure B-34
- Option 3 (deployed), see Figure B-35

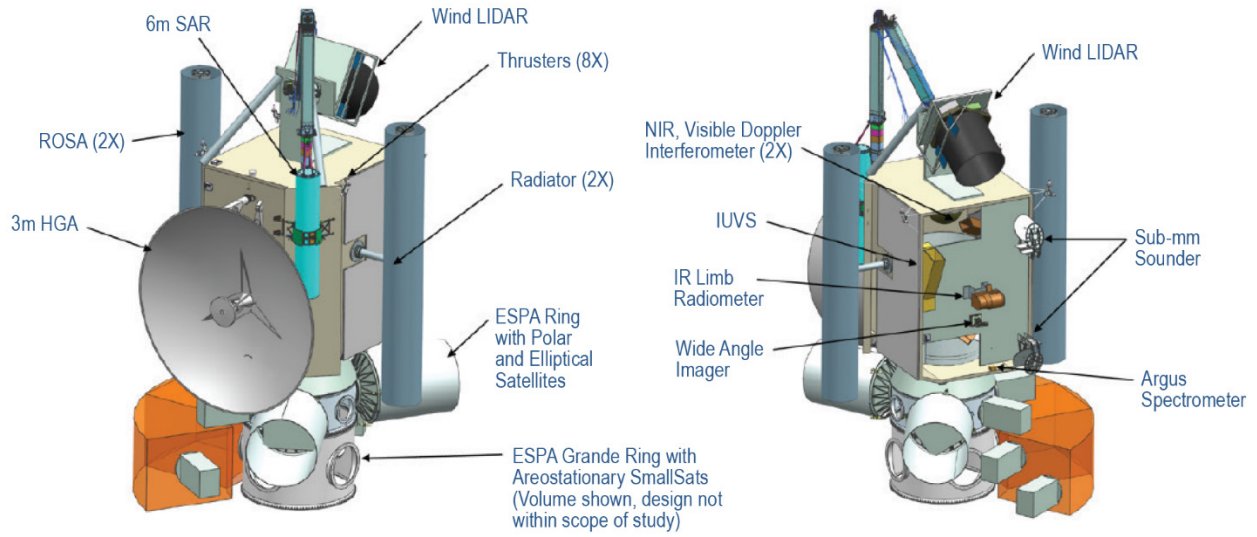

Figure B-27. Option 1 (stowed).

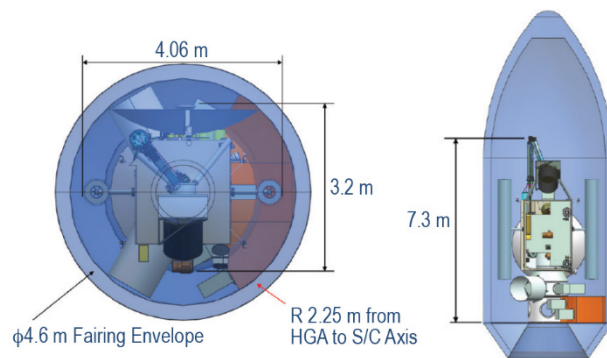

Figure B-28. Option 1 (stowed, in fairing).

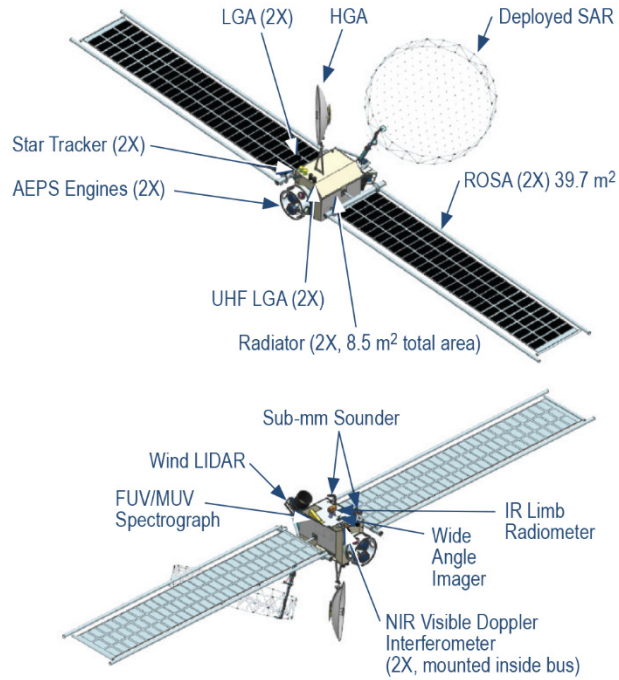

Figure B-29. Option 1 (deployed).

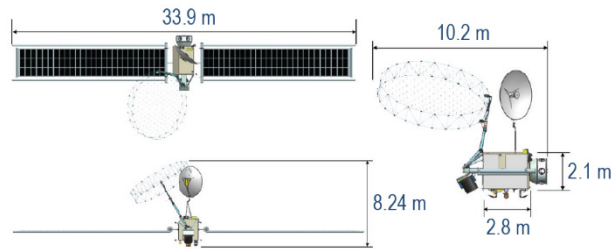

Figure B-30. Option 1 (deployed).

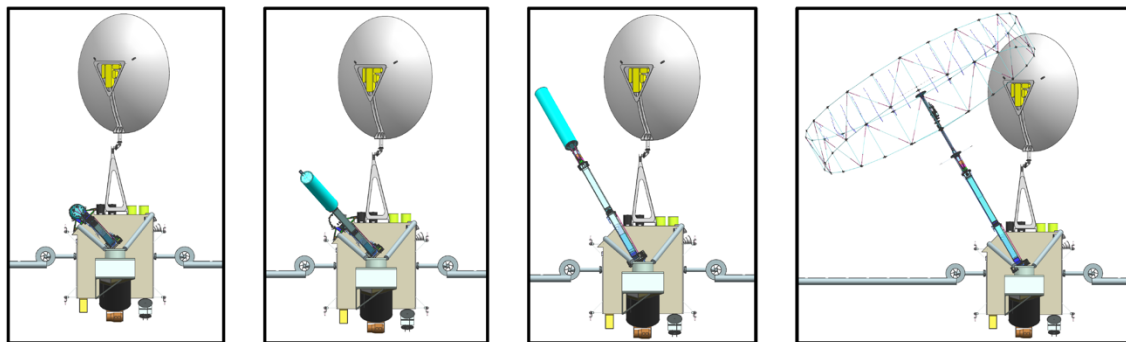

Figure B-31. Option 1 (boom deployment).

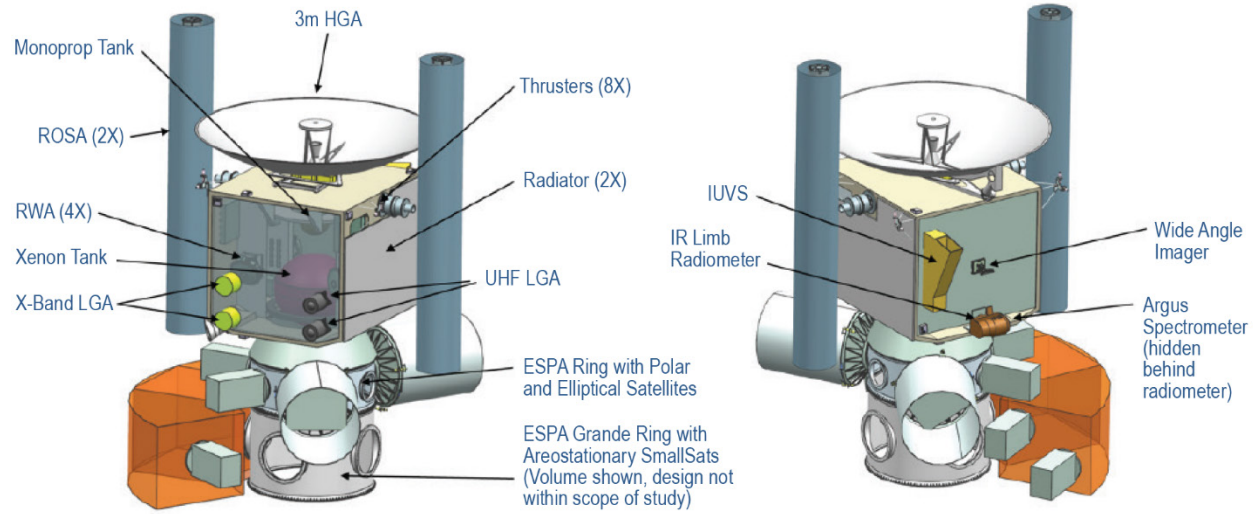

Figure B-32. Option 3 (stowed).

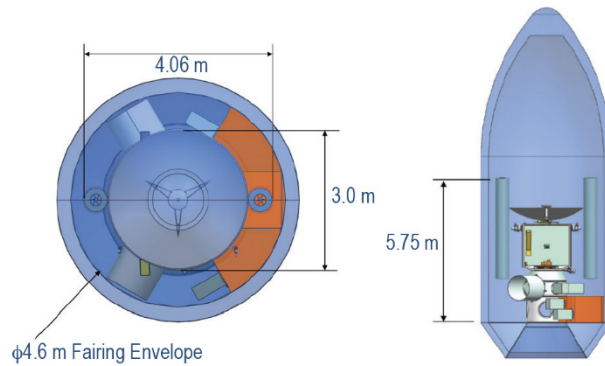

Figure B-33. Option 3 (stowed, in fairing).

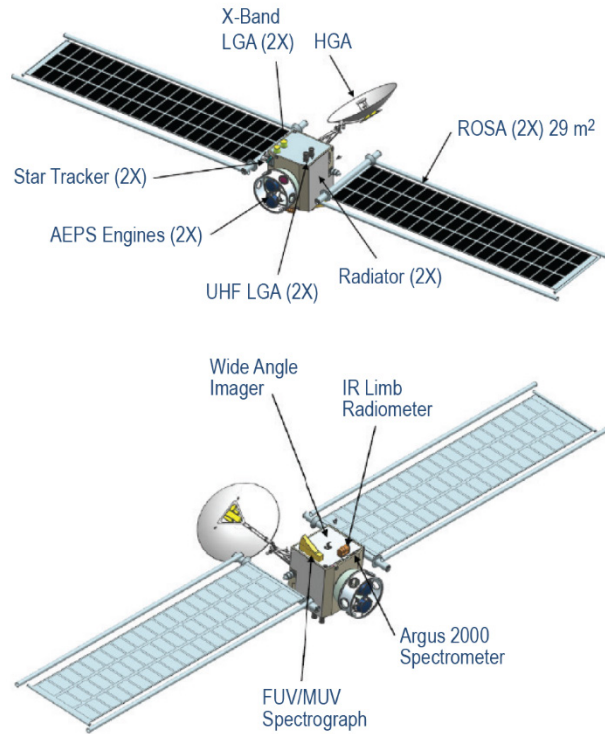

Figure B-34. Option 3 (deployed).

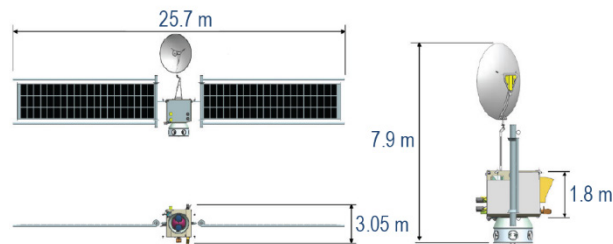

Figure B-35. Option 3 (deployed).

Configuration design rationale

- Configuration is driven by instrument lines of sight
 - Several nadir pointing instruments
 - Gimbaled instruments
- Trade Studies
 - Possible study: (not completed)
 - Option 1: Swap Nadir deck instrument locations with MARLI to help making structure to support SAR boom

A configuration option comparison is shown in Table B-44.

Table 44. Configuration option comparison.

Option	LV	Configuration
1	F9H	<ul style="list-style-type: none"> • 1.1 m diameter Xe prop tank • 0.56 m Monoprop tank • 2X 39.7 m² solar array • P-Band Sounder Radar Reflector • Wide Angle Imager (MARCI) • IR Limb Radiometer • Wind Lidar (MARLI) • Sub-mm Sounder (Mars Compass) • Argus 2000 IR Spectrometer • Wind Doppler Interferometer (MIGHTI) • FUV/MUV Spectrograph (IUVS) • 2.8 m tall bus • 8.5 m² Radiator Area
2	F9H	<ul style="list-style-type: none"> • 0.99 m diameter Xe Prop Tank • 0.39 m Monoprop tank • 2X 29 m² solar array • Visible Imager • Limb Radiometer • Argus 2000 IR Spectrometer • FUV/MUV Spectrometer (IUVS) • 1.8 m tall bus • 6.1 m² Radiator Area

Additional comments on configuration

- Thruster locations and support structure need to be repositioned due to plume impingement on HGA and SAR
- SAR boom could be redesigned to reduce footprint on spacecraft
- ESPA ring to be customized to fit large secondary spacecraft
- Location of payload hardware may need to be optimized to fulfill stress and spin balance requirements
- Secondary support structure, cabling, thermal protection and prop line routing not shown but need to be accommodated
- Solar panel sizing may need to be optimized or changed for procurement from supplier

B.4.7 Mechanical

Design assumptions

- The Power subsystem is carrying the arrays and array support structure. The mechanical subsystem will carry the actuator and launch locks.
- The MOSAIC study team supplied design is the baseline. Modifications are made to meet the requirements.

Mechanical Design

- Design
 - Spacecraft Bus: Rectangular Bus

- Power Source: Two Roll Out Solar Arrays
- Telecom: 3-m HGA on a deployable boom
- Payload Support Structure: All payloads are mounted directly to the Bus. Some instruments have articulation on their own.
- Other Items:
 - ESPA Ring is 1666 mm diameter so spacecraft will interface with the 1666 mm interface. The LVA will act as the link between the Mothership and the ESPA Ring.
- Mechanisms & Deployments
 - Power Deployments: Each Roll Out Solar Array deploys and articulates on a 1-axis gimbal.
 - Telecom Deployments: The HGA is on a single deployable boom and articulates on a 2-axis gimbal.
 - Launch Vehicle Separation: Marmon clamp to ESPA Ring and Lightbands for the smaller components on the ESPA Ring.

Mechanical design rationale

- Bus shape was selected based on MOSAIC study team design. There was not a strong reason to change it so it was left at rectangular.
- Ultraflex arrays were baseline and they were changed to the Roll Out Solar Arrays.
- All instruments were located based on the field of view requirements. No additional articulation was needed.

Mechanical design option 1

The detailed mass list is shown in Table B-45.

- Mass Drivers
 - The primary structure is the largest mass driver. The next largest mass is the balance mass.
- Potential Mass Savings
 - The best place for mass savings is the balance mass. It is high based on the algorithm but careful placement of the components can reduce this mass.
- Potential Mass Uppers
 - The uncertainty of the power and telecom support structure (booms, launch locks, actuators, etc.) could see the reported mass increase.

Table B-45. Mechanical design, option1.

Item	Type	Quantity	CBE	Contingency	CBE + Cont.
Primary Structure	Structure	1	292.9 kg	30%	380.8 kg
Secondary Structure	Structure	1	23.1 kg	30%	30.1 kg
Tertiary Structure	Structure	1	5.9 kg	30%	7.7 kg
Power Support Structure	Structure	1	4.8 kg	30%	6.2 kg
Power Mechanisms	Mechanism		7.6 kg	30%	9.9 kg
Telecom Support Structure	Structure	1	5.8 kg	30%	7.6 kg
Telecom Mechanisms	Mechanism		10.8 kg	30%	14.0 kg
Launch Vehicle Adapter–Structure	Structure	1	45.5 kg	30%	59.1 kg
Launch Vehicle Adapter–Mechanism	Mechanism		18.0 kg	30%	23.4 kg
Balance/Ballast	Structure	1	79.2 kg	30%	103.0 kg
Integration Hardware	Structure	1	22.5 kg	30%	29.3 kg
Harness	Cabling–Manufacturing	1	81.6 kg	30%	106.1 kg
Mechanical Total			516.2 kg	30%	671.0 kg
Harness Total			81.6 kg	30%	106.1 kg

Mechanical design option 3

The detailed mass list is shown in Table B-46.

- Mass Drivers
 - The primary structure is the largest mass driver. The next largest mass is the balance mass.
- Potential Mass Savings
 - The best place for mass savings is the balance mass. It is high based on the algorithm but careful placement of the components can reduce this mass.
- Potential Mass Uppers
 - The uncertainty of the power and telecom support structure (booms, launch locks, actuators, etc.) could see the reported mass increase.

Table B-46. Mechanical design option 3.

Item	Type	Quantity	CBE	Contingency	CBE + Cont.
Primary Structure	Structure	1	198.5 kg	30%	258.0 kg
Secondary Structure	Structure	1	15.1 kg	30%	19.7 kg
Tertiary Structure	Structure	1	4.4 kg	30%	5.7 kg
Power Support Structure	Structure	1	3.5 kg	30%	4.5 kg
Power Mechanisms	Mechanism		7.6 kg	30%	9.9 kg
Telecom Support Structure	Structure	1	2.3 kg	30%	2.9 kg
Telecom Mechanisms	Mechanism		7.2 kg	30%	9.4 kg
Launch Vehicle Adapter–Structure	Structure	1	29.9 kg	30%	38.9 kg
Launch Vehicle Adapter–Mechanism	Mechanism		18.0 kg	30%	23.4 kg
Balance/Ballast	Structure	1	58.3 kg	30%	75.8 kg
Integration Hardware	Structure	1	15.3 kg	30%	19.8 kg
Harness	Cabling–Manufacturing	1	57.2 kg	30%	74.4 kg
Sub-mm Sounder			360.0 kg	30%	468.0 kg
Harness Total			57.2 kg	30%	74.4 kg

Mechanical cost assumptions

- At the spacecraft level:
 - 1 Flight Unit; 1 EM; 1 STM
 - The EM is for testing mechanisms
 - The STM (Structural Test Model) is for testing structure
- Costs for the non-Mothership components is provided by the MOSAIC study team.
- Mechanical Systems, Analysis and Dynamics costs are for the entire mission and not just the Mothership. These costs are mission based and are not broken down per component.

The hardware element cost table for option 1 is shown in Table B-47. The WBS breakdown cost table for option 1 is provided in Table B-48. Option 1 can be summarized as:

- Cost Drivers
 - The largest cost driver is the primary structure followed by the loads/analysis cost.
- Potential Cost Savings
 - The mechanical systems, analysis and dynamics costs are mission based and could be lower. This depends on the other elements.
- Potential Cost Uppers
 - Large system level testing is not included. There are not any out of the ordinary test. If there is one, it would be a cost upper.

Table B-47. Hardware element cost table for option 1.

Item	Type	Quantity	Base Cost	Spare Cost	Eng & Des	Dev Test	Hardware	Qual Test	NRE	RE	Labor	Procurement	Services	Total Cost
Primary Structure	Structure	1	\$15.57 M	\$0.00 M	\$6.31 M	\$4.28 M	\$4.21 M	\$0.78 M	\$12.29 M	\$5.17 M	\$3.84 M	\$9.43 M	\$4.19 M	\$17.46 M
Secondary Structure	Structure	1	\$2.02 M	\$0.00 M	\$0.82 M	\$0.56 M	\$0.55 M	\$0.10 M	\$1.60 M	\$0.67 M	\$0.50 M	\$1.23 M	\$0.55 M	\$2.27 M
Tertiary Structure	Structure	1	\$0.11 M	\$0.00 M	\$0.04 M	\$0.03 M	\$0.03 M	\$0.01 M	\$0.08 M	\$0.04 M	\$0.03 M	\$0.07 M	\$0.03 M	\$0.12 M
Power Support Structure	Structure	1	\$0.41 M	\$0.00 M	\$0.17 M	\$0.11 M	\$0.11 M	\$0.02 M	\$0.32 M	\$0.14 M	\$0.10 M	\$0.25 M	\$0.11 M	\$0.46 M
Power Mechanisms	Mechanism	1	\$4.06 M	\$0.00 M	\$1.65 M	\$1.12 M	\$1.10 M	\$0.20 M	\$3.21 M	\$1.35 M	\$1.09 M	\$2.55 M	\$0.91 M	\$4.56 M
Telecom Support Structure	Structure	1	\$2.55 M	\$0.00 M	\$1.03 M	\$0.70 M	\$0.69 M	\$0.13 M	\$2.01 M	\$0.85 M	\$0.63 M	\$1.54 M	\$0.69 M	\$2.86 M
Telecom Mechanisms	Mechanism	1	\$6.68 M	\$0.00 M	\$2.71 M	\$1.83 M	\$1.80 M	\$0.33 M	\$5.28 M	\$2.22 M	\$1.80 M	\$4.20 M	\$1.50 M	\$7.49 M
Launch Vehicle Adapter - Struc	Structure	1	\$0.41 M	\$0.00 M	\$0.17 M	\$0.11 M	\$0.11 M	\$0.02 M	\$0.33 M	\$0.14 M	\$0.10 M	\$0.25 M	\$0.11 M	\$0.46 M
Launch Vehicle Adapter - Mech	Mechanism	1	\$0.41 M	\$0.00 M	\$0.17 M	\$0.11 M	\$0.11 M	\$0.02 M	\$0.33 M	\$0.14 M	\$0.10 M	\$0.26 M	\$0.09 M	\$0.46 M
Balance/Ballast	Structure	1	\$0.28 M	\$0.00 M	\$0.11 M	\$0.08 M	\$0.07 M	\$0.01 M	\$0.22 M	\$0.09 M	\$0.07 M	\$0.17 M	\$0.07 M	\$0.31 M
Integration Hardware	Structure	1	\$0.28 M	\$0.00 M	\$0.11 M	\$0.08 M	\$0.07 M	\$0.01 M	\$0.22 M	\$0.09 M	\$0.07 M	\$0.17 M	\$0.07 M	\$0.31 M
Cabling: Management (PEM)	Cabling-Eng	1	\$2.47 M	\$0.00 M	\$1.73 M	\$0.25 M	\$0.25 M	\$0.25 M	\$2.27 M	\$0.52 M	\$1.62 M	\$0.42 M	\$0.76 M	\$2.80 M
Cabling: Engineering	Cabling-Eng	1	\$4.35 M	\$0.00 M	\$3.05 M	\$0.44 M	\$0.44 M	\$0.44 M	\$4.00 M	\$0.92 M	\$2.86 M	\$0.74 M	\$1.33 M	\$4.93 M
Cabling: Design	Cabling-Eng	1	\$0.99 M	\$0.00 M	\$0.70 M	\$0.10 M	\$0.10 M	\$0.10 M	\$0.91 M	\$0.21 M	\$0.65 M	\$0.17 M	\$0.30 M	\$1.12 M
Cabling: Parts	Cabling-Mfg	1	\$2.63 M	\$0.00 M	\$0.39 M	\$0.39 M	\$1.45 M	\$0.39 M	\$1.21 M	\$1.67 M	\$0.23 M	\$1.01 M	\$1.64 M	\$2.88 M
Cabling: Fab & Assy	Cabling-Mfg	1	\$8.76 M	\$0.00 M	\$1.31 M	\$1.31 M	\$4.82 M	\$1.31 M	\$4.03 M	\$5.57 M	\$0.77 M	\$3.36 M	\$5.47 M	\$9.60 M
Cabling: I&T	Cabling-Mfg	1	\$6.13 M	\$0.00 M	\$0.92 M	\$0.92 M	\$3.37 M	\$0.92 M	\$2.82 M	\$3.90 M	\$0.54 M	\$2.35 M	\$3.83 M	\$6.72 M
MSE: Mechanical PEM	Mech Sys-Labor	1	\$4.44 M	\$0.00 M	\$3.55 M	\$0.44 M	\$0.00 M	\$0.44 M	\$4.09 M	\$0.94 M	\$3.57 M	\$0.65 M	\$0.80 M	\$5.03 M
MSE: Administration	Mech Sys-Labor	1	\$2.73 M	\$0.00 M	\$2.19 M	\$0.27 M	\$0.00 M	\$0.27 M	\$2.52 M	\$0.58 M	\$2.20 M	\$0.40 M	\$0.50 M	\$3.10 M
MSE: Mech Chief Engineer	Mech Sys-Labor	1	\$5.31 M	\$0.00 M	\$4.25 M	\$0.53 M	\$0.00 M	\$0.53 M	\$4.88 M	\$1.13 M	\$4.27 M	\$0.78 M	\$0.96 M	\$6.01 M
MSE: Lead Designer	Mech Sys-Labor	1	\$3.07 M	\$0.00 M	\$2.46 M	\$0.31 M	\$0.00 M	\$0.31 M	\$2.83 M	\$0.65 M	\$2.47 M	\$0.45 M	\$0.56 M	\$3.48 M
MSE: Mass Properties Engineer	Mech Sys-Labor	1	\$2.48 M	\$0.00 M	\$1.98 M	\$0.25 M	\$0.00 M	\$0.25 M	\$2.28 M	\$0.53 M	\$1.99 M	\$0.37 M	\$0.45 M	\$2.81 M
MSE: Mech Systems Engineer	Mech Sys-Labor	1	\$7.14 M	\$0.00 M	\$5.71 M	\$0.71 M	\$0.00 M	\$0.71 M	\$6.57 M	\$1.51 M	\$5.74 M	\$1.05 M	\$1.29 M	\$8.08 M
Mechanical I&T	Structure	1	\$2.87 M	\$0.00 M	\$1.16 M	\$0.79 M	\$0.77 M	\$0.14 M	\$2.26 M	\$0.95 M	\$0.71 M	\$1.74 M	\$0.77 M	\$3.22 M
Mechanical GSE	Structure	1	\$3.33 M	\$0.00 M	\$1.35 M	\$0.92 M	\$0.90 M	\$0.17 M	\$2.63 M	\$1.11 M	\$0.82 M	\$2.02 M	\$0.90 M	\$3.74 M
Loads and Analysis	Lds & Dyn	1	\$10.61 M	\$0.00 M	\$9.02 M	\$1.06 M	\$0.00 M	\$0.53 M	\$12.20 M	\$0.00 M	\$12.20 M	\$0.00 M	\$0.00 M	\$12.20 M
Dynamic Environments	Lds & Dyn	1	\$6.37 M	\$0.00 M	\$5.41 M	\$0.64 M	\$0.00 M	\$0.32 M	\$7.32 M	\$0.00 M	\$7.32 M	\$0.00 M	\$0.00 M	\$7.32 M
Materials & Processes	Mat & Proc	1	\$10.36 M	\$0.00 M	\$6.21 M	\$2.07 M	\$0.00 M	\$2.07 M	\$9.32 M	\$1.04 M	\$9.78 M	\$0.58 M	\$0.00 M	\$10.36 M
Contamination Control	Cont Cntl	1	\$4.41 M	\$0.00 M	\$4.41 M	\$0.00 M	\$0.00 M	\$0.00 M	\$4.05 M	\$0.93 M	\$4.60 M	\$0.19 M	\$0.20 M	\$4.99 M
06.07 - Mechanical Subsystem			\$81.4 M	\$0.0 M	\$50.37 M	\$14.92 M	\$10.53 M	\$5.32 M	\$73.47 M	\$18.29 M	\$49.63 M	\$27.57 M	\$14.55 M	\$91.76 M
06.11 - Harness			\$25.34 M	\$0.0 M	\$8.10 M	\$3.41 M	\$10.42 M	\$3.41 M	\$15.25 M	\$12.80 M	\$6.67 M	\$8.05 M	\$13.34 M	\$28.06 M
06.13 - Materials & Processes			\$10.36 M	\$0.0 M	\$6.21 M	\$2.07 M	\$0.00 M	\$2.07 M	\$9.32 M	\$1.04 M	\$9.78 M	\$0.58 M	\$0.00 M	\$10.36 M
02.07 - Contamination Control			\$4.41 M	\$0.0 M	\$4.41 M	\$0.00 M	\$0.00 M	\$0.00 M	\$4.05 M	\$0.93 M	\$4.60 M	\$0.19 M	\$0.20 M	\$4.99 M

Table B-48. WBS breakdown cost for option 1.

WBS Title	NRE	RE	Labor	Procurement	Services	Total Cost
06.07—Mechanical Subsystem	\$73.47M	\$18.29M	\$49.63M	\$27.57M	\$14.55M	\$91.76M
06.07.01—Mechanical Subsystem Management	\$11.49M	\$2.65M	\$10.03M	\$1.84M	\$2.26M	\$14.13M
06.07.02—Mechanical Subsystem Engineering	\$6.57M	\$1.51M	\$5.74M	\$1.05M	\$1.29M	\$8.08M
06.07.03—Loads & Dynamics Analysis	\$19.52M	\$0.00M	\$19.52M	\$0.00M	\$0.00M	\$19.52M
06.07.04—Configuration & Mass Properties	\$5.11M	\$1.18M	\$4.46M	\$0.82M	\$1.01M	\$6.29M
06.07.05—Structural Hardware	\$17.07M	\$7.18M	\$5.34M	\$13.10M	\$5.82M	\$24.25M
06.07.06—Mechanisms	\$8.81M	\$3.71M	\$3.00M	\$7.01M	\$2.50M	\$12.52M
06.07.07—Mechanical Subsystem EGSE	\$0.00M	\$0.00M	\$0.00M	\$0.00M	\$0.00M	\$0.00M
06.07.08—Mechanical Subsystem MGSE	\$2.63M	\$1.11M	\$0.82M	\$2.02M	\$0.90M	\$3.74M
06.07.09—Mechanical Subsystem I&T	\$2.26M	\$0.95M	\$0.71M	\$1.74M	\$0.77M	\$3.22M
06.11—Harness	\$15.25M	\$12.80M	\$6.67M	\$8.05M	\$13.34M	\$28.06M
06.11.01—Harness Management	\$2.27M	\$0.52M	\$1.62M	\$0.42M	\$0.76M	\$2.80M
06.11.02—Harness Engineering	\$4.00M	\$0.92M	\$2.86M	\$0.74M	\$1.33M	\$4.93M
06.11.03—Harness Design	\$0.91M	\$0.21M	\$0.65M	\$0.17M	\$0.30M	\$1.12M
06.11.04—Harness Parts	\$1.21M	\$1.67M	\$0.23M	\$1.01M	\$1.64M	\$2.88M
06.11.05—Harness Fab & Assy	\$4.03M	\$5.57M	\$0.77M	\$3.36M	\$5.47M	\$9.60M
06.11.06—Harness I&T	\$2.82M	\$3.90M	\$0.54M	\$2.35M	\$3.83M	\$6.72M
06.13—Materials & Processes	\$9.32M	\$1.04M	\$9.78M	\$0.58M	\$0.00M	\$10.36M
02.07—Contamination Control	\$4.05M	\$0.93M	\$4.60M	\$0.19M	\$0.20M	\$4.99M

The hardware element cost table for option 3 is shown in Table B-49. The WBS breakdown cost table for option 3 is provided in Table B-50. Option 3 can be summarized as:

- Cost Drivers
 - The largest cost driver is the primary structure followed by the power mechanisms cost.
- Potential Cost Savings

- The mechanical systems, analysis and dynamics costs are mission based and could be lower. This depends on the other elements.
- Potential Cost Uppers
 - Large system level testing is not included. There are not any out of the ordinary test. If there is one, it would be a cost upper.

Table B-49. Hardware element cost table for option 3.

Item	Type	Quantity	Base Cost	Spare Cost	Eng & Des	Dev Test	Hardware	Qual Test	NRE	RE	Labor	Procurement	Services	Total Cost
Primary Structure	Structure	1	\$11.82 M	\$0.00 M	\$4.79 M	\$3.25 M	\$3.19 M	\$0.59 M	\$8.52 M	\$3.78 M	\$2.71 M	\$6.64 M	\$2.95 M	\$12.30 M
Secondary Structure	Structure	1	\$2.01 M	\$0.00 M	\$0.81 M	\$0.55 M	\$0.54 M	\$0.10 M	\$1.45 M	\$0.64 M	\$0.46 M	\$1.13 M	\$0.50 M	\$2.09 M
Tertiary Structure	Structure	1	\$0.11 M	\$0.00 M	\$0.04 M	\$0.03 M	\$0.03 M	\$0.01 M	\$0.08 M	\$0.03 M	\$0.02 M	\$0.06 M	\$0.03 M	\$0.11 M
Power Support Structure	Structure	1	\$0.30 M	\$0.00 M	\$0.12 M	\$0.08 M	\$0.08 M	\$0.01 M	\$0.22 M	\$0.10 M	\$0.07 M	\$0.17 M	\$0.07 M	\$0.31 M
Power Mechanisms	Mechanism	1	\$4.06 M	\$0.00 M	\$1.65 M	\$1.12 M	\$1.10 M	\$0.20 M	\$2.93 M	\$1.30 M	\$1.01 M	\$2.37 M	\$0.85 M	\$4.23 M
Telecom Support Structure	Structure	1	\$1.52 M	\$0.00 M	\$0.61 M	\$0.42 M	\$0.41 M	\$0.08 M	\$1.09 M	\$0.48 M	\$0.35 M	\$0.85 M	\$0.38 M	\$1.58 M
Telecom Mechanisms	Mechanism	1	\$4.22 M	\$0.00 M	\$1.71 M	\$1.16 M	\$1.14 M	\$0.21 M	\$3.04 M	\$1.35 M	\$1.05 M	\$2.46 M	\$0.88 M	\$4.39 M
Launch Vehicle Adapter - Struc	Structure	1	\$0.41 M	\$0.00 M	\$0.17 M	\$0.11 M	\$0.11 M	\$0.02 M	\$0.30 M	\$0.13 M	\$0.09 M	\$0.23 M	\$0.10 M	\$0.43 M
Launch Vehicle Adapter - Mech	Mechanism	1	\$0.41 M	\$0.00 M	\$0.17 M	\$0.11 M	\$0.11 M	\$0.02 M	\$0.30 M	\$0.13 M	\$0.10 M	\$0.24 M	\$0.09 M	\$0.43 M
Balance/Ballast	Structure	1	\$0.14 M	\$0.00 M	\$0.06 M	\$0.04 M	\$0.04 M	\$0.01 M	\$0.10 M	\$0.04 M	\$0.03 M	\$0.08 M	\$0.03 M	\$0.14 M
Integration Hardware	Structure	1	\$0.14 M	\$0.00 M	\$0.06 M	\$0.04 M	\$0.04 M	\$0.01 M	\$0.10 M	\$0.04 M	\$0.03 M	\$0.08 M	\$0.03 M	\$0.14 M
Cabling: Management (PEM)	Cabling-Eng	1	\$0.67 M	\$0.00 M	\$0.47 M	\$0.07 M	\$0.07 M	\$0.07 M	\$0.56 M	\$0.14 M	\$0.40 M	\$0.10 M	\$0.19 M	\$0.70 M
Cabling: Engineering	Cabling-Eng	1	\$1.16 M	\$0.00 M	\$0.81 M	\$0.12 M	\$0.12 M	\$0.12 M	\$0.97 M	\$0.24 M	\$0.70 M	\$0.18 M	\$0.33 M	\$1.21 M
Cabling: Design	Cabling-Eng	1	\$0.26 M	\$0.00 M	\$0.18 M	\$0.03 M	\$0.03 M	\$0.03 M	\$0.22 M	\$0.05 M	\$0.16 M	\$0.04 M	\$0.07 M	\$0.27 M
Cabling: Parts	Cabling-Mfg	1	\$1.01 M	\$0.00 M	\$0.15 M	\$0.15 M	\$0.56 M	\$0.15 M	\$0.42 M	\$0.62 M	\$0.08 M	\$0.36 M	\$0.59 M	\$1.04 M
Cabling: Fab & Assy	Cabling-Mfg	1	\$3.36 M	\$0.00 M	\$0.50 M	\$0.50 M	\$0.50 M	\$1.85 M	\$1.41 M	\$2.06 M	\$0.28 M	\$1.22 M	\$1.98 M	\$3.47 M
Cabling: I&T	Cabling-Mfg	1	\$2.36 M	\$0.00 M	\$0.35 M	\$0.35 M	\$1.30 M	\$0.35 M	\$0.99 M	\$1.44 M	\$0.19 M	\$0.85 M	\$1.39 M	\$2.43 M
MSE: Mechanical PEM	Mech Sys-Labor	1	\$2.94 M	\$0.00 M	\$2.35 M	\$0.29 M	\$0.29 M	\$0.29 M	\$2.47 M	\$0.60 M	\$2.18 M	\$0.40 M	\$0.49 M	\$3.07 M
MSE: Administration	Mech Sys-Labor	1	\$1.81 M	\$0.00 M	\$1.45 M	\$0.18 M	\$0.00 M	\$0.18 M	\$1.52 M	\$0.37 M	\$1.34 M	\$0.25 M	\$0.30 M	\$1.89 M
MSE: Mech Chief Engineer	Mech Sys-Labor	1	\$3.48 M	\$0.00 M	\$2.79 M	\$0.35 M	\$0.35 M	\$0.35 M	\$2.93 M	\$0.71 M	\$2.58 M	\$0.47 M	\$0.58 M	\$3.64 M
MSE: Lead Designer	Mech Sys-Labor	1	\$1.97 M	\$0.00 M	\$1.57 M	\$0.20 M	\$0.00 M	\$0.20 M	\$1.65 M	\$0.40 M	\$1.46 M	\$0.27 M	\$0.33 M	\$2.05 M
MSE: Mass Properties Engineer	Mech Sys-Labor	1	\$1.61 M	\$0.00 M	\$1.29 M	\$0.16 M	\$0.00 M	\$0.16 M	\$1.35 M	\$0.33 M	\$1.19 M	\$0.22 M	\$0.27 M	\$1.68 M
MSE: Mech Systems Engineer	Mech Sys-Labor	1	\$4.73 M	\$0.00 M	\$3.78 M	\$0.47 M	\$0.00 M	\$0.47 M	\$3.97 M	\$0.97 M	\$3.51 M	\$0.64 M	\$0.79 M	\$4.94 M
Mechanical I&T	Structure	1	\$2.20 M	\$0.00 M	\$0.89 M	\$0.60 M	\$0.60 M	\$0.11 M	\$1.59 M	\$0.70 M	\$0.50 M	\$1.24 M	\$0.55 M	\$2.29 M
Mechanical GSE	Structure	1	\$2.56 M	\$0.00 M	\$1.04 M	\$0.70 M	\$0.69 M	\$0.13 M	\$1.84 M	\$0.82 M	\$0.59 M	\$1.44 M	\$0.64 M	\$2.66 M
Loads and Analysis	Lds & Dyn	1	\$3.98 M	\$0.00 M	\$3.38 M	\$0.40 M	\$0.00 M	\$0.20 M	\$4.18 M	\$0.00 M	\$4.18 M	\$0.00 M	\$0.00 M	\$4.18 M
Dynamic Environments	Lds & Dyn	1	\$2.39 M	\$0.00 M	\$2.03 M	\$0.24 M	\$0.00 M	\$0.12 M	\$2.51 M	\$0.00 M	\$2.51 M	\$0.00 M	\$0.00 M	\$2.51 M
Materials & Processes	Mat & Proc	1	\$4.19 M	\$0.00 M	\$2.52 M	\$0.84 M	\$0.00 M	\$0.84 M	\$3.77 M	\$0.42 M	\$4.08 M	\$0.12 M	\$0.00 M	\$4.19 M
Contamination Control	Cont Cntl	1	\$3.05 M	\$0.00 M	\$3.05 M	\$0.00 M	\$0.00 M	\$0.00 M	\$2.57 M	\$0.62 M	\$2.83 M	\$0.17 M	\$0.18 M	\$3.19 M
06.07 - Mechanical Subsystem			\$52.80 M	\$0.00 M	\$30.76 M	\$10.50 M	\$8.07 M	\$3.47 M	\$42.13 M	\$12.93 M	\$25.97 M	\$19.22 M	\$9.87 M	\$55.06 M
06.11 - Harness			\$8.82 M	\$0.00 M	\$2.47 M	\$1.22 M	\$3.91 M	\$1.22 M	\$4.58 M	\$4.54 M	\$1.82 M	\$2.76 M	\$4.55 M	\$9.12 M
06.13 - Materials & Processes			\$4.19 M	\$0.00 M	\$2.52 M	\$0.84 M	\$0.00 M	\$0.84 M	\$3.77 M	\$0.42 M	\$4.08 M	\$0.12 M	\$0.00 M	\$4.19 M
02.07 - Contamination Control			\$3.05 M	\$0.00 M	\$3.05 M	\$0.00 M	\$0.00 M	\$0.00 M	\$2.57 M	\$0.62 M	\$2.83 M	\$0.17 M	\$0.18 M	\$3.19 M

Table B-50. WBS breakdown cost for option 3.

WBS Title	NRE	RE	Labor	Procurement	Services	Total Cost
06.07-Mechanical Subsystem	\$42.13M	\$12.93M	\$25.97M	\$19.22M	\$9.87M	\$55.06M
06.07.01-Mechanical Subsystem Management	\$6.92M	\$1.68M	\$6.10M	\$1.12M	\$1.38M	\$8.60M
06.07.02-Mechanical Subsystem Engineering	\$3.97M	\$0.97M	\$3.51M	\$0.64M	\$0.79M	\$4.94M
06.07.03-Loads & Dynamics Analysis	\$6.69M	\$0.00M	\$6.69M	\$0.00M	\$0.00M	\$6.69M
06.07.04-Configuration & Mass Properties	\$3.00M	\$0.73M	\$2.65M	\$0.49M	\$0.60M	\$3.73M
06.07.05-Structural Hardware	\$11.85M	\$5.25M	\$3.76M	\$9.24M	\$4.11M	\$17.10M
06.07.06-Mechanisms	\$6.27M	\$2.78M	\$2.17M	\$5.07M	\$1.81M	\$9.04M
06.07.07-Mechanical Subsystem EGSE	\$0.00M	\$0.00M	\$0.00M	\$0.00M	\$0.00M	\$0.00M
06.07.08-Mechanical Subsystem MGSE	\$1.84M	\$0.82M	\$0.59M	\$1.44M	\$0.64M	\$2.66M
06.07.09-Mechanical Subsystem I&T	\$1.59M	\$0.70M	\$0.50M	\$1.24M	\$0.55M	\$2.29M
06.11-Harness	\$4.58M	\$4.54M	\$1.82M	\$2.76M	\$4.55M	\$9.12M
06.11.01-Harness Management	\$0.56M	\$0.14M	\$0.40M	\$0.10M	\$0.19M	\$0.70M
06.11.02-Harness Engineering	\$0.97M	\$0.24M	\$0.70M	\$0.18M	\$0.33M	\$1.21M
06.11.03-Harness Design	\$0.22M	\$0.05M	\$0.16M	\$0.04M	\$0.07M	\$0.27M
06.11.04-Harness Parts	\$0.42M	\$0.62M	\$0.08M	\$0.36M	\$0.59M	\$1.04M
06.11.05-Harness Fab & Assy	\$1.41M	\$2.06M	\$0.28M	\$1.22M	\$1.98M	\$3.47M
06.11.06-Harness I&T	\$0.99M	\$1.44M	\$0.19M	\$0.85M	\$1.39M	\$2.43M
06.13-Materials & Processes	\$3.77M	\$0.42M	\$4.08M	\$0.12M	\$0.00M	\$4.19M
02.07-Contamination Control	\$2.57M	\$0.62M	\$2.83M	\$0.17M	\$0.18M	\$3.19M

The mechanical option comparison can be seen in Table B-51. CBE masses are removed.

Table B-51. Mechanical option comparison.

Option	Mechanical (06.07) Mass	Mechanical (06.07) Cost	Configuration	Comments
1	516.2 kg	\$91.76 M	All Instruments Installed	
3	360.0 kg	\$55.06 M	SAR, LIDAR, Sub-mm Sounder, MIGHTI Instruments removed.	

B.4.8 ACS

Design assumptions

- Option 1
 - Wet mass 5175 kg at start of interplanetary cruise, 4397 kg at Mars arrival (C3=0), 3922 in low Mars orbit, 3035 kg orbiter dry mass
 - Prop/wheel requirements analysis in cruise assumes 4397 kg
 - Prop/wheel requirements analysis in orbit assumes 3922 kg
 - In orbit: S/C points to nadir 90% of each orbit (points 30 deg off-nadir (“rolled” about the ram direction) 10% of each orbit (11.3 min)
 - SAR antenna mounted so that it points to nadir when S/C points 30 deg off-nadir
- Option 2 (ACS not involved in Option 2)
- Option 3
 - No SAR antenna: S/C always points to nadir in orbit
- Option 4 (ACS not involved in Option 4)

ACS architecture

- This study covers the MOSAIC Mothership only, other architectural elements (SmallSats) are covered in separate studies
- Cruise propulsion: SEP
- Stabilization: 3-axis
- Attitude Determination
 - Star tracker measurements augmented by IMU
 - Sun sensor for safe modes/recovery
- Attitude Control
 - Cruise: Attitude control provided by RCS thrusters (perhaps could also be accomplished by SEP thrusters? No analysis of this option however, and RCS thrusters are needed once in Mars orbit anyway)
 - Mars orbit: Attitude control provided by reaction wheels (4 wheels for redundancy) with hydrazine RCS thrusters for momentum unloading
- Slewing
 - Slews on reaction wheels in normal operation
 - RCS thrusters can be used for slews in safe mode if needed
 - Solar panels are on 1-axis gimbals (with cosine losses accepted) and HGA is on 2-axis gimbals, slews in Mars orbit needed for safe mode only.

Maintenance concerns

- Option 1: RCS prop allocation ~50 kg, of which 12 kg is expended on desats in cruise

- Option 3: RCS prop allocation ~15 kg, of which ~11 kg is expended on desats in cruise
 - Assumed wheels are used for attitude control in cruise
 - Assumed that no off-nadir pointing is required in orbit since SAR has been descope, no gravity gradient torque

ACS design rationale on the general architecture

- MOSAIC study team specified SEP
- 3-axis stabilization required for science observations

Cost

- Cost for option 1 is shown in Table B-51.
- Cost for option 3 is shown in Table B-52.
- Cost drivers
 - Mission class (option 1 is class A, option 3 is class B)
- Potential cost savings
 - Might be able to use smaller wheels
 - Might not result in significant overall impact. Savings in power does not shrink solar panels which are mainly driven by SEP, desat prop requirement may slightly rise.

Table B-51. ACS cost for option 1.

All Units Cost			Phase C (Subsystem Design, Fab & I&T)			Phase D		Phase E (Operations & Analysis)		Total (\$K)
	Phase A	Phase B								
06.10 GN&C Subsystem	4833	6425	9249	16897	3698	2073	436	-	-	43611
06.10.01 GN&C Subsystem Management	542	542	506	506	470	687	145			3399
06.10.02 GN&C Subsystem Engineering	1757	1757	1639	1639	1522	1386	292			9992
06.10.03 GN&C Sensors AND		1592	4738	12916						19245
06.10.05 GN&C I/F Electronics										
06.10.08 GN&C Control Analysis	2534	2534	2365	1836	1705				-	10975

Table B-52. ACS cost for option3.

All Units Cost			Phase C (Subsystem Design, Fab & I&T)			Phase D		Phase E (Operations & Analysis)		Total (\$K)
	Phase A	Phase B								
06.10 GN&C Subsystem	3941	4960	7799	13667	1440	1222	349	-	-	33378
06.10.01 GN&C Subsystem Management	347	347	318	174	145	405	116			1851
06.10.02 GN&C Subsystem Engineering	1172	1172	1074	586	488	817	233			5541
06.10.03 GN&C Sensors AND		1019	4186	11939						17144
06.10.05 GN&C I/F Electronics										
06.10.08 GN&C Control Analysis	2422	2422	2220	969	807				-	8841

B.4.9 Power

Design assumptions

- The SEP system requires 100 V to drive the propulsion Power Processing Unit (PPU)
- The rest of the spacecraft operates on standard 32 V power
- The SEP system operates ONLY when the spacecraft is on Sun
- Power Electronics leverages Europa Clipper design

- Mission Design/Navigation engineering performed “Missed Thrust Analysis” which allows power sizing to apply 5% contingency to SEP CBEs

The power summary for option 1 is given in Table B-53, for option 3 is given in Table B-54.

Table B-53. Power summary for option 1.

Subsystem/ Instrument	Mode #	Power (W)							
		1	2	3	4	5	6	7	8
Option 1	Mode Name	Launch	Safe	Thrusting–Earth	Thrusting–Mars	Science–Night–SAR–Eclipse	Science–Night–SAR–Sun	Science–Night–non SAR	Science–Day–Sounder
ACS	W	46	112	112	112	109	109	109	112
C&DH	W	69	69	69	69	69	69	69	69
Instruments	W	0	0	0	0	317	207	207	327
Other Elements	W	0	0	0	0	0	0	0	0
Propulsion System 1	W	0	0	22000	11300	0	0	0	0
Propulsion System 2	W	25	25	33	33	1	1	1	1
Propulsion System 3	W	0	0	0	0	0	0	0	0
Structures	W	0	0	0	0	0	0	0	0
Telecomm	W	28	93	93	93	454	454	454	454
Thermal	W	1457	1326	152	152	967	967	976	963
Power Subsystem	W	234	234	286	211	260	260	251	261
Totals		1860	1860	22746	11971	2177	2177	2067	2186
Systems Contingency	%	43%	43%	43%	43%	43%	43%	43%	43%
Calculated Contingency (Override)	%	43%	43%	6%	7%	43%	43%	43%	43%
Propulsion System 1 (Override)	%	5%	5%	5%	5%	5%	5%	5%	5%
Subsystem Contingency	W	800	800	1421	854	936	936	889	940
Subsystems with Contingency	W	2659	2659	24167	12824	3113	3113	2955	3126
Distribution Losses	W	53	53	483	256	62	62	59	63
Total Subsystems	W	2713	2713	24650	13081	3175	3175	3015	3189
Systems with Contingency	W	2574	2574	25182	13389	3027	302	2870	3041
Duration (published by Systems, hours)		2.0	24.0	24.0	24.0	0.7	0.3	0.8	0.2

Table B-54. Power summary for option 3.

Subsystem/ Instrument	Mode #	Power (W)							
		1	2	3	4	5	6	7	8
Option 3	Mode Name	Launch	Safe	Thrusting– Earth	Thrusting– Mars	Science– Night– SAR– Eclipse	Science– Night– SAR– Sun	Science– Night–non SAR	Science– Day– Sunder
ACS	W	46	112	112	112	109	109	109	112
C&DH	W	63	63	63	63	63	63	63	63
Instruments	W	0	0	0	0	46	46	46	56
Other Elements	W	0	0	0	0	0	0	0	0
Propulsion System 1	W	0	0	14284	7338	0	0	0	0
Propulsion System 2	W	25	25	33	33	1	1	1	1
Propulsion System 3	W	0	0	0	0	0	0	0	0
Structures	W	0	0	0	0	0	0	0	0
Telecomm	W	28	93	93	93	454	454	454	454
Thermal	W	983	852	127	127	515	515	515	510
Power Subsystem	W	192	192	229	181	196	196	196	197
Totals		1338	1338	14943	7948	1384	1384	1384	1393
Systems Contingency	%	43%	43%	43%	43%	43%	43%	43%	43%
Calculated Contingency (Override)	%	43%	43%	7%	8%	43%	43%	43%	43%
Propulsion System 1 (Override)	%	5%	5%	5%	5%	5%	5%	5%	5%
Subsystem Contingency	W	575	575	997	629	595	595	595	599
Subsystems with Contingency	W	1914	1914	15940	8577	1979	1979	1979	1993
Distribution Losses	W	38	38	319	172	40	40	40	40
Total Subsystems	W	1952	1952	16259	8749	2019	2019	2019	2033
Systems with Contingency	W	1872	1872	16610	8953	1938	1938	1938	1951
Duration (published by Systems, hours)		2.0	24.0	24.0	24.0	0.7	0.3	0.8	0.2

Design considerations for the solar arrays (both options)

- Baseline DSS Roll Out Solar Array (ROSA) panels
- ROSA panels are assumed to be able to customize the panel dimensions to conform to launch vehicle constraints
 - Sized for worst case electric propulsion (EP) requirement:
 - High power consumption thrusting approaching Mars’ nearest approach to the Sun at 1.39 AU

The power design for the solar arrays is shown in Table B-55.

Table B-55. Power design for solar arrays.

Solar Array Design Summary			
Mass-Cells, Coverglass, etc.	133.11 Kg		Option 1
Mass-Structure	37.64 Kg		
Mass-Total Array	170.75 Kg		
Total Cell Area	67.35 m ²	33.68 m ²	Wing Cell Area
Total Array Area	79.24 m ²	39.62 m ²	Wing Array Area
# Wings	2	0.85	Packing Factor
Design Technology / Configuration	Roll Out Solar Array (ROSA)		Note: ROSA mass based on Ultraflex mass calcs
Solar Array Design Summary			
Mass-Cells, Coverglass, etc.	89.03 Kg		Option 3
Mass-Structure	25.18 Kg		
Mass-Total Array	114.20 Kg		
Total Cell Area	45.05 m ²	22.52 m ²	Wing Cell Area
Total Array Area	53.00 m ²	26.50 m ²	Wing Array Area
# Wings	2	0.85	Packing Factor
Design Technology / Configuration	Roll Out Solar Array (ROSA)		Note: ROSA mass based on Ultraflex mass calcs

Design considerations for the batteries

- Lithium ion batteries
 - Option 1: one 120 Ah battery at ~30 kg, and max discharge of 59%
 - Option 3: one 80 Ah battery at ~20 kg, and max discharge of 56%

Design considerations for the electronics (same power electronics suite for both options)

- High Voltage Electronics Assembly (similar to the Dawn mission) interfaces with 100 V array
- Peak power tracker keeps array operating point near the max power point of the solar array IV curve at all times
- Provides a 100 V power bus for the 100 V PPU / SEP system
- Provides the 32 V power bus by down converting the 100 V array input V for the battery and the rest of spacecraft power needs
- Internally redundant

Power design rationale (design drivers are the same for both options studied)

- Array
 - Driving power mode: “Thrusting – Mars” due to its high power requirement in least favorable operating conditions
 - Design drivers: high power, low mass
 - Trade studies: none
- Batteries
 - Driving power mode: “Science – Night – SAR – Eclipse” due to its high depth of discharge in off sun operations
 - Design drivers: keep depth of discharge above 40%
 - Trade studies: none
- Electronics
 - Design Drivers: high voltage SEP system
 - Trade Studies: none

The cost for the power system is shown in Table B-56 (option 1) and Table B-57 (option 3).

Table B-56. Cost of power system for option 1.

Option 1	Total	Labor (\$k)	Services (\$k)	Procurements (\$k)
2025 \$K				
Subsystem Management	5907	5907	-	-
System Engineering	6672	6672	-	-
Power Source—Solar Array	38107	599	-	37508
Power Source—RPS	-	-	-	-
Energy Storage—Rechargeable Secondary Battery	2332	319	-	2012
Energy Storage—Primary Battery	-	-	-	-
Energy Storage—Thermal Battery	-	-	-	-
Electronics	25346	5642	4475	15229
BTE / GSE / I and T	5856	5175	571	111
Total	84220	24314	5046	54860

Table B-57. Cost of power system for option 3.

Option 3	Total	Labor (\$k)	Services (\$k)	Procurements (\$k)
2025 \$K				
Subsystem Management	3742	3742	-	-
System Engineering	4160	4160	-	-
Power Source—Solar Array	25685	599	-	25086
Power Source—RPS	-	-	-	-
Energy Storage—Rechargeable Secondary Battery	1552	319	-	1233
Energy Storage—Primary Battery	-	-	-	-
Energy Storage—Thermal Battery	-	-	-	-
Electronics	25346	5642	4475	15229
BTE / GSE / I and T	3843	3161	571	111
Total	64328	17624	5046	41659

Cost considerations

- Cost Drivers
 - Large solar array due to high power requirements
- Potential Cost Savings
 - Subsystem cost model heuristics drives subsystem management, engineering, and I&T
 - A grass roots cost might yield some reductions in these areas
- Potential Cost Uppers
 - Individual component bench test equipment (BTE) hardware and subsystem ground support equipment (GSE) assumed to inherited from previous missions using similar equipment with engineering to tailor (adapt, reprogram, etc.) to this mission
 - If this equipment is not available costs will increase

Risks

- There are not inherent risks specific to this mission with respect to the power subsystem.

B.4.10 Propulsion

Propulsion design

- SEP System: same for both options
 - Uses 2 gimbaled AEPS thrusters
 - With a standard EP Xenon feed system and a AEPS PPU
 - The Xenon tank is
 - Composite wrapped 1.1 meter near sphere (same height and diameter, but with cylindrical section and elliptical heads) with a maximum pressure (at max qual temp of 45 C) of 2500 psia
 - Option 1 is 1.1 m diameter, option 3 is 0.92 m diameter
 - Functionality
 - Provide maneuver delta V for both cruise and orbit changes at Mars
 - Provides drag makeup in Mars orbit
 - Provides some attitude control as gimbaled
- RCS System: same for both options
 - Uses eight MR-103 1 N (0.2 lb) monopropellant thrusters
 - With a typical blowdown feed system
 - The propellant tank is a titanium sphere with a diaphragm propellant management device
 - Option 1: 22“ diameter, option 3: 25“ diameter
 - Functionality
 - Provide ACS control in safe mode
 - Desaturates the ACS wheels
 - It could provide ACS during cruise

Propulsion design

- Option 1: fully instrumented Mothership
 - Propellant:
 - System 1 is 1495 kg Xenon (including residuals) for the SEP
 - System 2 is 53 kg Hydrazine (including residuals) Monoprop system
- Option 3: minimum size Mothership
 - Propellant
 - System 1 is 962 kg Xenon (including residuals) for the SEP
 - System 2 is 16 kg Hydrazine (including residuals) Monoprop system

Propulsion design rationale

- The SEP system design was per the MOSAIC study team. It is reasonable given the large size of the spacecraft and large delta V
- Trades
 - For option 3, with a smaller spacecraft, probably a STP-140 SEP system might work better
 - It would have a much lighter dry mass and lower cost
 - It also has a much lower Isp, so the Xenon mass would go up
 - This is a possible future trade

Propulsion cost conclusions

- Cost option 1, as shown in Table B-58.
 - The costs assume a class A timeline and workforce
 - Spares are included, as is an engineering model test unit
 - Cost is for both systems
 - For SEP alone is \$88.2M

- For Monoprop alone is \$20.68M
- Cost option 3, as shown in Table B-59
 - The costs assume a class B Discovery class timeline and workforce
 - Spares are included, as is an engineering model test unit
 - Cost is for both systems
 - For SEP alone is \$75.81M
 - For Monoprop alone is \$14.39M

Table B-58. Propulsion cost for option 1.

Propulsion Systems Engineering Cost Summary (\$K)									
Item	Type	Phase A	Phase B	Phase C1	Phase C2	Phase C3	Phase D1	Phase D2	Total
		15	15	14	14	13	19	4	\$k
.01 & .02 Management, Eng'g	Eng Labor \$	\$3050.8k	\$3050.8k	\$2847.4k	\$2847.4k	\$2644.0k	\$3864.3k	\$813.5k	\$19118.1k
.03 Components Engr	Eng Labor \$	\$0.0k	\$1334.9k	\$2304.4k	\$2304.4k	\$2139.8k	\$0.0k	\$0.0k	\$8083.6k
.04 GSE	Eng Labor \$	\$0.0k	\$0.0k	\$0.0k	\$482.7k	\$482.7k	\$0.0k	\$0.0k	\$965.5k
.05 I&T	Eng Labor \$	\$0.0k	\$0.0k	\$0.0k	\$2740.0k	\$2544.3k	\$0.0k	\$0.0k	\$5284.3k
.06 Prop loading & ATLO supt	Eng Labor \$	\$0.0k	\$0.0k	\$0.0k	\$0.0k	\$0.0k	\$285.3k	\$285.3k	\$570.7k
.04 GSE	Service \$	\$0.0k	\$0.0k	\$0.0k	\$579.4k	\$579.4k	\$0.0k	\$0.0k	\$1158.8k
.05 I&T	Service \$	\$0.0k	\$0.0k	\$0.0k	\$3975.2k	\$3716.1k	\$0.0k	\$0.0k	\$7691.2k
.06 Prop loading & ATLO supt	Service \$	\$0.0k	\$0.0k	\$0.0k	\$0.0k	\$0.0k	\$438.6k	\$438.6k	\$877.2k
Subtotal Labor and Services	Labor & Services \$	\$3050.8k	\$4385.7k	\$5151.8k	\$12929.2k	\$12106.3k	\$4588.2k	\$1537.5k	\$43749.5k
.03 Components	Subcontract Procurement \$		\$11140.0k	\$16990.5k	\$16990.5k	\$16990.5k		\$3014.0k	\$65125.5k
Non-Recurring	\$k	\$3050.8k	\$15525.7k	\$15261.5k	\$15261.5k	\$14967.1k	\$3091.4k	\$650.8k	\$67808.7k
Recurring	\$k	\$0.0k	\$0.0k	\$6880.9k	\$14658.2k	\$14129.8k	\$1496.8k	\$3900.7k	\$41066.3k
Total	\$k	\$3050.8k	\$15525.7k	\$22142.3k	\$29919.7k	\$29096.8k	\$4588.2k	\$4551.5k	\$108875.0k

Table B-59. Propulsion cost for option 3.

Propulsion Systems Engineering Cost Summary (\$K)									
Item	Type	Phase A	Phase B	Phase C1	Phase C2	Phase C3	Phase D1	Phase D2	Total
		12	12	11	6	5	14	4	\$k
.01 & .02 Management, Eng'g	Eng Labor \$	\$2440.6k	\$2440.6k	\$2237.2k	\$1220.3k	\$1016.9k	\$2847.4k	\$813.5k	\$13016.6k
.03 Components Engr	Eng Labor \$	\$0.0k	\$1067.9k	\$1810.6k	\$987.6k	\$823.0k	\$0.0k	\$0.0k	\$4689.2k
.04 GSE	Eng Labor \$	\$0.0k	\$0.0k	\$0.0k	\$482.7k	\$482.7k	\$0.0k	\$0.0k	\$965.5k
.05 I&T	Eng Labor \$	\$0.0k	\$0.0k	\$0.0k	\$1174.3k	\$978.6k	\$0.0k	\$0.0k	\$2152.9k
.06 Prop loading & ATLO supt	Eng Labor \$	\$0.0k	\$0.0k	\$0.0k	\$0.0k	\$0.0k	\$285.3k	\$285.3k	\$570.7k
.04 GSE	Service \$	\$0.0k	\$0.0k	\$0.0k	\$579.4k	\$579.4k	\$0.0k	\$0.0k	\$1158.8k
.05 I&T	Service \$	\$0.0k	\$0.0k	\$0.0k	\$1902.2k	\$1643.1k	\$0.0k	\$0.0k	\$3545.3k
.06 Prop loading & ATLO supt	Service \$	\$0.0k	\$0.0k	\$0.0k	\$0.0k	\$0.0k	\$438.6k	\$438.6k	\$877.2k
Subtotal Labor and Services	Labor & Services \$	\$2440.6k	\$3508.5k	\$4047.9k	\$6346.5k	\$5523.7k	\$3571.3k	\$1537.5k	\$26976.1k
.03 Components	Subcontract Procurement \$		\$11014.7k	\$16759.8k	\$16759.8k	\$16759.8k		\$1932.2k	\$63226.3k
Non-Recurring	\$k	\$2440.6k	\$14523.3k	\$14253.0k	\$12781.1k	\$12486.7k	\$2277.9k	\$650.8k	\$59413.5k
Recurring	\$k	\$0.0k	\$0.0k	\$6554.6k	\$10325.3k	\$9796.8k	\$1293.4k	\$2818.8k	\$30788.9k
Total	\$k	\$2440.6k	\$14523.3k	\$20807.7k	\$23106.3k	\$22283.5k	\$3571.3k	\$3469.6k	\$90202.4k

Table B-60 shows the cost comparison for the two options.

Table B-60. Option comparison for propulsion cost.

Option	DRY Mass (kg)	Cost (\$M)	Thrusters	Tank Size	Propellant mass (kg)	Comments
1	274.3 (CBE)	108.9	2, AEPS + 8, MR-103	1.1 m Composite + 22" Titanium	1495 Xenon + 53 Hydrazine	
3	249.3 (CBE)	90.2	2, AEPS + 8, MR-103	.92 m Composite + 15" Titanium	962 Xenon + 16 Hydrazine	

B.4.11 Thermal

Design assumptions

- Spacecraft honeycomb shear panels are used as radiators (dual-use) and no mass or costs (other than coatings and constant conductance heat pipes within the honeycomb sandwich) are carried by Thermal.
- Radiator and heater sizing based on an allowable temperature range of -20°C to $+50^{\circ}\text{C}$.
- When sizing survival heaters, a worst case assumption of a 93 K radiative sink temperature is assumed (conservative, given that the effective sink temperature for a port/starboard radiator will be no lower than 180 K).
- PPU is 93% efficient with max allowable operating temperature of 50°C .
- Solar array switching is used in a way that precludes the need for a shunt radiator.

Thermal design

- The thermal design is a high heritage, passive design. The system is cold biased with radiators sized for the worst case hot condition (SEP thrusting at 1 AU). Make-up heater power is then used to maintain minimum allowable temperatures during cold scenarios. Propellant tanks and lines are covered with MLI. Option 1 and Option 3 thermal design are nearly identical. The exception being that Option 3 requires a bit smaller radiator area, less heater power, and less thermal HW mass due to the decreased propellant and system power draw.
- Hardware
 - Heaters are controlled using mechanical thermostats
 - PRT temperature sensors
 - 17-layer MLI
 - 8.5 m^2 for Option 1 and 6.1 m^2 for Option 3 of bus structure is left exposed and serves as the radiator.
 - Half of the radiator area is on the port and half on the starboard sides of the spacecraft structure
 - Due to the relatively high heat flux associated with PPUs and telecon equipment, constant conductance, aluminum/ammonia heat pipes are embedded within the port and starboard panels in order to distribute heat across the radiator surfaces
 - 10-mil silverized Teflon coating on radiator

Thermal design rationale

The amount of make-up heater power is rather excessive for those modes where SEP is not active. Normally, the Thermal subsystem would implement a radiator turn-down device, such as louvers, to conserve heater power. However, a discussion with the Team X power chair resulted in a decision to

save on lower costs (~\$1M) at the expense of heater power due to the abundance of available power in those modes.

Thermal cost

- Option 1: \$11M total thermal subsystem costs (see Figure B-36)
 - \$8.3M Labor costs
 - \$2.7M Hardware costs
 - MLI materials and services costs
 - Heat pipes within radiator panels
- Option 3: \$7.8M total thermal subsystem costs (see Figure B-37)
 - \$5.3M labor costs
 - \$2.3M hardware costs
 - MLI materials and services costs
 - Heat pipes within radiator panels

Phase Duration	Thermal Control System Resources by Phase							Thermal Control System Cost			
	A 15 mo.	B 15 mo.	C1 14 mo.	C2 14 mo.	C3 13 mo.	D1 19 mo.	D2 4 mo.	Total 94 mo.	Total 94 mo.	NRE (A-C1) 44 mo.	RE (C2-D2) 50 mo.
06.08 Thermal Control System	0.5 FTE	3.5 FTE	5.5 FTE	2.2 FTE	2.4 FTE	1.7 FTE	0.0 FTE	19.4 WY	\$11062.9 K	\$5064.0 K	\$5999.0 K
06.08.01 Mgmt and Sys. Eng.	0.5 FTE	1.1 FTE	1.6 FTE	0.7 FTE	0.7 FTE	0.6 FTE	0.0 FTE	6.4 WY	\$3300.3 K	\$1982.1 K	\$1318.2 K
06.08.01.01 Management	0.0 FTE	0.3 FTE	0.5 FTE	0.2 FTE	0.2 FTE	0.2 FTE	0.0 FTE	1.8 WY	\$1317.9 K	\$780.7 K	\$537.2 K
Management Support	0.0 FTE	0.3 FTE	0.5 FTE	0.2 FTE	0.2 FTE	0.2 FTE	0.0 FTE	1.8 WY	\$765.4 K	\$453.4 K	\$312.0 K
Secretary Support	0.0 FTE	0.0 FTE	0.0 FTE	0.0 FTE	0.0 FTE	0.0 FTE	0.0 FTE	0.0 WY	\$0.0 K	\$0.0 K	\$0.0 K
Computer HW/SW Support	\$18.8 K	\$124.5 K	\$184.0 K	\$74.5 K	\$73.3 K	\$77.4 K	\$0.0 K	\$552.5 K	\$552.5 K	\$327.3 K	\$225.2 K
06.08.01.02 System Engineering	0.5 FTE	0.8 FTE	1.1 FTE	0.5 FTE	0.5 FTE	0.5 FTE	0.0 FTE	4.7 WY	\$1982.4 K	\$1201.4 K	\$781.0 K
Project Engineer	0.0 FTE	0.0 FTE	0.0 FTE	0.0 FTE	0.0 FTE	0.0 FTE	0.0 FTE	0.0 WY	\$0.0 K	\$0.0 K	\$0.0 K
Lead Engineer (Engineering 4)	0.5 FTE	0.8 FTE	1.1 FTE	0.5 FTE	0.5 FTE	0.5 FTE	0.0 FTE	4.7 WY	\$1982.4 K	\$1201.4 K	\$781.0 K
Sys Engineer (Engineering 3)	0.0 FTE	0.0 FTE	0.0 FTE	0.0 FTE	0.0 FTE	0.0 FTE	0.0 FTE	0.0 WY	\$0.0 K	\$0.0 K	\$0.0 K
Sys Engineer (Engineering 1-2)	0.0 FTE	0.0 FTE	0.0 FTE	0.0 FTE	0.0 FTE	0.0 FTE	0.0 FTE	0.0 WY	\$0.0 K	\$0.0 K	\$0.0 K
06.08.02 Analysis/Design	0.0 FTE	2.3 FTE	3.4 FTE	0.6 FTE	0.6 FTE	0.6 FTE	0.0 FTE	9.1 WY	\$3639.5 K	\$2686.3 K	\$953.1 K
Analysis Engineer (Engineering 4)	0.0 FTE	1.1 FTE	1.1 FTE	0.5 FTE	0.5 FTE	0.5 FTE	0.0 FTE	4.4 WY	\$1868.3 K	\$1087.3 K	\$781.0 K
Analysis Engineer (Engineering 3)	0.0 FTE	1.1 FTE	2.1 FTE	0.0 FTE	0.0 FTE	0.0 FTE	0.0 FTE	3.8 WY	\$1421.3 K	\$1421.3 K	\$0.0 K
Analysis Engineer (Engineering 1-2)	0.0 FTE	0.0 FTE	0.0 FTE	0.0 FTE	0.0 FTE	0.0 FTE	0.0 FTE	0.0 WY	\$0.0 K	\$0.0 K	\$0.0 K
Development Testing	\$0.0 K	\$0.0 K	\$0.0 K	\$0.0 K	\$0.0 K	\$0.0 K	\$0.0 K	\$0.0 K	\$0.0 K	\$0.0 K	\$0.0 K
Planetary Protection	0.0 FTE	0.1 FTE	0.3 FTE	0.1 FTE	0.1 FTE	0.1 FTE	0.0 FTE	0.9 WY	\$349.8 K	\$177.7 K	\$172.1 K
PP Lead Engineer	0.0 FTE	0.0 FTE	0.0 FTE	0.0 FTE	0.0 FTE	0.0 FTE	0.0 FTE	0.0 WY	\$0.0 K	\$0.0 K	\$0.0 K
PP Analysis / Design	0.0 FTE	0.1 FTE	0.3 FTE	0.1 FTE	0.1 FTE	0.1 FTE	0.0 FTE	0.9 WY	\$349.8 K	\$177.7 K	\$172.1 K
PP Testing / HW	\$0.0 K	\$0.0 K	\$0.0 K	\$0.0 K	\$0.0 K	\$0.0 K	\$0.0 K	\$0.0 K	\$0.0 K	\$0.0 K	\$0.0 K
06.08.03 Hardware	0.0 FTE	0.1 FTE	0.3 FTE	0.5 FTE	0.1 FTE	0.0 FTE	0.0 FTE	1.2 WY	\$3038.2 K	\$272.1 K	\$2766.1 K
HW Support Engineer (Engineering 4)	0.0 FTE	0.0 FTE	0.0 FTE	0.0 FTE	0.0 FTE	0.0 FTE	0.0 FTE	0.0 WY	\$0.0 K	\$0.0 K	\$0.0 K
HW Support Engineer (Engineering 3)	0.0 FTE	0.1 FTE	0.3 FTE	0.5 FTE	0.1 FTE	0.0 FTE	0.0 FTE	1.2 WY	\$435.9 K	\$177.7 K	\$258.2 K
HW Support Engineer (Engineering 1-2)	0.0 FTE	0.0 FTE	0.0 FTE	0.0 FTE	0.0 FTE	0.0 FTE	0.0 FTE	0.0 WY	\$0.0 K	\$0.0 K	\$0.0 K
Flight HW	\$0.0 K	\$0.0 K	\$94.5 K	#####	\$0.0 K	\$0.0 K	\$0.0 K	#####	\$2602.4 K	\$94.5 K	\$2507.9 K
Flight HW Testing HW	\$0.0 K	\$0.0 K	\$0.0 K	\$0.0 K	\$0.0 K	\$0.0 K	\$0.0 K	\$0.0 K	\$0.0 K	\$0.0 K	\$0.0 K
06.08.04 BCE/AHSE/GSE	0.0 FTE	0.0 FTE	0.1 FTE	0.2 FTE	0.5 FTE	0.5 FTE	0.0 FTE	1.7 WY	\$727.8 K	\$65.6 K	\$662.1 K
H/WTest Engineer (Engineering 4)	0.0 FTE	0.0 FTE	0.1 FTE	0.2 FTE	0.5 FTE	0.5 FTE	0.0 FTE	1.7 WY	\$727.8 K	\$65.6 K	\$662.1 K
H/WTest Engineer (Engineering 3)	0.0 FTE	0.0 FTE	0.0 FTE	0.0 FTE	0.0 FTE	0.0 FTE	0.0 FTE	0.0 WY	\$0.0 K	\$0.0 K	\$0.0 K
H/WTest Engineer (Engineering 1-2)	0.0 FTE	0.0 FTE	0.0 FTE	0.0 FTE	0.0 FTE	0.0 FTE	0.0 FTE	0.0 WY	\$0.0 K	\$0.0 K	\$0.0 K
BCE/AHSE/GSE	\$0.0 K	\$0.0 K	\$0.0 K	\$0.0 K	\$0.0 K	\$0.0 K	\$0.0 K	\$0.0 K	\$0.0 K	\$0.0 K	\$0.0 K
06.08.05 Integration And Test	0.0 FTE	0.0 FTE	0.1 FTE	0.2 FTE	0.5 FTE	0.0 FTE	0.0 FTE	1.0 WY	\$357.2 K	\$57.8 K	\$299.4 K
Subsystem Integration and Test	0.0 FTE	0.0 FTE	0.1 FTE	0.2 FTE	0.5 FTE	0.0 FTE	0.0 FTE	1.0 WY	\$357.2 K	\$57.8 K	\$299.4 K
I&T Engineer (Engineering 4)	0.0 FTE	0.0 FTE	0.0 FTE	0.0 FTE	0.0 FTE	0.0 FTE	0.0 FTE	0.0 WY	\$0.0 K	\$0.0 K	\$0.0 K
I&T Engineer (Engineering 3)	0.0 FTE	0.0 FTE	0.1 FTE	0.2 FTE	0.5 FTE	0.0 FTE	0.0 FTE	1.0 WY	\$357.2 K	\$57.8 K	\$299.4 K
I&T Engineer (Engineering 1-2)	0.0 FTE	0.0 FTE	0.0 FTE	0.0 FTE	0.0 FTE	0.0 FTE	0.0 FTE	0.0 WY	\$0.0 K	\$0.0 K	\$0.0 K
System Integration and Test	0.0 FTE	0.0 FTE	0.0 FTE	0.0 FTE	0.0 FTE	0.0 FTE	0.0 FTE	0.0 WY	\$0.0 K	\$0.0 K	\$0.0 K
I&T Engineer (Engineering 4)	0.0 FTE	0.0 FTE	0.0 FTE	0.0 FTE	0.0 FTE	0.0 FTE	0.0 FTE	0.0 WY	\$0.0 K	\$0.0 K	\$0.0 K
I&T Engineer (Engineering 3)	0.0 FTE	0.0 FTE	0.0 FTE	0.0 FTE	0.0 FTE	0.0 FTE	0.0 FTE	0.0 WY	\$0.0 K	\$0.0 K	\$0.0 K
I&T Engineer (Engineering 1-2)	0.0 FTE	0.0 FTE	0.0 FTE	0.0 FTE	0.0 FTE	0.0 FTE	0.0 FTE	0.0 WY	\$0.0 K	\$0.0 K	\$0.0 K

Figure B-36. Thermal cost for option 1.

Phase Duration	Thermal Control System Resources by Phase								Thermal Control System Cost			
	A 12 mo.	B 12 mo.	C1 11 mo.	C2 6 mo.	C3 5 mo.	D1 14 mo.	D2 4 mo.	Total 64 mo.	Total 64 mo.	NRE (A-C1) 35 mo.	RE (C2-D2) 29 mo.	
06.08 Thermal Control System	0.5 FTE	3.1 FTE	4.8 FTE	2.7 FTE	2.9 FTE	1.7 FTE	0.0 FTE	12.5 WY	\$7759.4 K	\$3568.2 K	\$4191.2 K	
06.08.01 Mgmt and Sys. Eng.	0.5 FTE	1.0 FTE	1.4 FTE	0.8 FTE	0.9 FTE	0.6 FTE	0.0 FTE	4.2 WY	\$2182.3 K	\$1388.3 K	\$764.2 K	
06.08.01.01 Management	0.0 FTE	0.3 FTE	0.4 FTE	0.2 FTE	0.3 FTE	0.2 FTE	0.0 FTE	1.1 WY	\$852.2 K	\$545.6 K	\$306.6 K	
Management Support	0.0 FTE	0.3 FTE	0.4 FTE	0.2 FTE	0.3 FTE	0.2 FTE	0.0 FTE	1.1 WY	\$495.0 K	\$316.9 K	\$178.1 K	
Secretary Support	0.0 FTE	0.0 FTE	0.0 FTE	0.0 FTE	0.0 FTE	0.0 FTE	0.0 FTE	0.0 WY	\$0.0 K	\$0.0 K	\$0.0 K	
Computer HW/SW Support	\$13.3 K	\$89.3 K	\$126.1 K	\$39.1 K	\$34.5 K	\$54.9 K	\$0.0 K	\$357.2 K	\$357.2 K	\$228.7 K	\$128.5 K	
06.08.01.02 System Engineering	0.4 FTE	0.7 FTE	0.9 FTE	0.6 FTE	0.6 FTE	0.5 FTE	0.0 FTE	3.1 WY	\$1300.3 K	\$842.7 K	\$457.6 K	
Project Engineer	0.0 FTE	0.0 FTE	0.0 FTE	0.0 FTE	0.0 FTE	0.0 FTE	0.0 FTE	0.0 WY	\$0.0 K	\$0.0 K	\$0.0 K	
Lead Engineer (Engineering 4)	0.4 FTE	0.7 FTE	0.9 FTE	0.6 FTE	0.6 FTE	0.5 FTE	0.0 FTE	3.1 WY	\$1300.3 K	\$842.7 K	\$457.6 K	
Sys Engineer (Engineering 3)	0.0 FTE	0.0 FTE	0.0 FTE	0.0 FTE	0.0 FTE	0.0 FTE	0.0 FTE	0.0 WY	\$0.0 K	\$0.0 K	\$0.0 K	
Sys Engineer (Engineering 1-2)	0.0 FTE	0.0 FTE	0.0 FTE	0.0 FTE	0.0 FTE	0.0 FTE	0.0 FTE	0.0 WY	\$0.0 K	\$0.0 K	\$0.0 K	
06.08.02 Analysis/Design	0.0 FTE	2.0 FTE	3.0 FTE	0.7 FTE	0.7 FTE	0.6 FTE	0.0 FTE	6.1 WY	\$2435.4 K	\$1877.0 K	\$558.5 K	
Analysis Engineer (Engineering 4)	0.0 FTE	1.0 FTE	0.9 FTE	0.6 FTE	0.6 FTE	0.5 FTE	0.0 FTE	2.9 WY	\$1220.7 K	\$763.1 K	\$457.6 K	
Analysis Engineer (Engineering 3)	0.0 FTE	1.0 FTE	1.9 FTE	0.0 FTE	0.0 FTE	0.0 FTE	0.0 FTE	2.6 WY	\$990.1 K	\$990.1 K	\$0.0 K	
Analysis Engineer (Engineering 1-2)	0.0 FTE	0.0 FTE	0.0 FTE	0.0 FTE	0.0 FTE	0.0 FTE	0.0 FTE	0.0 WY	\$0.0 K	\$0.0 K	\$0.0 K	
Development Testing	\$0.0 K	\$0.0 K	\$0.0 K	\$0.0 K	\$0.0 K	\$0.0 K	\$0.0 K	\$0.0 K	\$0.0 K	\$0.0 K	\$0.0 K	
Planetary Protection	0.0 FTE	0.1 FTE	0.2 FTE	0.1 FTE	0.1 FTE	0.1 FTE	0.0 FTE	0.6 WY	\$224.6 K	\$123.8 K	\$100.9 K	
PP Lead Engineer	0.0 FTE	0.0 FTE	0.0 FTE	0.0 FTE	0.0 FTE	0.0 FTE	0.0 FTE	0.0 WY	\$0.0 K	\$0.0 K	\$0.0 K	
PP Analysis / Design	0.0 FTE	0.1 FTE	0.2 FTE	0.1 FTE	0.1 FTE	0.1 FTE	0.0 FTE	0.6 WY	\$224.6 K	\$123.8 K	\$100.9 K	
PP Testing / HW	\$0.0 K	\$0.0 K	\$0.0 K	\$0.0 K	\$0.0 K	\$0.0 K	\$0.0 K	\$0.0 K	\$0.0 K	\$0.0 K	\$0.0 K	
06.08.03 Hardware	0.0 FTE	0.1 FTE	0.2 FTE	0.6 FTE	0.1 FTE	0.0 FTE	0.0 FTE	0.7 WY	\$2544.9 K	\$218.2 K	\$2326.7 K	
HW Support Engineer (Engineering 4)	0.0 FTE	0.0 FTE	0.0 FTE	0.6 FTE	0.0 FTE	0.0 FTE	0.0 FTE	0.0 WY	\$0.0 K	\$0.0 K	\$0.0 K	
HW Support Engineer (Engineering 3)	0.0 FTE	0.1 FTE	0.2 FTE	0.6 FTE	0.1 FTE	0.0 FTE	0.0 FTE	0.7 WY	\$256.6 K	\$123.8 K	\$132.8 K	
HW Support Engineer (Engineering 1-2)	0.0 FTE	0.0 FTE	0.0 FTE	0.0 FTE	0.0 FTE	0.0 FTE	0.0 FTE	0.0 WY	\$0.0 K	\$0.0 K	\$0.0 K	
Flight HW	\$0.0 K	\$0.0 K	\$94.5 K	#####	\$0.0 K	\$0.0 K	\$0.0 K	\$2288.3 K	\$2288.3 K	\$94.5 K	\$2193.9 K	
Flight HW Testing HW	\$0.0 K	\$0.0 K	\$0.0 K	\$0.0 K	\$0.0 K	\$0.0 K	\$0.0 K	\$0.0 K	\$0.0 K	\$0.0 K	\$0.0 K	
06.08.04 BCE/AHSE/GSE	0.0 FTE	0.0 FTE	0.1 FTE	0.3 FTE	0.6 FTE	0.5 FTE	0.0 FTE	1.0 WY	\$440.3 K	\$45.0 K	\$395.3 K	
H/WTest Engineer (Engineering 4)	0.0 FTE	0.0 FTE	0.1 FTE	0.3 FTE	0.6 FTE	0.5 FTE	0.0 FTE	1.0 WY	\$440.3 K	\$45.0 K	\$395.3 K	
H/WTest Engineer (Engineering 3)	0.0 FTE	0.0 FTE	0.0 FTE	0.0 FTE	0.0 FTE	0.0 FTE	0.0 FTE	0.0 WY	\$0.0 K	\$0.0 K	\$0.0 K	
H/WTest Engineer (Engineering 1-2)	0.0 FTE	0.0 FTE	0.0 FTE	0.0 FTE	0.0 FTE	0.0 FTE	0.0 FTE	0.0 WY	\$0.0 K	\$0.0 K	\$0.0 K	
BCE/AHSE/GSE	\$0.0 K	\$0.0 K	\$0.0 K	\$0.0 K	\$0.0 K	\$0.0 K	\$0.0 K	\$0.0 K	\$0.0 K	\$0.0 K	\$0.0 K	
06.08.05 Integration And Test	0.0 FTE	0.0 FTE	0.1 FTE	0.3 FTE	0.6 FTE	0.0 FTE	0.0 FTE	0.5 WY	\$186.2 K	\$39.7 K	\$146.6 K	
Subsystem Integration and Test	0.0 FTE	0.0 FTE	0.1 FTE	0.3 FTE	0.6 FTE	0.0 FTE	0.0 FTE	0.5 WY	\$186.2 K	\$39.7 K	\$146.6 K	
I&T Engineer (Engineering 4)	0.0 FTE	0.0 FTE	0.0 FTE	0.0 FTE	0.0 FTE	0.0 FTE	0.0 FTE	0.0 WY	\$0.0 K	\$0.0 K	\$0.0 K	
I&T Engineer (Engineering 3)	0.0 FTE	0.0 FTE	0.1 FTE	0.3 FTE	0.6 FTE	0.0 FTE	0.0 FTE	0.5 WY	\$186.2 K	\$39.7 K	\$146.6 K	
I&T Engineer (Engineering 1-2)	0.0 FTE	0.0 FTE	0.0 FTE	0.0 FTE	0.0 FTE	0.0 FTE	0.0 FTE	0.0 WY	\$0.0 K	\$0.0 K	\$0.0 K	
System Integration and Test	0.0 FTE	0.0 FTE	0.0 FTE	0.0 FTE	0.0 FTE	0.0 FTE	0.0 FTE	0.0 WY	\$0.0 K	\$0.0 K	\$0.0 K	
I&T Engineer (Engineering 4)	0.0 FTE	0.0 FTE	0.0 FTE	0.0 FTE	0.0 FTE	0.0 FTE	0.0 FTE	0.0 WY	\$0.0 K	\$0.0 K	\$0.0 K	
I&T Engineer (Engineering 3)	0.0 FTE	0.0 FTE	0.0 FTE	0.0 FTE	0.0 FTE	0.0 FTE	0.0 FTE	0.0 WY	\$0.0 K	\$0.0 K	\$0.0 K	
I&T Engineer (Engineering 1-2)	0.0 FTE	0.0 FTE	0.0 FTE	0.0 FTE	0.0 FTE	0.0 FTE	0.0 FTE	0.0 WY	\$0.0 K	\$0.0 K	\$0.0 K	

Figure B-37. Thermal cost for option 3.

Risks

- For both Options 1 and 3, if heater power draw is found to be excessive, a radiator turn-down device (e.g., louvers) would be required. Depending on the need for heater power reduction, the cost upper can be several millions of dollars.
- Although the radiators can be located on any side with slight modifications to their sizing, this Team X design study assumed two radiators of equal size on the sides attached to the solar arrays. There is a risk that those sides will be covered by the arrays during launch, in which case a third radiator will be required for those components which will be dissipating power prior to solar array deploy.

Cost comparison

- Options 1 and 3 have some differences due to the smaller propulsion system and power draw associated with Option 3. This results in less heating and a smaller radiator than that of Option 1. See Table B-61 for more details.

Table B-61. Thermal cost option comparison.

Option	Mass (kg)	Cost (\$M)	Radiator size (m ²)	Comments
1	59 (PBE)	11.3	8.5	Class A. Full instrument suite
3	52 (PBE)	7.8	6.1	Class B. Reduced instrument suite. Modified Schedule

B.4.12 CDS

Design assumptions

- Dual String Spacecraft
 - Option 1: Mission Class A (Flagship)
 - Option 3: Mission Class B (New Frontiers)
- Lifetime ~4 Earth years
 - 1 year cruise to Mars
 - 1 year installation of constellation elements in orbit at Mars
 - Full Science Operation for one Mars year (= 2 Earth years)
- Mothership delivers constellation of SmallSats to Mars
 - SmallSats each navigate to individual orbits
- Mothership serves as communication relay
 - Communications opportunities are sufficient for science data

Data story

- Data generation
 - Data from local instruments and SmallSat fleet
 - Option 1: ~160 Gbits/sol
 - Option 3: ~13 Gbits/sol
- Data transmission
 - Varies per Earth-Mars distance
 - Option 1
 - At 0.5 AU: 76 Mbits/sec in 0.6 hours
 - At 1.5 AU: 8.6 Mbits/sec in 5.3 hours
 - At 2.5 AU: 3 Mbits/sec in 15.1 hours
 - Option 3
 - At 0.5 AU: 9.65 Mbits/sec in 0.4 hours
 - At 1.5 AU: 1.1 Mbits/sec in 3.3 hours
 - At 2.5 AU: 0.387 Mbits/sec in 9.3 hours

Design

- Hardware
 - JPL Reference Bus system. Main Box: RAD750, NVM*, 2 MTIF, MSIA, MCIC, CRC, LEU-A/D
 - Option 1 includes NVM to accommodate instrument data (primarily SAR and Sounder)
 - Option 3 does not need NVM
 - Additional MTIF to accommodate relays with smallsats
- Functionality
 - General system functions: uplink, downlink, control, sequencing, etc.
- Redundancy
 - Single fault tolerant; dual string

Design rationale

- Data generation of ~20 Gbytes/day drives separate memory card (only in option 1)
- Relay of SmallSat data drives additional MTIF card

Cost assumptions

- Hardware to be built:
 - 2 strings each Flight, EM, and Prototype hardware

- 1 string Flight Spare
- 2 sets of GSE equipment
- 1 set of BTE equipment
- Standard simulators
- Hardware build includes two (2) testbeds
 - One each for Avionics and System testing
- Includes REU for Power subsystem

CDS cost

- Option 1: see Table B-62
 - 1st Unit Cost : \$84.9M
 - Nth Unit Cost: \$38.2M
- Option 3: see Table B-63
 - 1st Unit Cost : \$55.3M
 - Nth Unit Cost: \$35.1M

Table B-62. CDS cost option 1.

Task ID	2328 Mars Pre-Decadal MOSAIC 2020-03	A	B	C1	C2	C3	D1	D2	E	F	Total
06.05	Total Cost (K\$)	3979.3	22535.0	23454.1	10806.4	14108.3	8443.6	1524.8	0.0	0.0	84851.3
	Labor Total (FTE)	112.50	396.23	393.25	296.82	305.37	238.71	43.11	0.00	0.00	148.83
06.05.01	Subtotal Cost–Subsystem Management	530.6	1061.1	990.4	990.4	919.70	1344.1	141.5	0.0	0.0	5977.7
	Labor (FTE)	15.00	30.00	28.00	28.00	26.00	38.00	4.00	0.00	0.00	14.08
06.05.02	Subtotal Cost–Subsystem Engineering	1857.0	3183.4	3466.4	3466.4	3218.8	4032.3	495.2	0.0	0.0	19719.4
	Labor (FTE)	52.50	90.00	98.00	98.00	91.00	114.00	14.00	0.00	0.00	46.46
06.05.03	Subtotal Cost–C&DH Hardware	0.0	8015.4	8761.0	1233.7	4226.6	843.9	793.3	0.0	0.0	23873.9
	Labor (FTE)	0.00	12.50	18.36	28.86	26.00	23.86	22.43	0.00	0.00	11.00
06.05.05	Subtotal Cost–Sim. & Support Equipment (SSE)	1061.1	7622.2	6663.90	2427.7	1109.6	65.7	24.0	0.0	0.0	18974.2
	Labor (FTE)	30.00	188.73	147.90	65.96	31.37	1.86	0.68	0.00	0.00	38.88
06.05.06	Subtotal Cost–I&T	530.6	2652.8	3572.5	2688.2	4633.6	2157.6	70.7	0.0	0.0	16306.1
	Labor (FTE)	15.00	75.00	101.00	76.00	131.00	61.00	2.00	0.00	0.00	38.42

Table B-63. CDS cost option 3.

Task ID	2328 Mars Pre-Decadal MOSAIC 2020-03	A	B	C1	C2	C3	D1	D2	E	F	Total
06.05	Total Cost (K\$)	1485.6	17838.0	17851.0	4710.4	8644.4	3608.0	1197.2	0.0	0.0	55334.7
	Labor Total (FTE)	42.00	283.16	263.51	124.74	159.29	102.00	33.85	0.00	0.00	84.05
06.05.01	Subtotal Cost–Subsystem Management	424.5	424.5	389.1	212.2	176.9	495.2	141.5	0.0	0.0	2263.8
	Labor (FTE)	12.00	12.00	11.00	6.00	5.00	14.00	4.00	0.00	0.00	5.33
06.05.02	Subtotal Cost–Subsystem Engineering	848.9	1485.6	1556.3	848.9	707.4	1238.0	283.0	0.0	0.0	6968.1
	Labor (FTE)	24.00	42.00	44.00	24.00	20.00	35.00	8.00	0.00	0.00	16.42
06.05.03	Subtotal Cost–C&DH Hardware	0.0	7417.0	7874.1	1251.4	3883.3	802.3	747.5	0.0	0.0	21975.6
	Labor (FTE)	0.00	13.38	19.57	29.36	24.68	22.68	21.13	0.00	0.00	10.90
06.05.05	Subtotal Cost–Sim. & Support Equipment (SSE)	212.2	6883.9	5767.7	1313.2	574.4	6.57	25.3	0.0	0.0	14842.3
	Labor (FTE)	6.00	169.78	124.94	34.71	16.24	1.86	0.71	0.00	0.00	29.52
06.05.06	Subtotal Cost–I&T	0.0	1627.1	2263.8	1084.7	3302.5	1006.9	0.0	0.0	0.0	9284.9
	Labor (FTE)	0.00	46.00	64.00	30.67	93.37	28.47	0.00	0.00	0.00	21.88

B.4.13 Telecom

Design assumptions

- Operational Assumptions
 - Flyby S/C is 3-axis stabilized
 - S/C will continue to take science data of Mars during downlink passes. This is possible through a gimbaled HGA
- Antenna Assumptions
 - HGA is gimbaled and will be pointed within 0.1 degrees
 - Two LGAs will be positioned on opposite sides of the S/C to provide 2π steradian coverage
- Ground Station Assumptions
 - 34 m BWG DSN ground stations with 20 kW transmitters
- Coding Assumptions
 - Assumed Turbo rate 1/6 encoding for links
- Link Assumptions
 - 95% weather for all Ka-band links

Design Option 1

- Overall system description
 - For all options, telecom is a fully redundant X/Ka-band system
 - Telecom has a redundant design for the DTE X-Band link and two parallel systems for the UHF receivers for the probe data
- Hardware Includes:
 - One 3 m X/Ka-band HGA, gimbaled
 - 57 dBi gain at Ka-band
 - Two X-band low gain antennas (are installed on the HGA gimbal as well)
 - 8 dBi gain
 - Two UHF low gain helix antennas
 - Two UHF/X/Ka-band UST
 - X and Ka-band downlink, X-band for safe mode and housekeeping downlink (lower power), Ka-band for high-rate science downlink
 - X-band uplink
 - Two 25 W X-band TWTAs
 - Two 200 W Ka-band TWTAs
 - Filters, diplexers, waveguide transfer switches, waveguide, and coax cabling
- Estimated total mass of 70.3 kg (CBE), 80.2 kg (MEV)

Design Option 3

- Overall system description
 - For all options, telecom is a fully redundant X/Ka-band system
 - Telecom has a redundant design for the DTE X-Band link and two parallel systems for the UHF receivers for the probe data
- Hardware Includes:
 - One 1 m X/Ka-band HGA, gimbaled
 - Two X-band low gain antennas (are installed on the HGA gimbal as well)
 - 8 dBi gain
 - Two UHF low gain helix antennas
 - Two UHF/X/Ka-band UST

- X and Ka-band downlink, X-band for safe mode and housekeeping downlink (lower power), Ka-band for high-rate science downlink
- X-band uplink
- Two 25 W X-band TWTA's
- Two 200 W Ka-band TWTA's
- Filters, diplexers, waveguide transfer switches, waveguide, and coax cabling
- Estimated total mass of 58.9 kg (CBE), 67.2 kg (MEV)

Design rationale (for both options)

- Rationale for frequencies
 - Ka-band needed for data rates required, X-band used for uplink and housekeeping and/or backup downlink capability
 - UHF for relay to other orbiting assets
- Rationale for hardware
 - Using next generation transponding technology
 - UST is reprogrammable in flight, offering flexibility
 - Advanced signal processing capabilities for anomaly investigation and resolution
 - 200 W TWTA (with 377 W DC consumption) acceptable on a SEP mission
- DTE/DFE Link Capabilities:
 - Downlink data rates at Ka-band both options are shown in Table B-64.
 - Uplink data rate of 2 kbps supported through all mission phases (at X-band)

Table B-64. Downlink data rates at K-band for both options.

Link Description	0.5 AU–Ka-band Downlink	1.5 AU–Ka-band Downlink	2.5 AU –Ka-band Downlink
Option 1 Data Rate (3 m HGA, 200 TWTA)	76 Mbps	8.3 Mbps	3 Mbps
Option 2 Data Rate (1 m HGA, 200 W TWTA)	9.7 Mbps	1.1 Mbps	388 kbps

Costing assumptions (for both options)

- Development for 200 W Ka-band TWTA included
- No spares
- Costs and mass for antenna gimbal carried by the Team X mechanical chair
- Costs for telecom support to ATLO carried by the Team X systems chair
- No telecom hardware or support is included for testbeds

Cost

- Option 1 (see Table B-65)
 - NRE: \$42.0M
 - RE: 31.4M
 - Total: \$73.4M
- Option 3 (see Table B-66)
 - NRE: \$36.4M
 - RE: \$24.1M
 - Total: \$60.5M

Table B-65. Telecom cost for option 1.

	Phase A	Phase B	Phase C			Phase D		Total
			Subsystem Design	Subsystem Fabrication	Subsystem I&T	System Level IA&T	Launch Operations	
WBS	15.0 months	15.0 months	14.0 months	14.0 months	13.0 months	19.0 months	4.0 months	\$73396
6.06 Telecom Subsystem	\$1145	\$15532	\$33202	\$8851	\$9518	\$4735	\$414	\$73396
06.06.01 Telecom Management	\$614	\$1219	\$1381	\$1322	\$1318	\$1449	\$269	\$7572
06.06.02 Telecom System Engineering	\$531	\$1326	\$1238	\$1238	\$1150	\$1680	\$141	\$7304
06.06.03 Radios	\$0	\$7613	\$10598	\$986	\$418	\$15	\$3	\$19633
06.06.04 Power Amplifiers	\$0	\$2027	\$7863	\$1045	\$46	\$0	\$0	\$10981
06.06.05 Antennas	\$0	\$2007	\$4075	\$1847	\$2556	\$0	\$0	\$10485
06.06.06 Optical Comm Assembly	\$0	\$0	\$0	\$0	\$0	\$0	\$0	\$0
06.06.08 Microwave Components	\$0	\$0	\$3624	\$382	\$0	\$0	\$0	\$4006
06.06.09 RFS I&T	\$0	\$1340	\$4422	\$2031	\$4030	\$1591	\$0	\$13414
06.06.10 Telecom Support to ATLO	\$0	\$0	\$0	\$0	\$0	\$0	\$0	\$0

Table B-66. Telecom cost for option 3.

	Phase A	Phase B	Phase C			Phase D		Total
			Subsystem Design	Subsystem Fabrication	Subsystem I&T	System Level IA&T	Launch Operations	
WBS	12.0 months	12.0 months	11.0 months	6.0 months	5.0 months	14.0 months	4.0 months	\$60486
6.06 Telecom Subsystem	\$646	\$14045	\$31601	\$5521	\$5138	\$3170	\$366	\$60486
06.06.01 Telecom Management	\$221	\$643	\$666	\$366	\$365	\$436	\$149	\$2846
06.06.02 Telecom System Engineering	\$424	\$1061	\$973	\$603	\$442	\$1238	\$141	\$4883
06.06.03 Radios	\$0	\$8420	\$11112	\$1266	\$579	\$276	\$75	\$21729
06.06.04 Power Amplifiers	\$0	\$1857	\$7693	\$448	\$18	\$0	\$0	\$10016
06.06.05 Antennas	\$0	\$1418	\$4111	\$1594	\$2184	\$0	\$0	\$9307
06.06.06 Optical Comm Assembly	\$0	\$0	\$0	\$0	\$0	\$0	\$0	\$0
06.06.08 Microwave Components	\$0	\$0	\$3626	\$210	\$0	\$0	\$0	\$3836
06.06.09 RFS I&T	\$0	\$646	\$3420	\$1033	\$1550	\$1220	\$0	\$7869
06.06.10 Telecom Support to ATLO	\$0	\$0	\$0	\$0	\$0	\$0	\$0	\$0

Risks

- Low telecom risk mission
 - Most components have heritage from MRO
 - Small development needed for 200 W Ka-band TWTA
 - Includes X-band backup for science downlink, in the event of weather affecting Ka-band downlink transmission
 - Spares not included in this cost
 - Cost increase for single spares for major components (radio, TWTAs, LGAs) is approximately \$5M in FY2025 dollars

Technology development opportunities

- Design includes next-generation UST for telecom radio, includes development for this (albeit small)
- Design includes 200 W Ka-band TWTA, which is at TRL 6, and costs are included to develop this technology further. Flying a 200 W Ka-band TWTA would advance Ka-band technology at Mars considerably (many concepts look to using a 200 W Ka-band TWTA at Mars)

B.4.14 Ground Systems

Design assumptions

- Ground system is based on a mission specific implementation of the standard JPL mission operations and ground data systems
 - Assuming JPL full project implementation (Mothership and constellations)
 - Enables significant sharing of Mission System components and processes
 - Enables common solution across the project versus unnecessary unique processes for the constellations, there will be unique features but on the whole everything should look and feel similar
 - Co-location of elements sharing development processes and operations
 - Mothership handles all communications to/from Earth, relays to/from the constellation S/C
 - Project has planning tools for scheduling relay links and radio occultation passes automatically between flight elements

Design

- Ground Based Space Communications Network
 - DSN 34 m beam waveguide (BWG) subnet used for all communications to the Mothership, other stations can be brought in to augment performance during critical activities

The cost in \$M FY2025 is shown in Table B-67. The cost does not include the Areostationary constellations.

Table B-67. Ground system cost.

Option	07 MOS Dev	09A GDS Dev	09B SDS Dev	Total Dev	07 MOS Ops	90A GDS Ops	09B SDS Ops	Total Ops	Total Project
1–Mothership only	33.1	34.3	5.2	72.7	62.7	10.5	14.9	88.2	160.9
2–Mothership + constellations	48.9	44.8	8.8	102.5	117.0	12.5	25.2	154.7	257.3
3–NF class Mothership only	25.2	20.5	2.1	47.8	62.0	9.2	6.0	77.2	124.9
4–NF class Mothership + constellations	39.0	35.6	6.5	81.1	117.0	12.5	18.6	149.1	229.2

Cost considerations

- Cost Drivers
 - All costs assume JPL is building the spacecraft and Mission System. The GDS, GDS support engineers, is provided early to support FSW development and used throughout to test the flight system and prepare for flight operations
 - This includes the SmallSat constellations
 - Mothership + constellation estimates include uppers for developing the planning tools necessary to coordinate across the different elements for the relay communications and radio occultation experiments
- Potential Cost Savings
 - All elements being vendor built and operated may be less expensive than a JPL only built and operated concept, however JPL will likely need to build and operate the cross coordination planning tools, in addition to performing insight/oversight of each of the flight element mission systems.

- Potential Cost Uppers
 - Vendor built SmallSats with JPL operations will likely increase system costs, vendors typically develop and test with their own systems. JPL GDS will need to be adapted, likely more than typically to work with unique smallsats, plus the Ops team is usually drawn from the FS developers, in this case JPL will need to train a whole new crew during Phase D.
 - Vendor built/operated SmallSats will need likely require different interfaces for the coordination planning tools

B.4.15 Software

Design assumptions

- FSW infrastructure: complex
 - Similar to MSL
- Fault Behavior and autonomy: complex
 - Similar to MSL cross strapping
- Mechanisms
 - 2 simple
 - Solar array deployment
 - Daughtership deployment
 - 1 medium
 - Telecom boom deployment
 - 1 complex
 - SAR antenna and boom deployment
- GNC features
 - Spacecraft Attitude control: High
 - May have interaction with the deployed SAR antenna
 - Articulated pointing
 - 1 simple: Solar arrays
 - 3 medium: Gimbal for thrusters, comm antenna, SAR articulation
 - Thrust vector control – medium, assume based on use of SEP
- CDH features
 - Data management complexity – High
 - Due to Mothership science data + acting as a data relay for daughterships
 - Nonvolatile memory – yes
 - Dual string flight computers
- Engineering subsystems
 - Thermal control – moderate
 - Power control – moderate
 - Although there is a risk this could be more expensive as complex for a SEP spacecraft
 - Telecom – Difficult
 - Due to Mothership science + acting as a data relay for daughterships
- Payload accommodation
 - Simple instruments – 2
 - Model the 2 distinct types of daughterships as instruments while connected to the Mothership
 - Medium instruments – 8

- The instruments on the Mothership
- Assume control of mechanisms on the LIDAR and sounder handled by the instruments
 - Would be a cost upper to have Mothership software control this
- Assume Mothership software controls the articulation of the SAR
- Implementation assumptions
 - In house, high experience, fully co-located
 - 2 or more partners on instruments, international partners on the instruments
- Heritage assumptions
 - Inheritance with minor mods: CDH
 - Inheritance with major mods: GNC, Engineering Applications, System Services
 - None to low inheritance: Payload

Design

- Assume software heritage base of FCPL core FSW
 - Used on prior SEP mission (Psyche) and intended for redundant avionics
- ACS Features
 - Solar electric propulsion (SEP)
 - Articulations:
 - Solar Arrays, SAR
 - Gimbals
 - Thrusters (for SEP), Comms antenna
 - Deployment of the SAR boom and antenna (complex deploy)
 - Deployment of the Comms antenna boom (simpler deploy)
- CDS Features
 - Redundant avionics/flight computers
 - Data handling: Instrument data + comms relay from daughterships
- Engineering Subsystems
 - Power: More complexity to handle SEP
 - Telecom:
 - Direct to Earth
 - Provide relay for daughtership
- Payload Accommodation
 - Mothership instruments
 - P-band radar
 - Visible camera
 - Thermal IR limb radiometer
 - Wind LIDAR (has a gimbal)
 - Sub-mm sounder (has a built in mechanism that moves)
 - Near IR Spectrometer
 - Wind Doppler interferometer
 - FUV/MUV spectrometer
- Daughtership interfaces (treated as instruments)
 - 5 physical daughterships
 - But assume there are only 2 distinct types of interfaces
 - Polar daughtership interface

- Elliptical daughtership interface

Design rationale

- Core FSW inherited from Psyche is the closest fit
 - Both were SEP missions with similar levels of redundant hardware
 - Can leverage the FCPL core flight software used on Psyche and Europa

Cost

- Option 1 (see Table B-68)
 - NRE: \$47.9M
 - RE: \$2.5M
 - Total: \$50.5M
- Option 3 (see Table B-69)
 - NRE: \$37.7M
 - RE: \$2.0M
 - Total: \$39.7M
- Changes from option 1 to option 3
 - No need for a SAR deployable antenna, boom, or its articulation
 - Removed 1 complex mechanism
 - Removed 1 medium articulation
 - Changed ACS complexity assumption from high to medium
 - Only 4 remaining instruments

Potential cost uppers

- Software heritage assumptions are a risk
- Heritage assumptions could be overstated
- Also the software for power may be underestimated if SEP complexity is more than anticipated

Table B-68. Software cost for option 1.

WBS	Title	Phase A	Cost (\$M)			Total \$M
			PMSR-PDR Phase B	PDR-ARR Phase C	ARR-Launch Phase D	
06.12.01	Flight Software Management	\$0.2	\$0.9	\$2.6	\$1.3	\$5.1
06.12.02	Fit S/W System Engineering	\$0.1	\$1.0	\$4.5	\$1.1	\$6.7
06.12.03	C&DH	\$-	\$0.2	\$3.6	\$0.5	\$4.3
06.12.04	GN&C FSW	\$-	\$-	\$3.4	\$0.8	\$4.2
06.12.05	Engineering Applications FSW	\$-	\$-	\$3.0	\$0.5	\$3.6
06.12.06	Payload Accommodation FSW	\$-	\$-	\$4.1	\$1.2	\$5.3
06.12.07	System Services	\$-	\$-	\$1.1	\$0.4	\$1.5
06.12.08	Fit S/W Development Testbed	\$-	\$-	\$1.8	\$0.3	\$2.1
06.12.09	Fit S/W-Integration and Test	\$-	\$-	\$10.8	\$2.8	\$13.6
Total Cost of Labor		\$0.4	\$2.2	\$34.9	\$8.9	\$46.4
06.12.01	Development Infrastructure Procurements	\$0.0	\$0.1	\$1.3	\$0.3	\$1.7
06.12.01	Travel	\$-	\$-	\$-	\$-	\$-
06.12.01	Development Infrastructure Support	\$-	\$0.4	\$0.9	\$1.0	\$2.3
Total Cost (including Procurements, etc.)		\$0.4	\$2.6	\$37.2	\$10.3	\$50.5

Table B-69. Software cost for option 3.

WBS	Title	Phase A	Cost (\$M)			Total \$M
			PMSR-PDR Phase B	PDR-ARR Phase C	ARR-Launch Phase D	
06.12.01	Flight Software Management	\$0.2	\$0.9	\$1.6	\$1.2	\$4.0
06.12.02	Fit S/W System Engineering	\$0.2	\$1.2	\$2.9	\$1.1	\$5.3
06.12.03	C&DH	\$-	\$0.2	\$3.4	\$0.7	\$4.3
06.12.04	GN&C FSW	\$-	\$-	\$2.2	\$1.0	\$3.2
06.12.05	Engineering Applications FSW	\$-	\$-	\$2.4	\$0.5	\$2.9
06.12.06	Payload Accommodation FSW	\$-	\$-	\$1.8	\$1.1	\$2.9
06.12.07	System Services	\$-	\$-	\$0.9	\$0.6	\$1.5
06.12.08	Fit S/W Development Testbed	\$-	\$-	\$1.2	\$0.4	\$1.6
06.12.09	Fit S/W-Integration and Test	\$-	\$-	\$7.3	\$3.3	\$10.6
Total Cost of Labor		\$0.4	\$2.2	\$23.9	\$9.9	\$36.3
06.12.01	Development Infrastructure Procurements	\$0.0	\$0.1	\$0.9	\$0.4	\$1.4
06.12.01	Travel	\$-	\$-	\$-	\$-	\$-
06.12.01	Development Infrastructure Support	\$-	\$0.3	\$0.8	\$0.8	\$2.0
Total Cost (including Procurements, etc.)		\$0.4	\$2.7	\$25.6	\$11.0	\$39.7

B.4.16 Planetary Protection

Mission category and justification: This is a Category III mission according to the official NASA Planetary Protection guidelines, “NPR 8020.12D Planetary Protection Provisions for Robotic Extraterrestrial Missions.” Category III includes flyby and/or orbiter missions to targets of significant interest relative to the process of chemical evolution and/or the origin of life or for which scientific opinion provides a significant chance of contamination, which would jeopardize a future biological experiment or exploration program(s).

Note: The Planetary Protection implementation is the same for all options.

Requirements

- Documentation:
 - Request for Planetary Protection Mission Categorization
 - Planetary Protection Plan
 - Subsidiary Plans:
 - Biological Contamination Analysis Plan
 - Microbiological Assay Plan
 - Microbial Reduction Plan
 - Planetary Protection Implementation Plan
 - Pre-Launch Planetary Protection Report
 - Post-Launch Planetary Protection Report
 - Extended Mission Planetary Protection Report (only required for extended mission)
 - End-of-Mission Planetary Protection Report
- Periodic formal and informal reviews with the NASA Planetary Protection Officer (PPO), including:
 - Project Planetary Planning Review (PPO Option)
 - Pre-Launch Planetary Protection Review
 - Launch Readiness Review
 - Others as negotiated with the PP Officer, typically coinciding with major project reviews

- Impact Avoidance:
 - Probability of impact of Mars by the launch vehicle (or any stage thereof) shall not exceed 10^{-4}
 - The probability of entry into the Martian atmosphere and impact on the surface of Mars shall not exceed the following levels for the specified time periods:
 - 10^{-2} for the first 20 years from date of launch
 - 5×10^{-2} for the period of 20 to 50 years from date of launch
 - If probability of Mars impact exceeds requirement then:
 - Total (all surfaces, including mated, and in the bulk of non-metals) bioburden at launch of all hardware 5×10^5 viable spores
 - Organic Inventory: An itemized list of bulk organic materials and masses used in launched hardware
 - Organic Archive: A stored collection of 50 g samples of organic bulk materials of which 25 kg or more is used in launched hardware
- Spacecraft assembled in Class 100,000 / ISO Class 8 (or better) clean facilities, with appropriate controls and procedures
- Biological Contamination Control:
 - Bioassays to establish the microbial bioburden levels
 - Independent verification bioassays by NASA Planetary Protection Officer

Implementing procedures

- Preparation of the required PP documentation
- Periodic formal and informal reviews with the NASA PPO
- Trajectory biasing
- Analyses:
 - Probability of impact of Mars by the launch vehicle
 - Probability of impact of Mars by the spacecraft during the prime mission
 - Spacecraft microbial burden estimation at launch
 - Entry heating and break-up analysis (also known as the Burn & Break-up or B&B analysis)
- Spacecraft assembly performed in Class 100,000 / ISO Class 8 (or better) clean facilities, with appropriate controls and procedures
- Microbial burden Reduction:
 - Alcohol-wipe cleaning
 - Precision cleaning
 - Heat microbial reduction (HMR)
 - Vapor H_2O_2 microbial reduction (VHPMR)

Subsystem design requirements

- Orbital lifetime approach:
 - Trajectory must be biased to meet probability of impact requirements
- Biological cleanliness approach:
 - Launch vehicle fairing, PAF, upper stage must be cleaned/microbially reduced to 1000 spores/m²
 - All hardware must be compatible with damp-swab sampling
 - All hardware must be compatible with alcohol-wipe cleaning
 - Use of HMR &/or VHPMR for hardware items with large surface area and not demonstrated to be sterilized on entry

Cost rationale and assumptions

- Flight system will not meet orbital lifetime/probability of impact requirement (due to low periapsis)

- Entry heating and break-up analysis will demonstrate that most of the flight system hardware will be sterilized on entry
- Includes the following activities required for a Mars Orbiter mission not meeting orbital lifetime:
 - Includes all PP documentation and review support:
 - Includes required analyses
 - Bioassay sampling of:
 - All flight system hardware surfaces that will not sterilize on entry, or are a recontamination risk to hardware that will not sterilize on entry
 - Bulk bioassay sample of key/driving materials that will not sterilize on entry
 - Assembly facilities and ground support equipment that are a recontamination risk
 - Launch vehicle hardware
 - Genomic inventory sampling will not be required
- Limited microbial reduction procedures required for hardware, as the majority of hardware should be sterilized on entry. If required, the cost of performing the microbial reduction procedures to be carried by hardware subsystems.
- The costs of biobarriers/bioshields and HEPA filters, if required, to be carried by hardware subsystems.
 - Some of the development costs may be covered under technology development

Cost for option 1 & 3 are shown in Table B-70.

Table B-70. Planetary protection cost for option 1 & 3.

	FTE (yrs)	Cost (FY25 M\$)
Development Phase	9.01	3.76
Operations Phase	0.37	0.16
Total	9.38	3.92

Risks

- The Mothership spacecraft may need to share the 5×10^5 total spores with the Polar and Elliptical spacecraft rather than getting its own allocation, therefore requiring cleaning and microbial reduction procedures and additional bioassay sampling not currently planned (~\$2-5 M cost to project)
- Entry heating and break-up analysis may indicate that no flight system hardware will be sterilized on entry, therefore requiring cleaning and microbial reduction procedures and additional bioassay sampling not currently planned (~\$2-5 M cost to project)
- Genomic inventory sampling may be required (~\$1-3 M cost to project)

B.4.17 SVIT

Option 1 cost for V&V is \$6.5M, see Table B-71.

Table B-71. Option 1 cost for V&V.

Project Verification & Validation Cost By Phase								
Phase	A	B	C1	C2	C3	D1	D2	Total
Duration	15 mo.	15 mo.	14 mo.	14 mo.	13 mo.	19 mo.	4 mo.	94 mo.
Total	\$0.0 K	\$286.5 K	\$541.2 K	\$1574.1 K	\$1461.7 K	\$2136.3 K	\$449.7 K	\$6449.5 K
Lead	\$0.0 K	\$286.5 K	\$541.2 K	\$891.4 K	\$827.7 K	\$1209.7 K	\$254.7 K	\$4011.1 K
Deputy	\$0.0 K	\$0.0 K	\$0.0 K	\$682.8 K	\$634.0 K	\$926.6 K	\$195.1 K	\$2438.4 K

Option 2 cost for V&V is \$5.8M, see Table B-72.

Table B-72. Option 2 cost for V&V.

Project Verification & Validation Cost By Phase								
Phase	A	B	C1	C2	C3	D1	D2	Total
Duration	15 mo.	15 mo.	14 mo.	14 mo.	13 mo.	19 mo.	4 mo.	94 mo.
Total	\$0.0 K	\$254.3 K	\$480.4 K	\$1406.9 K	\$1306.4 K	\$1909.4 K	\$402.0 K	\$5759.4 K
Lead	\$0.0 K	\$254.3 K	\$480.4 K	\$791.3 K	\$734.7 K	\$1073.9 K	\$226.1 K	\$3560.7 K
Deputy	\$0.0 K	\$0.0 K	\$0.0 K	\$615.6 K	\$571.7 K	\$835.5 K	\$175.9 K	\$2198.7 K

Option 3 cost for V&V is \$2.2M, see Table B-73.

Table B-73. Option 3 cost for V&V.

Project Verification & Validation Cost By Phase								
Phase	A	B	C1	C2	C3	D1	D2	Total
Duration	12 mo.	12 mo.	11 mo.	6 mo.	5 mo.	14 mo.	4 mo.	64 mo.
Total	\$0.0 K	\$132.6 K	\$247.6 K	\$374.8 K	\$312.3 K	\$874.5 K	\$249.9 K	\$2191.7 K
Lead	\$0.0 K	\$132.6 K	\$247.6 K	\$212.2 K	\$176.9 K	\$495.2 K	\$141.5 K	\$1406.0 K
Deputy	\$0.0 K	\$0.0 K	\$0.0 K	\$162.6 K	\$135.5 K	\$379.3 K	\$108.4 K	\$785.7 K

Option 4 cost for V&V is \$4.0M, see Table B-74.

Table B-74. Option 4 cost for V&V.

Project Verification & Validation Cost By Phase								
Phase	A	B	C1	C2	C3	D1	D2	Total
Duration	12 mo.	12 mo.	11 mo.	6 mo.	5 mo.	19 mo.	4 mo.	69 mo.
Total	\$0.0 K	\$211.9 K	\$395.6 K	\$603.0 K	\$502.5 K	\$1909.4 K	\$402.0 K	\$4024.3 K
Lead	\$0.0 K	\$211.9 K	\$395.6 K	\$339.1 K	\$282.6 K	\$1073.9 K	\$226.1 K	\$2529.2 K
Deputy	\$0.0 K	\$0.0 K	\$0.0 K	\$263.8 K	\$219.9 K	\$835.5 K	\$175.9 K	\$1495.1 K

System testbed summary

- The MOSAIC project will develop 2 test beds in order to facilitate the V&V program.
 - Mission System Test Bed
 - Dual string, high-fidelity, used for mission scenario, fault protection, cross-cutting, special focus on aligning the two spacecraft
 - Flight Software Test Bed
 - Single string, software development and regression testing

System testbed cost

- Option 1: \$12.5M
- Option 2: \$15.0M
- Option 3: \$9.8M
- Option 4: \$9.9M

System I&T summary

- The MOSAIC system will be assembled, and tested at JPL. Launched from KSC. Instrument deliveries are assumed as JPL deliverables.
- Key Assumptions
 - JPL build
 - JPL environmental test lab
 - All MGSE and EGSE are delivered to ATLO by sub-systems

System I&T cost

- Option 1: \$40.5M
- Option 2: \$36.5M
- Option 3: \$28.9M
- Option 4: \$31.0M

B.4.18 Cost

Disclaimer: The costs presented in this Team X design report are ROM estimates, not point estimates or cost commitments. It is likely that each estimate could range from as much as 20% percent higher to 10% lower. The costs presented are based on Pre-Phase A design information, which is subject to change.

Cost requirements

- Fiscal Year Dollars: 2025
- Cost Target: Options 1, 2, 4: No cap (Flagship-class); Option 3: \$1.1B Phase A-D (New Frontiers class)
- The study examined 2 technical options, each with 2 cost accountings, for a total of 4 options:
 - **Option 1** carries 8 instruments on the Mothership, and only the Mothership is costed
 - It addresses ambitious science, and does not fit in a New Frontiers cost bin
 - **Option 2** is the same technical design as Option 1, but the cost accounting includes a full project-level roll-up of all of the elements in the constellation
 - **Option 3** carries 4 instruments on the Mothership, and only the Mothership is costed
 - It is slimmed-down to fit in a New Frontiers cost bin
 - **Option 4** is the same technical design as Option 3, but the cost accounting includes a full project-level roll-up of all of the elements in the constellation
 - The full project is Flagship-class

Cost assumptions

- Fiscal Year: FY25
- Mission Class/Cost Category:
 - Option 1: A/Flagship
 - Option 2: A/Flagship
 - Option 3: B/Large (New Frontiers)
 - Option 4: A/Flagship
- Both Pre-Decadal and New Frontiers cost reserves presented for each of the 4 options:
 - Pre-Decadal guidelines:
 - Phases A-D Reserves 50% - Not calculated on LV and Tracking costs
 - Phases E-F Reserves 25% - Not calculated on LV and Tracking costs
 - New Frontiers guidelines
 - Phases A-D Reserves 30% - Not calculated on LV and Tracking costs
 - Phases E-F Reserves 15% - Not calculated on LV and Tracking costs
- Management and Systems Engineering
 - Project: For Options 2 & 4 only, with all the elements combined, considering the 10+ elements that make up this mission, we consulted with Section 312 management and did a grass roots estimate in addition to the model estimates and adjusted the level of effort (FTEs) for the following WBS elements: PSE, PSSE, EEIS, Configuration Management and Risk Management.
 - Flight System/Science/Planetary Protection/MDNav/SVIT: For Options 2 & 4 only, the estimates from the Team Xc study were entered individually into the Mothership workbook. They included Polar Orbit, Elliptical and Areostationary Mothership.
 - The estimates for the SmallSats within the Areostationary Mothership were passed through by the MOSAIC study team.
 - MOS/GDS: For Options 2 & 4 only, the estimates were entered from the Team Xc study for only the Areostationary elements. The estimates for Polar Orbit and Elliptical were included in the total Mothership cost.
- No contributed items were considered.

The total cost for options 1-4 are shown in Tables B-75 to B-78.

Table B-75. Total cost for option 1.

(Reserves: A–D 50% E/F 25%)				
Cost Summary (FY025 \$M)	Generate ProPricer Input	Team X Estimate		
		CBE	Res.	PBE
Project Cost		\$1779.8	46%	\$2601.4
Launch Vehicle		\$0.0		\$0.0
Project Cost (w/o LV)		\$1779.8	46%	\$2601.4
Development Cost		\$1531.2	50%	\$2296.4
Phase A		\$15.3	50%	\$23.0
Phase B		\$137.8	50%	\$206.7
Phase C/D		\$1378.1	50%	\$2066.8
Operations Cost		\$248.6	23%	\$305.0

(Reserves: A–D 30% E/F 15%)				
Cost Summary (FY025 \$M)	Generate ProPricer Input	Team X Estimate		
		CBE	Res.	PBE
Project Cost		\$1779.8	28%	\$2272.8
Launch Vehicle		\$0.0		\$0.0
Project Cost (w/o LV)		\$1779.8	28%	\$2272.8
Development Cost		\$1531.2	30%	\$1990.3
Phase A		\$15.3	30%	\$19.9
Phase B		\$137.8	30%	\$179.1
Phase C/D		\$1378.1	30%	\$1791.3
Operations Cost		\$248.6	14%	\$282.4

Table B-76. Total cost for option 2.

(Reserves: A–D 50% E/F 25%)				
Cost Summary (FY025 \$M)	Generate ProPricer Input	Team X Estimate		
		CBE	Res.	PBE
Project Cost		\$2693.1	46%	\$3939.1
Launch Vehicle		\$0.0		\$0.0
Project Cost (w/o LV)		\$2693.1	46%	\$3939.1
Development Cost		\$2315.5	50%	\$3472.9
Phase A		\$23.2	50%	\$34.7
Phase B		\$208.4	50%	\$312.6
Phase C/D		\$2084.0	50%	\$3125.6
Operations Cost		\$377.5	23%	\$466.2

(Reserves: A–D 30% E/F 15%)				
Cost Summary (FY025 \$M)	Generate ProPricer Input	Team X Estimate		
		CBE	Res.	PBE
Project Cost		\$2693.1	28%	\$3440.7
Launch Vehicle		\$0.0		\$0.0
Project Cost (w/o LV)		\$2693.1	28%	\$3440.7
Development Cost		\$2315.5	30%	\$3010.0
Phase A		\$23.2	30%	\$30.1
Phase B		\$208.4	30%	\$270.9
Phase C/D		\$2084.0	30%	\$2709.0
Operations Cost		\$377.5	14%	\$430.7

Table B-77. Total cost for option 3.

(Reserves: A–D 50% E/F 25%)				
Cost Summary (FY025 \$M)	Generate ProPricer Input	Team X Estimate		
		CBE	Res.	PBE
Project Cost		\$967.4	45%	\$1401.4
Launch Vehicle		\$0.0		\$0.0
Project Cost (w/o LV)		\$967.4	45%	\$1401.4
Development Cost		\$793.0	50%	\$1189.2
Phase A		\$7.9	50%	\$11.9
Phase B		\$71.4	50%	\$107.0
Phase C/D		\$713.7	50%	\$1070.2
Operations Cost		\$174.4	22%	\$212.2

(Reserves: A–D 30% E/F 15%)				
Cost Summary (FY025 \$M)	Generate ProPricer Input	Team X Estimate		
		CBE	Res.	PBE
Project Cost		\$967.6	27%	\$1228.0
Launch Vehicle		\$0.0		\$0.0
Project Cost (w/o LV)		\$967.6	27%	\$1228.0
Development Cost		\$793.2	30%	\$1030.9
Phase A		\$7.9	30%	\$10.3
Phase B		\$71.4	30%	\$92.8
Phase C/D		\$713.9	30%	\$927.8
Operations Cost		\$174.4	13%	\$197.1

Table B-78. Total cost for option 4.

(Reserves: A–D 50% E/F 25%)				
Cost Summary (FY025 \$M)	Generate ProPricer Input	Team X Estimate		
		CBE	Res.	PBE
Project Cost		\$1920.3	45%	\$2792.3
Launch Vehicle		\$0.0		\$0.0
Project Cost (w/o LV)		\$1920.3	45%	\$2792.3
Development Cost		\$1592.3	50%	\$2388.1
Phase A		\$15.9	50%	\$23.9
Phase B		\$143.3	50%	\$214.9
Phase C/D		\$1433.1	50%	\$2149.3
Operations Cost		\$328.0	23%	\$404.2

(Reserves: A–D 30% E/F 15%)				
Cost Summary (FY025 \$M)	Generate ProPricer Input	Team X Estimate		
		CBE	Res.	PBE
Project Cost		\$1920.3	27%	\$2443.5
Launch Vehicle		\$0.0		\$0.0
Project Cost (w/o LV)		\$1920.3	27%	\$2443.5
Development Cost		\$1592.3	30%	\$2069.8
Phase A		\$15.9	30%	\$20.7
Phase B		\$143.3	30%	\$186.3
Phase C/D		\$1433.1	30%	\$1862.8
Operations Cost		\$328.0	14%	\$373.7

Cost

- Option 1
 - Phase A-D
 - 50% Reserves: \$2.3B (see Table B-79)
 - 30% Reserves: \$2.0B (see Table B-80)
 - Phase E-F
 - 25% Reserves: \$305M (see Table B-81)
 - 15% Reserves: \$282M (see Table B-82)
- Option 2
 - Phase A-D
 - 50% Reserves: \$3.47B (see Table B-83)
 - 30% Reserves: \$3.0B (see Table B-84)
 - Phase E-F
 - 25% Reserves: \$466M (see Table B-85)
 - 15% Reserves: \$430M (see Table B-86)
- Option 3
 - Phase A-D
 - 50% Reserves: \$1.2B (see Table B-87)
 - 30% Reserves: \$1.0B (see Table B-88)
 - Phase E-F
 - 25% Reserves: \$212M (see Table B-89)
 - 15% Reserves: \$197M (see Table B-90)
- Option 4
 - Phase A-D
 - 50% Reserves: \$2.4B (see Table B-91)
 - 30% Reserves: \$2.0B (see Table B-92)
 - Phase E-F
 - 25% Reserves: \$404M (see Table B-93)
 - 15% Reserves: \$374M (see Table B-94)

Table B-79. Cost A–D for option 1 (50% reserve).

Development Cost (Phases A - D)	\$1608.7 M	\$687.8 M	\$2296.4 M
01.0 Project Management	\$41.5 M		\$41.5 M
1.01 Project Management	\$17.1 M		\$17.1 M
1.02 Business Management	\$20.5 M		\$20.5 M
1.04 Project Reviews	\$3.5 M		\$3.5 M
1.06 Launch Approval	\$0.4 M		\$0.4 M
02.0 Project Systems Engineering	\$51.3 M	\$3.2 M	\$54.5 M
2.01 Project Systems Engineering	\$13.5 M		\$13.5 M
2.02 Project SW Systems Engineering	\$7.6 M		\$7.6 M
2.03 EEIS	\$0.9 M		\$0.9 M
2.04 Information System Management	\$7.9 M		\$7.9 M
2.05 Configuration Management	\$6.3 M		\$6.3 M
2.06 Planetary Protection	\$1.5 M	\$2.3 M	\$3.8 M
Mothership	\$1.5 M	\$2.3 M	\$3.8 M
2.07 Contamination Control	\$4.1 M	\$0.9 M	\$5.0 M
2.09 Launch System Engineering	\$2.4 M		\$2.4 M
2.10 Project V&V	\$6.4 M		\$6.4 M
2.11 Risk Management	\$0.7 M		\$0.7 M
03.0 Mission Assurance	\$46.5 M	\$19.9 M	\$66.3 M
04.0 Science	\$68.4 M		\$68.4 M
04.01, 04.02, & 04.03 Science Teams	\$68.4 M		\$68.4 M
05.0 Payload System	\$293.0 M	\$196.0 M	\$489.1 M
5.01 Payload Management	\$12.7 M		\$12.7 M
5.02 Payload Engineering	\$9.6 M		\$9.6 M
Element 01	\$270.7 M	\$196.0 M	\$466.7 M
P-Band SAR/Sounder Radar (SMAP)	\$85.4 M	\$61.9 M	\$147.3 M
Visible Imager (MARCI)	\$3.4 M	\$2.5 M	\$5.9 M
Limb Radiometer (Mars Climate Sounder)	\$20.0 M	\$14.5 M	\$34.5 M
Wind LIDAR (MARLI)	\$45.0 M	\$32.6 M	\$77.5 M
Sub-mm Sounder (Mars Compass)	\$33.8 M	\$24.5 M	\$58.3 M
Near IR Spect (Thoth Argus)	\$1.6 M	\$1.2 M	\$2.8 M
Wind Doppler Interferometer (MIGHTI)	\$40.5 M	\$29.4 M	\$69.9 M
FUV/MUV Spect (IUVS-MAVEN)	\$40.9 M	\$29.6 M	\$70.5 M

	\$431.0 M	\$234.6 M	\$665.6 M
06.0 Flight System			
6.01 Flight System Management	\$7.8 M		\$7.8 M
6.02 Flight System Systems Engineering	\$58.5 M		\$58.5 M
6.03 Product Assurance (included in 3.0)			\$0.0 M
Mothership	\$355.3 M	\$231.5 M	\$586.8 M
6.04 Power	\$22.4 M	\$61.8 M	\$84.2 M
6.05 C&DH	\$46.7 M	\$38.2 M	\$84.9 M
6.06 Telecom	\$42.0 M	\$31.3 M	\$73.4 M
6.07 Structures (includes Mech. I&T)	\$73.5 M	\$18.3 M	\$91.8 M
6.08 Thermal	\$5.1 M	\$6.2 M	\$11.3 M
6.09 Propulsion	\$67.8 M	\$41.1 M	\$108.9 M
6.10 ACS	\$25.3 M	\$18.3 M	\$43.6 M
6.11 Harness	\$15.3 M	\$12.8 M	\$28.1 M
6.12 S/C Software	\$47.9 M	\$2.5 M	\$50.5 M
6.13 Materials and Processes	\$9.3 M	\$1.0 M	\$10.4 M
6.14 Spacecraft Testbeds	\$9.3 M	\$3.1 M	\$12.5 M
07.0 Mission Operations Preparation	\$36.4 M		\$36.4 M
7.0 MOS Teams	\$33.1 M		\$33.1 M
7.03 Tracking (Launch Ops.)	\$0.7 M		\$0.7 M
7.06 Navigation Operations Team	\$2.6 M		\$2.6 M
7.07.03 Mission Planning Team	\$0.0 M		\$0.0 M
09.0 Ground Data Systems	\$39.5 M		\$39.5 M
9.0A Ground Data System	\$34.3 M		\$34.3 M
9.0B Science Data System Development	\$4.2 M		\$4.2 M
9A.03.07 Navigation H/W & S/W Development	\$1.0 M		\$1.0 M
10.0 ATLO	\$35.7 M	\$4.8 M	\$40.5 M
11.0 Education and Public Outreach	\$0.0 M	\$0.0 M	\$0.0 M
12.0 Mission and Navigation Design	\$29.3 M		\$29.3 M
12.01 Mission Design	\$3.2 M		\$3.2 M
12.02 Mission Analysis	\$6.8 M		\$6.8 M
12.03 Mission Engineering	\$7.5 M		\$7.5 M
12.04 Navigation Design	\$11.7 M		\$11.7 M
Development Reserves	\$536.0 M	\$229.3 M	\$765.2 M

Table B-80. Cost A–D for option 1 (30% reserve).

Development Cost (Phases A - D)	\$1394.3 M	\$596.1 M	\$1990.3 M
01.0 Project Management	\$41.5 M		\$41.5 M
1.01 Project Management	\$17.1 M		\$17.1 M
1.02 Business Management	\$20.5 M		\$20.5 M
1.04 Project Reviews	\$3.5 M		\$3.5 M
1.06 Launch Approval	\$0.4 M		\$0.4 M
02.0 Project Systems Engineering	\$51.3 M	\$3.2 M	\$54.5 M
2.01 Project Systems Engineering	\$13.5 M		\$13.5 M
2.02 Project SW Systems Engineering	\$7.6 M		\$7.6 M
2.03 EEIS	\$0.9 M		\$0.9 M
2.04 Information System Management	\$7.9 M		\$7.9 M
2.05 Configuration Management	\$6.3 M		\$6.3 M
2.06 Planetary Protection	\$1.5 M	\$2.3 M	\$3.8 M
Mothership	\$1.5 M	\$2.3 M	\$3.8 M
2.07 Contamination Control	\$4.1 M	\$0.9 M	\$5.0 M
2.09 Launch System Engineering	\$2.4 M		\$2.4 M
2.10 Project V&V	\$6.4 M		\$6.4 M
2.11 Risk Management	\$0.7 M		\$0.7 M
03.0 Mission Assurance	\$46.5 M	\$19.9 M	\$66.3 M
04.0 Science	\$68.4 M		\$68.4 M
04.01, 04.02, & 04.03 Science Teams	\$68.4 M		\$68.4 M
05.0 Payload System	\$293.0 M	\$196.0 M	\$489.1 M
5.01 Payload Management	\$12.7 M		\$12.7 M
5.02 Payload Engineering	\$9.6 M		\$9.6 M
Element 01	\$270.7 M	\$196.0 M	\$466.7 M
P-Band SAR/Sounder Radar (SMAP)	\$85.4 M	\$61.9 M	\$147.3 M
Visible Imager (MARCI)	\$3.4 M	\$2.5 M	\$5.9 M
Limb Radiometer (Mars Climate Sounder)	\$20.0 M	\$14.5 M	\$34.5 M
Wind LIDAR (MARLI)	\$45.0 M	\$32.6 M	\$77.5 M
Sub-mm Sounder (Mars Compass)	\$33.8 M	\$24.5 M	\$58.3 M
Near IR Spect (Thoth Argus)	\$1.6 M	\$1.2 M	\$2.8 M
Wind Doppler Interferometer (MIGHTI)	\$40.5 M	\$29.4 M	\$69.9 M
FUV/MUV Spect (IUVS-MAVEN)	\$40.9 M	\$29.6 M	\$70.5 M

	\$431.0 M	\$234.6 M	\$665.6 M
06.0 Flight System			
6.01 Flight System Management	\$7.8 M		\$7.8 M
6.02 Flight System Systems Engineering	\$58.5 M		\$58.5 M
6.03 Product Assurance (included in 3.0)			\$0.0 M
Mothership	\$355.3 M	\$231.5 M	\$586.8 M
6.04 Power	\$22.4 M	\$61.8 M	\$84.2 M
6.05 C&DH	\$46.7 M	\$38.2 M	\$84.9 M
6.06 Telecom	\$42.0 M	\$31.3 M	\$73.4 M
6.07 Structures (includes Mech. I&T)	\$73.5 M	\$18.3 M	\$91.8 M
6.08 Thermal	\$5.1 M	\$6.2 M	\$11.3 M
6.09 Propulsion	\$67.8 M	\$41.1 M	\$108.9 M
6.10 ACS	\$25.3 M	\$18.3 M	\$43.6 M
6.11 Harness	\$15.3 M	\$12.8 M	\$28.1 M
6.12 S/C Software	\$47.9 M	\$2.5 M	\$50.5 M
6.13 Materials and Processes	\$9.3 M	\$1.0 M	\$10.4 M
6.14 Spacecraft Testbeds	\$9.3 M	\$3.1 M	\$12.5 M
07.0 Mission Operations Preparation	\$36.4 M		\$36.4 M
7.0 MOS Teams	\$33.1 M		\$33.1 M
7.03 Tracking (Launch Ops.)	\$0.7 M		\$0.7 M
7.06 Navigation Operations Team	\$2.6 M		\$2.6 M
7.07.03 Mission Planning Team	\$0.0 M		\$0.0 M
09.0 Ground Data Systems	\$39.5 M		\$39.5 M
9.0A Ground Data System	\$34.3 M		\$34.3 M
9.0B Science Data System Development	\$4.2 M		\$4.2 M
9A.03.07 Navigation H/W & S/W Development	\$1.0 M		\$1.0 M
10.0 ATLO	\$35.7 M	\$4.8 M	\$40.5 M
11.0 Education and Public Outreach	\$0.0 M	\$0.0 M	\$0.0 M
12.0 Mission and Navigation Design	\$29.3 M		\$29.3 M
12.01 Mission Design	\$3.2 M		\$3.2 M
12.02 Mission Analysis	\$6.8 M		\$6.8 M
12.03 Mission Engineering	\$7.5 M		\$7.5 M
12.04 Navigation Design	\$11.7 M		\$11.7 M
Development Reserves	\$321.6 M	\$137.6 M	\$459.1 M

Table B-81. Cost E–F for option 1 (25% reserve).

Operations Cost (Phases E–F)	\$304.8M	\$0.2M	\$305.0M
01.0 Project Management	\$11.7M		\$11.7M
1.01 Project Management	\$6.8M		\$6.8M
1.02 Business Management	\$4.4M		\$4.4M
1.04 Project Reviews	\$0.4M		\$0.4M
1.06 Launch Approval	\$0.0M		\$0.0M
02.0 Project Systems Engineering	\$0.0M	\$0.1M	\$0.2M
2.06 Planetary Protection	\$0.0M	\$0.1M	\$0.2M
03.0 Mission Assurance	\$4.1M	\$0.0M	\$4.1M
04.0 Science	\$114.5M		\$114.5M
4.02 Science Team	\$114.5M		\$114.5M
06.0 Flight System	\$0.0M		\$0.0M
6.02 Flight System Systems Engineering	\$0.0M		\$0.0M
07.0 Mission Operations	\$95.4M		\$95.4M
7.0 MOS Teams	\$62.7M		\$62.7M
7.03 Tracking	\$23.0M		\$23.0M
7.06 Navigation Operations Team	\$9.2M		\$9.2M
7.07.03 Mission Planning Team	\$0.5M		\$0.5M
09.0 Ground Data Systems	\$22.7M		\$22.7M
9.0A GDS Teams	\$10.5M		\$10.5M
9.0B Science Data System Ops	\$12.0M		\$12.0M
9A.03.07 Navigation H/W and S/W Dev	\$0.2M		\$0.2M
11.0 Education and Public Outreach	\$0.0M	\$0.0M	\$0.0M
12.0 Mission and Navigation Design	\$0.0M		\$0.0M
12.01 Mission Design	\$0.0M		\$0.0M
12.02 Mission Analysis	\$0.0M		\$0.0M
12.04 Navigation Design	\$0.0M		\$0.0M
Operations Reserves	\$56.4M	\$0.0M	\$56.4M

Table B-82. Cost E–F for option 1 (15% reserve).

Operations Cost (Phases E–F)	\$282.3M	\$0.2M	\$282.4M
01.0 Project Management	\$11.7M		\$11.7M
1.01 Project Management	\$6.8M		\$6.8M
1.02 Business Management	\$4.4M		\$4.4M
1.04 Project Reviews	\$0.4M		\$0.4M
1.06 Launch Approval	\$0.0M		\$0.0M
02.0 Project Systems Engineering	\$0.0M	\$0.1M	\$0.2M
2.06 Planetary Protection	\$0.0M	\$0.1M	\$0.2M
03.0 Mission Assurance	\$4.1M	\$0.0M	\$4.1M
04.0 Science	\$114.5M		\$114.5M
4.02 Science Team	\$114.5M		\$114.5M
06.0 Flight System	\$0.0M		\$0.0M
6.02 Flight System Systems Engineering	\$0.0M		\$0.0M
07.0 Mission Operations	\$95.4M		\$95.4M
7.0 MOS Teams	\$62.7M		\$62.7M
7.03 Tracking	\$23.0M		\$23.0M
7.06 Navigation Operations Team	\$9.2M		\$9.2M
7.07.03 Mission Planning Team	\$0.5M		\$0.5M
09.0 Ground Data Systems	\$22.7M		\$22.7M
9.0A GDS Teams	\$10.5M		\$10.5M
9.0B Science Data System Ops	\$12.0M		\$12.0M
9A.03.07 Navigation H/W and S/W Dev	\$0.2M		\$0.2M
11.0 Education and Public Outreach	\$0.0M	\$0.0M	\$0.0M
12.0 Mission and Navigation Design	\$0.0M		\$0.0M
12.01 Mission Design	\$0.0M		\$0.0M
12.02 Mission Analysis	\$0.0M		\$0.0M
12.04 Navigation Design	\$0.0M		\$0.0M
Operations Reserves	\$33.8M	\$0.0M	\$33.8M

Table B-83. Cost A–D for option 2 (50% reserve).

Development Cost (Phases A - D)	\$2643.4 M	\$829.5 M	\$3472.9 M
01.0 Project Management	\$41.5 M		\$41.5 M
1.01 Project Management	\$17.1 M		\$17.1 M
1.02 Business Management	\$20.5 M		\$20.5 M
1.04 Project Reviews	\$3.5 M		\$3.5 M
1.06 Launch Approval	\$0.4 M		\$0.4 M
02.0 Project Systems Engineering	\$92.9 M	\$5.9 M	\$98.8 M
2.01 Project Systems Engineering	\$32.1 M		\$32.1 M
2.02 Project SW Systems Engineering	\$9.6 M		\$9.6 M
2.03 EEIS	\$7.8 M		\$7.8 M
2.04 Information System Management	\$7.9 M		\$7.9 M
2.05 Configuration Management	\$9.6 M		\$9.6 M
2.06 Planetary Protection	\$5.4 M	\$5.0 M	\$10.4 M
MotherShip	\$1.5 M	\$2.3 M	\$3.8 M
Polar	\$1.3 M	\$1.8 M	\$3.1 M
Elliptical	\$1.3 M	\$0.9 M	\$2.2 M
Areo Mothership + SmallSats	\$1.3 M		\$1.3 M
2.07 Contamination Control	\$4.1 M	\$0.9 M	\$5.0 M
2.09 Launch System Engineering	\$2.4 M		\$2.4 M
2.10 Project V&V	\$5.8 M		\$5.8 M
2.11 Risk Management	\$8.3 M		\$8.3 M
03.0 Mission Assurance	\$75.4 M	\$23.7 M	\$99.1 M
04.0 Science	\$80.7 M		\$80.7 M
05.0 Payload System	\$476.3 M	\$210.5 M	\$686.8 M
5.01 Payload Management	\$60.2 M		\$60.2 M
5.02 Payload Engineering	\$54.9 M		\$54.9 M
MotherShip	\$270.7 M	\$196.0 M	\$466.7 M
Polar	\$8.4 M	\$6.9 M	\$15.3 M
Elliptical	\$18.9 M	\$7.5 M	\$26.4 M
Areo Mothership	\$55.7 M	\$0.0 M	\$55.7 M
Areo SmallSats	\$7.6 M	\$0.0 M	\$7.6 M
06.0 Flight System	\$679.1 M	\$302.3 M	\$981.4 M
6.01 Flight System Management	\$22.3 M		\$22.3 M
6.01A Mothership	\$7.8 M		\$7.8 M
6.01B Polar	\$2.9 M		\$2.9 M
6.01C Elliptical	\$2.7 M		\$2.7 M
6.01D Areo Mothership + SmallSats	\$8.8 M		\$8.8 M
6.02 Flight System Systems Engineering	\$73.7 M		\$73.7 M
6.01A Mothership	\$59.7 M		\$59.7 M
6.01B Polar	\$2.9 M		\$2.9 M
6.01C Elliptical	\$2.6 M		\$2.6 M
6.01D Areo Mothership + SmallSats	\$8.6 M		\$8.6 M
MotherShip	\$355.3 M	\$231.5 M	\$586.8 M
6.04 Power	\$22.4 M	\$61.8 M	\$84.2 M
6.05 C&DH	\$46.7 M	\$38.2 M	\$84.9 M
6.06 Telecom	\$42.0 M	\$31.3 M	\$73.4 M
6.07 Structures (includes Mech. I&T)	\$73.5 M	\$18.3 M	\$91.8 M
6.08 Thermal	\$5.1 M	\$6.2 M	\$11.3 M
6.09 Propulsion	\$67.8 M	\$41.1 M	\$108.9 M
6.10 ACS	\$25.3 M	\$18.3 M	\$43.6 M
6.11 Harness	\$15.3 M	\$12.8 M	\$28.1 M
6.12 S/C Software	\$47.9 M	\$2.5 M	\$50.5 M
6.13 Materials and Processes	\$9.3 M	\$1.0 M	\$10.4 M
Polar	\$28.7 M		\$28.7 M
Elliptical	\$38.1 M	\$14.9 M	\$53.0 M
Areo Mothership	\$121.2 M	\$0.0 M	\$121.2 M
Areo SmallSats	\$28.6 M	\$22.9 M	\$51.5 M
6.14 Spacecraft Testbeds	\$11.3 M	\$3.8 M	\$15.0 M
07.0 Mission Operations Preparation	\$77.1 M		\$77.1 M
07A.0 Mothership + Polar + Elliptical	\$53.4 M		\$53.4 M
7A.0 MOS Teams	\$48.9 M		\$48.9 M
7A.03 Tracking (Launch Ops.)	\$0.7 M		\$0.7 M
7A.06 Navigation Operations Team	\$3.7 M		\$3.7 M
7A.07.03 Mission Planning Team	\$0.0 M		\$0.0 M
07B.0 Areo Mothership + SmallSats	\$23.7 M		\$23.7 M
09.0 Ground Data Systems	\$81.8 M		\$81.8 M
09A.0 Mothership + Polar + Elliptical	\$54.6 M		\$54.6 M
9.0A Ground Data System	\$44.8 M		\$44.8 M
9.0B Science Data System Development	\$8.8 M		\$8.8 M
9A.03.07 Navigation H/W & S/W Development	\$0.9 M		\$0.9 M
09B.0 Areo Mothership + SmallSats	\$27.2 M		\$27.2 M
10.0 ATLO	\$64.8 M	\$10.7 M	\$75.4 M
MotherShip	\$31.8 M	\$4.8 M	\$36.5 M
Polar	\$3.6 M	\$3.6 M	\$7.2 M
Elliptical	\$5.7 M	\$2.3 M	\$8.0 M
Areo Mothership + SmallSats	\$23.7 M	\$0.0 M	\$23.7 M
11.0 Education and Public Outreach	\$0.0 M	\$0.0 M	\$0.0 M
12.0 Mission and Navigation Design	\$92.9 M		\$92.9 M
12A.0 Mothership	\$38.1 M		\$38.1 M
12A.01 Mission Design	\$2.9 M		\$2.9 M
12A.02 Mission Analysis	\$9.9 M		\$9.9 M
12A.03 Mission Engineering	\$6.7 M		\$6.7 M
12A.04 Navigation Design	\$18.6 M		\$18.6 M
12B.0 Polar	\$15.2 M		\$15.2 M
12C.0 Elliptical	\$13.2 M		\$13.2 M
12D.0 Areo Mothership + SmallSats	\$26.4 M		\$26.4 M
Development Reserves	\$880.9 M	\$276.5 M	\$1157.4 M

Table B-84. Cost A–D for option 2 (25% reserve).

Development Cost (Phases A - D)	\$2291.0 M	\$718.9 M	\$3010.0 M
01.0 Project Management	\$41.5 M		\$41.5 M
1.01 Project Management	\$17.1 M		\$17.1 M
1.02 Business Management	\$20.5 M		\$20.5 M
1.04 Project Reviews	\$3.5 M		\$3.5 M
1.06 Launch Approval	\$0.4 M		\$0.4 M
02.0 Project Systems Engineering	\$92.9 M	\$5.9 M	\$98.8 M
2.01 Project Systems Engineering	\$32.1 M		\$32.1 M
2.02 Project SW Systems Engineering	\$9.6 M		\$9.6 M
2.03 EEIS	\$7.8 M		\$7.8 M
2.04 Information System Management	\$7.9 M		\$7.9 M
2.05 Configuration Management	\$9.6 M		\$9.6 M
2.06 Planetary Protection	\$5.4 M	\$5.0 M	\$10.4 M
MotherShip	\$1.5 M	\$2.3 M	\$3.8 M
Polar	\$1.3 M	\$1.8 M	\$3.1 M
Elliptical	\$1.3 M	\$0.9 M	\$2.2 M
Areo Mothership + SmallSats	\$1.3 M		\$1.3 M
2.07 Contamination Control	\$4.1 M	\$0.9 M	\$5.0 M
2.09 Launch System Engineering	\$2.4 M		\$2.4 M
2.10 Project V&V	\$5.8 M		\$5.8 M
2.11 Risk Management	\$8.3 M		\$8.3 M
03.0 Mission Assurance	\$75.4 M	\$23.7 M	\$99.1 M
04.0 Science	\$80.7 M		\$80.7 M
05.0 Payload System	\$476.3 M	\$210.5 M	\$686.8 M
5.01 Payload Management	\$60.2 M		\$60.2 M
5.02 Payload Engineering	\$54.9 M		\$54.9 M
MotherShip	\$270.7 M	\$196.0 M	\$466.7 M
Polar	\$8.4 M	\$6.9 M	\$15.3 M
Elliptical	\$18.9 M	\$7.5 M	\$26.4 M
Areo Mothership	\$55.7 M	\$0.0 M	\$55.7 M
Areo SmallSats	\$7.6 M	\$0.0 M	\$7.6 M
06.0 Flight System	\$679.1 M	\$302.3 M	\$981.4 M
6.01 Flight System Management	\$22.3 M		\$22.3 M
6.01A Mothership	\$7.8 M		\$7.8 M
6.01B Polar	\$2.9 M		\$2.9 M
6.01C Elliptical	\$2.7 M		\$2.7 M
6.01D Areo Mothership + SmallSats	\$8.8 M		\$8.8 M
6.02 Flight System Systems Engineering	\$73.7 M		\$73.7 M
6.01A Mothership	\$59.7 M		\$59.7 M
6.01B Polar	\$2.9 M		\$2.9 M
6.01C Elliptical	\$2.6 M		\$2.6 M
6.01D Areo Mothership + SmallSats	\$8.6 M		\$8.6 M
MotherShip	\$355.3 M	\$231.5 M	\$586.8 M
6.04 Power	\$22.4 M	\$61.8 M	\$84.2 M
6.05 C&DH	\$46.7 M	\$38.2 M	\$84.9 M
6.06 Telecom	\$42.0 M	\$31.3 M	\$73.4 M
6.07 Structures (includes Mech. I&T)	\$73.5 M	\$18.3 M	\$91.8 M
6.08 Thermal	\$5.1 M	\$6.2 M	\$11.3 M
6.09 Propulsion	\$67.8 M	\$41.1 M	\$108.9 M
6.10 ACS	\$25.3 M	\$18.3 M	\$43.6 M
6.11 Harness	\$15.3 M	\$12.8 M	\$28.1 M
6.12 S/C Software	\$47.9 M	\$2.5 M	\$50.5 M
6.13 Materials and Processes	\$9.3 M	\$1.0 M	\$10.4 M
Polar	\$28.7 M	\$29.2 M	\$57.9 M
Elliptical	\$38.1 M	\$14.9 M	\$53.0 M
Areo Mothership	\$121.2 M	\$0.0 M	\$121.2 M
Areo SmallSats	\$28.6 M	\$22.9 M	\$51.5 M
6.14 Spacecraft Testbeds	\$11.3 M	\$3.8 M	\$15.0 M
07.0 Mission Operations Preparation	\$77.1 M		\$77.1 M
07A.0 Mothership + Polar + Elliptical	\$53.4 M		\$53.4 M
7A.0 MOS Teams	\$48.9 M		\$48.9 M
7A.03 Tracking (Launch Ops.)	\$0.7 M		\$0.7 M
7A.06 Navigation Operations Team	\$3.7 M		\$3.7 M
7A.07.03 Mission Planning Team	\$0.0 M		\$0.0 M
07B.0 Areo Mothership + SmallSats	\$23.7 M		\$23.7 M
09.0 Ground Data Systems	\$81.8 M		\$81.8 M
09A.0 Mothership + Polar + Elliptical	\$54.6 M		\$54.6 M
9.0A Ground Data System	\$44.8 M		\$44.8 M
9.0B Science Data System Development	\$8.8 M		\$8.8 M
9A.03.07 Navigation H/W & S/W Development	\$0.9 M		\$0.9 M
09B.0 Areo Mothership + SmallSats	\$27.2 M		\$27.2 M
10.0 ATLO	\$64.8 M	\$10.7 M	\$75.4 M
MotherShip	\$31.8 M	\$4.8 M	\$36.5 M
Polar	\$3.6 M	\$3.6 M	\$7.2 M
Elliptical	\$5.7 M	\$2.3 M	\$8.0 M
Areo Mothership + SmallSats	\$23.7 M	\$0.0 M	\$23.7 M
11.0 Education and Public Outreach	\$0.0 M	\$0.0 M	\$0.0 M
12.0 Mission and Navigation Design	\$92.9 M		\$92.9 M
12A.0 Mothership	\$38.1 M		\$38.1 M
12A.01 Mission Design	\$2.9 M		\$2.9 M
12A.02 Mission Analysis	\$9.9 M		\$9.9 M
12A.03 Mission Engineering	\$6.7 M		\$6.7 M
12A.04 Navigation Design	\$18.6 M		\$18.6 M
12B.0 Polar	\$15.2 M		\$15.2 M
12C.0 Elliptical	\$13.2 M		\$13.2 M
12D.0 Areo Mothership + SmallSats	\$26.4 M		\$26.4 M
Development Reserves	\$528.5 M	\$165.9 M	\$694.4 M

Table B-85. Cost E–F for option 2 (25% reserve).

Operations Cost (Phases E–F)	\$466.0M	\$0.2M	\$466.2M
01.0 Project Management	\$11.7M		\$11.7M
1.01 Project Management	\$6.8M		\$6.8M
1.02 Business Management	\$4.4M		\$4.4M
1.04 Project Reviews	\$0.4M		\$0.4M
1.06 Launch Approval	\$0.0M		\$0.0M
02.0 Project Systems Engineering	\$0.0M	\$0.1M	\$0.2M
2.06 Planetary Protection	\$0.0M	\$0.1M	\$0.2M
03.0 Mission Assurance	\$0.0M	\$0.0M	\$0.0M
04.0 Science	\$119.7M		\$119.7M
4A.02 Mothership Science Team	\$114.5M		\$114.5M
4B.02 Polar Science Team	\$1.0M		\$1.0M
4C.02 Elliptical Science Team	\$1.1M		\$1.1M
4D.02 Areo Mothership + SmallSats Science Team	\$3.2M		\$3.2M
06.0 Flight System	\$0.0M		\$0.0M
6.02 Flight System Systems Engineering	\$0.0M		\$0.0M
07.0 Mission Operations	\$193.1M		\$193.1M
07A.0 Mothership + Polar + Elliptical	\$149.7M		\$149.7M
7A.0 MOS Teams	\$117.0M		\$117.0M
7A.03 Tracking	\$23.0M		\$23.0M
7A.06 Navigation Operations Team	\$9.2M		\$9.2M
7A.07.03 Mission Planning Team	\$0.6M		\$0.6M
07B.0 Areo Mothership + SmallSats	\$43.4M		\$43.4M
09.0 Ground Data Systems	\$52.8M		\$52.8M
09.0A Mothership + Polar + Elliptical	\$37.9M		\$151.8M
9.0A GDS Teams	\$12.5M		\$12.5M
9.0B Science Data System Ops	\$25.2M		\$25.2M
9A.03.07 Navigation H/W and S/W Dev	\$0.2M		\$0.2M
09B.0 Areo Mothership + SmallSats	\$14.9M		\$14.9M
11.0 Education and Public Outreach	\$0.0M	\$0.0M	\$0.0M
12.0 Mission and Navigation Design	\$0.0M		\$0.0M
12.01 Mission Design	\$0.0M		\$0.0M
12.02 Mission Analysis	\$0.0M		\$0.0M
12.04 Navigation Design	\$0.0M		\$0.0M
Operations Reserves	\$88.6M	\$0.0M	\$88.6M

Table B-86. Cost E–F for option 2 (15% reserve).

Operations Cost (Phases E–F)	\$430.6M	\$0.2M	\$430.7M
01.0 Project Management	\$11.7M		\$11.7M
1.01 Project Management	\$6.8M		\$6.8M
1.02 Business Management	\$4.4M		\$4.4M
1.04 Project Reviews	\$0.4M		\$0.4M
1.06 Launch Approval	\$0.0M		\$0.0M
02.0 Project Systems Engineering	\$0.0M	\$0.1M	\$0.2M
2.06 Planetary Protection	\$0.0M	\$0.1M	\$0.2M
03.0 Mission Assurance	\$0.0M	\$0.0M	\$0.0M
04.0 Science	\$119.7M		\$119.7M
4A.02 Mothership Science Team	\$114.5M		\$114.5M
4B.02 Polar Science Team	\$1.0M		\$1.0M
4C.02 Elliptical Science Team	\$1.1M		\$1.1M
4D.02 Aero Mothership + SmallSats Science Team	\$3.2M		\$3.2M
06.0 Flight System	\$0.0M		\$0.0M
6.02 Flight System Systems Engineering	\$0.0M		\$0.0M
07.0 Mission Operations	\$193.1M		\$193.1M
07A.0 Mothership + Polar + Elliptical	\$149.7M		\$149.7M
7A.0 MOS Teams	\$117.0M		\$117.0M
7A.03 Tracking	\$23.0M		\$23.0M
7A.06 Navigation Operations Team	\$9.2M		\$9.2M
7A.07.03 Mission Planning Team	\$0.6M		\$0.6M
07B.0 Aero Mothership + SmallSats	\$43.4M		\$43.4M
09.0 Ground Data Systems	\$52.8M		\$52.8M
09.0A Mothership + Polar + Elliptical	\$37.9M		\$151.8M
9.0A GDS Teams	\$12.5M		\$12.5M
9.0B Science Data System Ops	\$25.2M		\$25.2M
9A.03.07 Navigation H/W and S/W Dev	\$0.2M		\$0.2M
09B.0 Aero Mothership + SmallSats	\$14.9M		\$14.9M
11.0 Education and Public Outreach	\$0.0M	\$0.0M	\$0.0M
12.0 Mission and Navigation Design	\$0.0M		\$0.0M
12.01 Mission Design	\$0.0M		\$0.0M
12.02 Mission Analysis	\$0.0M		\$0.0M
12.04 Navigation Design	\$0.0M		\$0.0M
Operations Reserves	\$53.2M	\$0.0M	\$53.2M

Table B-87. Cost A–D for option 3 (50% reserve).

Development Cost (Phases A - D)	\$820.5 M	\$368.7 M	\$1189.2 M
01.0 Project Management	\$21.0 M		\$21.0 M
1.01 Project Management	\$8.9 M		\$8.9 M
1.02 Business Management	\$10.2 M		\$10.2 M
1.04 Project Reviews	\$1.4 M		\$1.4 M
1.06 Launch Approval	\$0.4 M		\$0.4 M
02.0 Project Systems Engineering	\$25.9 M	\$2.9 M	\$28.7 M
2.01 Project Systems Engineering	\$8.9 M		\$8.9 M
2.02 Project SW Systems Engineering	\$5.2 M		\$5.2 M
2.03 EEIS	\$0.6 M		\$0.6 M
2.04 Information System Management	\$1.7 M		\$1.7 M
2.05 Configuration Management	\$1.6 M		\$1.6 M
2.06 Planetary Protection	\$1.5 M	\$2.3 M	\$3.8 M
Mothership	\$1.5 M	\$2.3 M	\$3.8 M
2.07 Contamination Control	\$2.6 M	\$0.6 M	\$3.2 M
2.09 Launch System Engineering	\$1.1 M		\$1.1 M
2.10 Project V&V	\$2.2 M		\$2.2 M
2.11 Risk Management	\$0.5 M		\$0.5 M
03.0 Mission Assurance	\$22.6 M	\$10.1 M	\$32.7 M
04.0 Science	\$21.0 M		\$21.0 M
04.01, 04.02, & 04.03 Science Teams	\$21.0 M		\$21.0 M
05.0 Payload System	\$73.4 M	\$47.8 M	\$121.1 M
5.01 Payload Management	\$4.3 M		\$4.3 M
5.02 Payload Engineering	\$3.1 M		\$3.1 M
Element 01	\$65.9 M	\$47.8 M	\$113.7 M
Visible Imager (MARCI)	\$3.4 M	\$2.5 M	\$5.9 M
Limb Radiometer (Mars Climate Sounder)	\$20.0 M	\$14.5 M	\$34.5 M
Near IR Spect (Thoth Argus)	\$1.6 M	\$1.2 M	\$2.8 M
FUV/MUV Spect (IUVS-MAVEN)	\$40.9 M	\$29.6 M	\$70.5 M

06.0 Flight System	\$290.0 M	\$180.4 M	\$470.4 M
6.01 Flight System Management	\$5.2 M		\$5.2 M
6.02 Flight System Systems Engineering	\$35.8 M		\$35.8 M
6.03 Product Assurance (included in 3.0)			\$0.0 M
Element 01	\$241.6 M	\$177.9 M	\$419.6 M
6.04 Power	\$15.8 M	\$48.6 M	\$64.3 M
6.05 C&DH	\$20.2 M	\$35.1 M	\$55.3 M
6.06 Telecom	\$36.4 M	\$24.1 M	\$60.5 M
6.07 Structures (includes Mech. I&T)	\$42.1 M	\$12.9 M	\$55.1 M
6.08 Thermal	\$3.6 M	\$4.2 M	\$7.8 M
6.09 Propulsion	\$59.4 M	\$30.8 M	\$90.2 M
6.10 ACS	\$18.1 M	\$15.3 M	\$33.4 M
6.11 Harness	\$4.6 M	\$4.5 M	\$9.1 M
6.12 S/C Software	\$37.7 M	\$2.0 M	\$39.7 M
6.13 Materials and Processes	\$3.8 M	\$0.4 M	\$4.2 M
6.14 Spacecraft Testbeds	\$7.4 M	\$2.5 M	\$9.8 M
07.0 Mission Operations Preparation	\$28.1 M		\$28.1 M
7.0 MOS Teams	\$25.2 M		\$25.2 M
7.03 Tracking (Launch Ops.)	\$0.7 M		\$0.7 M
7.06 Navigation Operations Team	\$2.2 M		\$2.2 M
7.07.03 Mission Planning Team	\$0.0 M		\$0.0 M
09.0 Ground Data Systems	\$23.6 M		\$23.6 M
9.0A Ground Data System	\$20.5 M		\$20.5 M
9.0B Science Data System Development	\$2.1 M		\$2.1 M
9A.03.07 Navigation H/W & S/W Development	\$1.0 M		\$1.0 M
10.0 ATLO	\$24.3 M	\$4.6 M	\$28.9 M
11.0 Education and Public Outreach	\$0.0 M	\$0.0 M	\$0.0 M
12.0 Mission and Navigation Design	\$17.4 M		\$17.4 M
12.01 Mission Design	\$2.2 M		\$2.2 M
12.02 Mission Analysis	\$5.0 M		\$5.0 M
12.03 Mission Engineering	\$1.8 M		\$1.8 M
12.04 Navigation Design	\$8.4 M		\$8.4 M
Development Reserves	\$273.2 M	\$122.9 M	\$396.1 M

Table B-88. Cost A–D for option 3 (30% reserve).

Development Cost (Phases A - D)	\$711.3 M	\$319.6 M	\$1030.9 M
01.0 Project Management	\$21.0 M		\$21.0 M
1.01 Project Management	\$8.9 M		\$8.9 M
1.02 Business Management	\$10.2 M		\$10.2 M
1.04 Project Reviews	\$1.4 M		\$1.4 M
1.06 Launch Approval	\$0.4 M		\$0.4 M
02.0 Project Systems Engineering	\$25.9 M	\$2.9 M	\$28.7 M
2.01 Project Systems Engineering	\$8.9 M		\$8.9 M
2.02 Project SW Systems Engineering	\$5.2 M		\$5.2 M
2.03 EEIS	\$0.6 M		\$0.6 M
2.04 Information System Management	\$1.7 M		\$1.7 M
2.05 Configuration Management	\$1.6 M		\$1.6 M
2.06 Planetary Protection	\$1.5 M	\$2.3 M	\$3.8 M
Mothership	\$1.5 M	\$2.3 M	\$3.8 M
2.07 Contamination Control	\$2.6 M	\$0.6 M	\$3.2 M
2.09 Launch System Engineering	\$1.1 M		\$1.1 M
2.10 Project V&V	\$2.2 M		\$2.2 M
2.11 Risk Management	\$0.5 M		\$0.5 M
03.0 Mission Assurance	\$22.7 M	\$10.2 M	\$32.9 M
04.0 Science	\$21.0 M		\$21.0 M
04.01, 04.02, & 04.03 Science Teams	\$21.0 M		\$21.0 M
05.0 Payload System	\$73.4 M	\$47.8 M	\$121.1 M
5.01 Payload Management	\$4.3 M		\$4.3 M
5.02 Payload Engineering	\$3.1 M		\$3.1 M
Element 01	\$65.9 M	\$47.8 M	\$113.7 M
Visible Imager (MARCI)	\$3.4 M	\$2.5 M	\$5.9 M
Limb Radiometer (Mars Climate Sounder)	\$20.0 M	\$14.5 M	\$34.5 M
Near IR Spect (Thoth Argus)	\$1.6 M	\$1.2 M	\$2.8 M
FUV/MUV Spect (IUVS-MAVEN)	\$40.9 M	\$29.6 M	\$70.5 M

06.0 Flight System	\$290.0 M	\$180.4 M	\$470.4 M
6.01 Flight System Management	\$5.2 M		\$5.2 M
6.02 Flight System Systems Engineering	\$35.8 M		\$35.8 M
6.03 Product Assurance (included in 3.0)			\$0.0 M
Element 01	\$241.6 M	\$177.9 M	\$419.6 M
6.04 Power	\$15.8 M	\$48.6 M	\$64.3 M
6.05 C&DH	\$20.2 M	\$35.1 M	\$55.3 M
6.06 Telecom	\$36.4 M	\$24.1 M	\$60.5 M
6.07 Structures (includes Mech. I&T)	\$42.1 M	\$12.9 M	\$55.1 M
6.08 Thermal	\$3.6 M	\$4.2 M	\$7.8 M
6.09 Propulsion	\$59.4 M	\$30.8 M	\$90.2 M
6.10 ACS	\$18.1 M	\$15.3 M	\$33.4 M
6.11 Harness	\$4.6 M	\$4.5 M	\$9.1 M
6.12 S/C Software	\$37.7 M	\$2.0 M	\$39.7 M
6.13 Materials and Processes	\$3.8 M	\$0.4 M	\$4.2 M
6.14 Spacecraft Testbeds	\$7.4 M	\$2.5 M	\$9.8 M
07.0 Mission Operations Preparation	\$28.1 M		\$28.1 M
7.0 MOS Teams	\$25.2 M		\$25.2 M
7.03 Tracking (Launch Ops.)	\$0.7 M		\$0.7 M
7.06 Navigation Operations Team	\$2.2 M		\$2.2 M
7.07.03 Mission Planning Team	\$0.0 M		\$0.0 M
09.0 Ground Data Systems	\$23.6 M		\$23.6 M
9.0A Ground Data System	\$20.5 M		\$20.5 M
9.0B Science Data System Development	\$2.1 M		\$2.1 M
9A.03.07 Navigation H/W & S/W Development	\$1.0 M		\$1.0 M
10.0 ATLO	\$24.3 M	\$4.6 M	\$28.9 M
11.0 Education and Public Outreach	\$0.0 M	\$0.0 M	\$0.0 M
12.0 Mission and Navigation Design	\$17.4 M		\$17.4 M
12.01 Mission Design	\$2.2 M		\$2.2 M
12.02 Mission Analysis	\$5.0 M		\$5.0 M
12.03 Mission Engineering	\$1.8 M		\$1.8 M
12.04 Navigation Design	\$8.4 M		\$8.4 M
Development Reserves	\$164.0 M	\$73.8 M	\$237.7 M

Table B-89. Cost E–F for option 3 (25% reserve).

Operations Cost (Phases E–F)	\$212.0M	\$0.2M	\$430.7M
01.0 Project Management	\$7.3M		\$7.3M
1.01 Project Management	\$4.3M		\$4.3M
1.02 Business Management	\$2.9M		\$2.9M
1.04 Project Reviews	\$0.2M		\$0.2M
1.06 Launch Approval	\$0.0M		\$0.0M
02.0 Project Systems Engineering	\$0.0M	\$0.1M	\$0.2M
2.06 Planetary Protection	\$0.0M	\$0.1M	\$0.2M
03.0 Mission Assurance	\$4.1M	\$0.0M	\$4.1M
04.0 Science	\$52.7M		\$52.7M
4.02 Science Team	\$52.7M		\$52.7M
06.0 Flight System	\$0.0M		\$0.0M
07.0 Mission Operations	\$94.7M		\$94.7M
7.0 MOS Teams	\$62.0M		\$62.0M
7.03 Tracking	\$23.0M		\$23.0M
7.06 Navigation Operations Team	\$9.2M		\$9.2M
7.07.03 Mission Planning Team	\$0.5M		\$0.5M
09.0 Ground Data Systems	\$15.4M		\$15.4M
9.0A GDS Teams	\$9.2M		\$9.2M
9.0B Science Data System Ops	\$6.0M		\$6.0M
9A.03.07 Navigation H/W and S/W Dev	\$0.2M		\$0.2M
11.0 Education and Public Outreach	\$0.0M	\$0.0M	\$0.0M
12.0 Mission and Navigation Design	\$0.0M		\$0.0M
Operations Reserves	\$37.8M	\$0.0M	\$37.8M

Table B-90. Cost E–F for option 3 (15% reserve).

Operations Cost (Phases E–F)	\$196.9M	\$0.2M	\$197.1M
01.0 Project Management	\$7.3M		\$7.3M
1.01 Project Management	\$4.3M		\$4.3M
1.02 Business Management	\$2.9M		\$2.9M
1.04 Project Reviews	\$0.2M		\$0.2M
1.06 Launch Approval	\$0.0M		\$0.0M
02.0 Project Systems Engineering	\$0.0M	\$0.1M	\$0.2M
2.06 Planetary Protection	\$0.0M	\$0.1M	\$0.2M
03.0 Mission Assurance	\$4.1M	\$0.0M	\$4.1M
04.0 Science	\$52.7M		\$52.7M
4.02 Science Team	\$52.7M		\$52.7M
06.0 Flight System	\$0.0M		\$0.0M
07.0 Mission Operations	\$94.7M		\$94.7M
7.0 MOS Teams	\$62.0M		\$62.0M
7.03 Tracking	\$23.0M		\$23.0M
7.06 Navigation Operations Team	\$9.2M		\$9.2M
7.07.03 Mission Planning Team	\$0.5M		\$0.5M
09.0 Ground Data Systems	\$15.4M		\$15.4M
9.0A GDS Teams	\$9.2M		\$9.2M
9.0B Science Data System Ops	\$6.0M		\$6.0M
9A.03.07 Navigation H/W and S/W Dev	\$0.2M		\$0.2M
11.0 Education and Public Outreach	\$0.0M	\$0.0M	\$0.0M
12.0 Mission and Navigation Design	\$0.0M		\$0.0M
Operations Reserves	\$22.7M	\$0.0M	\$22.7M

Table B-91. Cost A–D for option 4 (50% reserve).

Development Cost (Phases A - D)	\$1878.1 M	\$510.0 M	\$2388.1 M
01.0 Project Management	\$30.4 M		\$30.4 M
1.01 Project Management	\$12.6 M		\$12.6 M
1.02 Business Management	\$14.8 M		\$14.8 M
1.04 Project Reviews	\$2.6 M		\$2.6 M
1.06 Launch Approval	\$0.4 M		\$0.4 M
02.0 Project Systems Engineering	\$68.4 M	\$5.6 M	\$74.0 M
2.01 Project Systems Engineering	\$23.4 M		\$23.4 M
2.02 Project SW Systems Engineering	\$6.8 M		\$6.8 M
2.03 EEIS	\$5.4 M		\$5.4 M
2.04 Information System Management	\$5.7 M		\$5.7 M
2.05 Configuration Management	\$6.9 M		\$6.9 M
2.06 Planetary Protection	\$5.4 M	\$5.0 M	\$10.4 M
MotherShip	\$1.5 M	\$2.3 M	\$3.8 M
Polar	\$1.3 M	\$1.8 M	\$3.1 M
Elliptical	\$1.3 M	\$0.9 M	\$2.2 M
Areo Mothership + SmallSats	\$1.3 M		\$1.3 M
2.07 Contamination Control	\$2.6 M	\$0.6 M	\$3.2 M
2.09 Launch System Engineering	\$1.7 M		\$1.7 M
2.10 Project V&V	\$4.5 M		\$4.5 M
2.11 Risk Management	\$6.1 M		\$6.1 M
03.0 Mission Assurance	\$51.2 M	\$13.9 M	\$65.0 M
04.0 Science	\$33.3 M		\$33.3 M
05.0 Payload System	\$231.9 M	\$62.2 M	\$294.1 M
5.01 Payload Management	\$39.3 M		\$39.3 M
5.02 Payload Engineering	\$36.1 M		\$36.1 M
MotherShip	\$65.9 M	\$47.8 M	\$113.7 M
Polar	\$8.4 M	\$6.9 M	\$15.3 M
Elliptical	\$18.9 M	\$7.5 M	\$26.4 M
Areo Mothership	\$55.7 M	\$0.0 M	\$55.7 M
Areo Smallsats	\$7.6 M	\$0.0 M	\$7.6 M
06.0 Flight System	\$542.1 M	\$247.7 M	\$789.8 M
6.01 Flight System Management	\$20.1 M		\$20.1 M
6.01A Mothership	\$5.7 M		\$5.7 M
6.01B Polar	\$2.9 M		\$2.9 M
6.01C Elliptical	\$2.7 M		\$2.7 M
6.01D Areo Mothership + SmallSats	\$8.8 M		\$8.8 M
6.02 Flight System Systems Engineering	\$55.6 M		\$55.6 M
6.01A Mothership	\$41.5 M		\$41.5 M
6.01B Polar	\$2.9 M		\$2.9 M
6.01C Elliptical	\$2.6 M		\$2.6 M
6.01D Areo Mothership + SmallSats	\$8.6 M		\$8.6 M
MotherShip	\$241.6 M	\$177.9 M	\$419.6 M
6.04 Power	\$15.8 M	\$48.6 M	\$64.3 M
6.05 C&DH	\$20.2 M	\$35.1 M	\$55.3 M
6.06 Telecom	\$36.4 M	\$24.1 M	\$60.5 M
6.07 Structures (includes Mech. I&T)	\$42.1 M	\$12.9 M	\$55.1 M
6.08 Thermal	\$3.6 M	\$4.2 M	\$7.8 M
6.09 Propulsion	\$59.4 M	\$30.8 M	\$90.2 M
6.10 ACS	\$18.1 M	\$15.3 M	\$33.4 M
6.11 Harness	\$4.6 M	\$4.5 M	\$9.1 M
6.12 S/C Software	\$37.7 M	\$2.0 M	\$39.7 M
6.13 Materials and Processes	\$3.8 M	\$0.4 M	\$4.2 M
Polar	\$28.7 M	\$29.2 M	\$57.9 M
Elliptical	\$38.1 M	\$14.9 M	\$53.0 M
Areo Mothership	\$121.2 M	\$0.0 M	\$121.2 M
Areo SmallSats	\$28.6 M	\$22.9 M	\$51.5 M
6.14 Spacecraft Testbeds	\$8.3 M	\$2.8 M	\$11.0 M
07.0 Mission Operations Preparation	\$72.4 M		\$72.4 M
07A.0 Mothership + Polar + Elliptical	\$48.7 M		\$48.7 M
7A.0 MOS Teams	\$43.8 M		\$43.8 M
7A.03 Tracking (Launch Ops.)	\$0.7 M		\$0.7 M
7A.06 Navigation Operations Team	\$4.2 M		\$4.2 M
7A.07.03 Mission Planning Team	\$0.0 M		\$0.0 M
07B.0 Areo Mothership + SmallSats	\$23.7 M		\$23.7 M
09.0 Ground Data Systems	\$75.0 M		\$75.0 M
09A.0 Mothership + Polar + Elliptical	\$47.8 M		\$47.8 M
9.0A Ground Data System	\$39.5 M		\$39.5 M
9.0B Science Data System Development	\$7.3 M		\$7.3 M
9A.03.07 Navigation H/W & S/W Development	\$1.0 M		\$1.0 M
09B.0 Areo Mothership + SmallSats	\$27.2 M		\$27.2 M
10.0 ATLO	\$61.6 M	\$10.6 M	\$72.2 M
MotherShip	\$28.6 M	\$4.7 M	\$33.3 M
Polar	\$3.6 M	\$3.6 M	\$7.2 M
Elliptical	\$5.7 M	\$2.3 M	\$8.0 M
Areo Mothership + SmallSats	\$23.7 M	\$0.0 M	\$23.7 M
11.0 Education and Public Outreach	\$0.0 M	\$0.0 M	\$0.0 M
12.0 Mission and Navigation Design	\$86.0 M		\$86.0 M
12A.0 Mothership	\$31.2 M		\$31.2 M
12A.01 Mission Design	\$2.4 M		\$2.4 M
12A.02 Mission Analysis	\$8.6 M		\$8.6 M
12A.03 Mission Engineering	\$5.4 M		\$5.4 M
12A.04 Navigation Design	\$14.9 M		\$14.9 M
12B.0 Polar	\$15.2 M		\$15.2 M
12C.0 Elliptical	\$13.2 M		\$13.2 M
12D.0 Areo Mothership + SmallSats	\$26.4 M		\$26.4 M
Development Reserves	\$625.8 M	\$170.0 M	\$795.8 M

Table B-92. Cost A–D for option 4 (30% reserve).

Development Cost (Phases A - D)	\$1627.8 M	\$442.0 M	\$2069.8 M
01.0 Project Management	\$30.4 M		\$30.4 M
1.01 Project Management	\$12.6 M		\$12.6 M
1.02 Business Management	\$14.8 M		\$14.8 M
1.04 Project Reviews	\$2.6 M		\$2.6 M
1.06 Launch Approval	\$0.4 M		\$0.4 M
02.0 Project Systems Engineering	\$68.4 M	\$5.6 M	\$74.0 M
2.01 Project Systems Engineering	\$23.4 M		\$23.4 M
2.02 Project SW Systems Engineering	\$6.8 M		\$6.8 M
2.03 EEIS	\$5.4 M		\$5.4 M
2.04 Information System Management	\$5.7 M		\$5.7 M
2.05 Configuration Management	\$6.9 M		\$6.9 M
2.06 Planetary Protection	\$5.4 M	\$5.0 M	\$10.4 M
MotherShip	\$1.5 M	\$2.3 M	\$3.8 M
Polar	\$1.3 M	\$1.8 M	\$3.1 M
Elliptical	\$1.3 M	\$0.9 M	\$2.2 M
Areo Mothership + SmallSats	\$1.3 M		\$1.3 M
2.07 Contamination Control	\$2.6 M	\$0.6 M	\$3.2 M
2.09 Launch System Engineering	\$1.7 M		\$1.7 M
2.10 Project V&V	\$4.5 M		\$4.5 M
2.11 Risk Management	\$6.1 M		\$6.1 M
03.0 Mission Assurance	\$51.2 M	\$13.9 M	\$65.0 M
04.0 Science	\$33.3 M		\$33.3 M
05.0 Payload System	\$231.9 M	\$62.2 M	\$294.1 M
5.01 Payload Management	\$39.3 M		\$39.3 M
5.02 Payload Engineering	\$36.1 M		\$36.1 M
MotherShip	\$65.9 M	\$47.8 M	\$113.7 M
Polar	\$8.4 M	\$6.9 M	\$15.3 M
Elliptical	\$18.9 M	\$7.5 M	\$26.4 M
Areo Mothership	\$55.7 M	\$0.0 M	\$55.7 M
Areo Smallsats	\$7.6 M	\$0.0 M	\$7.6 M
06.0 Flight System	\$542.1 M	\$247.7 M	\$789.8 M
6.01 Flight System Management	\$20.1 M		\$20.1 M
6.01A Mothership	\$5.7 M		\$5.7 M
6.01B Polar	\$2.9 M		\$2.9 M
6.01C Elliptical	\$2.7 M		\$2.7 M
6.01D Areo Mothership + SmallSats	\$8.8 M		\$8.8 M
6.02 Flight System Systems Engineering	\$55.6 M		\$55.6 M
6.01A Mothership	\$41.5 M		\$41.5 M
6.01B Polar	\$2.9 M		\$2.9 M
6.01C Elliptical	\$2.6 M		\$2.6 M
6.01D Areo Mothership + SmallSats	\$8.6 M		\$8.6 M

Mothership	\$241.6 M	\$177.9 M	\$419.6 M
6.04 Power	\$15.8 M	\$48.6 M	\$64.3 M
6.05 C&DH	\$20.2 M	\$35.1 M	\$55.3 M
6.06 Telecom	\$36.4 M	\$24.1 M	\$60.5 M
6.07 Structures (includes Mech. I&T)	\$42.1 M	\$12.9 M	\$55.1 M
6.08 Thermal	\$3.6 M	\$4.2 M	\$7.8 M
6.09 Propulsion	\$59.4 M	\$30.8 M	\$90.2 M
6.10 ACS	\$18.1 M	\$15.3 M	\$33.4 M
6.11 Harness	\$4.6 M	\$4.5 M	\$9.1 M
6.12 S/C Software	\$37.7 M	\$2.0 M	\$39.7 M
6.13 Materials and Processes	\$3.8 M	\$0.4 M	\$4.2 M
Polar	\$28.7 M	\$29.2 M	\$57.9 M
Elliptical	\$38.1 M	\$14.9 M	\$53.0 M
Areo Mothership	\$121.2 M	\$0.0 M	\$121.2 M
Areo SmallSats	\$28.6 M	\$22.9 M	\$51.5 M
6.14 Spacecraft Testbeds	\$8.3 M	\$2.8 M	\$11.0 M
07.0 Mission Operations Preparation	\$72.4 M		\$72.4 M
07A.0 Mothership + Polar + Elliptical	\$48.7 M		\$48.7 M
7A.0 MOS Teams	\$43.8 M		\$43.8 M
7A.03 Tracking (Launch Ops.)	\$0.7 M		\$0.7 M
7A.06 Navigation Operations Team	\$4.2 M		\$4.2 M
7A.07.03 Mission Planning Team	\$0.0 M		\$0.0 M
07B.0 Areo Mothership + SmallSats	\$23.7 M		\$23.7 M
09.0 Ground Data Systems	\$75.0 M		\$75.0 M
09A.0 Mothership + Polar + Elliptical	\$47.8 M		\$47.8 M
9.0A Ground Data System	\$39.5 M		\$39.5 M
9.0B Science Data System Development	\$7.3 M		\$7.3 M
9A.03.07 Navigation H/W & S/W Development	\$1.0 M		\$1.0 M
09B.0 Areo Mothership + SmallSats	\$27.2 M		\$27.2 M
10.0 ATLO	\$61.6 M	\$10.6 M	\$72.2 M
Mothership	\$28.6 M	\$4.7 M	\$33.3 M
Polar	\$3.6 M	\$3.6 M	\$7.2 M
Elliptical	\$5.7 M	\$2.3 M	\$8.0 M
Areo Mothership + SmallSats	\$23.7 M	\$0.0 M	\$23.7 M
11.0 Education and Public Outreach	\$0.0 M	\$0.0 M	\$0.0 M
12.0 Mission and Navigation Design	\$86.0 M		\$86.0 M
12A.0 Mothership	\$31.2 M		\$31.2 M
12A.01 Mission Design	\$2.4 M		\$2.4 M
12A.02 Mission Analysis	\$8.6 M		\$8.6 M
12A.03 Mission Engineering	\$5.4 M		\$5.4 M
12A.04 Navigation Design	\$14.9 M		\$14.9 M
12B.0 Polar	\$15.2 M		\$15.2 M
12C.0 Elliptical	\$13.2 M		\$13.2 M
12D.0 Areo Mothership + SmallSats	\$26.4 M		\$26.4 M
Development Reserves	\$375.5 M	\$102.0 M	\$477.5 M

Table B-93. Cost E–F for option 4 (25% reserve).

Operations Cost (Phases E–F)	\$404.0M	\$0.2M	\$404.2M
01.0 Project Management	\$11.7M		\$11.7M
1.01 Project Management	\$6.8M		\$6.8M
1.02 Business Management	\$4.4M		\$4.4M
1.04 Project Reviews	\$0.4M		\$0.4M
1.06 Launch Approval	\$0.0M		\$0.0M
02.0 Project Systems Engineering	\$0.0M	\$0.1M	\$0.2M
2.06 Planetary Protection	\$0.0M	\$0.1M	\$0.2M
03.0 Mission Assurance	\$0.0M	\$0.0M	\$0.0M
04.0 Science	\$58.0M		\$58.0M
4A.02 Mothership Science Team	\$52.7M		\$52.7M
4B.02 Polar Science Team	\$1.0M		\$1.0M
4C.02 Elliptical Science Team	\$1.1M		\$1.1M
4D.02 Aero Mothership + SmallSats Science Team	\$3.2M		\$3.2M
06.0 Flight System	\$0.0M		\$0.0M
6.02 Flight System Systems Engineering	\$0.0M		\$0.0M
07.0 Mission Operations	\$208.3M		\$208.3M
07A.0 Mothership + Polar + Elliptical	\$164.9M		\$164.9M
7A.0 MOS Teams	\$131.1M		\$131.1M
7A.03 Tracking	\$23.0M		\$23.0M
7A.06 Navigation Operations Team	\$10.2M		\$10.2M
7A.07.03 Mission Planning Team	\$0.6M		\$0.6M
07B.0 Aero Mothership + SmallSats	\$43.4M		\$43.4M
09.0 Ground Data Systems	\$49.9M		\$49.9M
09.0A Mothership + Polar + Elliptical	\$35.0M		\$139.9M
9.0A GDS Teams	\$13.8M		\$13.8M
9.0B Science Data System Ops	\$20.9M		\$20.9M
9A.03.07 Navigation H/W and S/W Dev	\$0.2M		\$0.2M
09B.0 Aero Mothership + SmallSats	\$14.9M		\$14.9M
11.0 Education and Public Outreach	\$0.0M	\$0.0M	\$0.0M
12.0 Mission and Navigation Design	\$0.0M		\$0.0M
12.01 Mission Design	\$0.0M		\$0.0M
12.02 Mission Analysis	\$0.0M		\$0.0M
12.04 Navigation Design	\$0.0M		\$0.0M
Operations Reserves	\$76.2M	\$0.0M	\$76.2M

Table B-94. Cost E–F for option 4 (15% reserve).

Operations Cost (Phases E–F)	\$373.6M	\$0.2M	\$373.7M
01.0 Project Management	\$11.7M		\$11.7M
1.01 Project Management	\$6.8M		\$6.8M
1.02 Business Management	\$4.4M		\$4.4M
1.04 Project Reviews	\$0.4M		\$0.4M
1.06 Launch Approval	\$0.0M		\$0.0M
02.0 Project Systems Engineering	\$0.0M	\$0.1M	\$0.2M
2.06 Planetary Protection	\$0.0M	\$0.1M	\$0.2M
03.0 Mission Assurance	\$0.0M	\$0.0M	\$0.0M
04.0 Science	\$58.0M		\$58.0M
4A.02 Mothership Science Team	\$52.7M		\$52.7M
4B.02 Polar Science Team	\$1.0M		\$1.0M
4C.02 Elliptical Science Team	\$1.1M		\$1.1M
4D.02 Aero Mothership + SmallSats Science Team	\$3.2M		\$3.2M
06.0 Flight System	\$0.0M		\$0.0M
6.02 Flight System Systems Engineering	\$0.0M		\$0.0M
07.0 Mission Operations	\$208.3M		\$208.3M
07A.0 Mothership + Polar + Elliptical	\$164.9M		\$164.9M
7A.0 MOS Teams	\$131.1M		\$131.1M
7A.03 Tracking	\$23.0M		\$23.0M
7A.06 Navigation Operations Team	\$10.2M		\$10.2M
7A.07.03 Mission Planning Team	\$0.6M		\$0.6M
07B.0 Aero Mothership + SmallSats	\$43.4M		\$43.4M
09.0 Ground Data Systems	\$49.9M		\$49.9M
09.0A Mothership + Polar + Elliptical	\$35.0M		\$139.9M
9.0A GDS Teams	\$13.8M		\$13.8M
9.0B Science Data System Ops	\$20.9M		\$20.9M
9A.03.07 Navigation H/W and S/W Dev	\$0.2M		\$0.2M
09B.0 Aero Mothership + SmallSats	\$14.9M		\$14.9M
11.0 Education and Public Outreach	\$0.0M	\$0.0M	\$0.0M
12.0 Mission and Navigation Design	\$0.0M		\$0.0M
12.01 Mission Design	\$0.0M		\$0.0M
12.02 Mission Analysis	\$0.0M		\$0.0M
12.04 Navigation Design	\$0.0M		\$0.0M
Operations Reserves	\$45.7M	\$0.0M	\$45.7M

Cost rationale

- Cost Drivers
 - The number of instruments and the multi-element components.
 - This then drives the mission into a flagship category resulting in a longer schedule and more labor hours.
- Potential Cost Savings
 - Procuring wherever possible reduces costs. For this mission, procuring the spacecraft for the SmallSat constellations could be a significant cost savings.
 - Procuring operations services from the spacecraft vendors could also save on costs.
 - Contributions
- Potential Cost Uppers

- Unknown whether NASA will allow SmallSat elements to be a Class D risk posture when part of a large Flagship mission. If they must be a lower risk class, there will be cost growth.
- This is especially true for the Areostationary Carrier element, as it is a high cost and thus may be beyond a Class D risk classification

Cost Risks and Mitigation Plans

Although we have done Mars orbiters before, we have never done a mission with mothership and a constellation of SmallSats and daughterships in Mars’ orbit. These are uncharted waters and we don’t have a good analogous mission to compare to and draw lessons-learned from.

Cost option comparison

- Option 1: \$2.6B
 - Mothership w/ 8 instruments
 - Flagship Class
- Option 2: \$3.9B
 - Same mothership technical design as option 1, but the cost accounting includes a full project-level roll-up of all of the elements in the constellation
- Option 3: \$1.4B
 - Mothership w/ 4 instruments
 - New Frontiers Class
- Option 4: \$2.8B
 - Same mothership technical design as option 3, but the cost accounting includes a full project-level roll-up of all of the elements in the constellation

The cost option comparison is shown in Table B-95 with 50% reserve and in Table B-96 with 30% reserve.

Table B-95. Cost option comparison with 50% reserve.

	Option 1	Option 2	Option 3	Option 4
Project Cost	\$2601.4M	\$3939.1M	\$1401.4M	\$2792.3M
Launch Vehicle	\$0.0M	\$0.0M	\$0.0M	\$0.0M
Project Cost (w/o LV)	\$2601.4M	\$3939.1M	\$1401.4M	\$2792.3M
Development Cost	\$2296.4M	\$3472.9M	\$1189.2M	\$2388.1M
Operations Cost	\$305.0M	\$466.2M	\$212.2M	\$404.2M
WBS Elements	1st Unit	1st Unit	1st Unit	1st Unit
Project Cost (including Launch Vehicle)	\$2601.4M	\$3939.1M	\$1401.4M	\$2792.3M
Development Cost (Phases A–D)	\$2296.4M	\$3472.9M	\$1189.2M	\$2388.1M
01.0 Project Management	\$41.5M	\$41.5M	\$21.0M	\$30.4M
02.0 Project Systems Engineering	\$54.5M	\$98.8M	\$28.7M	\$74.0M
03.0 Mission Assurance	\$66.3M	\$99.1M	\$32.7M	\$65.0M
04.0 Science	\$68.4M	\$80.7M	\$21.0M	\$33.3M
05.0 Payload System	\$489.1M	\$686.8M	\$121.1M	\$294.1M
06.0 Flight System	\$665.6M	\$981.4M	\$470.4M	\$789.8M
07.0 Mission Operations Preparation	\$36.4M	\$77.1M	\$28.1M	\$72.4M
09.0 Ground Data Systems	\$39.5M	\$81.8M	\$23.6M	\$75.0M
10.0 ATLO	\$40.5M	\$75.4M	\$28.9M	\$72.2M
11.0 Education and Public Outreach	\$0.0M	\$0.0M	\$0.0M	\$0.0M
12.0 Mission and Navigation Design	\$29.3M	\$92.9M	\$17.4M	\$86.0M
Development Reserves	\$765.2M	\$1157.4M	\$396.1M	\$795.8M
Operations Cost (Phases E–F)	\$305.0M	\$466.2M	\$212.2M	\$404.2M
01.0 Project Management	\$11.7M	\$11.7M	\$7.3M	\$11.7M
02.0 Project Systems Engineering	\$0.2M	\$0.2M	\$0.2M	\$0.2M
03.0 Mission Assurance	\$4.1M	\$0.0M	\$4.1M	\$0.0M
04.0 Science	\$114.5M	\$119.7M	\$52.7M	\$58.0M
06.0 Flight System	\$0.0M	\$0.0M	\$0.0M	\$0.0M
07.0 Mission Operations	\$95.4M	\$193.1M	\$94.7M	\$208.3M
09.0 Ground Data Systems	\$22.7M	\$52.8M	\$15.4M	\$49.9M
11.0 Education and Public Outreach	\$0.0M	\$0.0M	\$0.0M	\$0.0M
12.0 Mission and Navigation Design	\$0.0M	\$0.0M	\$0.0M	\$0.0M
Operations Reserves	\$56.4M	\$88.6M	\$37.8M	\$76.2M
8.0 Launch Vehicle	\$0.0M	\$0.0M	\$0.0M	\$0.0M
Launch Vehicle and Processing	\$0.0M	\$0.0M	\$0.0M	\$0.0M
Nuclear Payload Support	\$0.0M	\$0.0M	\$0.0M	\$0.0M

Table B-96. Cost option comparison with 30% reserve.

	Option 1	Option 2	Option 3	Option 4
Project Cost	\$2272.8M	\$3440.7M	\$1227.8M	\$2443.5M
Launch Vehicle	\$0.0M	\$0.0M	\$0.0M	\$0.0M
Project Cost (w/o LV)	\$2272.8M	\$3440.7M	\$1227.8M	\$2443.5M
Development Cost	\$1990.3M	\$3010.0M	\$1030.7M	\$2069.8M
Operations Cost	\$282.4M	\$430.7M	\$197.1M	\$373.7M
WBS Elements	1st Unit	1st Unit	1st Unit	1st Unit
Project Cost (including Launch Vehicle)	\$2272.8M	\$3440.7M	\$1227.8M	\$2443.5M
Development Cost (Phases A–D)	\$1990.3M	\$3010.0M	\$1030.7M	\$2069.8M
01.0 Project Management	\$41.5M	\$41.5M	\$21.0M	\$30.4M
02.0 Project Systems Engineering	\$54.5M	\$98.8M	\$28.7M	\$74.0M
03.0 Mission Assurance	\$66.3M	\$99.1M	\$32.7M	\$65.0M
04.0 Science	\$68.4M	\$80.7M	\$21.0M	\$33.3M
05.0 Payload System	\$489.1M	\$686.8M	\$121.1M	\$294.1M
06.0 Flight System	\$665.6M	\$981.4M	\$470.4M	\$789.8M
07.0 Mission Operations Preparation	\$36.4M	\$77.1M	\$28.1M	\$72.4M
09.0 Ground Data Systems	\$39.5M	\$81.8M	\$23.6M	\$75.0M
10.0 ATLO	\$40.5M	\$75.4M	\$28.9M	\$72.2M
11.0 Education and Public Outreach	\$0.0M	\$0.0M	\$0.0M	\$0.0M
12.0 Mission and Navigation Design	\$29.3M	\$92.9M	\$17.4M	\$86.0M
Development Reserves	\$459.1M	\$694.4M	\$237.7M	\$477.5M
Operations Cost (Phases E–F)	\$282.4M	\$430.7M	\$197.1M	\$373.7M
01.0 Project Management	\$11.7M	\$11.7M	\$7.3M	\$11.7M
02.0 Project Systems Engineering	\$0.2M	\$0.2M	\$0.2M	\$0.2M
03.0 Mission Assurance	\$4.1M	\$0.0M	\$4.1M	\$0.0M
04.0 Science	\$114.5M	\$119.7M	\$52.7M	\$58.0M
06.0 Flight System	\$0.0M	\$0.0M	\$0.0M	\$0.0M
07.0 Mission Operations	\$95.4M	\$193.1M	\$94.7M	\$208.3M
09.0 Ground Data Systems	\$22.7M	\$52.8M	\$15.4M	\$49.9M
11.0 Education and Public Outreach	\$0.0M	\$0.0M	\$0.0M	\$0.0M
12.0 Mission and Navigation Design	\$0.0M	\$0.0M	\$0.0M	\$0.0M
Operations Reserves	\$33.8M	\$53.2M	\$22.7M	\$45.7M
8.0 Launch Vehicle	\$0.0M	\$0.0M	\$0.0M	\$0.0M
Launch Vehicle and Processing	\$0.0M	\$0.0M	\$0.0M	\$0.0M
Nuclear Payload Support	\$0.0M	\$0.0M	\$0.0M	\$0.0M

B.5 Team X Follow On Design Study Report Summary

The Team X Follow On design study investigated a “mini mothership” as a possible addition to the constellation carried to Mars or as a replenishment option should the Mothership fail. It is based on the Team X design study summarized in Appendix B.4 which is referred to as Study #2238 in the report. The mention of Study #2238 is a typo, this should also be referring to Study #2328. The Team X Follow On design study adds 3 options to the trade space: Option 5-7. Options 1-4 were covered in Appendix B.4. It should be noted that the **analysis and results in this Team X Follow On design study are very conservative.**

In this Team X Follow On design study only the Team X systems report was prepared; this design study approximates the effects of the “design deltas” at a systems level. The study does not include subsystem-level designs or subsystem-level effects. The effects on the spacecraft mass are estimated.

Systems-level changes have been propagated through copies of the subsystem workbooks from the Team X design study summarized in Appendix B.4 (specifically through Propulsion, Mechanical, and Power). However, the changes in the workbooks from the Team X design study from Appendix B.4 have not been reviewed by the Team X subsystem chairs and do not represent their designs. Discrete design changes may in fact be required, which are not captured (e.g. tank selection, ACS design changes, CDS interface changes, battery sizing, mission design changes/opportunities). Therefore, this study may underestimate the effects of the design changes, because it may not capture:

- Reductions in complexity that could result in not having carried elements (elimination of relay comm, reduced data interfaces, reduced mass properties challenges, mission design and navigation simplification)
- Changes to hardware selection that could result from reduced overall system size (smaller EP engines, reduced reaction wheel size)

The following pages provide the Team X Follow On Design Study Report.

Systems Report

Author: Jonathan Murphy

Email: jonathan.murphy@jpl.nasa.gov

Phone: 818-354-0360



TEAMX

Jet Propulsion Laboratory

- This Team X session is in support of a Pre-Decadal Mission Concept Study (PMCS) for the Planetary Decadal Survey, for a concept called MOSAIC (Mars Orbiters for Surface-Atmosphere-Ionosphere Connections)
 - MOSAIC is a constellation of Mars orbiters, with 10 total spacecraft in various orbits
- This study is a follow-on study to Study #2328, “Mars Pre-Decadal MOSAIC”, 2020-03.
 - That study examined two primary technical options, both of which consist of a Mothership spacecraft that carries several Daughterships to Mars orbit, and provide Comm relay for them
 - This study is to estimate, **at a Systems level**, the effects of removing the carried daughterships
- **Study Inputs**
 - Report and workbooks from Study #2328
 - Customer guidelines on desired delta:
 - Removal of all carried elements, such that they are no longer carried on the launch and are no longer carried to Mars
 - Retain ability to provide comm relay for those elements
- **Team X Outputs**
 - Revised Spacecraft mass and cost numbers for the “daughtership-free” spacecraft

- The study examined three options, which were variants on two of the options from study #2238

Options in the previous study (#2328):

- **Option 1** carries **8 instruments** on the Mothership, and only the **Mothership** is costed
 - Note that in the study, this design was “closed” to establish feasibility; however, the propulsion system was left **sized to the launch allocation**, rather than converging the size down to the actual wet mass of Mothership/Daughtership stack, to save time in the study and allow the team to move on to Option 3. This resulted in a total mass and cost that were higher than they would have been if the design were sized to actual wet mass.
- **Option 2** is the same technical design as Option 1, but the cost accounting includes a full project-level roll-up of **all of the elements** in the constellation
- **Option 3** carries **4 instruments** on the Mothership, and only the **Mothership** is costed
 - This design was **converged down to the actual wet mass**.
- **Option 4** is the same technical design as Option 3, but the cost accounting includes a full project-level roll-up of **all of the elements** in the constellation

Options in this study (#222):

- **Option 5** is a variant on **Option 1**, where the Propellant has been **sized to the actual wet mass**, rather than to the Launch Vehicle allocation
 - This option was created in order to allow a “clean delta” for Option 6
 - It used the re-scalable Propulsion design description from Option 3 of study #2328, which allows EP power to scale proportionally to wet mass
- **Option 6** is a variant on **Option 5**, where now the carried **Daughterships have been removed**
- **Option 7** is a variant on **Option 3**, where the carried **Daughterships have been removed**

Assumptions and Caveats

- This study **approximates the effects of the “Design Deltas” at a Systems level**
- This does **not** include subsystem-level designs, or subsystem-level effects
- The effects on the spacecraft mass are **estimated**
- Systems-level changes have been propagated through copies of the subsystem workbooks from the previous study (specifically through Propulsion, Mechanical, and Power)
- **However**, the changes in those workbooks have **not** been reviewed by subsystem chairs, and **do not** represent their designs
- Discrete design changes may in fact be required, which are not captured (e.g. tank selection, ACS design changes, CDS interface changes, battery sizing, mission design changes/opportunities)
- **This study may under-estimate the effects of the design changes**, because it may not capture:
 - A) Reductions in complexity that could result in not having carried elements (elimination of relay comm, reduced data interfaces, reduced mass properties challenges, mission design and navigation simplification)
 - B) Changes to hardware selection that could result from reduced overall system size (smaller EP engines, reduced Reaction Wheel size)

Spacecraft Mass Values and Deltas

- The table below shows the estimated masses and mass deltas due to the design changes in this study
- Note that the “Required Mass Allocation” values are in fact computed bottoms-up, such that the spacecraft has a 30% JPL margin; they are **not** Launch Vehicle allocations
- Re-sizing the propellant to the wet mass (Option 1 → Option 5) reduced the Spacecraft wet mass by 12%
- Removing the carried elements resulted in reductions in spacecraft wet mass:
 - 18% reduction with the “Full Payload” (Option 5 → Option 6)
 - 25% reduction with the “Reduced Payload” (Option 3 → Option 7)

Parameter	units	Full Payload					Reduced Payload		
		Option 1	delta	Option 5	delta	Option 6	Option 3	delta	Option 7
<i>Study ID</i>		2328		222		222	2328		222
Spacecraft dry mass (MEV)	kg	1903	-6.0%	1789	-9.5%	1619	1259	-13.9%	1085
Propellant mass	kg	1549	-21.2%	1221	-33.8%	808	979	-43.0%	558
Spacecraft required wet Mass Allocation	kg	3722	-12.2%	3268	-18.3%	2669	2439	-25.1%	1826
Spacecraft JPL Margin	%	30%	0.0%	30%	0.0%	30%	30%	0.0%	30%
Spacecraft NASA Margin	%	14%	0.3%	14%	0.5%	15%	16%	1.0%	17%
Carried LMO SmallSats Mass Allocation	kg	907	0.0%	907	-100.0%	0	907	-100.0%	0
Mothership with Carried Elements required Mass Allocation	kg	4629	-9.8%	4175	-36.1%	2669	3346	-45.4%	1826

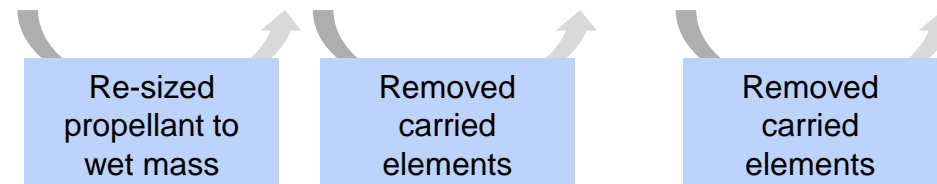

Cost Deltas and Values

- The table below summarizes the cost results (see Cost Report) in the same format as the Systems results
- Note that Operations Costs should be identical in Options 1, 5, and 6; the delta between 5 and 6 is a result of an unincorporated update to GDS costs, and can be ignored
- Importantly, note that the **cost deltas due to removing carried elements are very minor**. See earlier note on caveats; it is possible that this is an under-estimate, but it is not unreasonable for the delta to be small. The principal changes to the design are those of *magnitude*, not to the complexity of the system. The propulsion system doesn't have to push as much mass, and this can ripple through tank size, primary structure, and solar array size. But the design does not enter a new regime; it just re-scales, and the work to implement it would not change much.

Parameter	units	Full Payload					Reduced Payload		
		Option 1	delta	Option 5	delta	Option 6	Option 3	delta	Option 7
Costs									
WBS 6.0 (Flight System) Cost (w/o Reserves)	\$M (FY25)	666	-1.4%	656	-2.1%	643	470	-2.8%	457
Costs with 50%/25% Reserves									
Project Cost (w/o LV)	\$M (FY25)	2601	-0.6%	2587	-0.6%	2571	1401	-1.5%	1381
Development Cost (50% Reserves)	\$M (FY25)	2296	-0.6%	2282	-0.9%	2262	1189	-1.8%	1168
Operations Cost (25% Reserves)	\$M (FY25)	305	0.0%	305	1.2%	309	212	0.0%	212
Costs with 30%/15% Reserves									
Project Cost (w/o LV)	\$M (FY25)	2273	-0.6%	2260	-0.6%	2246	1228	-1.5%	1210
Development Cost (30% Reserves)	\$M (FY25)	1990	-0.6%	1977	-0.9%	1961	1031	-1.8%	1013
Operations Cost (15% Reserves)	\$M (FY25)	282	0.0%	282	1.2%	286	197	0.0%	197

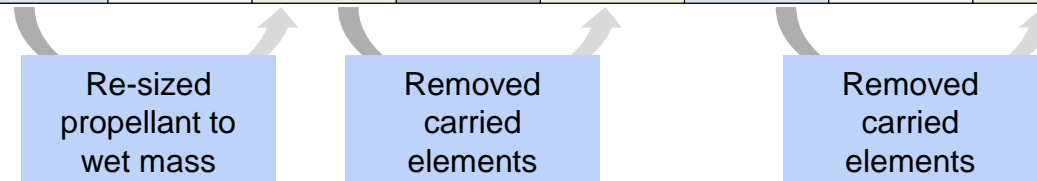

Cost Report

Author: Anto Kolanjian

Email: anto@jpl.nasa.gov

Phone: 626-390-7741



TEAMX
Jet Propulsion Laboratory

The costs presented in this report are ROM estimates, not point estimates or cost commitments. It is likely that each estimate could range from as much as 20% percent higher to 10% lower. The costs presented are based on Pre-Phase A design information, which is subject to change.

- Fiscal Year Dollars: 2025
- Cost Target: Options 1,2,4: No cap (Flagship-class); Option 3: \$1.1B Phase A-D (New Frontiers class)

Options in the previous study (#2328):

- **Option 1** carries **8 instruments** on the Mothership, and only the **Mothership** is costed
 - Note that in the study, this design was “closed” to establish feasibility; however, the propulsion system was left **sized to the launch allocation**, rather than converging the size down to the actual wet mass of Mothership/Daughtership stack, to save time in the study and allow the team to move on to Option 3. This resulted in a total mass and cost that were higher than they would have been if the design were sized to actual wet mass.
- **Option 2** is the same technical design as Option 1, but the cost accounting includes a full project-level roll-up of **all of the elements** in the constellation
- **Option 3** carries **4 instruments** on the Mothership, and only the **Mothership** is costed
 - This design was **converged down to the actual wet mass**.
- **Option 4** is the same technical design as Option 3, but the cost accounting includes a full project-level roll-up of **all of the elements** in the constellation

Options in this study (#222):

- **Option 5** is a variant on **Option 1**, where the Propellant has been **sized to the actual wet mass**, rather than to the Launch Vehicle allocation
 - This option was created in order to allow a “clean delta” for Option 6
 - It used the re-scalable Propulsion design description from Option 3 of study #2328
- **Option 6** is a variant on **Option 5**, where now the carried **Daughterships have been removed**
- **Option 7** is a variant on **Option 3**, where the carried **Daughterships have been removed**

Cost

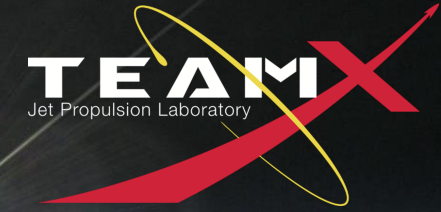

Total Cost (Options 1 & 2)

Option 1

(Reserves: A-D 50% E/F 25%)

COST SUMMARY (FY2025 \$M)	Generate ProPricer Input	Team X Estimate		
		CBE	Res.	PBE
Project Cost		\$1779.8 M	46%	\$2601.4 M
Launch Vehicle		\$0.0 M		\$0.0 M
Project Cost (w/o LV)		\$1779.8 M	46%	\$2601.4 M
Development Cost		\$1531.2 M	50%	\$2296.4 M
Phase A		\$15.3 M	50%	\$23.0 M
Phase B		\$137.8 M	50%	\$206.7 M
Phase C/D		\$1378.1 M	50%	\$2066.8 M
Operations Cost		\$248.6 M	23%	\$305.0 M

Option 2

(Reserves: A-D 50% E/F 25%)

COST SUMMARY (FY2025 \$M)	Generate ProPricer Input	Team X Estimate		
		CBE	Res.	PBE
Project Cost		\$2693.1 M	46%	\$3939.1 M
Launch Vehicle		\$0.0 M		\$0.0 M
Project Cost (w/o LV)		\$2693.1 M	46%	\$3939.1 M
Development Cost		\$2315.5 M	50%	\$3472.9 M
Phase A		\$23.2 M	50%	\$34.7 M
Phase B		\$208.4 M	50%	\$312.6 M
Phase C/D		\$2084.0 M	50%	\$3125.6 M
Operations Cost		\$377.5 M	23%	\$466.2 M

(Reserves: A-D 30% E/F 15%)

COST SUMMARY (FY2025 \$M)	Generate ProPricer Input	Team X Estimate		
		CBE	Res.	PBE
Project Cost		\$1779.8 M	28%	\$2272.8 M
Launch Vehicle		\$0.0 M		\$0.0 M
Project Cost (w/o LV)		\$1779.8 M	28%	\$2272.8 M
Development Cost		\$1531.2 M	30%	\$1990.3 M
Phase A		\$15.3 M	30%	\$19.9 M
Phase B		\$137.8 M	30%	\$179.1 M
Phase C/D		\$1378.1 M	30%	\$1791.3 M
Operations Cost		\$248.6 M	14%	\$282.4 M

(Reserves: A-D 30% E/F 15%)

COST SUMMARY (FY2025 \$M)	Generate ProPricer Input	Team X Estimate		
		CBE	Res.	PBE
Project Cost		\$2693.1 M	28%	\$3440.7 M
Launch Vehicle		\$0.0 M		\$0.0 M
Project Cost (w/o LV)		\$2693.1 M	28%	\$3440.7 M
Development Cost		\$2315.5 M	30%	\$3010.0 M
Phase A		\$23.2 M	30%	\$30.1 M
Phase B		\$208.4 M	30%	\$270.9 M
Phase C/D		\$2084.0 M	30%	\$2709.0 M
Operations Cost		\$377.5 M	14%	\$430.7 M

Cost

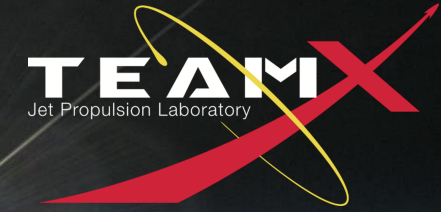

Total Cost (Options 3 & 4)

Option 3

(Reserves: A-D 50% E/F 25%)

COST SUMMARY (FY2025 \$M)	Generate ProPricer Input	Team X Estimate		
		CBE	Res.	PBE
Project Cost		\$967.4 M	45%	\$1401.4 M
Launch Vehicle		\$0.0 M		\$0.0 M
Project Cost (w/o LV)		\$967.4 M	45%	\$1401.4 M
Development Cost		\$793.0 M	50%	\$1189.2 M
Phase A		\$7.9 M	50%	\$11.9 M
Phase B		\$71.4 M	50%	\$107.0 M
Phase C/D		\$713.7 M	50%	\$1070.2 M
Operations Cost		\$174.4 M	22%	\$212.2 M

Option 4

(Reserves: A-D 50% E/F 25%)

COST SUMMARY (FY2025 \$M)	Generate ProPricer Input	Team X Estimate		
		CBE	Res.	PBE
Project Cost		\$1920.3 M	45%	\$2792.3 M
Launch Vehicle		\$0.0 M		\$0.0 M
Project Cost (w/o LV)		\$1920.3 M	45%	\$2792.3 M
Development Cost		\$1592.3 M	50%	\$2388.1 M
Phase A		\$15.9 M	50%	\$23.9 M
Phase B		\$143.3 M	50%	\$214.9 M
Phase C/D		\$1433.1 M	50%	\$2149.3 M
Operations Cost		\$328.0 M	23%	\$404.2 M

(Reserves: A-D 30% E/F 15%)

COST SUMMARY (FY2025 \$M)	Generate ProPricer Input	Team X Estimate		
		CBE	Res.	PBE
Project Cost		\$967.6 M	27%	\$1228.0 M
Launch Vehicle		\$0.0 M		\$0.0 M
Project Cost (w/o LV)		\$967.6 M	27%	\$1228.0 M
Development Cost		\$793.2 M	30%	\$1030.9 M
Phase A		\$7.9 M	30%	\$10.3 M
Phase B		\$71.4 M	30%	\$92.8 M
Phase C/D		\$713.9 M	30%	\$927.8 M
Operations Cost		\$174.4 M	13%	\$197.1 M

(Reserves: A-D 30% E/F 15%)

COST SUMMARY (FY2025 \$M)	Generate ProPricer Input	Team X Estimate		
		CBE	Res.	PBE
Project Cost		\$1920.3 M	27%	\$2443.5 M
Launch Vehicle		\$0.0 M		\$0.0 M
Project Cost (w/o LV)		\$1920.3 M	27%	\$2443.5 M
Development Cost		\$1592.3 M	30%	\$2069.8 M
Phase A		\$15.9 M	30%	\$20.7 M
Phase B		\$143.3 M	30%	\$186.3 M
Phase C/D		\$1433.1 M	30%	\$1862.8 M
Operations Cost		\$328.0 M	14%	\$373.7 M

Cost

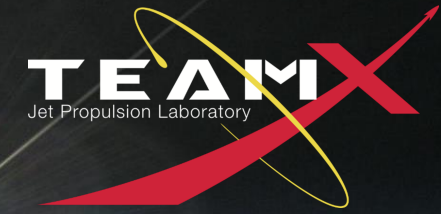

Total Cost (Options 5 & 6)

Option 5

(Reserves: A-D 50% E/F 25%)

COST SUMMARY (FY2025 \$M)	Generate ProPricer Input	Team X Estimate		
		CBE	Res.	PBE
Project Cost		\$1769.8 M	46%	\$2586.5 M
Launch Vehicle		\$0.0 M		\$0.0 M
Project Cost (w/o LV)		\$1769.8 M	46%	\$2586.5 M
Development Cost		\$1521.2 M	50%	\$2281.5 M
Phase A		\$15.2 M	50%	\$22.8 M
Phase B		\$136.9 M	50%	\$205.3 M
Phase C/D		\$1369.1 M	50%	\$2053.3 M
Operations Cost		\$248.6 M	23%	\$305.0 M

Option 6

(Reserves: A-D 50% E/F 25%)

COST SUMMARY (FY2025 \$M)	Generate ProPricer Input	Team X Estimate		
		CBE	Res.	PBE
Project Cost		\$1759.8 M	46%	\$2570.7 M
Launch Vehicle		\$0.0 M		\$0.0 M
Project Cost (w/o LV)		\$1759.8 M	46%	\$2570.7 M
Development Cost		\$1508.2 M	50%	\$2262.0 M
Phase A		\$15.1 M	50%	\$22.6 M
Phase B		\$135.7 M	50%	\$203.6 M
Phase C/D		\$1357.4 M	50%	\$2035.8 M
Operations Cost		\$251.6 M	23%	\$308.7 M

(Reserves: A-D 30% E/F 15%)

COST SUMMARY (FY2025 \$M)	Generate ProPricer Input	Team X Estimate		
		CBE	Res.	PBE
Project Cost		\$1769.8 M	28%	\$2259.8 M
Launch Vehicle		\$0.0 M		\$0.0 M
Project Cost (w/o LV)		\$1769.8 M	28%	\$2259.8 M
Development Cost		\$1521.2 M	30%	\$1977.4 M
Phase A		\$15.2 M	30%	\$19.8 M
Phase B		\$136.9 M	30%	\$178.0 M
Phase C/D		\$1369.1 M	30%	\$1779.7 M
Operations Cost		\$248.6 M	14%	\$282.4 M

(Reserves: A-D 30% E/F 15%)

COST SUMMARY (FY2025 \$M)	Generate ProPricer Input	Team X Estimate		
		CBE	Res.	PBE
Project Cost		\$1759.8 M	28%	\$2246.3 M
Launch Vehicle		\$0.0 M		\$0.0 M
Project Cost (w/o LV)		\$1759.8 M	28%	\$2246.3 M
Development Cost		\$1508.2 M	30%	\$1960.5 M
Phase A		\$15.1 M	30%	\$19.6 M
Phase B		\$135.7 M	30%	\$176.4 M
Phase C/D		\$1357.4 M	30%	\$1764.4 M
Operations Cost		\$251.6 M	14%	\$285.8 M

Total Cost (Option 7)

Option 7

(Reserves: A-D 50% E/F 25%)

COST SUMMARY (FY2025 \$M)	Generate ProPricer Input	Team X Estimate		
		CBE	Res.	PBE
Project Cost		\$953.5 M	45%	\$1380.5 M
Launch Vehicle		\$0.0 M		\$0.0 M
Project Cost (w/o LV)		\$953.5 M	45%	\$1380.5 M
Development Cost		\$779.1 M	50%	\$1168.3 M
Phase A		\$7.8 M	50%	\$11.7 M
Phase B		\$70.1 M	50%	\$105.1 M
Phase C/D		\$701.2 M	50%	\$1051.5 M
Operations Cost		\$174.4 M	22%	\$212.2 M

(Reserves: A-D 30% E/F 15%)

COST SUMMARY (FY2025 \$M)	Generate ProPricer Input	Team X Estimate		
		CBE	Res.	PBE
Project Cost		\$953.5 M	27%	\$1209.7 M
Launch Vehicle		\$0.0 M		\$0.0 M
Project Cost (w/o LV)		\$953.5 M	27%	\$1209.7 M
Development Cost		\$779.1 M	30%	\$1012.6 M
Phase A		\$7.8 M	30%	\$10.1 M
Phase B		\$70.1 M	30%	\$91.1 M
Phase C/D		\$701.2 M	30%	\$911.4 M
Operations Cost		\$174.4 M	13%	\$197.1 M

Cost

Cost A-D (Option 1 – 50% Reserves)

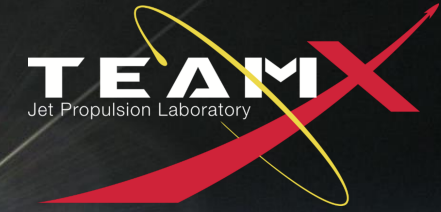

Option 1
Development Cost
(w/ 50% Reserve)
\$2.3B

Development Cost (Phases A - D)	\$1608.7 M	\$687.8 M	\$2296.4 M
01.0 Project Management	\$41.5 M		\$41.5 M
1.01 Project Management	\$17.1 M		\$17.1 M
1.02 Business Management	\$20.5 M		\$20.5 M
1.04 Project Reviews	\$3.5 M		\$3.5 M
1.06 Launch Approval	\$0.4 M		\$0.4 M
02.0 Project Systems Engineering	\$51.3 M	\$3.2 M	\$54.5 M
2.01 Project Systems Engineering	\$13.5 M		\$13.5 M
2.02 Project SW Systems Engineering	\$7.6 M		\$7.6 M
2.03 EEIS	\$0.9 M		\$0.9 M
2.04 Information System Management	\$7.9 M		\$7.9 M
2.05 Configuration Management	\$6.3 M		\$6.3 M
2.06 Planetary Protection	\$1.5 M	\$2.3 M	\$3.8 M
Mothership	\$1.5 M	\$2.3 M	\$3.8 M
2.07 Contamination Control	\$4.1 M	\$0.9 M	\$5.0 M
2.09 Launch System Engineering	\$2.4 M		\$2.4 M
2.10 Project V&V	\$6.4 M		\$6.4 M
2.11 Risk Management	\$0.7 M		\$0.7 M
03.0 Mission Assurance	\$46.5 M	\$19.9 M	\$66.3 M
04.0 Science	\$68.4 M		\$68.4 M
04.01, 04.02, & 04.03 Science Teams	\$68.4 M		\$68.4 M
05.0 Payload System	\$293.0 M	\$196.0 M	\$489.1 M
5.01 Payload Management	\$12.7 M		\$12.7 M
5.02 Payload Engineering	\$9.6 M		\$9.6 M
Element 01	\$270.7 M	\$196.0 M	\$466.7 M
P-Band SAR/Sounder Radar (SMAP)	\$85.4 M	\$61.9 M	\$147.3 M
Visible Imager (MARCI)	\$3.4 M	\$2.5 M	\$5.9 M
Limb Radiometer (Mars Climate Sounder)	\$20.0 M	\$14.5 M	\$34.5 M
Wind LIDAR (MARLI)	\$45.0 M	\$32.6 M	\$77.5 M
Sub-mm Sounder (Mars Compass)	\$33.8 M	\$24.5 M	\$58.3 M
Near IR Spect (Thoth Argus)	\$1.6 M	\$1.2 M	\$2.8 M
Wind Doppler Interferometer (MIGHTI)	\$40.5 M	\$29.4 M	\$69.9 M
FUV/MUV Spect (IUVS-MAVEN)	\$40.9 M	\$29.6 M	\$70.5 M

06.0 Flight System	\$431.0 M	\$234.6 M	\$665.6 M
6.01 Flight System Management	\$7.8 M		\$7.8 M
6.02 Flight System Systems Engineering	\$58.5 M		\$58.5 M
6.03 Product Assurance (included in 3.0)			\$0.0 M
Mothership	\$355.3 M	\$231.5 M	\$586.8 M
6.04 Power	\$22.4 M	\$61.8 M	\$84.2 M
6.05 C&DH	\$46.7 M	\$38.2 M	\$84.9 M
6.06 Telecom	\$42.0 M	\$31.3 M	\$73.4 M
6.07 Structures (includes Mech. I&T)	\$73.5 M	\$18.3 M	\$91.8 M
6.08 Thermal	\$5.1 M	\$6.2 M	\$11.3 M
6.09 Propulsion	\$67.8 M	\$41.1 M	\$108.9 M
6.10 ACS	\$25.3 M	\$18.3 M	\$43.6 M
6.11 Harness	\$15.3 M	\$12.8 M	\$28.1 M
6.12 S/C Software	\$47.9 M	\$2.5 M	\$50.5 M
6.13 Materials and Processes	\$9.3 M	\$1.0 M	\$10.4 M
6.14 Spacecraft Testbeds	\$9.3 M	\$3.1 M	\$12.5 M
07.0 Mission Operations Preparation	\$36.4 M		\$36.4 M
7.0 MOS Teams	\$33.1 M		\$33.1 M
7.03 Tracking (Launch Ops.)	\$0.7 M		\$0.7 M
7.06 Navigation Operations Team	\$2.6 M		\$2.6 M
7.07.03 Mission Planning Team	\$0.0 M		\$0.0 M
09.0 Ground Data Systems	\$39.5 M		\$39.5 M
9.0A Ground Data System	\$34.3 M		\$34.3 M
9.0B Science Data System Development	\$4.2 M		\$4.2 M
9A.03.07 Navigation H/W & S/W Development	\$1.0 M		\$1.0 M
10.0 ATLO	\$35.7 M	\$4.8 M	\$40.5 M
11.0 Education and Public Outreach	\$0.0 M	\$0.0 M	\$0.0 M
12.0 Mission and Navigation Design	\$29.3 M		\$29.3 M
12.01 Mission Design	\$3.2 M		\$3.2 M
12.02 Mission Analysis	\$6.8 M		\$6.8 M
12.03 Mission Engineering	\$7.5 M		\$7.5 M
12.04 Navigation Design	\$11.7 M		\$11.7 M
Development Reserves	\$536.0 M	\$229.3 M	\$765.2 M

Cost

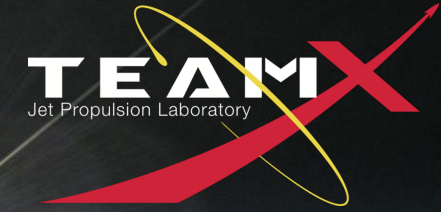

Cost E-F (Option 1 – 25% Reserves)

Option 1
Operations Cost
(w/ 25% Reserve)
\$305M

Operations Cost (Phases E - F)	\$304.8 M	\$0.2 M	\$305.0 M
01.0 Project Management	\$11.7 M		\$11.7 M
1.01 Project Management	\$6.8 M		\$6.8 M
1.02 Business Management	\$4.4 M		\$4.4 M
1.04 Project Reviews	\$0.4 M		\$0.4 M
1.06 Launch Approval	\$0.0 M		\$0.0 M
02.0 Project Systems Engineering	\$0.0 M	\$0.1 M	\$0.2 M
2.06 Planetary Protection	\$0.0 M	\$0.1 M	\$0.2 M
03.0 Mission Assurance	\$4.1 M	\$0.0 M	\$4.1 M
04.0 Science	\$114.5 M		\$114.5 M
4.02 Science Team	\$114.5 M		\$114.5 M
06.0 Flight System	\$0.0 M		\$0.0 M
6.02 Flight System Systems Engineering	\$0.0 M		\$0.0 M
07.0 Mission Operations	\$95.4 M		\$95.4 M
7.0 MOS Teams	\$62.7 M		\$62.7 M
7.03 Tracking	\$23.0 M		\$23.0 M
7.06 Navigation Operations Team	\$9.2 M		\$9.2 M
7.07.03 Mission Planning Team	\$0.5 M		\$0.5 M
09.0 Ground Data Systems	\$22.7 M		\$22.7 M
9.0A GDS Teams	\$10.5 M		\$10.5 M
9.0B Science Data System Ops	\$12.0 M		\$12.0 M
9A.03.07 Navigation HW and SW Dev	\$0.2 M		\$0.2 M
11.0 Education and Public Outreach	\$0.0 M	\$0.0 M	\$0.0 M
12.0 Mission and Navigation Design	\$0.0 M		\$0.0 M
12.01 Mission Design	\$0.0 M		\$0.0 M
12.02 Mission Analysis	\$0.0 M		\$0.0 M
12.04 Navigation Design	\$0.0 M		\$0.0 M
Operations Reserves	\$56.4 M	\$0.0 M	\$56.4 M

Cost

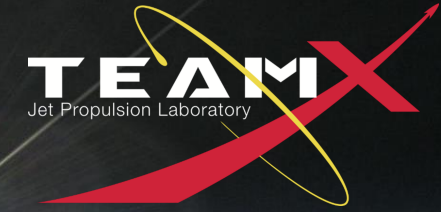

Cost A-D (Option 1 – 30% Reserves)

Option 1
Development Cost
(w/ 30% Reserve)
\$2B

Development Cost (Phases A - D)	\$1394.3 M	\$596.1 M	\$1990.3 M
01.0 Project Management	\$41.5 M		\$41.5 M
1.01 Project Management	\$17.1 M		\$17.1 M
1.02 Business Management	\$20.5 M		\$20.5 M
1.04 Project Reviews	\$3.5 M		\$3.5 M
1.06 Launch Approval	\$0.4 M		\$0.4 M
02.0 Project Systems Engineering	\$51.3 M	\$3.2 M	\$54.5 M
2.01 Project Systems Engineering	\$13.5 M		\$13.5 M
2.02 Project SW Systems Engineering	\$7.6 M		\$7.6 M
2.03 EEIS	\$0.9 M		\$0.9 M
2.04 Information System Management	\$7.9 M		\$7.9 M
2.05 Configuration Management	\$6.3 M		\$6.3 M
2.06 Planetary Protection	\$1.5 M	\$2.3 M	\$3.8 M
Mothership	\$1.5 M	\$2.3 M	\$3.8 M
2.07 Contamination Control	\$4.1 M	\$0.9 M	\$5.0 M
2.09 Launch System Engineering	\$2.4 M		\$2.4 M
2.10 Project V&V	\$6.4 M		\$6.4 M
2.11 Risk Management	\$0.7 M		\$0.7 M
03.0 Mission Assurance	\$46.5 M	\$19.9 M	\$66.3 M
04.0 Science	\$68.4 M		\$68.4 M
04.01, 04.02, & 04.03 Science Teams	\$68.4 M		\$68.4 M
05.0 Payload System	\$293.0 M	\$196.0 M	\$489.1 M
5.01 Payload Management	\$12.7 M		\$12.7 M
5.02 Payload Engineering	\$9.6 M		\$9.6 M
Element 01	\$270.7 M	\$196.0 M	\$466.7 M
P-Band SAR/Sounder Radar (SMAP)	\$85.4 M	\$61.9 M	\$147.3 M
Visible Imager (MARCI)	\$3.4 M	\$2.5 M	\$5.9 M
Limb Radiometer (Mars Climate Sounder)	\$20.0 M	\$14.5 M	\$34.5 M
Wind LIDAR (MARLI)	\$45.0 M	\$32.6 M	\$77.5 M
Sub-mm Sounder (Mars Compass)	\$33.8 M	\$24.5 M	\$58.3 M
Near IR Spect (Thoth Argus)	\$1.6 M	\$1.2 M	\$2.8 M
Wind Doppler Interferometer (MIGHTI)	\$40.5 M	\$29.4 M	\$69.9 M
FUV/MUV Spect (IUVS-MAVEN)	\$40.9 M	\$29.6 M	\$70.5 M

06.0 Flight System	\$431.0 M	\$234.6 M	\$665.6 M
6.01 Flight System Management	\$7.8 M		\$7.8 M
6.02 Flight System Systems Engineering	\$58.5 M		\$58.5 M
6.03 Product Assurance (included in 3.0)			\$0.0 M
Mothership	\$355.3 M	\$231.5 M	\$586.8 M
6.04 Power	\$22.4 M	\$61.8 M	\$84.2 M
6.05 C&DH	\$46.7 M	\$38.2 M	\$84.9 M
6.06 Telecom	\$42.0 M	\$31.3 M	\$73.4 M
6.07 Structures (includes Mech. I&T)	\$73.5 M	\$18.3 M	\$91.8 M
6.08 Thermal	\$5.1 M	\$6.2 M	\$11.3 M
6.09 Propulsion	\$67.8 M	\$41.1 M	\$108.9 M
6.10 ACS	\$25.3 M	\$18.3 M	\$43.6 M
6.11 Harness	\$15.3 M	\$12.8 M	\$28.1 M
6.12 S/C Software	\$47.9 M	\$2.5 M	\$50.5 M
6.13 Materials and Processes	\$9.3 M	\$1.0 M	\$10.4 M
6.14 Spacecraft Testbeds	\$9.3 M	\$3.1 M	\$12.5 M
07.0 Mission Operations Preparation	\$36.4 M		\$36.4 M
7.0 MOS Teams	\$33.1 M		\$33.1 M
7.03 Tracking (Launch Ops.)	\$0.7 M		\$0.7 M
7.06 Navigation Operations Team	\$2.6 M		\$2.6 M
7.07.03 Mission Planning Team	\$0.0 M		\$0.0 M
09.0 Ground Data Systems	\$39.5 M		\$39.5 M
9.0A Ground Data System	\$34.3 M		\$34.3 M
9.0B Science Data System Development	\$4.2 M		\$4.2 M
9A.03.07 Navigation H/W & S/W Development	\$1.0 M		\$1.0 M
10.0 ATLO	\$35.7 M	\$4.8 M	\$40.5 M
11.0 Education and Public Outreach	\$0.0 M	\$0.0 M	\$0.0 M
12.0 Mission and Navigation Design	\$29.3 M		\$29.3 M
12.01 Mission Design	\$3.2 M		\$3.2 M
12.02 Mission Analysis	\$6.8 M		\$6.8 M
12.03 Mission Engineering	\$7.5 M		\$7.5 M
12.04 Navigation Design	\$11.7 M		\$11.7 M
Development Reserves	\$321.6 M	\$137.6 M	\$459.1 M

Cost

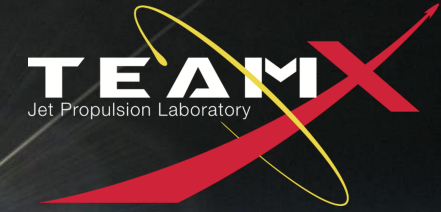

Cost E-F (Option 1 – 15% Reserves)

Option 1
Operations Cost
(w/ 15% Reserve)
\$282M

Operations Cost (Phases E - F)	\$282.3 M	\$0.2 M	\$282.4 M
01.0 Project Management	\$11.7 M		\$11.7 M
1.01 Project Management	\$6.8 M		\$6.8 M
1.02 Business Management	\$4.4 M		\$4.4 M
1.04 Project Reviews	\$0.4 M		\$0.4 M
1.06 Launch Approval	\$0.0 M		\$0.0 M
02.0 Project Systems Engineering	\$0.0 M	\$0.1 M	\$0.2 M
2.06 Planetary Protection	\$0.0 M	\$0.1 M	\$0.2 M
03.0 Mission Assurance	\$4.1 M	\$0.0 M	\$4.1 M
04.0 Science	\$114.5 M		\$114.5 M
4.02 Science Team	\$114.5 M		\$114.5 M
06.0 Flight System	\$0.0 M		\$0.0 M
6.02 Flight System Systems Engineering	\$0.0 M		\$0.0 M
07.0 Mission Operations	\$95.4 M		\$95.4 M
7.0 MOS Teams	\$62.7 M		\$62.7 M
7.03 Tracking	\$23.0 M		\$23.0 M
7.06 Navigation Operations Team	\$9.2 M		\$9.2 M
7.07.03 Mission Planning Team	\$0.5 M		\$0.5 M
09.0 Ground Data Systems	\$22.7 M		\$22.7 M
9.0A GDS Teams	\$10.5 M		\$10.5 M
9.0B Science Data System Ops	\$12.0 M		\$12.0 M
9A.03.07 Navigation HW and SW Dev	\$0.2 M		\$0.2 M
11.0 Education and Public Outreach	\$0.0 M	\$0.0 M	\$0.0 M
12.0 Mission and Navigation Design	\$0.0 M		\$0.0 M
12.01 Mission Design	\$0.0 M		\$0.0 M
12.02 Mission Analysis	\$0.0 M		\$0.0 M
12.04 Navigation Design	\$0.0 M		\$0.0 M
Operations Reserves	\$33.8 M	\$0.0 M	\$33.8 M

Cost

Cost A-D (Option 2 – 50% Reserves)

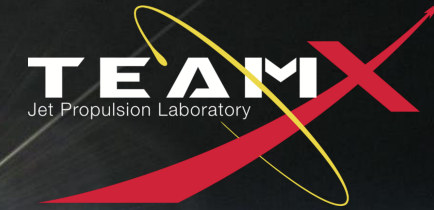

Option 2
Development Cost
(w/ 50% Reserve)
\$3.47B

Development Cost (Phases A - D)	\$2643.4 M	\$829.5 M	\$3472.9 M
01.0 Project Management	\$41.5 M		\$41.5 M
1.01 Project Management	\$17.1 M		\$17.1 M
1.02 Business Management	\$20.5 M		\$20.5 M
1.04 Project Reviews	\$3.5 M		\$3.5 M
1.06 Launch Approval	\$0.4 M		\$0.4 M
02.0 Project Systems Engineering	\$92.9 M	\$5.9 M	\$98.8 M
2.01 Project Systems Engineering	\$32.1 M		\$32.1 M
2.02 Project SW Systems Engineering	\$9.6 M		\$9.6 M
2.03 EEIS	\$7.8 M		\$7.8 M
2.04 Information System Management	\$7.9 M		\$7.9 M
2.05 Configuration Management	\$9.6 M		\$9.6 M
2.06 Planetary Protection	\$5.4 M	\$5.0 M	\$10.4 M
MotherShip	\$1.5 M	\$2.3 M	\$3.8 M
Polar	\$1.3 M	\$1.8 M	\$3.1 M
Elliptical	\$1.3 M	\$0.9 M	\$2.2 M
Areo Mothership + SmallSats	\$1.3 M		\$1.3 M
2.07 Contamination Control	\$4.1 M	\$0.9 M	\$5.0 M
2.09 Launch System Engineering	\$2.4 M		\$2.4 M
2.10 Project V&V	\$5.8 M		\$5.8 M
2.11 Risk Management	\$8.3 M		\$8.3 M
03.0 Mission Assurance	\$75.4 M	\$23.7 M	\$99.1 M
04.0 Science	\$80.7 M		\$80.7 M
05.0 Payload System	\$476.3 M	\$210.5 M	\$686.8 M
5.01 Payload Management	\$60.2 M		\$60.2 M
5.02 Payload Engineering	\$54.9 M		\$54.9 M
MotherShip	\$270.7 M	\$196.0 M	\$466.7 M
Polar	\$8.4 M	\$6.9 M	\$15.3 M
Elliptical	\$18.9 M	\$7.5 M	\$26.4 M
Areo Mothership	\$55.7 M	\$0.0 M	\$55.7 M
Areo SmallSats	\$7.6 M	\$0.0 M	\$7.6 M
06.0 Flight System	\$679.1 M	\$302.3 M	\$981.4 M
6.01 Flight System Management	\$22.3 M		\$22.3 M
6.01A Mothership	\$7.8 M		\$7.8 M
6.01B Polar	\$2.9 M		\$2.9 M
6.01C Elliptical	\$2.7 M		\$2.7 M
6.01D Areo Mothership + SmallSats	\$8.8 M		\$8.8 M
6.02 Flight System Systems Engineering	\$73.7 M		\$73.7 M
6.01A Mothership	\$59.7 M		\$59.7 M
6.01B Polar	\$2.9 M		\$2.9 M
6.01C Elliptical	\$2.6 M		\$2.6 M
6.01D Areo Mothership + SmallSats	\$8.6 M		\$8.6 M

Mothership	\$355.3 M	\$231.5 M	\$586.8 M
6.04 Power	\$22.4 M	\$61.8 M	\$84.2 M
6.05 C&DH	\$46.7 M	\$38.2 M	\$84.9 M
6.06 Telecom	\$42.0 M	\$31.3 M	\$73.4 M
6.07 Structures (includes Mech. I&T)	\$73.5 M	\$18.3 M	\$91.8 M
6.08 Thermal	\$5.1 M	\$6.2 M	\$11.3 M
6.09 Propulsion	\$67.8 M	\$41.1 M	\$108.9 M
6.10 ACS	\$25.3 M	\$18.3 M	\$43.6 M
6.11 Harness	\$15.3 M	\$12.8 M	\$28.1 M
6.12 S/C Software	\$47.9 M	\$2.5 M	\$50.5 M
6.13 Materials and Processes	\$9.3 M	\$1.0 M	\$10.4 M
Polar	\$28.7 M	\$29.2 M	\$57.9 M
Elliptical	\$38.1 M	\$14.9 M	\$53.0 M
Areo Mothership	\$121.2 M	\$0.0 M	\$121.2 M
Areo SmallSats	\$28.6 M	\$22.9 M	\$51.5 M
6.14 Spacecraft Testbeds	\$11.3 M	\$3.8 M	\$15.0 M
07.0 Mission Operations Preparation	\$77.1 M		\$77.1 M
07A.0 Mothership + Polar + Elliptical	\$53.4 M		\$53.4 M
7A.0 MOS Teams	\$48.9 M		\$48.9 M
7A.03 Tracking (Launch Ops.)	\$0.7 M		\$0.7 M
7A.06 Navigation Operations Team	\$3.7 M		\$3.7 M
7A.07.03 Mission Planning Team	\$0.0 M		\$0.0 M
07B.0 Areo Mothership + SmallSats	\$23.7 M		\$23.7 M
09.0 Ground Data Systems	\$81.8 M		\$81.8 M
09A.0 Mothership + Polar + Elliptical	\$54.6 M		\$54.6 M
9.0A Ground Data System	\$44.8 M		\$44.8 M
9.0B Science Data System Development	\$8.8 M		\$8.8 M
9A.03.07 Navigation H/W & S/W Development	\$0.9 M		\$0.9 M
09B.0 Areo Mothership + SmallSats	\$27.2 M		\$27.2 M
10.0 ATLO	\$64.8 M	\$10.7 M	\$75.4 M
Mothership	\$31.8 M	\$4.8 M	\$36.5 M
Polar	\$3.6 M	\$3.6 M	\$7.2 M
Elliptical	\$5.7 M	\$2.3 M	\$8.0 M
Areo Mothership + SmallSats	\$23.7 M	\$0.0 M	\$23.7 M
11.0 Education and Public Outreach	\$0.0 M	\$0.0 M	\$0.0 M
12.0 Mission and Navigation Design	\$92.9 M		\$92.9 M
12A.0 Mothership	\$38.1 M		\$38.1 M
12A.01 Mission Design	\$2.9 M		\$2.9 M
12A.02 Mission Analysis	\$9.9 M		\$9.9 M
12A.03 Mission Engineering	\$6.7 M		\$6.7 M
12A.04 Navigation Design	\$18.6 M		\$18.6 M
12B.0 Polar	\$15.2 M		\$15.2 M
12C.0 Elliptical	\$13.2 M		\$13.2 M
12D.0 Areo Mothership + SmallSats	\$26.4 M		\$26.4 M
Development Reserves	\$880.9 M	\$276.5 M	\$1157.4 M

Cost

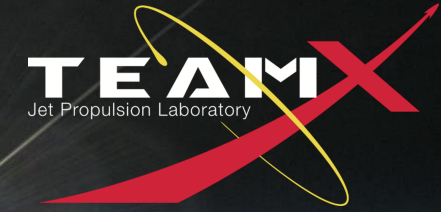

Cost E-F (Option 2 – 25% Reserves)

Option 2
Operations Cost
(w/ 25% Reserve)
\$466M

Operations Cost (Phases E - F)	\$466.0 M	\$0.2 M	\$466.2 M
01.0 Project Management	\$11.7 M		\$11.7 M
1.01 Project Management	\$6.8 M		\$6.8 M
1.02 Business Management	\$4.4 M		\$4.4 M
1.04 Project Reviews	\$0.4 M		\$0.4 M
1.06 Launch Approval	\$0.0 M		\$0.0 M
02.0 Project Systems Engineering	\$0.0 M	\$0.1 M	\$0.2 M
2.06 Planetary Protection	\$0.0 M	\$0.1 M	\$0.2 M
03.0 Mission Assurance	\$0.0 M	\$0.0 M	\$0.0 M
04.0 Science	\$119.7 M		\$119.7 M
4A.02 Mothership Science Team	\$114.5 M		\$114.5 M
4B.02 Polar Science Team	\$1.0 M		\$1.0 M
4C.02 Elliptical Science Team	\$1.1 M		\$1.1 M
4D.02 Areo Mothership + SmallSats Science Team	\$3.2 M		\$3.2 M
06.0 Flight System	\$0.0 M		\$0.0 M
6.02 Flight System Systems Engineering	\$0.0 M		\$0.0 M
07.0 Mission Operations	\$193.1 M		\$193.1 M
07A.0 Mothership + Polar + Elliptical	\$149.7 M		\$149.7 M
7A.0 MOS Teams	\$117.0 M		\$117.0 M
7A.03 Tracking	\$23.0 M		\$23.0 M
7A.06 Navigation Operations Team	\$9.2 M		\$9.2 M
7A.07.03 Mission Planning Team	\$0.6 M		\$0.6 M
07B.0 Areo Mothership + SmallSats	\$43.4 M		\$43.4 M
09.0 Ground Data Systems	\$52.8 M		\$52.8 M
09A.0 Mothership + Polar + Elliptical	\$37.9 M		\$151.8 M
9.0A GDS Teams	\$12.5 M		\$12.5 M
9.0B Science Data System Ops	\$25.2 M		\$25.2 M
9A.03.07 Navigation HW and SW Dev	\$0.2 M		\$0.2 M
09B.0 Areo Mothership + SmallSats	\$14.9 M		\$14.9 M
11.0 Education and Public Outreach	\$0.0 M	\$0.0 M	\$0.0 M
12.0 Mission and Navigation Design	\$0.0 M		\$0.0 M
12.01 Mission Design	\$0.0 M		\$0.0 M
12.02 Mission Analysis	\$0.0 M		\$0.0 M
12.04 Navigation Design	\$0.0 M		\$0.0 M
Operations Reserves	\$88.6 M	\$0.0 M	\$88.6 M

Cost

Cost A-D (Option 2 – 30% Reserves)

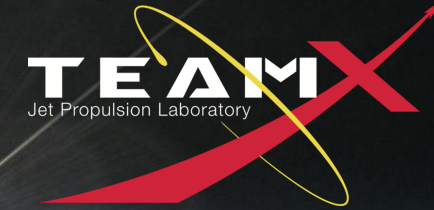

Option 2
Development Cost
(w/ 30% Reserve)

\$3B

Development Cost (Phases A - D)	\$2291.0 M	\$718.9 M	\$3010.0 M
01.0 Project Management	\$41.5 M		\$41.5 M
1.01 Project Management	\$17.1 M		\$17.1 M
1.02 Business Management	\$20.5 M		\$20.5 M
1.04 Project Reviews	\$3.5 M		\$3.5 M
1.06 Launch Approval	\$0.4 M		\$0.4 M
02.0 Project Systems Engineering	\$92.9 M	\$5.9 M	\$98.8 M
2.01 Project Systems Engineering	\$32.1 M		\$32.1 M
2.02 Project SW Systems Engineering	\$9.6 M		\$9.6 M
2.03 EEIS	\$7.8 M		\$7.8 M
2.04 Information System Management	\$7.9 M		\$7.9 M
2.05 Configuration Management	\$9.6 M		\$9.6 M
2.06 Planetary Protection	\$5.4 M	\$5.0 M	\$10.4 M
MotherShip	\$1.5 M	\$2.3 M	\$3.8 M
Polar	\$1.3 M	\$1.8 M	\$3.1 M
Elliptical	\$1.3 M	\$0.9 M	\$2.2 M
Areo Mothership + SmallSats	\$1.3 M		\$1.3 M
2.07 Contamination Control	\$4.1 M	\$0.9 M	\$5.0 M
2.09 Launch System Engineering	\$2.4 M		\$2.4 M
2.10 Project V&V	\$5.8 M		\$5.8 M
2.11 Risk Management	\$8.3 M		\$8.3 M
03.0 Mission Assurance	\$75.4 M	\$23.7 M	\$99.1 M
04.0 Science	\$80.7 M		\$80.7 M
05.0 Payload System	\$476.3 M	\$210.5 M	\$686.8 M
5.01 Payload Management	\$60.2 M		\$60.2 M
5.02 Payload Engineering	\$54.9 M		\$54.9 M
MotherShip	\$270.7 M	\$196.0 M	\$466.7 M
Polar	\$8.4 M	\$6.9 M	\$15.3 M
Elliptical	\$18.9 M	\$7.5 M	\$26.4 M
Areo Mothership	\$55.7 M	\$0.0 M	\$55.7 M
Areo SmallSats	\$7.6 M	\$0.0 M	\$7.6 M
06.0 Flight System	\$679.1 M	\$302.3 M	\$981.4 M
6.01 Flight System Management	\$22.3 M		\$22.3 M
6.01A Mothership	\$7.8 M		\$7.8 M
6.01B Polar	\$2.9 M		\$2.9 M
6.01C Elliptical	\$2.7 M		\$2.7 M
6.01D Areo Mothership + SmallSats	\$8.8 M		\$8.8 M
6.02 Flight System Systems Engineering	\$73.7 M		\$73.7 M
6.01A Mothership	\$59.7 M		\$59.7 M
6.01B Polar	\$2.9 M		\$2.9 M
6.01C Elliptical	\$2.6 M		\$2.6 M
6.01D Areo Mothership + SmallSats	\$8.6 M		\$8.6 M

Mothership	\$355.3 M	\$231.5 M	\$586.8 M
6.04 Power	\$22.4 M	\$61.8 M	\$84.2 M
6.05 C&DH	\$46.7 M	\$38.2 M	\$84.9 M
6.06 Telecom	\$42.0 M	\$31.3 M	\$73.4 M
6.07 Structures (includes Mech. I&T)	\$73.5 M	\$18.3 M	\$91.8 M
6.08 Thermal	\$5.1 M	\$6.2 M	\$11.3 M
6.09 Propulsion	\$67.8 M	\$41.1 M	\$108.9 M
6.10 ACS	\$25.3 M	\$18.3 M	\$43.6 M
6.11 Harness	\$15.3 M	\$12.8 M	\$28.1 M
6.12 S/C Software	\$47.9 M	\$2.5 M	\$50.5 M
6.13 Materials and Processes	\$9.3 M	\$1.0 M	\$10.4 M
Polar	\$28.7 M	\$29.2 M	\$57.9 M
Elliptical	\$38.1 M	\$14.9 M	\$53.0 M
Areo Mothership	\$121.2 M	\$0.0 M	\$121.2 M
Areo SmallSats	\$28.6 M	\$22.9 M	\$51.5 M
6.14 Spacecraft Testbeds	\$11.3 M	\$3.8 M	\$15.0 M
07.0 Mission Operations Preparation	\$77.1 M		\$77.1 M
07A.0 Mothership + Polar + Elliptical	\$53.4 M		\$53.4 M
7A.0 MOS Teams	\$48.9 M		\$48.9 M
7A.03 Tracking (Launch Ops.)	\$0.7 M		\$0.7 M
7A.06 Navigation Operations Team	\$3.7 M		\$3.7 M
7A.07.03 Mission Planning Team	\$0.0 M		\$0.0 M
07B.0 Areo Mothership + SmallSats	\$23.7 M		\$23.7 M
09.0 Ground Data Systems	\$81.8 M		\$81.8 M
09A.0 Mothership + Polar + Elliptical	\$54.6 M		\$54.6 M
9.0A Ground Data System	\$44.8 M		\$44.8 M
9.0B Science Data System Development	\$8.8 M		\$8.8 M
9A.03.07 Navigation H/W & S/W Development	\$0.9 M		\$0.9 M
09B.0 Areo Mothership + SmallSats	\$27.2 M		\$27.2 M
10.0 ATLO	\$64.8 M	\$10.7 M	\$75.4 M
Mothership	\$31.8 M	\$4.8 M	\$36.5 M
Polar	\$3.6 M	\$3.6 M	\$7.2 M
Elliptical	\$5.7 M	\$2.3 M	\$8.0 M
Areo Mothership + SmallSats	\$23.7 M	\$0.0 M	\$23.7 M
11.0 Education and Public Outreach	\$0.0 M	\$0.0 M	\$0.0 M
12.0 Mission and Navigation Design	\$92.9 M		\$92.9 M
12A.0 Mothership	\$38.1 M		\$38.1 M
12A.01 Mission Design	\$2.9 M		\$2.9 M
12A.02 Mission Analysis	\$9.9 M		\$9.9 M
12A.03 Mission Engineering	\$6.7 M		\$6.7 M
12A.04 Navigation Design	\$18.6 M		\$18.6 M
12B.0 Polar	\$15.2 M		\$15.2 M
12C.0 Elliptical	\$13.2 M		\$13.2 M
12D.0 Areo Mothership + SmallSats	\$26.4 M		\$26.4 M
Development Reserves	\$528.5 M	\$165.9 M	\$694.4 M

Cost

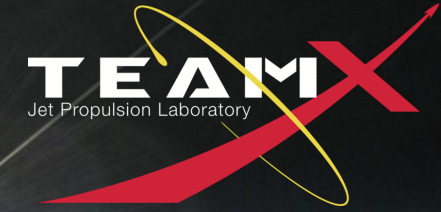

Cost E-F (Option 2 – 15% Reserves)

Option 2
Operations Cost
(w/ 15% Reserve)
\$430M

Operations Cost (Phases E - F)	\$430.6 M	\$0.2 M	\$430.7 M
01.0 Project Management	\$11.7 M		\$11.7 M
1.01 Project Management	\$6.8 M		\$6.8 M
1.02 Business Management	\$4.4 M		\$4.4 M
1.04 Project Reviews	\$0.4 M		\$0.4 M
1.06 Launch Approval	\$0.0 M		\$0.0 M
02.0 Project Systems Engineering	\$0.0 M	\$0.1 M	\$0.2 M
2.06 Planetary Protection	\$0.0 M	\$0.1 M	\$0.2 M
03.0 Mission Assurance	\$0.0 M	\$0.0 M	\$0.0 M
04.0 Science	\$119.7 M		\$119.7 M
4A.02 Mothership Science Team	\$114.5 M		\$114.5 M
4B.02 Polar Science Team	\$1.0 M		\$1.0 M
4C.02 Elliptical Science Team	\$1.1 M		\$1.1 M
4D.02 Areo Mothership + SmallSats Science Team	\$3.2 M		\$3.2 M
06.0 Flight System	\$0.0 M		\$0.0 M
6.02 Flight System Systems Engineering	\$0.0 M		\$0.0 M
07.0 Mission Operations	\$193.1 M		\$193.1 M
07A.0 Mothership + Polar + Elliptical	\$149.7 M		\$149.7 M
7A.0 MOS Teams	\$117.0 M		\$117.0 M
7A.03 Tracking	\$23.0 M		\$23.0 M
7A.06 Navigation Operations Team	\$9.2 M		\$9.2 M
7A.07.03 Mission Planning Team	\$0.6 M		\$0.6 M
07B.0 Areo Mothership + SmallSats	\$43.4 M		\$43.4 M
09.0 Ground Data Systems	\$52.8 M		\$52.8 M
09A.0 Mothership + Polar + Elliptical	\$37.9 M		\$151.8 M
9.0A GDS Teams	\$12.5 M		\$12.5 M
9.0B Science Data System Ops	\$25.2 M		\$25.2 M
9A.03.07 Navigation HW and SW Dev	\$0.2 M		\$0.2 M
09B.0 Areo Mothership + SmallSats	\$14.9 M		\$14.9 M
11.0 Education and Public Outreach	\$0.0 M	\$0.0 M	\$0.0 M
12.0 Mission and Navigation Design	\$0.0 M		\$0.0 M
12.01 Mission Design	\$0.0 M		\$0.0 M
12.02 Mission Analysis	\$0.0 M		\$0.0 M
12.04 Navigation Design	\$0.0 M		\$0.0 M
Operations Reserves	\$53.2 M	\$0.0 M	\$53.2 M

Cost

Cost A-D (Option 3 – 50% Reserves)

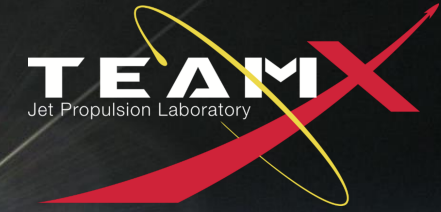

Option 3
Development Cost
(w/ 50% Reserve)
\$1.2B

Development Cost (Phases A - D)	\$820.5 M	\$368.7 M	\$1189.2 M
01.0 Project Management	\$21.0 M		\$21.0 M
1.01 Project Management	\$8.9 M		\$8.9 M
1.02 Business Management	\$10.2 M		\$10.2 M
1.04 Project Reviews	\$1.4 M		\$1.4 M
1.06 Launch Approval	\$0.4 M		\$0.4 M
02.0 Project Systems Engineering	\$25.9 M	\$2.9 M	\$28.7 M
2.01 Project Systems Engineering	\$8.9 M		\$8.9 M
2.02 Project SW Systems Engineering	\$5.2 M		\$5.2 M
2.03 EEIS	\$0.6 M		\$0.6 M
2.04 Information System Management	\$1.7 M		\$1.7 M
2.05 Configuration Management	\$1.6 M		\$1.6 M
2.06 Planetary Protection	\$1.5 M	\$2.3 M	\$3.8 M
Mothership	\$1.5 M	\$2.3 M	\$3.8 M
2.07 Contamination Control	\$2.6 M	\$0.6 M	\$3.2 M
2.09 Launch System Engineering	\$1.1 M		\$1.1 M
2.10 Project V&V	\$2.2 M		\$2.2 M
2.11 Risk Management	\$0.5 M		\$0.5 M
03.0 Mission Assurance	\$22.6 M	\$10.1 M	\$32.7 M
04.0 Science	\$21.0 M		\$21.0 M
04.01, 04.02, & 04.03 Science Teams	\$21.0 M		\$21.0 M
05.0 Payload System	\$73.4 M	\$47.8 M	\$121.1 M
5.01 Payload Management	\$4.3 M		\$4.3 M
5.02 Payload Engineering	\$3.1 M		\$3.1 M
Element 01	\$65.9 M	\$47.8 M	\$113.7 M
Visible Imager (MARCI)	\$3.4 M	\$2.5 M	\$5.9 M
Limb Radiometer (Mars Climate Sounder)	\$20.0 M	\$14.5 M	\$34.5 M
Near IR Spect (Thoth Argus)	\$1.6 M	\$1.2 M	\$2.8 M
FUV/MUV Spect (IUVS-MAVEN)	\$40.9 M	\$29.6 M	\$70.5 M

06.0 Flight System	\$290.0 M	\$180.4 M	\$470.4 M
6.01 Flight System Management	\$5.2 M		\$5.2 M
6.02 Flight System Systems Engineering	\$35.8 M		\$35.8 M
6.03 Product Assurance (included in 3.0)			\$0.0 M
Element 01	\$241.6 M	\$177.9 M	\$419.6 M
6.04 Power	\$15.8 M	\$48.6 M	\$64.3 M
6.05 C&DH	\$20.2 M	\$35.1 M	\$55.3 M
6.06 Telecom	\$36.4 M	\$24.1 M	\$60.5 M
6.07 Structures (includes Mech. I&T)	\$42.1 M	\$12.9 M	\$55.1 M
6.08 Thermal	\$3.6 M	\$4.2 M	\$7.8 M
6.09 Propulsion	\$59.4 M	\$30.8 M	\$90.2 M
6.10 ACS	\$18.1 M	\$15.3 M	\$33.4 M
6.11 Harness	\$4.6 M	\$4.5 M	\$9.1 M
6.12 S/C Software	\$37.7 M	\$2.0 M	\$39.7 M
6.13 Materials and Processes	\$3.8 M	\$0.4 M	\$4.2 M
6.14 Spacecraft Testbeds	\$7.4 M	\$2.5 M	\$9.8 M
07.0 Mission Operations Preparation	\$28.1 M		\$28.1 M
7.0 MOS Teams	\$25.2 M		\$25.2 M
7.03 Tracking (Launch Ops.)	\$0.7 M		\$0.7 M
7.06 Navigation Operations Team	\$2.2 M		\$2.2 M
7.07.03 Mission Planning Team	\$0.0 M		\$0.0 M
09.0 Ground Data Systems	\$23.6 M		\$23.6 M
9.0A Ground Data System	\$20.5 M		\$20.5 M
9.0B Science Data System Development	\$2.1 M		\$2.1 M
9A.03.07 Navigation H/W & S/W Development	\$1.0 M		\$1.0 M
10.0 ATLO	\$24.3 M	\$4.6 M	\$28.9 M
11.0 Education and Public Outreach	\$0.0 M	\$0.0 M	\$0.0 M
12.0 Mission and Navigation Design	\$17.4 M		\$17.4 M
12.01 Mission Design	\$2.2 M		\$2.2 M
12.02 Mission Analysis	\$5.0 M		\$5.0 M
12.03 Mission Engineering	\$1.8 M		\$1.8 M
12.04 Navigation Design	\$8.4 M		\$8.4 M
Development Reserves	\$273.2 M	\$122.9 M	\$396.1 M

Cost

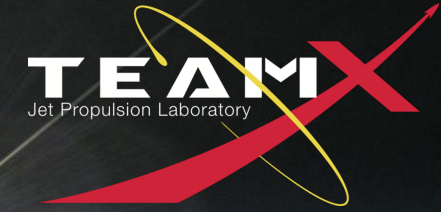

Cost E-F (Option 3 – 25% Reserves)

Option 3
Operations Cost
(w/ 25% Reserve)
\$212M

Operations Cost (Phases E - F)	\$212.0 M	\$0.2 M	\$212.2 M
01.0 Project Management	\$7.3 M		\$7.3 M
1.01 Project Management	\$4.3 M		\$4.3 M
1.02 Business Management	\$2.9 M		\$2.9 M
1.04 Project Reviews	\$0.2 M		\$0.2 M
1.06 Launch Approval	\$0.0 M		\$0.0 M
02.0 Project Systems Engineering	\$0.0 M	\$0.1 M	\$0.2 M
2.06 Planetary Protection	\$0.0 M	\$0.1 M	\$0.2 M
03.0 Mission Assurance	\$4.1 M	\$0.0 M	\$4.1 M
04.0 Science	\$52.7 M		\$52.7 M
4.02 Science Team	\$52.7 M		\$52.7 M
06.0 Flight System	\$0.0 M		\$0.0 M
07.0 Mission Operations	\$94.7 M		\$94.7 M
7.0 MOS Teams	\$62.0 M		\$62.0 M
7.03 Tracking	\$23.0 M		\$23.0 M
7.06 Navigation Operations Team	\$9.2 M		\$9.2 M
7.07.03 Mission Planning Team	\$0.5 M		\$0.5 M
09.0 Ground Data Systems	\$15.4 M		\$15.4 M
9.0A GDS Teams	\$9.2 M		\$9.2 M
9.0B Science Data System Ops	\$6.0 M		\$6.0 M
9A.03.07 Navigation HW and SW Dev	\$0.2 M		\$0.2 M
11.0 Education and Public Outreach	\$0.0 M	\$0.0 M	\$0.0 M
12.0 Mission and Navigation Design	\$0.0 M		\$0.0 M
Operations Reserves	\$37.8 M	\$0.0 M	\$37.8 M

Cost

Cost A-D (Option 3 – 30% Reserves)

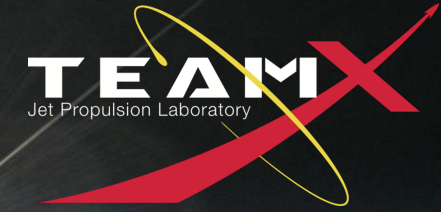

Option 3
Development Cost
(w/ 30% Reserve)
\$1B

Development Cost (Phases A - D)	\$711.3 M	\$319.6 M	\$1030.9 M
01.0 Project Management	\$21.0 M		\$21.0 M
1.01 Project Management	\$8.9 M		\$8.9 M
1.02 Business Management	\$10.2 M		\$10.2 M
1.04 Project Reviews	\$1.4 M		\$1.4 M
1.06 Launch Approval	\$0.4 M		\$0.4 M
02.0 Project Systems Engineering	\$25.9 M	\$2.9 M	\$28.7 M
2.01 Project Systems Engineering	\$8.9 M		\$8.9 M
2.02 Project SW Systems Engineering	\$5.2 M		\$5.2 M
2.03 EEIS	\$0.6 M		\$0.6 M
2.04 Information System Management	\$1.7 M		\$1.7 M
2.05 Configuration Management	\$1.6 M		\$1.6 M
2.06 Planetary Protection	\$1.5 M	\$2.3 M	\$3.8 M
Mothership	\$1.5 M	\$2.3 M	\$3.8 M
2.07 Contamination Control	\$2.6 M	\$0.6 M	\$3.2 M
2.09 Launch System Engineering	\$1.1 M		\$1.1 M
2.10 Project V&V	\$2.2 M		\$2.2 M
2.11 Risk Management	\$0.5 M		\$0.5 M
03.0 Mission Assurance	\$22.7 M	\$10.2 M	\$32.9 M
04.0 Science	\$21.0 M		\$21.0 M
04.01, 04.02, & 04.03 Science Teams	\$21.0 M		\$21.0 M
05.0 Payload System	\$73.4 M	\$47.8 M	\$121.1 M
5.01 Payload Management	\$4.3 M		\$4.3 M
5.02 Payload Engineering	\$3.1 M		\$3.1 M
Element 01	\$65.9 M	\$47.8 M	\$113.7 M
Visible Imager (MARCI)	\$3.4 M	\$2.5 M	\$5.9 M
Limb Radiometer (Mars Climate Sounder)	\$20.0 M	\$14.5 M	\$34.5 M
Near IR Spect (Thoth Argus)	\$1.6 M	\$1.2 M	\$2.8 M
FUV/MUV Spect (IUVS-MAVEN)	\$40.9 M	\$29.6 M	\$70.5 M

06.0 Flight System	\$290.0 M	\$180.4 M	\$470.4 M
6.01 Flight System Management	\$5.2 M		\$5.2 M
6.02 Flight System Systems Engineering	\$35.8 M		\$35.8 M
6.03 Product Assurance (included in 3.0)			\$0.0 M
Element 01	\$241.6 M	\$177.9 M	\$419.6 M
6.04 Power	\$15.8 M	\$48.6 M	\$64.3 M
6.05 C&DH	\$20.2 M	\$35.1 M	\$55.3 M
6.06 Telecom	\$36.4 M	\$24.1 M	\$60.5 M
6.07 Structures (includes Mech. I&T)	\$42.1 M	\$12.9 M	\$55.1 M
6.08 Thermal	\$3.6 M	\$4.2 M	\$7.8 M
6.09 Propulsion	\$59.4 M	\$30.8 M	\$90.2 M
6.10 ACS	\$18.1 M	\$15.3 M	\$33.4 M
6.11 Harness	\$4.6 M	\$4.5 M	\$9.1 M
6.12 S/C Software	\$37.7 M	\$2.0 M	\$39.7 M
6.13 Materials and Processes	\$3.8 M	\$0.4 M	\$4.2 M
6.14 Spacecraft Testbeds	\$7.4 M	\$2.5 M	\$9.8 M
07.0 Mission Operations Preparation	\$28.1 M		\$28.1 M
7.0 MOS Teams	\$25.2 M		\$25.2 M
7.03 Tracking (Launch Ops.)	\$0.7 M		\$0.7 M
7.06 Navigation Operations Team	\$2.2 M		\$2.2 M
7.07.03 Mission Planning Team	\$0.0 M		\$0.0 M
09.0 Ground Data Systems	\$23.6 M		\$23.6 M
9.0A Ground Data System	\$20.5 M		\$20.5 M
9.0B Science Data System Development	\$2.1 M		\$2.1 M
9A.03.07 Navigation H/W & S/W Development	\$1.0 M		\$1.0 M
10.0 ATLO	\$24.3 M	\$4.6 M	\$28.9 M
11.0 Education and Public Outreach	\$0.0 M	\$0.0 M	\$0.0 M
12.0 Mission and Navigation Design	\$17.4 M		\$17.4 M
12.01 Mission Design	\$2.2 M		\$2.2 M
12.02 Mission Analysis	\$5.0 M		\$5.0 M
12.03 Mission Engineering	\$1.8 M		\$1.8 M
12.04 Navigation Design	\$8.4 M		\$8.4 M
Development Reserves	\$164.0 M	\$73.8 M	\$237.7 M

Cost

Cost E-F (Option 3 – 15% Reserves)

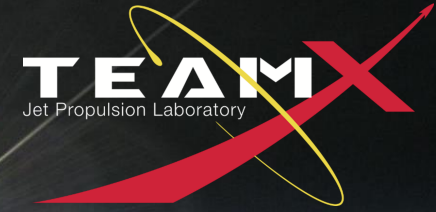

Option 3
Operations Cost
(w/ 15% Reserve)
\$197M

Operations Cost (Phases E - F)	\$196.9 M	\$0.2 M	\$197.1 M
01.0 Project Management	\$7.3 M		\$7.3 M
1.01 Project Management	\$4.3 M		\$4.3 M
1.02 Business Management	\$2.9 M		\$2.9 M
1.04 Project Reviews	\$0.2 M		\$0.2 M
1.06 Launch Approval	\$0.0 M		\$0.0 M
02.0 Project Systems Engineering	\$0.0 M	\$0.1 M	\$0.2 M
2.06 Planetary Protection	\$0.0 M	\$0.1 M	\$0.2 M
03.0 Mission Assurance	\$4.1 M	\$0.0 M	\$4.1 M
04.0 Science	\$52.7 M		\$52.7 M
4.02 Science Team	\$52.7 M		\$52.7 M
06.0 Flight System	\$0.0 M		\$0.0 M
07.0 Mission Operations	\$94.7 M		\$94.7 M
7.0 MOS Teams	\$62.0 M		\$62.0 M
7.03 Tracking	\$23.0 M		\$23.0 M
7.06 Navigation Operations Team	\$9.2 M		\$9.2 M
7.07.03 Mission Planning Team	\$0.5 M		\$0.5 M
09.0 Ground Data Systems	\$15.4 M		\$15.4 M
9.0A GDS Teams	\$9.2 M		\$9.2 M
9.0B Science Data System Ops	\$6.0 M		\$6.0 M
9A.03.07 Navigation HW and SW Dev	\$0.2 M		\$0.2 M
11.0 Education and Public Outreach	\$0.0 M	\$0.0 M	\$0.0 M
12.0 Mission and Navigation Design	\$0.0 M		\$0.0 M
Operations Reserves	\$22.7 M	\$0.0 M	\$22.7 M

Cost

Cost A-D (Option 4 – 50% Reserves)

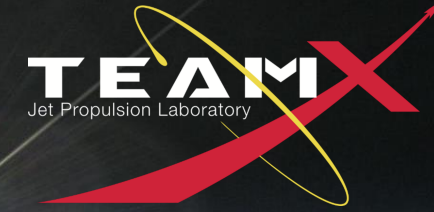

Option 4
Development Cost
(w/ 50% Reserve)
\$2.4B

Development Cost (Phases A - D)	\$1878.1 M	\$510.0 M	\$2388.1 M
01.0 Project Management	\$30.4 M		\$30.4 M
1.01 Project Management	\$12.6 M		\$12.6 M
1.02 Business Management	\$14.8 M		\$14.8 M
1.04 Project Reviews	\$2.6 M		\$2.6 M
1.06 Launch Approval	\$0.4 M		\$0.4 M
02.0 Project Systems Engineering	\$68.4 M	\$5.6 M	\$74.0 M
2.01 Project Systems Engineering	\$23.4 M		\$23.4 M
2.02 Project SW Systems Engineering	\$6.8 M		\$6.8 M
2.03 EEIS	\$5.4 M		\$5.4 M
2.04 Information System Management	\$5.7 M		\$5.7 M
2.05 Configuration Management	\$6.9 M		\$6.9 M
2.06 Planetary Protection	\$5.4 M	\$5.0 M	\$10.4 M
MotherShip	\$1.5 M	\$2.3 M	\$3.8 M
Polar	\$1.3 M	\$1.8 M	\$3.1 M
Elliptical	\$1.3 M	\$0.9 M	\$2.2 M
Areo Mothership + SmallSats	\$1.3 M		\$1.3 M
2.07 Contamination Control	\$2.6 M	\$0.6 M	\$3.2 M
2.09 Launch System Engineering	\$1.7 M		\$1.7 M
2.10 Project V&V	\$4.5 M		\$4.5 M
2.11 Risk Management	\$6.1 M		\$6.1 M
03.0 Mission Assurance	\$51.2 M	\$13.9 M	\$65.0 M
04.0 Science	\$33.3 M		\$33.3 M
05.0 Payload System	\$231.9 M	\$62.2 M	\$294.1 M
5.01 Payload Management	\$39.3 M		\$39.3 M
5.02 Payload Engineering	\$36.1 M		\$36.1 M
MotherShip	\$65.9 M	\$47.8 M	\$113.7 M
Polar	\$8.4 M	\$6.9 M	\$15.3 M
Elliptical	\$18.9 M	\$7.5 M	\$26.4 M
Areo Mothership	\$55.7 M	\$0.0 M	\$55.7 M
Areo SmallSats	\$7.6 M	\$0.0 M	\$7.6 M
06.0 Flight System	\$542.1 M	\$247.7 M	\$789.8 M
6.01 Flight System Management	\$20.1 M		\$20.1 M
6.01A Mothership	\$5.7 M		\$5.7 M
6.01B Polar	\$2.9 M		\$2.9 M
6.01C Elliptical	\$2.7 M		\$2.7 M
6.01D Areo Mothership + SmallSats	\$8.8 M		\$8.8 M
6.02 Flight System Systems Engineering	\$55.6 M		\$55.6 M
6.01A Mothership	\$41.5 M		\$41.5 M
6.01B Polar	\$2.9 M		\$2.9 M
6.01C Elliptical	\$2.6 M		\$2.6 M
6.01D Areo Mothership + SmallSats	\$8.6 M		\$8.6 M

Mothership	\$241.6 M	\$177.9 M	\$419.6 M
6.04 Power	\$15.8 M	\$48.6 M	\$64.3 M
6.05 C&DH	\$20.2 M	\$35.1 M	\$55.3 M
6.06 Telecom	\$36.4 M	\$24.1 M	\$60.5 M
6.07 Structures (includes Mech. I&T)	\$42.1 M	\$12.9 M	\$55.1 M
6.08 Thermal	\$3.6 M	\$4.2 M	\$7.8 M
6.09 Propulsion	\$59.4 M	\$30.8 M	\$90.2 M
6.10 ACS	\$18.1 M	\$15.3 M	\$33.4 M
6.11 Harness	\$4.6 M	\$4.5 M	\$9.1 M
6.12 S/C Software	\$37.7 M	\$2.0 M	\$39.7 M
6.13 Materials and Processes	\$3.8 M	\$0.4 M	\$4.2 M
Polar	\$28.7 M	\$29.2 M	\$57.9 M
Elliptical	\$38.1 M	\$14.9 M	\$53.0 M
Areo Mothership	\$121.2 M	\$0.0 M	\$121.2 M
Areo SmallSats	\$28.6 M	\$22.9 M	\$51.5 M
6.14 Spacecraft Testbeds	\$8.3 M	\$2.8 M	\$11.0 M
07.0 Mission Operations Preparation	\$72.4 M		\$72.4 M
07A.0 Mothership + Polar + Elliptical	\$48.7 M		\$48.7 M
7A.0 MOS Teams	\$43.8 M		\$43.8 M
7A.03 Tracking (Launch Ops.)	\$0.7 M		\$0.7 M
7A.06 Navigation Operations Team	\$4.2 M		\$4.2 M
7A.07.03 Mission Planning Team	\$0.0 M		\$0.0 M
07B.0 Areo Mothership + SmallSats	\$23.7 M		\$23.7 M
09.0 Ground Data Systems	\$75.0 M		\$75.0 M
09A.0 Mothership + Polar + Elliptical	\$47.8 M		\$47.8 M
9.0A Ground Data System	\$39.5 M		\$39.5 M
9.0B Science Data System Development	\$7.3 M		\$7.3 M
9A.03.07 Navigation H/W & S/W Development	\$1.0 M		\$1.0 M
09B.0 Areo Mothership + SmallSats	\$27.2 M		\$27.2 M
10.0 ATLO	\$61.6 M	\$10.6 M	\$72.2 M
Mothership	\$28.6 M	\$4.7 M	\$33.3 M
Polar	\$3.6 M	\$3.6 M	\$7.2 M
Elliptical	\$5.7 M	\$2.3 M	\$8.0 M
Areo Mothership + SmallSats	\$23.7 M	\$0.0 M	\$23.7 M
11.0 Education and Public Outreach	\$0.0 M	\$0.0 M	\$0.0 M
12.0 Mission and Navigation Design	\$86.0 M		\$86.0 M
12A.0 Mothership	\$31.2 M		\$31.2 M
12A.01 Mission Design	\$2.4 M		\$2.4 M
12A.02 Mission Analysis	\$8.6 M		\$8.6 M
12A.03 Mission Engineering	\$5.4 M		\$5.4 M
12A.04 Navigation Design	\$14.9 M		\$14.9 M
12B.0 Polar	\$15.2 M		\$15.2 M
12C.0 Elliptical	\$13.2 M		\$13.2 M
12D.0 Areo Mothership + SmallSats	\$26.4 M		\$26.4 M
Development Reserves	\$625.8 M	\$170.0 M	\$795.8 M

Cost

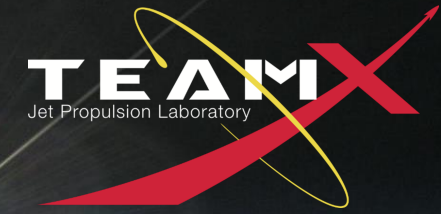

Cost E-F (Option 4 – 25% Reserves)

Option 4
Operations Cost
(w/ 25% Reserve)
\$404M

Operations Cost (Phases E - F)	\$404.0 M	\$0.2 M	\$404.2 M
01.0 Project Management	\$11.7 M		\$11.7 M
1.01 Project Management	\$6.8 M		\$6.8 M
1.02 Business Management	\$4.4 M		\$4.4 M
1.04 Project Reviews	\$0.4 M		\$0.4 M
1.06 Launch Approval	\$0.0 M		\$0.0 M
02.0 Project Systems Engineering	\$0.0 M	\$0.1 M	\$0.2 M
2.06 Planetary Protection	\$0.0 M	\$0.1 M	\$0.2 M
03.0 Mission Assurance	\$0.0 M	\$0.0 M	\$0.0 M
04.0 Science	\$58.0 M		\$58.0 M
4A.02 Mothership Science Team	\$52.7 M		\$52.7 M
4B.02 Polar Science Team	\$1.0 M		\$1.0 M
4C.02 Elliptical Science Team	\$1.1 M		\$1.1 M
4D.02 Areo Mothership + SmallSats Science Team	\$3.2 M		\$3.2 M
06.0 Flight System	\$0.0 M		\$0.0 M
6.02 Flight System Systems Engineering	\$0.0 M		\$0.0 M
07.0 Mission Operations	\$208.3 M		\$208.3 M
07A.0 Mothership + Polar + Elliptical	\$164.9 M		\$164.9 M
7A.0 MOS Teams	\$131.1 M		\$131.1 M
7A.03 Tracking	\$23.0 M		\$23.0 M
7A.06 Navigation Operations Team	\$10.2 M		\$10.2 M
7A.07.03 Mission Planning Team	\$0.6 M		\$0.6 M
07B.0 Areo Mothership + SmallSats	\$43.4 M		\$43.4 M
09.0 Ground Data Systems	\$49.9 M		\$49.9 M
09A.0 Mothership + Polar + Elliptical	\$35.0 M		\$139.9 M
9.0A GDS Teams	\$13.8 M		\$13.8 M
9.0B Science Data System Ops	\$20.9 M		\$20.9 M
9A.03.07 Navigation HW and SW Dev	\$0.2 M		\$0.2 M
09B.0 Areo Mothership + SmallSats	\$14.9 M		\$14.9 M
11.0 Education and Public Outreach	\$0.0 M	\$0.0 M	\$0.0 M
12.0 Mission and Navigation Design	\$0.0 M		\$0.0 M
12.01 Mission Design	\$0.0 M		\$0.0 M
12.02 Mission Analysis	\$0.0 M		\$0.0 M
12.04 Navigation Design	\$0.0 M		\$0.0 M
Operations Reserves	\$76.2 M	\$0.0 M	\$76.2 M

Cost

Cost A-D (Option 4 – 30% Reserves)

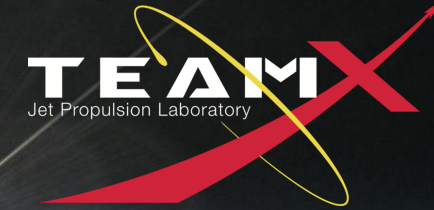

Option 4
Development Cost
(w/ 30% Reserve)

\$2B

Development Cost (Phases A - D)	\$1627.8 M	\$442.0 M	\$2069.8 M
01.0 Project Management	\$30.4 M		\$30.4 M
1.01 Project Management	\$12.6 M		\$12.6 M
1.02 Business Management	\$14.8 M		\$14.8 M
1.04 Project Reviews	\$2.6 M		\$2.6 M
1.06 Launch Approval	\$0.4 M		\$0.4 M
02.0 Project Systems Engineering	\$68.4 M	\$5.6 M	\$74.0 M
2.01 Project Systems Engineering	\$23.4 M		\$23.4 M
2.02 Project SW Systems Engineering	\$6.8 M		\$6.8 M
2.03 EEIS	\$5.4 M		\$5.4 M
2.04 Information System Management	\$5.7 M		\$5.7 M
2.05 Configuration Management	\$6.9 M		\$6.9 M
2.06 Planetary Protection	\$5.4 M	\$5.0 M	\$10.4 M
MotherShip	\$1.5 M	\$2.3 M	\$3.8 M
Polar	\$1.3 M	\$1.8 M	\$3.1 M
Elliptical	\$1.3 M	\$0.9 M	\$2.2 M
Areo Mothership + SmallSats	\$1.3 M		\$1.3 M
2.07 Contamination Control	\$2.6 M	\$0.6 M	\$3.2 M
2.09 Launch System Engineering	\$1.7 M		\$1.7 M
2.10 Project V&V	\$4.5 M		\$4.5 M
2.11 Risk Management	\$6.1 M		\$6.1 M
03.0 Mission Assurance	\$51.2 M	\$13.9 M	\$65.0 M
04.0 Science	\$33.3 M		\$33.3 M
05.0 Payload System	\$231.9 M	\$62.2 M	\$294.1 M
5.01 Payload Management	\$39.3 M		\$39.3 M
5.02 Payload Engineering	\$36.1 M		\$36.1 M
MotherShip	\$65.9 M	\$47.8 M	\$113.7 M
Polar	\$8.4 M	\$6.9 M	\$15.3 M
Elliptical	\$18.9 M	\$7.5 M	\$26.4 M
Areo Mothership	\$55.7 M	\$0.0 M	\$55.7 M
Areo SmallSats	\$7.6 M	\$0.0 M	\$7.6 M
06.0 Flight System	\$542.1 M	\$247.7 M	\$789.8 M
6.01 Flight System Management	\$20.1 M		\$20.1 M
6.01A Mothership	\$5.7 M		\$5.7 M
6.01B Polar	\$2.9 M		\$2.9 M
6.01C Elliptical	\$2.7 M		\$2.7 M
6.01D Areo Mothership + SmallSats	\$8.8 M		\$8.8 M
6.02 Flight System Systems Engineering	\$55.6 M		\$55.6 M
6.01A Mothership	\$41.5 M		\$41.5 M
6.01B Polar	\$2.9 M		\$2.9 M
6.01C Elliptical	\$2.6 M		\$2.6 M
6.01D Areo Mothership + SmallSats	\$8.6 M		\$8.6 M

Mothership	\$241.6 M	\$177.9 M	\$419.6 M
6.04 Power	\$15.8 M	\$48.6 M	\$64.3 M
6.05 C&DH	\$20.2 M	\$35.1 M	\$55.3 M
6.06 Telecom	\$36.4 M	\$24.1 M	\$60.5 M
6.07 Structures (includes Mech. I&T)	\$42.1 M	\$12.9 M	\$55.1 M
6.08 Thermal	\$3.6 M	\$4.2 M	\$7.8 M
6.09 Propulsion	\$59.4 M	\$30.8 M	\$90.2 M
6.10 ACS	\$18.1 M	\$15.3 M	\$33.4 M
6.11 Harness	\$4.6 M	\$4.5 M	\$9.1 M
6.12 S/C Software	\$37.7 M	\$2.0 M	\$39.7 M
6.13 Materials and Processes	\$3.8 M	\$0.4 M	\$4.2 M
Polar	\$28.7 M	\$29.2 M	\$57.9 M
Elliptical	\$38.1 M	\$14.9 M	\$53.0 M
Areo Mothership	\$121.2 M	\$0.0 M	\$121.2 M
Areo SmallSats	\$28.6 M	\$22.9 M	\$51.5 M
6.14 Spacecraft Testbeds	\$8.3 M	\$2.8 M	\$11.0 M
07.0 Mission Operations Preparation	\$72.4 M		\$72.4 M
07A.0 Mothership + Polar + Elliptical	\$48.7 M		\$48.7 M
7A.0 MOS Teams	\$43.8 M		\$43.8 M
7A.03 Tracking (Launch Ops.)	\$0.7 M		\$0.7 M
7A.06 Navigation Operations Team	\$4.2 M		\$4.2 M
7A.07.03 Mission Planning Team	\$0.0 M		\$0.0 M
07B.0 Areo Mothership + SmallSats	\$23.7 M		\$23.7 M
09.0 Ground Data Systems	\$75.0 M		\$75.0 M
09A.0 Mothership + Polar + Elliptical	\$47.8 M		\$47.8 M
9.0A Ground Data System	\$39.5 M		\$39.5 M
9.0B Science Data System Development	\$7.3 M		\$7.3 M
9A.03.07 Navigation H/W & S/W Development	\$1.0 M		\$1.0 M
09B.0 Areo Mothership + SmallSats	\$27.2 M		\$27.2 M
10.0 ATLO	\$61.6 M	\$10.6 M	\$72.2 M
Mothership	\$28.6 M	\$4.7 M	\$33.3 M
Polar	\$3.6 M	\$3.6 M	\$7.2 M
Elliptical	\$5.7 M	\$2.3 M	\$8.0 M
Areo Mothership + SmallSats	\$23.7 M	\$0.0 M	\$23.7 M
11.0 Education and Public Outreach	\$0.0 M	\$0.0 M	\$0.0 M
12.0 Mission and Navigation Design	\$86.0 M		\$86.0 M
12A.0 Mothership	\$31.2 M		\$31.2 M
12A.01 Mission Design	\$2.4 M		\$2.4 M
12A.02 Mission Analysis	\$8.6 M		\$8.6 M
12A.03 Mission Engineering	\$5.4 M		\$5.4 M
12A.04 Navigation Design	\$14.9 M		\$14.9 M
12B.0 Polar	\$15.2 M		\$15.2 M
12C.0 Elliptical	\$13.2 M		\$13.2 M
12D.0 Areo Mothership + SmallSats	\$26.4 M		\$26.4 M
Development Reserves	\$375.5 M	\$102.0 M	\$477.5 M

Cost

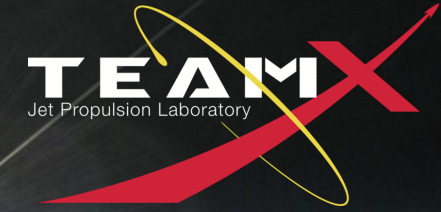

Cost E-F (Option 4 – 15% Reserves)

Option 4
Operations Cost
(w/ 15% Reserve)
\$374M

Operations Cost (Phases E - F)	\$373.6 M	\$0.2 M	\$373.7 M
01.0 Project Management	\$11.7 M		\$11.7 M
1.01 Project Management	\$6.8 M		\$6.8 M
1.02 Business Management	\$4.4 M		\$4.4 M
1.04 Project Reviews	\$0.4 M		\$0.4 M
1.06 Launch Approval	\$0.0 M		\$0.0 M
02.0 Project Systems Engineering	\$0.0 M	\$0.1 M	\$0.2 M
2.06 Planetary Protection	\$0.0 M	\$0.1 M	\$0.2 M
03.0 Mission Assurance	\$0.0 M	\$0.0 M	\$0.0 M
04.0 Science	\$58.0 M		\$58.0 M
4A.02 Mothership Science Team	\$52.7 M		\$52.7 M
4B.02 Polar Science Team	\$1.0 M		\$1.0 M
4C.02 Elliptical Science Team	\$1.1 M		\$1.1 M
4D.02 Areo Mothership + SmallSats Scier	\$3.2 M		\$3.2 M
06.0 Flight System	\$0.0 M		\$0.0 M
6.02 Flight System Systems Engineering	\$0.0 M		\$0.0 M
07.0 Mission Operations	\$208.3 M		\$208.3 M
07A.0 Mothership + Polar + Elliptical	\$164.9 M		\$164.9 M
7A.0 MOS Teams	\$131.1 M		\$131.1 M
7A.03 Tracking	\$23.0 M		\$23.0 M
7A.06 Navigation Operations Team	\$10.2 M		\$10.2 M
7A.07.03 Mission Planning Team	\$0.6 M		\$0.6 M
07B.0 Areo Mothership + SmallSats	\$43.4 M		\$43.4 M
09.0 Ground Data Systems	\$49.9 M		\$49.9 M
09A.0 Mothership + Polar + Elliptical	\$35.0 M		\$139.9 M
9.0A GDS Teams	\$13.8 M		\$13.8 M
9.0B Science Data System Ops	\$20.9 M		\$20.9 M
9A.03.07 Navigation HW and SW Dev	\$0.2 M		\$0.2 M
09B.0 Areo Mothership + SmallSats	\$14.9 M		\$14.9 M
11.0 Education and Public Outreach	\$0.0 M	\$0.0 M	\$0.0 M
12.0 Mission and Navigation Design	\$0.0 M		\$0.0 M
12.01 Mission Design	\$0.0 M		\$0.0 M
12.02 Mission Analysis	\$0.0 M		\$0.0 M
12.04 Navigation Design	\$0.0 M		\$0.0 M
Operations Reserves	\$45.7 M	\$0.0 M	\$45.7 M

Cost

Cost A-D (Option 5 – 50% Reserves)

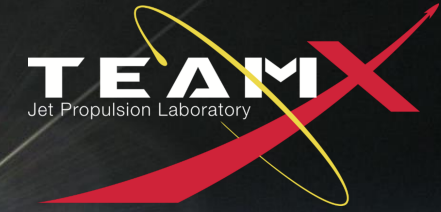

Option 5
Development Cost
(w/ 50% Reserve)
\$2.28B

Development Cost (Phases A - D)	\$1606.4 M	\$675.1 M	\$2281.5 M
01.0 Project Management	\$41.5 M		\$41.5 M
1.01 Project Management	\$17.1 M		\$17.1 M
1.02 Business Management	\$20.5 M		\$20.5 M
1.04 Project Reviews	\$3.5 M		\$3.5 M
1.06 Launch Approval	\$0.4 M		\$0.4 M
02.0 Project Systems Engineering	\$51.3 M	\$3.2 M	\$54.5 M
2.01 Project Systems Engineering	\$13.5 M		\$13.5 M
2.02 Project SW Systems Engineering	\$7.6 M		\$7.6 M
2.03 EEIS	\$0.9 M		\$0.9 M
2.04 Information System Management	\$7.9 M		\$7.9 M
2.05 Configuration Management	\$6.3 M		\$6.3 M
2.06 Planetary Protection	\$1.5 M	\$2.3 M	\$3.8 M
Mothership	\$1.5 M	\$2.3 M	\$3.8 M
2.07 Contamination Control	\$4.1 M	\$0.9 M	\$5.0 M
2.09 Launch System Engineering	\$2.4 M		\$2.4 M
2.10 Project V&V	\$6.4 M		\$6.4 M
2.11 Risk Management	\$0.7 M		\$0.7 M
03.0 Mission Assurance	\$46.4 M	\$19.5 M	\$65.9 M
04.0 Science	\$68.4 M		\$68.4 M
04.01, 04.02, & 04.03 Science Teams	\$68.4 M		\$68.4 M
05.0 Payload System	\$293.0 M	\$196.0 M	\$489.1 M
5.01 Payload Management	\$12.7 M		\$12.7 M
5.02 Payload Engineering	\$9.6 M		\$9.6 M
Element 01	\$270.7 M	\$196.0 M	\$466.7 M
P-Band SAR/Sounder Radar (SMAP)	\$85.4 M	\$61.9 M	\$147.3 M
Visible Imager (MARCI)	\$3.4 M	\$2.5 M	\$5.9 M
Limb Radiometer (Mars Climate Sounder)	\$20.0 M	\$14.5 M	\$34.5 M
Wind LIDAR (MARLI)	\$45.0 M	\$32.6 M	\$77.5 M
Sub-mm Sounder (Mars Compass)	\$33.8 M	\$24.5 M	\$58.3 M
Near IR Spect (Thoth Argus)	\$1.6 M	\$1.2 M	\$2.8 M
Wind Doppler Interferometer (MIGHTI)	\$40.5 M	\$29.4 M	\$69.9 M
FUV/MUV Spect (IUVS-MAVEN)	\$40.9 M	\$29.6 M	\$70.5 M

06.0 Flight System	\$429.5 M	\$226.6 M	\$656.1 M
6.01 Flight System Management	\$7.8 M		\$7.8 M
6.02 Flight System Systems Engineering	\$58.5 M		\$58.5 M
6.03 Product Assurance (included in 3.0)			\$0.0 M
Mothership	\$353.8 M	\$223.4 M	\$577.3 M
6.04 Power	\$22.4 M	\$55.0 M	\$77.5 M
6.05 C&DH	\$46.7 M	\$38.2 M	\$84.9 M
6.06 Telecom	\$42.0 M	\$31.3 M	\$73.4 M
6.07 Structures (includes Mech. I&T)	\$72.4 M	\$17.8 M	\$90.2 M
6.08 Thermal	\$5.1 M	\$6.2 M	\$11.3 M
6.09 Propulsion	\$67.4 M	\$40.2 M	\$107.7 M
6.10 ACS	\$25.3 M	\$18.3 M	\$43.6 M
6.11 Harness	\$15.3 M	\$12.8 M	\$28.1 M
6.12 S/C Software	\$47.9 M	\$2.5 M	\$50.5 M
6.13 Materials and Processes	\$9.3 M	\$1.0 M	\$10.4 M
6.14 Spacecraft Testbeds	\$9.3 M	\$3.1 M	\$12.5 M
07.0 Mission Operations Preparation	\$36.4 M		\$36.4 M
7.0 MOS Teams	\$33.1 M		\$33.1 M
7.03 Tracking (Launch Ops.)	\$0.7 M		\$0.7 M
7.06 Navigation Operations Team	\$2.6 M		\$2.6 M
7.07.03 Mission Planning Team	\$0.0 M		\$0.0 M
09.0 Ground Data Systems	\$39.5 M		\$39.5 M
9.0A Ground Data System	\$34.3 M		\$34.3 M
9.0B Science Data System Development	\$4.2 M		\$4.2 M
9A.03.07 Navigation H/W & S/W Development	\$1.0 M		\$1.0 M
10.0 ATLO	\$35.7 M	\$4.8 M	\$40.5 M
11.0 Education and Public Outreach	\$0.0 M	\$0.0 M	\$0.0 M
12.0 Mission and Navigation Design	\$29.3 M		\$29.3 M
12.01 Mission Design	\$3.2 M		\$3.2 M
12.02 Mission Analysis	\$6.8 M		\$6.8 M
12.03 Mission Engineering	\$7.5 M		\$7.5 M
12.04 Navigation Design	\$11.7 M		\$11.7 M
Development Reserves	\$535.2 M	\$225.0 M	\$760.2 M

Cost

Cost E-F (Option 5 – 25% Reserves)

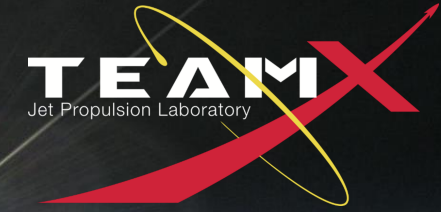

Option 5
Operations Cost
(w/ 25% Reserve)
\$305M

Operations Cost (Phases E - F)	\$304.8 M	\$0.2 M	\$305.0 M
01.0 Project Management	\$11.7 M		\$11.7 M
1.01 Project Management	\$6.8 M		\$6.8 M
1.02 Business Management	\$4.4 M		\$4.4 M
1.04 Project Reviews	\$0.4 M		\$0.4 M
02.0 Project Systems Engineering	\$0.0 M	\$0.1 M	\$0.2 M
2.06 Planetary Protection	\$0.0 M	\$0.1 M	\$0.2 M
03.0 Mission Assurance	\$4.1 M	\$0.0 M	\$4.1 M
04.0 Science	\$114.5 M		\$114.5 M
4.02 Science Team	\$114.5 M		\$114.5 M
06.0 Flight System	\$0.0 M		\$0.0 M
07.0 Mission Operations	\$95.4 M		\$95.4 M
7.0 MOS Teams	\$62.7 M		\$62.7 M
7.03 Tracking	\$23.0 M		\$23.0 M
7.06 Navigation Operations Team	\$9.2 M		\$9.2 M
7.07.03 Mission Planning Team	\$0.5 M		\$0.5 M
09.0 Ground Data Systems	\$22.7 M		\$22.7 M
9.0A GDS Teams	\$10.5 M		\$10.5 M
9.0B Science Data System Ops	\$12.0 M		\$12.0 M
9A.03.07 Navigation HW and SW Dev	\$0.2 M		\$0.2 M
11.0 Education and Public Outreach	\$0.0 M	\$0.0 M	\$0.0 M
12.0 Mission and Navigation Design	\$0.0 M		\$0.0 M
Operations Reserves	\$56.4 M	\$0.0 M	\$56.4 M

Cost

Cost A-D (Option 5 – 30% Reserves)

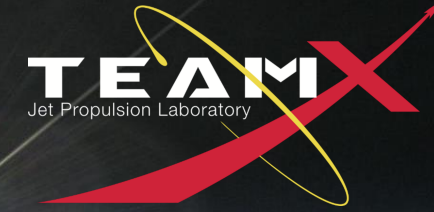

Option 5
Development Cost
(w/ 30% Reserve)
\$1.98B

Development Cost (Phases A - D)	\$1392.3 M	\$585.1 M	\$1977.4 M	06.0 Flight System	\$429.5 M	\$226.6 M	\$656.1 M
01.0 Project Management	\$41.5 M		\$41.5 M	6.01 Flight System Management	\$7.8 M		\$7.8 M
1.01 Project Management	\$17.1 M		\$17.1 M	6.02 Flight System Systems Engineering	\$58.5 M		\$58.5 M
1.02 Business Management	\$20.5 M		\$20.5 M	6.03 Product Assurance (included in 3.0)			\$0.0 M
1.04 Project Reviews	\$3.5 M		\$3.5 M	Mothership	\$353.8 M	\$223.4 M	\$577.3 M
1.06 Launch Approval	\$0.4 M		\$0.4 M	6.04 Power	\$22.4 M	\$55.0 M	\$77.5 M
02.0 Project Systems Engineering	\$51.3 M	\$3.2 M	\$54.5 M	6.05 C&DH	\$46.7 M	\$38.2 M	\$84.9 M
2.01 Project Systems Engineering	\$13.5 M		\$13.5 M	6.06 Telecom	\$42.0 M	\$31.3 M	\$73.4 M
2.02 Project SW Systems Engineering	\$7.6 M		\$7.6 M	6.07 Structures (includes Mech. I&T)	\$72.4 M	\$17.8 M	\$90.2 M
2.03 EEIS	\$0.9 M		\$0.9 M	6.08 Thermal	\$5.1 M	\$6.2 M	\$11.3 M
2.04 Information System Management	\$7.9 M		\$7.9 M	6.09 Propulsion	\$67.4 M	\$40.2 M	\$107.7 M
2.05 Configuration Management	\$6.3 M		\$6.3 M	6.10 ACS	\$25.3 M	\$18.3 M	\$43.6 M
2.06 Planetary Protection	\$1.5 M	\$2.3 M	\$3.8 M	6.11 Harness	\$15.3 M	\$12.8 M	\$28.1 M
Mothership	\$1.5 M	\$2.3 M	\$3.8 M	6.12 S/C Software	\$47.9 M	\$2.5 M	\$50.5 M
2.07 Contamination Control	\$4.1 M	\$0.9 M	\$5.0 M	6.13 Materials and Processes	\$9.3 M	\$1.0 M	\$10.4 M
2.09 Launch System Engineering	\$2.4 M		\$2.4 M	6.14 Spacecraft Testbeds	\$9.3 M	\$3.1 M	\$12.5 M
2.10 Project V&V	\$6.4 M		\$6.4 M	07.0 Mission Operations Preparation	\$36.4 M		\$36.4 M
2.11 Risk Management	\$0.7 M		\$0.7 M	7.0 MOS Teams	\$33.1 M		\$33.1 M
03.0 Mission Assurance	\$46.4 M	\$19.5 M	\$65.9 M	7.03 Tracking (Launch Ops.)	\$0.7 M		\$0.7 M
04.0 Science	\$68.4 M		\$68.4 M	7.06 Navigation Operations Team	\$2.6 M		\$2.6 M
04.01, 04.02, & 04.03 Science Teams	\$68.4 M		\$68.4 M	7.07.03 Mission Planning Team	\$0.0 M		\$0.0 M
05.0 Payload System	\$293.0 M	\$196.0 M	\$489.1 M	09.0 Ground Data Systems	\$39.5 M		\$39.5 M
5.01 Payload Management	\$12.7 M		\$12.7 M	9.0A Ground Data System	\$34.3 M		\$34.3 M
5.02 Payload Engineering	\$9.6 M		\$9.6 M	9.0B Science Data System Development	\$4.2 M		\$4.2 M
Element 01	\$270.7 M	\$196.0 M	\$466.7 M	9A.03.07 Navigation H/W & S/W Development	\$1.0 M		\$1.0 M
P-Band SAR/Sounder Radar (SMAP)	\$85.4 M	\$61.9 M	\$147.3 M	10.0 ATLO	\$35.7 M	\$4.8 M	\$40.5 M
Visible Imager (MARCI)	\$3.4 M	\$2.5 M	\$5.9 M	11.0 Education and Public Outreach	\$0.0 M	\$0.0 M	\$0.0 M
Limb Radiometer (Mars Climate Sounder)	\$20.0 M	\$14.5 M	\$34.5 M	12.0 Mission and Navigation Design	\$29.3 M		\$29.3 M
Wind LIDAR (MARLI)	\$45.0 M	\$32.6 M	\$77.5 M	12.01 Mission Design	\$3.2 M		\$3.2 M
Sub-mm Sounder (Mars Compass)	\$33.8 M	\$24.5 M	\$58.3 M	12.02 Mission Analysis	\$6.8 M		\$6.8 M
Near IR Spect (Thoth Argus)	\$1.6 M	\$1.2 M	\$2.8 M	12.03 Mission Engineering	\$7.5 M		\$7.5 M
Wind Doppler Interferometer (MIGHTI)	\$40.5 M	\$29.4 M	\$69.9 M	12.04 Navigation Design	\$11.7 M		\$11.7 M
FUV/MUV Spect (IUVS-MAVEN)	\$40.9 M	\$29.6 M	\$70.5 M	Development Reserves	\$321.1 M	\$135.0 M	\$456.1 M

Cost

Cost E-F (Option 5 – 15% Reserves)

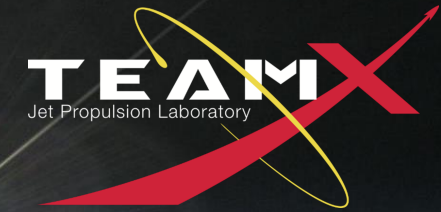

Option 5
Operations Cost
(w/ 15% Reserve)
\$282M

Operations Cost (Phases E - F)	\$282.3 M	\$0.2 M	\$282.4 M
01.0 Project Management	\$11.7 M		\$11.7 M
1.01 Project Management	\$6.8 M		\$6.8 M
1.02 Business Management	\$4.4 M		\$4.4 M
1.04 Project Reviews	\$0.4 M		\$0.4 M
02.0 Project Systems Engineering	\$0.0 M	\$0.1 M	\$0.2 M
2.06 Planetary Protection	\$0.0 M	\$0.1 M	\$0.2 M
03.0 Mission Assurance	\$4.1 M	\$0.0 M	\$4.1 M
04.0 Science	\$114.5 M		\$114.5 M
4.02 Science Team	\$114.5 M		\$114.5 M
06.0 Flight System	\$0.0 M		\$0.0 M
07.0 Mission Operations	\$95.4 M		\$95.4 M
7.0 MOS Teams	\$62.7 M		\$62.7 M
7.03 Tracking	\$23.0 M		\$23.0 M
7.06 Navigation Operations Team	\$9.2 M		\$9.2 M
7.07.03 Mission Planning Team	\$0.5 M		\$0.5 M
09.0 Ground Data Systems	\$22.7 M		\$22.7 M
9.0A GDS Teams	\$10.5 M		\$10.5 M
9.0B Science Data System Ops	\$12.0 M		\$12.0 M
9A.03.07 Navigation HW and SW Dev	\$0.2 M		\$0.2 M
11.0 Education and Public Outreach	\$0.0 M	\$0.0 M	\$0.0 M
12.0 Mission and Navigation Design	\$0.0 M		\$0.0 M
Operations Reserves	\$33.8 M	\$0.0 M	\$33.8 M

Cost

Cost A-D (Option 6 – 50% Reserves)

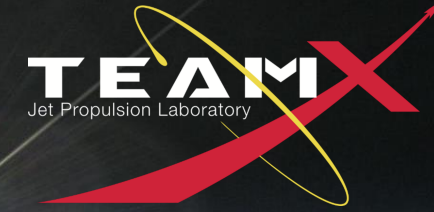

Option 6
Development Cost
(w/ 50% Reserve)
\$2.26B

Development Cost (Phases A - D)	\$1605.3 M	\$656.6 M	\$2262.0 M
01.0 Project Management	\$41.5 M		\$41.5 M
1.01 Project Management	\$17.1 M		\$17.1 M
1.02 Business Management	\$20.5 M		\$20.5 M
1.04 Project Reviews	\$3.5 M		\$3.5 M
1.06 Launch Approval	\$0.4 M		\$0.4 M
02.0 Project Systems Engineering	\$51.3 M	\$3.2 M	\$54.5 M
2.01 Project Systems Engineering	\$13.5 M		\$13.5 M
2.02 Project SW Systems Engineering	\$7.6 M		\$7.6 M
2.03 EEIS	\$0.9 M		\$0.9 M
2.04 Information System Management	\$7.9 M		\$7.9 M
2.05 Configuration Management	\$6.3 M		\$6.3 M
2.06 Planetary Protection	\$1.5 M	\$2.3 M	\$3.8 M
Mothership	\$1.5 M	\$2.3 M	\$3.8 M
2.07 Contamination Control	\$4.1 M	\$0.9 M	\$5.0 M
2.09 Launch System Engineering	\$2.4 M		\$2.4 M
2.10 Project V&V	\$6.4 M		\$6.4 M
2.11 Risk Management	\$0.7 M		\$0.7 M
03.0 Mission Assurance	\$46.4 M	\$19.0 M	\$65.4 M
04.0 Science	\$68.4 M		\$68.4 M
04.01, 04.02, & 04.03 Science Teams	\$68.4 M		\$68.4 M
05.0 Payload System	\$293.0 M	\$196.0 M	\$489.1 M
5.01 Payload Management	\$12.7 M		\$12.7 M
5.02 Payload Engineering	\$9.6 M		\$9.6 M
Element 01	\$270.7 M	\$196.0 M	\$466.7 M
P-Band SAR/Sounder Radar (SMAP)	\$85.4 M	\$61.9 M	\$147.3 M
Visible Imager (MARCI)	\$3.4 M	\$2.5 M	\$5.9 M
Limb Radiometer (Mars Climate Sounder)	\$20.0 M	\$14.5 M	\$34.5 M
Wind LIDAR (MARLI)	\$45.0 M	\$32.6 M	\$77.5 M
Sub-mm Sounder (Mars Compass)	\$33.8 M	\$24.5 M	\$58.3 M
Near IR Spect (Thoth Argus)	\$1.6 M	\$1.2 M	\$2.8 M
Wind Doppler Interferometer (MIGHTI)	\$40.5 M	\$29.4 M	\$69.9 M
FUV/MUV Spect (IUVS-MAVEN)	\$40.9 M	\$29.6 M	\$70.5 M

06.0 Flight System	\$427.8 M	\$214.8 M	\$642.5 M
6.01 Flight System Management	\$7.8 M		\$7.8 M
6.02 Flight System Systems Engineering	\$58.5 M		\$58.5 M
6.03 Product Assurance (included in 3.0)			\$0.0 M
Mothership	\$352.1 M	\$211.6 M	\$563.7 M
6.04 Power	\$22.4 M	\$44.8 M	\$67.3 M
6.05 C&DH	\$46.7 M	\$38.2 M	\$84.9 M
6.06 Telecom	\$42.0 M	\$31.3 M	\$73.4 M
6.07 Structures (includes Mech. I&T)	\$71.0 M	\$17.2 M	\$88.2 M
6.08 Thermal	\$5.1 M	\$6.2 M	\$11.3 M
6.09 Propulsion	\$67.1 M	\$39.2 M	\$106.3 M
6.10 ACS	\$25.3 M	\$18.3 M	\$43.6 M
6.11 Harness	\$15.3 M	\$12.8 M	\$28.1 M
6.12 S/C Software	\$47.9 M	\$2.5 M	\$50.5 M
6.13 Materials and Processes	\$9.3 M	\$1.0 M	\$10.4 M
6.14 Spacecraft Testbeds	\$9.3 M	\$3.1 M	\$12.5 M
07.0 Mission Operations Preparation	\$36.4 M		\$36.4 M
7.0 MOS Teams	\$33.1 M		\$33.1 M
7.03 Tracking (Launch Ops.)	\$0.7 M		\$0.7 M
7.06 Navigation Operations Team	\$2.6 M		\$2.6 M
7.07.03 Mission Planning Team	\$0.0 M		\$0.0 M
09.0 Ground Data Systems	\$40.6 M		\$40.6 M
9.0A Ground Data System	\$34.3 M		\$34.3 M
9.0B Science Data System Development	\$5.2 M		\$5.2 M
9A.03.07 Navigation H/W & S/W Development	\$1.0 M		\$1.0 M
10.0 ATLO	\$35.7 M	\$4.8 M	\$40.5 M
11.0 Education and Public Outreach	\$0.0 M	\$0.0 M	\$0.0 M
12.0 Mission and Navigation Design	\$29.3 M		\$29.3 M
12.01 Mission Design	\$3.2 M		\$3.2 M
12.02 Mission Analysis	\$6.8 M		\$6.8 M
12.03 Mission Engineering	\$7.5 M		\$7.5 M
12.04 Navigation Design	\$11.7 M		\$11.7 M
Development Reserves	\$534.9 M	\$218.9 M	\$753.7 M

Cost

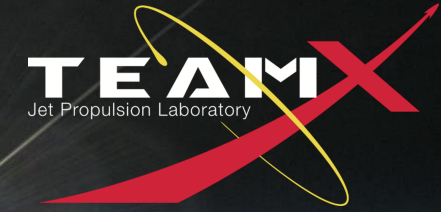

Cost E-F (Option 6 – 25% Reserves)

Option 6
Operations Cost
(w/ 25% Reserve)
\$309M

Operations Cost (Phases E - F)	\$308.5 M	\$0.2 M	\$308.7 M
01.0 Project Management	\$11.7 M		\$11.7 M
1.01 Project Management	\$6.8 M		\$6.8 M
1.02 Business Management	\$4.4 M		\$4.4 M
1.04 Project Reviews	\$0.4 M		\$0.4 M
1.06 Launch Approval	\$0.0 M		\$0.0 M
02.0 Project Systems Engineering	\$0.0 M	\$0.1 M	\$0.2 M
2.06 Planetary Protection	\$0.0 M	\$0.1 M	\$0.2 M
03.0 Mission Assurance	\$4.1 M	\$0.0 M	\$4.1 M
04.0 Science	\$114.5 M		\$114.5 M
4.02 Science Team	\$114.5 M		\$114.5 M
06.0 Flight System	\$0.0 M		\$0.0 M
07.0 Mission Operations	\$95.4 M		\$95.4 M
7.0 MOS Teams	\$62.7 M		\$62.7 M
7.03 Tracking	\$23.0 M		\$23.0 M
7.06 Navigation Operations Team	\$9.2 M		\$9.2 M
7.07.03 Mission Planning Team	\$0.5 M		\$0.5 M
09.0 Ground Data Systems	\$25.7 M		\$25.7 M
9.0A GDS Teams	\$10.5 M		\$10.5 M
9.0B Science Data System Ops	\$14.9 M		\$14.9 M
9A.03.07 Navigation HW and SW Dev	\$0.2 M		\$0.2 M
11.0 Education and Public Outreach	\$0.0 M	\$0.0 M	\$0.0 M
12.0 Mission and Navigation Design	\$0.0 M		\$0.0 M
Operations Reserves	\$57.1 M	\$0.0 M	\$57.1 M

Cost

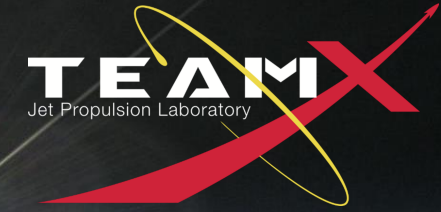

Cost A-D (Option 6 – 30% Reserves)

Option 6
Development Cost
(w/ 30% Reserve)
\$1.96B

Development Cost (Phases A - D)	\$1391.4 M	\$569.1 M	\$1960.5 M
01.0 Project Management	\$41.5 M		\$41.5 M
1.01 Project Management	\$17.1 M		\$17.1 M
1.02 Business Management	\$20.5 M		\$20.5 M
1.04 Project Reviews	\$3.5 M		\$3.5 M
1.06 Launch Approval	\$0.4 M		\$0.4 M
02.0 Project Systems Engineering	\$51.3 M	\$3.2 M	\$54.5 M
2.01 Project Systems Engineering	\$13.5 M		\$13.5 M
2.02 Project SW Systems Engineering	\$7.6 M		\$7.6 M
2.03 EEIS	\$0.9 M		\$0.9 M
2.04 Information System Management	\$7.9 M		\$7.9 M
2.05 Configuration Management	\$6.3 M		\$6.3 M
2.06 Planetary Protection	\$1.5 M	\$2.3 M	\$3.8 M
Mothership	\$1.5 M	\$2.3 M	\$3.8 M
2.07 Contamination Control	\$4.1 M	\$0.9 M	\$5.0 M
2.09 Launch System Engineering	\$2.4 M		\$2.4 M
2.10 Project V&V	\$6.4 M		\$6.4 M
2.11 Risk Management	\$0.7 M		\$0.7 M
03.0 Mission Assurance	\$46.4 M	\$19.0 M	\$65.4 M
04.0 Science	\$68.4 M		\$68.4 M
04.01, 04.02, & 04.03 Science Teams	\$68.4 M		\$68.4 M
05.0 Payload System	\$293.0 M	\$196.0 M	\$489.1 M
5.01 Payload Management	\$12.7 M		\$12.7 M
5.02 Payload Engineering	\$9.6 M		\$9.6 M
Element 01	\$270.7 M	\$196.0 M	\$466.7 M
P-Band SAR/Sounder Radar (SMAP)	\$85.4 M	\$61.9 M	\$147.3 M
Visible Imager (MARCI)	\$3.4 M	\$2.5 M	\$5.9 M
Limb Radiometer (Mars Climate Sounder)	\$20.0 M	\$14.5 M	\$34.5 M
Wind LIDAR (MARLI)	\$45.0 M	\$32.6 M	\$77.5 M
Sub-mm Sounder (Mars Compass)	\$33.8 M	\$24.5 M	\$58.3 M
Near IR Spect (Thoth Argus)	\$1.6 M	\$1.2 M	\$2.8 M
Wind Doppler Interferometer (MIGHTI)	\$40.5 M	\$29.4 M	\$69.9 M
FUV/MUV Spect (IUVS-MAVEN)	\$40.9 M	\$29.6 M	\$70.5 M

06.0 Flight System	\$427.8 M	\$214.8 M	\$642.5 M
6.01 Flight System Management	\$7.8 M		\$7.8 M
6.02 Flight System Systems Engineering	\$58.5 M		\$58.5 M
6.03 Product Assurance (included in 3.0)			\$0.0 M
Mothership	\$352.1 M	\$211.6 M	\$563.7 M
6.04 Power	\$22.4 M	\$44.8 M	\$67.3 M
6.05 C&DH	\$46.7 M	\$38.2 M	\$84.9 M
6.06 Telecom	\$42.0 M	\$31.3 M	\$73.4 M
6.07 Structures (includes Mech. I&T)	\$71.0 M	\$17.2 M	\$88.2 M
6.08 Thermal	\$5.1 M	\$6.2 M	\$11.3 M
6.09 Propulsion	\$67.1 M	\$39.2 M	\$106.3 M
6.10 ACS	\$25.3 M	\$18.3 M	\$43.6 M
6.11 Harness	\$15.3 M	\$12.8 M	\$28.1 M
6.12 S/C Software	\$47.9 M	\$2.5 M	\$50.5 M
6.13 Materials and Processes	\$9.3 M	\$1.0 M	\$10.4 M
6.14 Spacecraft Testbeds	\$9.3 M	\$3.1 M	\$12.5 M
07.0 Mission Operations Preparation	\$36.4 M		\$36.4 M
7.0 MOS Teams	\$33.1 M		\$33.1 M
7.03 Tracking (Launch Ops.)	\$0.7 M		\$0.7 M
7.06 Navigation Operations Team	\$2.6 M		\$2.6 M
7.07.03 Mission Planning Team	\$0.0 M		\$0.0 M
09.0 Ground Data Systems	\$40.6 M		\$40.6 M
9.0A Ground Data System	\$34.3 M		\$34.3 M
9.0B Science Data System Development	\$5.2 M		\$5.2 M
9A.03.07 Navigation H/W & S/W Development	\$1.0 M		\$1.0 M
10.0 ATLO	\$35.7 M	\$4.8 M	\$40.5 M
11.0 Education and Public Outreach	\$0.0 M	\$0.0 M	\$0.0 M
12.0 Mission and Navigation Design	\$29.3 M		\$29.3 M
12.01 Mission Design	\$3.2 M		\$3.2 M
12.02 Mission Analysis	\$6.8 M		\$6.8 M
12.03 Mission Engineering	\$7.5 M		\$7.5 M
12.04 Navigation Design	\$11.7 M		\$11.7 M
Development Reserves	\$320.9 M	\$131.3 M	\$452.2 M

Cost

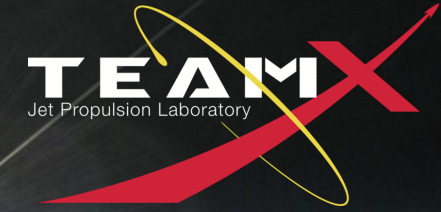

Cost E-F (Option 6 – 15% Reserves)

Option 6
Operations Cost
(w/ 15% Reserve)
\$286M

Operations Cost (Phases E - F)	\$285.7 M	\$0.2 M	\$285.8 M
01.0 Project Management	\$11.7 M		\$11.7 M
1.01 Project Management	\$6.8 M		\$6.8 M
1.02 Business Management	\$4.4 M		\$4.4 M
1.04 Project Reviews	\$0.4 M		\$0.4 M
1.06 Launch Approval	\$0.0 M		\$0.0 M
02.0 Project Systems Engineering	\$0.0 M	\$0.1 M	\$0.2 M
2.06 Planetary Protection	\$0.0 M	\$0.1 M	\$0.2 M
03.0 Mission Assurance	\$4.1 M	\$0.0 M	\$4.1 M
04.0 Science	\$114.5 M		\$114.5 M
4.02 Science Team	\$114.5 M		\$114.5 M
06.0 Flight System	\$0.0 M		\$0.0 M
07.0 Mission Operations	\$95.4 M		\$95.4 M
7.0 MOS Teams	\$62.7 M		\$62.7 M
7.03 Tracking	\$23.0 M		\$23.0 M
7.06 Navigation Operations Team	\$9.2 M		\$9.2 M
7.07.03 Mission Planning Team	\$0.5 M		\$0.5 M
09.0 Ground Data Systems	\$25.7 M		\$25.7 M
9.0A GDS Teams	\$10.5 M		\$10.5 M
9.0B Science Data System Ops	\$14.9 M		\$14.9 M
9A.03.07 Navigation HW and SW Dev	\$0.2 M		\$0.2 M
11.0 Education and Public Outreach	\$0.0 M	\$0.0 M	\$0.0 M
12.0 Mission and Navigation Design	\$0.0 M		\$0.0 M
Operations Reserves	\$34.3 M	\$0.0 M	\$34.3 M

Cost

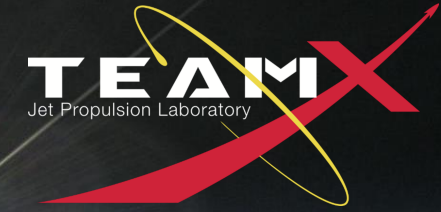

Cost A-D (Option 7 – 50% Reserves)

Option 7
Development Cost
(w/ 50% Reserve)
\$1.17B

Development Cost (Phases A - D)	\$818.2 M	\$350.1 M	\$1168.3 M
01.0 Project Management	\$21.0 M		\$21.0 M
1.01 Project Management	\$8.9 M		\$8.9 M
1.02 Business Management	\$10.2 M		\$10.2 M
1.04 Project Reviews	\$1.4 M		\$1.4 M
1.06 Launch Approval	\$0.4 M		\$0.4 M
02.0 Project Systems Engineering	\$25.9 M	\$2.9 M	\$28.7 M
2.01 Project Systems Engineering	\$8.9 M		\$8.9 M
2.02 Project SW Systems Engineering	\$5.2 M		\$5.2 M
2.03 EEIS	\$0.6 M		\$0.6 M
2.04 Information System Management	\$1.7 M		\$1.7 M
2.05 Configuration Management	\$1.6 M		\$1.6 M
2.06 Planetary Protection	\$1.5 M	\$2.3 M	\$3.8 M
Mothership	\$1.5 M	\$2.3 M	\$3.8 M
2.07 Contamination Control	\$2.6 M	\$0.6 M	\$3.2 M
2.09 Launch System Engineering	\$1.1 M		\$1.1 M
2.10 Project V&V	\$2.2 M		\$2.2 M
2.11 Risk Management	\$0.5 M		\$0.5 M
03.0 Mission Assurance	\$22.5 M	\$9.6 M	\$32.2 M
04.0 Science	\$21.0 M		\$21.0 M
04.01, 04.02, & 04.03 Science Teams	\$21.0 M		\$21.0 M
05.0 Payload System	\$73.4 M	\$47.8 M	\$121.1 M
5.01 Payload Management	\$4.3 M		\$4.3 M
5.02 Payload Engineering	\$3.1 M		\$3.1 M
Element 01	\$65.9 M	\$47.8 M	\$113.7 M
Visible Imager (MARCI)	\$3.4 M	\$2.5 M	\$5.9 M
Limb Radiometer (Mars Climate Sounder)	\$20.0 M	\$14.5 M	\$34.5 M
Near IR Spect (Thoth Argus)	\$1.6 M	\$1.2 M	\$2.8 M
FUV/MUV Spect (IUVS-MAVEN)	\$40.9 M	\$29.6 M	\$70.5 M

06.0 Flight System	\$288.5 M	\$168.5 M	\$457.0 M
6.01 Flight System Management	\$5.2 M		\$5.2 M
6.02 Flight System Systems Engineering	\$35.8 M		\$35.8 M
6.03 Product Assurance (included in 3.0)			\$0.0 M
Element 01	\$240.2 M	\$166.1 M	\$406.2 M
6.04 Power	\$15.8 M	\$38.2 M	\$53.9 M
6.05 C&DH	\$20.2 M	\$35.1 M	\$55.3 M
6.06 Telecom	\$36.4 M	\$24.1 M	\$60.5 M
6.07 Structures (includes Mech. I&T)	\$41.0 M	\$12.4 M	\$53.5 M
6.08 Thermal	\$3.6 M	\$4.2 M	\$7.8 M
6.09 Propulsion	\$59.1 M	\$29.8 M	\$88.8 M
6.10 ACS	\$18.1 M	\$15.3 M	\$33.4 M
6.11 Harness	\$4.6 M	\$4.5 M	\$9.1 M
6.12 S/C Software	\$37.7 M	\$2.0 M	\$39.7 M
6.13 Materials and Processes	\$3.8 M	\$0.4 M	\$4.2 M
6.14 Spacecraft Testbeds	\$7.4 M	\$2.5 M	\$9.8 M
07.0 Mission Operations Preparation	\$28.1 M		\$28.1 M
7.0 MOS Teams	\$25.2 M		\$25.2 M
7.03 Tracking (Launch Ops.)	\$0.7 M		\$0.7 M
7.06 Navigation Operations Team	\$2.2 M		\$2.2 M
09.0 Ground Data Systems	\$23.6 M		\$23.6 M
9.0A Ground Data System	\$20.5 M		\$20.5 M
9.0B Science Data System Development	\$2.1 M		\$2.1 M
9A.03.07 Navigation H/W & S/W Development	\$1.0 M		\$1.0 M
10.0 ATLO	\$24.3 M	\$4.6 M	\$28.9 M
11.0 Education and Public Outreach	\$0.0 M	\$0.0 M	\$0.0 M
12.0 Mission and Navigation Design	\$17.4 M		\$17.4 M
12.01 Mission Design	\$2.2 M		\$2.2 M
12.02 Mission Analysis	\$5.0 M		\$5.0 M
12.03 Mission Engineering	\$1.8 M		\$1.8 M
12.04 Navigation Design	\$8.4 M		\$8.4 M
Development Reserves	\$272.5 M	\$116.7 M	\$389.2 M

Cost

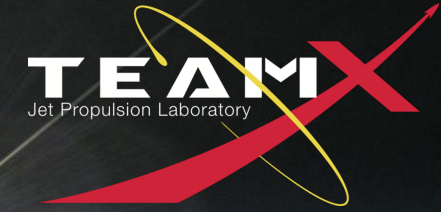

Cost E-F (Option 7 – 25% Reserves)

Option 7
Operations Cost
(w/ 25% Reserve)
\$212M

Operations Cost (Phases E - F)	\$212.0 M	\$0.2 M	\$212.2 M
01.0 Project Management	\$7.3 M		\$7.3 M
1.01 Project Management	\$4.3 M		\$4.3 M
1.02 Business Management	\$2.9 M		\$2.9 M
1.04 Project Reviews	\$0.2 M		\$0.2 M
1.06 Launch Approval	\$0.0 M		\$0.0 M
02.0 Project Systems Engineering	\$0.0 M	\$0.1 M	\$0.2 M
2.06 Planetary Protection	\$0.0 M	\$0.1 M	\$0.2 M
03.0 Mission Assurance	\$4.1 M	\$0.0 M	\$4.1 M
04.0 Science	\$52.7 M		\$52.7 M
4.02 Science Team	\$52.7 M		\$52.7 M
06.0 Flight System	\$0.0 M		\$0.0 M
07.0 Mission Operations	\$94.7 M		\$94.7 M
7.0 MOS Teams	\$62.0 M		\$62.0 M
7.03 Tracking	\$23.0 M		\$23.0 M
7.06 Navigation Operations Team	\$9.2 M		\$9.2 M
7.07.03 Mission Planning Team	\$0.5 M		\$0.5 M
09.0 Ground Data Systems	\$15.4 M		\$15.4 M
9.0A GDS Teams	\$9.2 M		\$9.2 M
9.0B Science Data System Ops	\$6.0 M		\$6.0 M
9A.03.07 Navigation HW and SW Dev	\$0.2 M		\$0.2 M
11.0 Education and Public Outreach	\$0.0 M	\$0.0 M	\$0.0 M
12.0 Mission and Navigation Design	\$0.0 M		\$0.0 M
Operations Reserves	\$37.8 M	\$0.0 M	\$37.8 M

Cost

Cost A-D (Option 7 – 30% Reserves)

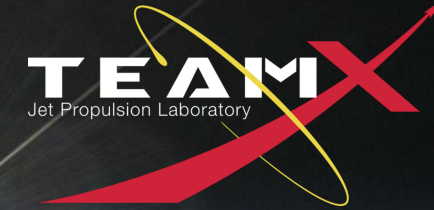

Option 7
Development Cost
(w/ 30% Reserve)
\$1B

Development Cost (Phases A - D)	\$709.3 M	\$303.4 M	\$1012.7 M
01.0 Project Management	\$21.0 M		\$21.0 M
1.01 Project Management	\$8.9 M		\$8.9 M
1.02 Business Management	\$10.2 M		\$10.2 M
1.04 Project Reviews	\$1.4 M		\$1.4 M
1.06 Launch Approval	\$0.4 M		\$0.4 M
02.0 Project Systems Engineering	\$25.9 M	\$2.9 M	\$28.7 M
2.01 Project Systems Engineering	\$8.9 M		\$8.9 M
2.02 Project SW Systems Engineering	\$5.2 M		\$5.2 M
2.03 EEIS	\$0.6 M		\$0.6 M
2.04 Information System Management	\$1.7 M		\$1.7 M
2.05 Configuration Management	\$1.6 M		\$1.6 M
2.06 Planetary Protection	\$1.5 M	\$2.3 M	\$3.8 M
Mothership	\$1.5 M	\$2.3 M	\$3.8 M
2.07 Contamination Control	\$2.6 M	\$0.6 M	\$3.2 M
2.09 Launch System Engineering	\$1.1 M		\$1.1 M
2.10 Project V&V	\$2.2 M		\$2.2 M
2.11 Risk Management	\$0.5 M		\$0.5 M
03.0 Mission Assurance	\$22.5 M	\$9.6 M	\$32.2 M
04.0 Science	\$21.0 M		\$21.0 M
04.01, 04.02, & 04.03 Science Teams	\$21.0 M		\$21.0 M
05.0 Payload System	\$73.4 M	\$47.8 M	\$121.1 M
5.01 Payload Management	\$4.3 M		\$4.3 M
5.02 Payload Engineering	\$3.1 M		\$3.1 M
Element 01	\$65.9 M	\$47.8 M	\$113.7 M
Visible Imager (MARCI)	\$3.4 M	\$2.5 M	\$5.9 M
Limb Radiometer (Mars Climate Sounder)	\$20.0 M	\$14.5 M	\$34.5 M
Near IR Spect (Thoth Argus)	\$1.6 M	\$1.2 M	\$2.8 M
FUV/MUV Spect (IUVS-MAVEN)	\$40.9 M	\$29.6 M	\$70.5 M

06.0 Flight System	\$288.5 M	\$168.5 M	\$457.0 M
6.01 Flight System Management	\$5.2 M		\$5.2 M
6.02 Flight System Systems Engineering	\$35.8 M		\$35.8 M
6.03 Product Assurance (included in 3.0)			\$0.0 M
Element 01	\$240.2 M	\$166.1 M	\$406.2 M
6.04 Power	\$15.8 M	\$38.2 M	\$53.9 M
6.05 C&DH	\$20.2 M	\$35.1 M	\$55.3 M
6.06 Telecom	\$36.4 M	\$24.1 M	\$60.5 M
6.07 Structures (includes Mech. I&T)	\$41.0 M	\$12.4 M	\$53.5 M
6.08 Thermal	\$3.6 M	\$4.2 M	\$7.8 M
6.09 Propulsion	\$59.1 M	\$29.8 M	\$88.8 M
6.10 ACS	\$18.1 M	\$15.3 M	\$33.4 M
6.11 Harness	\$4.6 M	\$4.5 M	\$9.1 M
6.12 S/C Software	\$37.7 M	\$2.0 M	\$39.7 M
6.13 Materials and Processes	\$3.8 M	\$0.4 M	\$4.2 M
6.14 Spacecraft Testbeds	\$7.4 M	\$2.5 M	\$9.8 M
07.0 Mission Operations Preparation	\$28.1 M		\$28.1 M
7.0 MOS Teams	\$25.2 M		\$25.2 M
7.03 Tracking (Launch Ops.)	\$0.7 M		\$0.7 M
7.06 Navigation Operations Team	\$2.2 M		\$2.2 M
09.0 Ground Data Systems	\$23.6 M		\$23.6 M
9.0A Ground Data System	\$20.5 M		\$20.5 M
9.0B Science Data System Development	\$2.1 M		\$2.1 M
9A.03.07 Navigation H/W & S/W Development	\$1.0 M		\$1.0 M
10.0 ATLO	\$24.3 M	\$4.6 M	\$28.9 M
11.0 Education and Public Outreach	\$0.0 M	\$0.0 M	\$0.0 M
12.0 Mission and Navigation Design	\$17.4 M		\$17.4 M
12.01 Mission Design	\$2.2 M		\$2.2 M
12.02 Mission Analysis	\$5.0 M		\$5.0 M
12.03 Mission Engineering	\$1.8 M		\$1.8 M
12.04 Navigation Design	\$8.4 M		\$8.4 M
Development Reserves	\$163.5 M	\$70.0 M	\$233.5 M

Cost

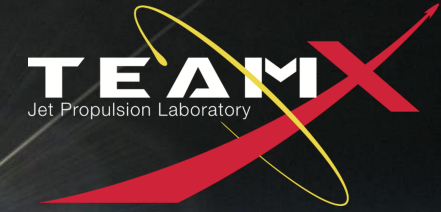

Cost E-F (Option 7 – 15% Reserves)

Option 7
Operations Cost
(w/ 15% Reserve)
\$197M

Operations Cost (Phases E - F)	\$196.9 M	\$0.2 M	\$197.1 M
01.0 Project Management	\$7.3 M		\$7.3 M
1.01 Project Management	\$4.3 M		\$4.3 M
1.02 Business Management	\$2.9 M		\$2.9 M
1.04 Project Reviews	\$0.2 M		\$0.2 M
1.06 Launch Approval	\$0.0 M		\$0.0 M
02.0 Project Systems Engineering	\$0.0 M	\$0.1 M	\$0.2 M
2.06 Planetary Protection	\$0.0 M	\$0.1 M	\$0.2 M
03.0 Mission Assurance	\$4.1 M	\$0.0 M	\$4.1 M
04.0 Science	\$52.7 M		\$52.7 M
4.02 Science Team	\$52.7 M		\$52.7 M
06.0 Flight System	\$0.0 M		\$0.0 M
07.0 Mission Operations	\$94.7 M		\$94.7 M
7.0 MOS Teams	\$62.0 M		\$62.0 M
7.03 Tracking	\$23.0 M		\$23.0 M
7.06 Navigation Operations Team	\$9.2 M		\$9.2 M
7.07.03 Mission Planning Team	\$0.5 M		\$0.5 M
09.0 Ground Data Systems	\$15.4 M		\$15.4 M
9.0A GDS Teams	\$9.2 M		\$9.2 M
9.0B Science Data System Ops	\$6.0 M		\$6.0 M
9A.03.07 Navigation HW and SW Dev	\$0.2 M		\$0.2 M
11.0 Education and Public Outreach	\$0.0 M	\$0.0 M	\$0.0 M
12.0 Mission and Navigation Design	\$0.0 M		\$0.0 M
Operations Reserves	\$22.7 M	\$0.0 M	\$22.7 M

Cost Drivers

- The number of instruments and the multi-element components.
 - This then drives the mission into a flagship category resulting in a longer schedule and more labor hours.

Potential Cost Savings

- Procuring wherever possible reduces costs. For this mission, procuring the spacecraft for the SmallSat constellations could be a significant cost savings.
- Procuring Operations services from the spacecraft vendors could also save on costs.
- Contributions

Potential Cost Uppers

- Unknown whether NASA will allow SmallSat elements to be a Class D risk posture when part of a large Flagship mission. If they must be a lower risk class, there will be cost growth.
 - This is especially true for the Areostaionary Mothership element, as it is a high cost and thus may be beyond a Class D risk classification

Cost Risks and Mitigation Plans

- Although we've done Mars orbiters before, we've never done a mission with motherships and a constellation of SmallSats and daughter ships in Mars's orbit. These are uncharted waters and we don't have a good analogous mission to compare to and draw lessons learned from.

Cost

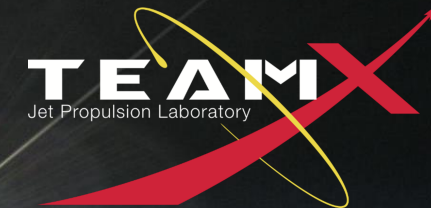

Option Comparison (50% Reserve)

- **Option 1 - \$2.60B – Mothership w/ 8 instruments – Flagship Class**
- **Option 2 – \$3.94B - Same Mothership technical design as Option 1, but the cost accounting includes a full project-level roll-up of all of the elements in the constellation**
- **Option 3 – \$1.40B - Mothership w/ 4 instruments – New Frontiers Class**
- **Option 4 – \$2.79B - Same Mothership technical design as Option 3, but the cost accounting includes a full project-level roll-up of all of the elements in the constellation**
- **Option 5 – \$2.59B – Modified Option 1 with a resized propulsion system**
- **Option 6 - \$2.57B – Modified Option 5 with no carried elements**
- **Option 7 – \$1.38B – Modified Option 3 with no carried elements**

	Options	1	2	3	4	5	6	7
Project Cost		\$2601.4 M	\$3939.1 M	\$1401.4 M	\$2792.3 M	\$2586.5 M	\$2570.7 M	\$1380.5 M
Launch Vehicle		\$0.0 M	\$0.0 M	\$0.0 M	\$0.0 M	\$0.0 M	\$0.0 M	\$0.0 M
Project Cost (w/o LV)		\$2601.4 M	\$3939.1 M	\$1401.4 M	\$2792.3 M	\$2586.5 M	\$2570.7 M	\$1380.5 M
Development Cost		\$2296.4 M	\$3472.9 M	\$1189.2 M	\$2388.1 M	\$2281.5 M	\$2262.0 M	\$1168.3 M
Operations Cost		\$305.0 M	\$466.2 M	\$212.2 M	\$404.2 M	\$305.0 M	\$308.7 M	\$212.2 M
WBS Elements		1st Unit	1st Unit	1st Unit	1st Unit	1st Unit	1st Unit	1st Unit
Project Cost (including Launch Vehicle)		\$2601.4 M	\$3939.1 M	\$1401.4 M	\$2792.3 M	\$2586.5 M	\$2570.7 M	\$1380.5 M
Development Cost (Phases A - D)		\$2296.4 M	\$3472.9 M	\$1189.2 M	\$2388.1 M	\$2281.5 M	\$2262.0 M	\$1168.3 M
01.0 Project Management		\$41.5 M	\$41.5 M	\$21.0 M	\$30.4 M	\$41.5 M	\$41.5 M	\$21.0 M
02.0 Project Systems Engineering		\$54.5 M	\$98.8 M	\$28.7 M	\$74.0 M	\$54.5 M	\$54.5 M	\$28.7 M
03.0 Mission Assurance		\$66.3 M	\$99.1 M	\$32.7 M	\$65.0 M	\$65.9 M	\$65.4 M	\$32.2 M
04.0 Science		\$68.4 M	\$80.7 M	\$21.0 M	\$33.3 M	\$68.4 M	\$68.4 M	\$21.0 M
05.0 Payload System		\$489.1 M	\$686.8 M	\$121.1 M	\$294.1 M	\$489.1 M	\$489.1 M	\$121.1 M
06.0 Flight System		\$665.6 M	\$981.4 M	\$470.4 M	\$789.8 M	\$656.1 M	\$642.5 M	\$457.0 M
07.0 Mission Operations Preparation		\$36.4 M	\$77.1 M	\$28.1 M	\$72.4 M	\$36.4 M	\$36.4 M	\$28.1 M
09.0 Ground Data Systems		\$39.5 M	\$81.8 M	\$23.6 M	\$75.0 M	\$39.5 M	\$40.6 M	\$23.6 M
10.0 ATLO		\$40.5 M	\$75.4 M	\$28.9 M	\$72.2 M	\$40.5 M	\$40.5 M	\$28.9 M
11.0 Education and Public Outreach		\$0.0 M	\$0.0 M	\$0.0 M	\$0.0 M	\$0.0 M	\$0.0 M	\$0.0 M
12.0 Mission and Navigation Design		\$29.3 M	\$92.9 M	\$17.4 M	\$86.0 M	\$29.3 M	\$29.3 M	\$17.4 M
Development Reserves		\$765.2 M	\$1157.4 M	\$396.1 M	\$795.8 M	\$760.2 M	\$753.7 M	\$389.2 M
Operations Cost (Phases E - F)		\$305.0 M	\$466.2 M	\$212.2 M	\$404.2 M	\$305.0 M	\$308.7 M	\$212.2 M
01.0 Project Management		\$11.7 M	\$11.7 M	\$7.3 M	\$11.7 M	\$11.7 M	\$11.7 M	\$7.3 M
02.0 Project Systems Engineering		\$0.2 M	\$0.2 M	\$0.2 M	\$0.2 M	\$0.2 M	\$0.2 M	\$0.2 M
03.0 Mission Assurance		\$4.1 M	\$0.0 M	\$4.1 M	\$0.0 M	\$4.1 M	\$4.1 M	\$4.1 M
04.0 Science		\$114.5 M	\$119.7 M	\$52.7 M	\$58.0 M	\$114.5 M	\$114.5 M	\$52.7 M
06.0 Flight System		\$0.0 M	\$0.0 M	\$0.0 M	\$0.0 M	\$0.0 M	\$0.0 M	\$0.0 M
07.0 Mission Operations		\$95.4 M	\$193.1 M	\$94.7 M	\$208.3 M	\$95.4 M	\$95.4 M	\$94.7 M
09.0 Ground Data Systems		\$22.7 M	\$52.8 M	\$15.4 M	\$49.9 M	\$22.7 M	\$25.7 M	\$15.4 M
11.0 Education and Public Outreach		\$0.0 M	\$0.0 M	\$0.0 M	\$0.0 M	\$0.0 M	\$0.0 M	\$0.0 M
12.0 Mission and Navigation Design		\$0.0 M	\$0.0 M	\$0.0 M	\$0.0 M	\$0.0 M	\$0.0 M	\$0.0 M
Operations Reserves		\$56.4 M	\$88.6 M	\$37.8 M	\$76.2 M	\$56.4 M	\$57.1 M	\$37.8 M
8.0 Launch Vehicle		\$0.0 M	\$0.0 M	\$0.0 M	\$0.0 M	\$0.0 M	\$0.0 M	\$0.0 M
Launch Vehicle and Processing		\$0.0 M	\$0.0 M	\$0.0 M	\$0.0 M	\$0.0 M	\$0.0 M	\$0.0 M
Nuclear Payload Support		\$0.0 M	\$0.0 M	\$0.0 M	\$0.0 M	\$0.0 M	\$0.0 M	\$0.0 M

Cost

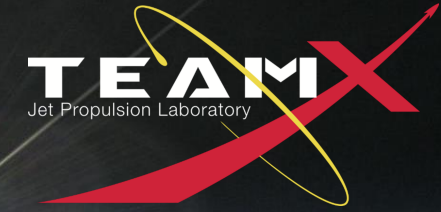

Option Comparison (30% Reserve)

- **Option 1 - \$2.23B – Mothership w/ 8 instruments – Flagship Class**
- **Option 2 – \$3.44B - Same Mothership technical design as Option 1, but the cost accounting includes a full project-level roll-up of all of the elements in the constellation**
- **Option 3 – \$1.23B - Mothership w/ 4 instruments – New Frontiers Class**
- **Option 4 – \$2.44B - Same Mothership technical design as Option 3, but the cost accounting includes a full project-level roll-up of all of the elements in the constellation**
- **Option 5 – \$2.26B - Modified Option 1 with a resized propulsion system**
- **Option 6 - \$2.25B - Modified Option 5 with no carried elements**
- **Option 7 – \$1.21B - Modified Option 3 with no carried elements**

	Options	1	2	3	4	5	6	7
Project Cost		\$2272.8 M	\$3440.7 M	\$1227.8 M	\$2443.5 M	\$2259.8 M	\$2246.3 M	\$1209.7 M
Launch Vehicle		\$0.0 M	\$0.0 M	\$0.0 M	\$0.0 M	\$0.0 M	\$0.0 M	\$0.0 M
Project Cost (w/o LV)		\$2272.8 M	\$3440.7 M	\$1227.8 M	\$2443.5 M	\$2259.8 M	\$2246.3 M	\$1209.7 M
Development Cost		\$1990.3 M	\$3010.0 M	\$1030.7 M	\$2069.8 M	\$1977.4 M	\$1960.5 M	\$1012.6 M
Operations Cost		\$282.4 M	\$430.7 M	\$197.1 M	\$373.7 M	\$282.4 M	\$285.8 M	\$197.1 M
WBS Elements		1st Unit	1st Unit	1st Unit	1st Unit	1st Unit	1st Unit	1st Unit
Project Cost (including Launch Vehicle)		\$2272.8 M	\$3440.7 M	\$1227.8 M	\$2443.5 M	\$2259.8 M	\$2246.3 M	\$1209.7 M
Development Cost (Phases A - D)		\$1990.3 M	\$3010.0 M	\$1030.7 M	\$2069.8 M	\$1977.4 M	\$1960.5 M	\$1012.6 M
01.0 Project Management		\$41.5 M	\$41.5 M	\$21.0 M	\$30.4 M	\$41.5 M	\$41.5 M	\$21.0 M
02.0 Project Systems Engineering		\$54.5 M	\$98.8 M	\$28.7 M	\$74.0 M	\$54.5 M	\$54.5 M	\$28.7 M
03.0 Mission Assurance		\$66.3 M	\$99.1 M	\$32.7 M	\$65.0 M	\$65.9 M	\$65.4 M	\$32.2 M
04.0 Science		\$68.4 M	\$80.7 M	\$21.0 M	\$33.3 M	\$68.4 M	\$68.4 M	\$21.0 M
05.0 Payload System		\$489.1 M	\$686.8 M	\$121.1 M	\$294.1 M	\$489.1 M	\$489.1 M	\$121.1 M
06.0 Flight System		\$665.6 M	\$981.4 M	\$470.4 M	\$789.8 M	\$656.1 M	\$642.5 M	\$457.0 M
07.0 Mission Operations Preparation		\$36.4 M	\$77.1 M	\$28.1 M	\$72.4 M	\$36.4 M	\$36.4 M	\$28.1 M
09.0 Ground Data Systems		\$39.5 M	\$81.8 M	\$23.6 M	\$75.0 M	\$39.5 M	\$40.6 M	\$23.6 M
10.0 ATLO		\$40.5 M	\$75.4 M	\$28.9 M	\$72.2 M	\$40.5 M	\$40.5 M	\$28.9 M
11.0 Education and Public Outreach		\$0.0 M	\$0.0 M	\$0.0 M	\$0.0 M	\$0.0 M	\$0.0 M	\$0.0 M
12.0 Mission and Navigation Design		\$29.3 M	\$92.9 M	\$17.4 M	\$86.0 M	\$29.3 M	\$29.3 M	\$17.4 M
Development Reserves		\$459.1 M	\$694.4 M	\$237.7 M	\$477.5 M	\$456.1 M	\$452.2 M	\$233.5 M
Operations Cost (Phases E - F)		\$282.4 M	\$430.7 M	\$197.1 M	\$373.7 M	\$282.4 M	\$285.8 M	\$197.1 M
01.0 Project Management		\$11.7 M	\$11.7 M	\$7.3 M	\$11.7 M	\$11.7 M	\$11.7 M	\$7.3 M
02.0 Project Systems Engineering		\$0.2 M	\$0.2 M	\$0.2 M	\$0.2 M	\$0.2 M	\$0.2 M	\$0.2 M
03.0 Mission Assurance		\$4.1 M	\$0.0 M	\$4.1 M	\$0.0 M	\$4.1 M	\$4.1 M	\$4.1 M
04.0 Science		\$114.5 M	\$119.7 M	\$52.7 M	\$58.0 M	\$114.5 M	\$114.5 M	\$52.7 M
06.0 Flight System		\$0.0 M	\$0.0 M	\$0.0 M	\$0.0 M	\$0.0 M	\$0.0 M	\$0.0 M
07.0 Mission Operations		\$95.4 M	\$193.1 M	\$94.7 M	\$208.3 M	\$95.4 M	\$95.4 M	\$94.7 M
09.0 Ground Data Systems		\$22.7 M	\$52.8 M	\$15.4 M	\$49.9 M	\$22.7 M	\$25.7 M	\$15.4 M
11.0 Education and Public Outreach		\$0.0 M	\$0.0 M	\$0.0 M	\$0.0 M	\$0.0 M	\$0.0 M	\$0.0 M
12.0 Mission and Navigation Design		\$0.0 M	\$0.0 M	\$0.0 M	\$0.0 M	\$0.0 M	\$0.0 M	\$0.0 M
Operations Reserves		\$33.8 M	\$53.2 M	\$22.7 M	\$45.7 M	\$33.8 M	\$34.3 M	\$22.7 M
8.0 Launch Vehicle		\$0.0 M	\$0.0 M	\$0.0 M	\$0.0 M	\$0.0 M	\$0.0 M	\$0.0 M
Launch Vehicle and Processing		\$0.0 M	\$0.0 M	\$0.0 M	\$0.0 M	\$0.0 M	\$0.0 M	\$0.0 M
Nuclear Payload Support		\$0.0 M	\$0.0 M	\$0.0 M	\$0.0 M	\$0.0 M	\$0.0 M	\$0.0 M

Appendix C Special Technical Analyses

Contents

C.1	Mission Design.....	C-2
C.1.1	Launch Vehicles	C-2
C.1.2	Low-Thrust Trajectory Design (Mothership)	C-2
C.1.3	SEP Thrusters.....	C-6
C.1.4	Alternate Architecture	C-6
C.2	Platform Specific Mission Design	C-8
C.2.1	Polar Mission Design.....	C-8
C.2.2	Elliptical Mission Design	C-9
C.2.3	Areostationary Mission Design	C-10
C.3	Constellation Risk Assessment	C-11
C.4	Radio Occultation Simulations	C-12

Figures

Figure C-1.	Launch vehicle performance guideline options.....	C-2
Figure C-2.	Some results of Mission Analysis Low-Thrust Optimization (MALTO) trajectory optimization parametric runs. Delivered mass is optimized for given times-of-flight and power levels.....	C-3
Figure C-3.	Selected trajectory information.....	C-4
Figure C-4.	Delivered mass optimization with expendable falcon heavy.....	C-5
Figure C-5.	Optimizing effective delivered mass versus power and TOF.....	C-5
Figure C-6.	Information on AEPS thruster.....	C-6
Figure C-7.	Some possible alternative architectures to deliver the MOSAIC constellation.....	C-7

Tables

Table C-1.	Mission parameters for selected trajectories.....	C-4
Table C-2.	Thruster options and parameters.....	C-6

C.1 Mission Design

C.1.1 Launch Vehicles

In the coming decade there will be a number of medium and heavy-lift launch vehicles available, many of which are slated to have their inaugural launches in the next few years. This will potentially drive competition, increase availability, and reduce costs. Launch vehicles such as Falcon Heavy, Vulcan, Omega, and New Glenn can meet the needs of a MOSAIC launch. This is true whether a SEP or a traditional chemical propulsion system is ultimately chosen. A SEP propulsion system enables the use of the smallest and most-affordable of the launch vehicles because it typically requires a lower launch C3 (2-12 km²/s², subject to optimization). In Figure C-1, option 4 corresponds to the performance of the Falcon Heavy Recoverable. It can accommodate up to 5850 kg at a C3 of 5 km²/s² and was the target for this study.

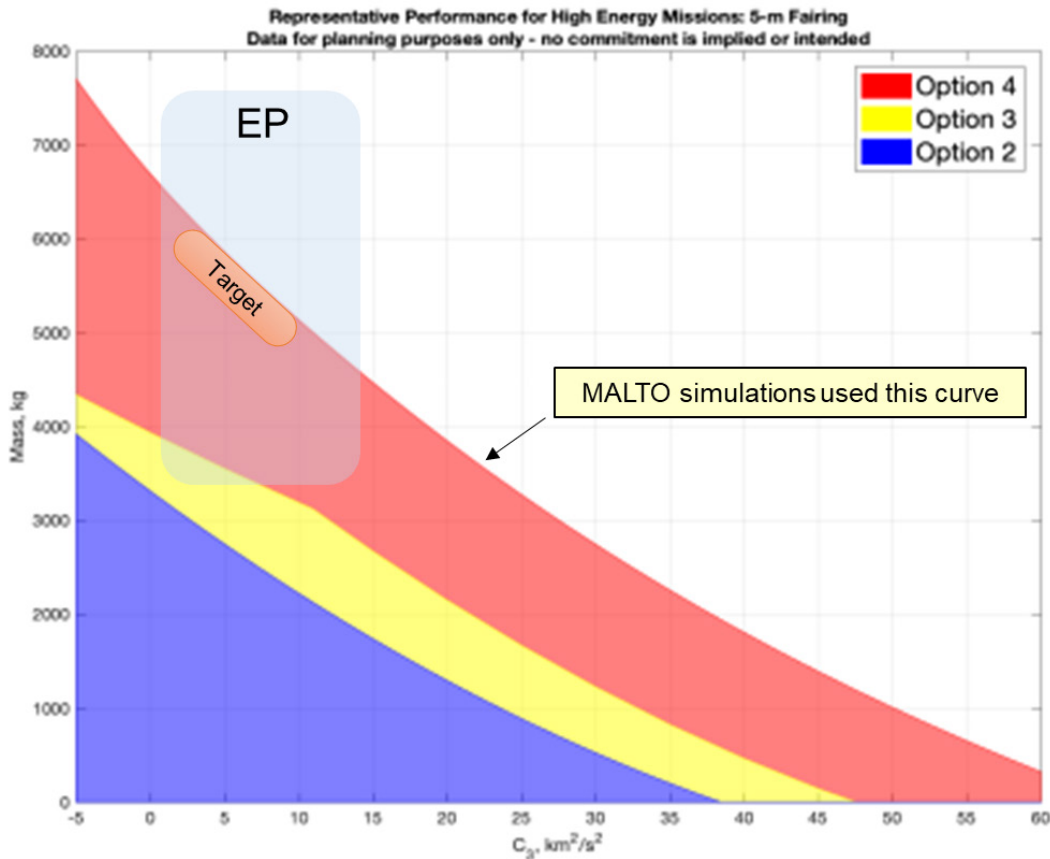

Figure C-1. Launch vehicle performance guideline options.

C.1.2 Low-Thrust Trajectory Design (Mothership)

Low-thrust trajectories from Earth to Mars differ from ballistic transfers in that there is not a unique solution for each launch/arrival date pair. Every trajectory must be optimized to determine a control law based on thruster characteristics, mass, power, and other constraints. Optimization for this study was carried out using simulations in MALTO—a robust, medium-fidelity optimizer developed at JPL. MALTO is particularly adept at parametric trade space exploration. Power, mass, and time-of-flight were varied to create large databases of optimized trajectories from which to choose. To first order, a low-thrust trajectory from Earth escape to Mars orbit typically requires:

- 3.5–4 km/s of ΔV for the heliocentric cruise
- 2.6–3 km/s of ΔV for the spiral down to low-Mars orbit
- ~1 km/s for maneuvers in orbit including a 3-degree plane change
- Total: 7–8 km/s

The exact numbers are determined through an iterative process that considers the thruster characteristics, power available, total mass, launch vehicle performance, launch dates, times-of-flight, etc. The following targets were used:

- Launch years: 2026–2035 (with 2026 used for reference)
- Typical Durations:
 - Cruise: 10–15 months
 - Spiral: 6–12 months
 - Total: ~ 2 years
- Falcon Heavy Recoverable
- Power: 12–30 kW

Optimization for this study was carried out using simulations in MALTO—a robust, medium-fidelity optimizer developed at JPL. Power level and time-of-flight (TOF) were swept parameters to create a database of thousands of trajectories from which to choose. Figure C-2 shows some of the results of the trade space. For each power level and TOF, the maximum delivered mass to Mars orbit was calculated given the use of one AEPS thruster and starting on a Falcon Heavy Recoverable. As expected, mass delivered increases with increasing flight times and power levels. There is a “knee” in the curve around 2 years TOF and above 20 kW.

MALTO Results

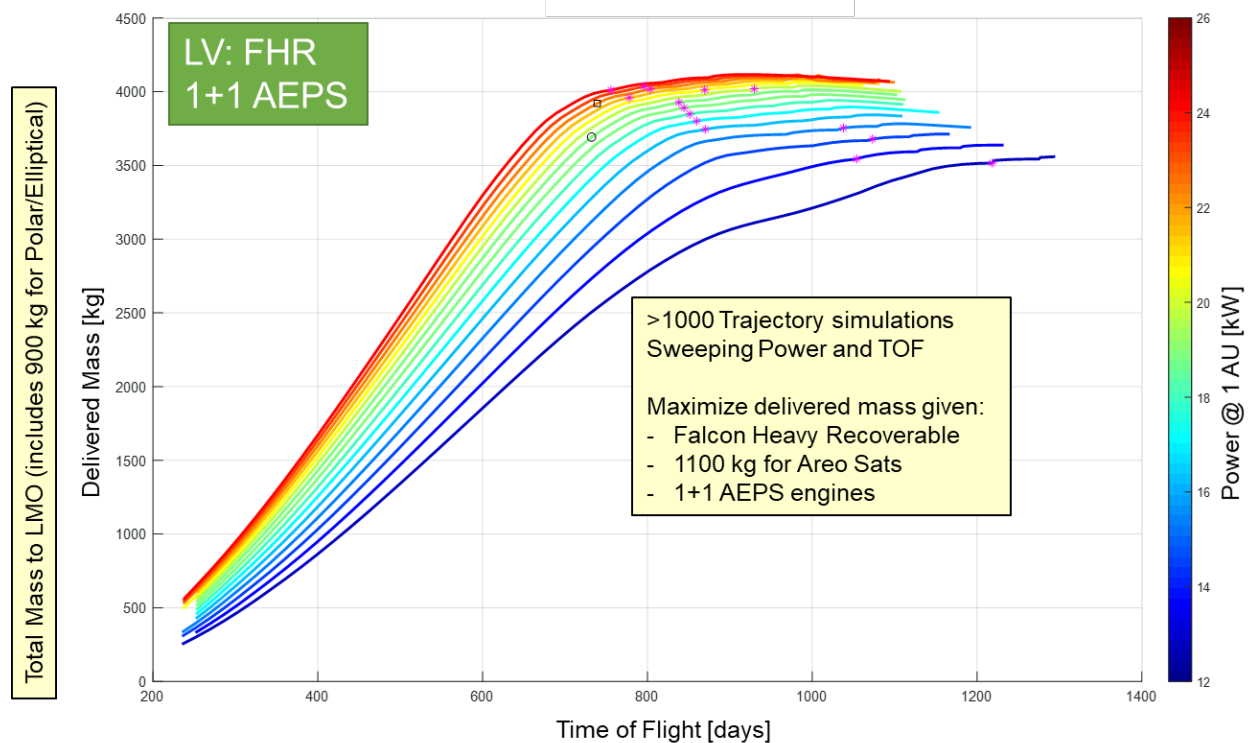

Figure C-2. Some results of Mission Analysis Low-Thrust Optimization (MALTO) trajectory optimization parametric runs. Delivered mass is optimized for given times-of-flight and power levels.

Table C-1 shows a few of the most promising trajectories and their respective parameters. Case 1 was selected as a reference for the study. It has a total launch mass (for the whole constellation) of 6275 kg and takes just over two years for the Mothership to arrive in low-Mars orbit. The launch C3 is 2.5 km²/s² and it requires 7.1 km/s of ΔV through cruise and spiral. Figure C-3 shows the trajectory plot in the upper left, and the power, solar distance, and specific impulse (Isp) histories across the bottom.

Table C-1. Mission parameters for selected trajectories.

Case	Power	TOF-E2M	TOF_Spiral	TOF_Total	Launch	SpirStart	SpirEnd	MassLaunch	MassAtSep	MassAtMars C30	MassAtLMO
1	22	1.37	0.75	2.12	09/09/2026	01/22/2028	10/21/2028	6275	5175	4397	3922
2	22	1.32	0.74	2.05	09/18/2026	01/11/2028	10/07/2028	6186	5086	4334	3864
3	22	1.26	0.72	1.98	10/02/2026	01/05/2028	09/25/2028	6047	4947	4239	3779
4	22	1.18	0.68	1.86	10/18/2026	12/22/2027	08/28/2028	5751	4651	3990	3555
5	22	1.12	0.64	1.77	10/29/2026	12/13/2027	08/04/2028	5459	4359	3743	3334
6	26	1.34	0.67	2.01	09/09/2026	01/12/2028	09/13/2028	6280	5180	4434	3988
7	20	1.45	0.78	2.24	08/24/2026	02/05/2028	11/17/2028	6344	5244	4401	3900
8	16	1.42	0.87	2.29	09/10/2026	02/12/2028	12/24/2028	6217	5117	4262	3708

Case	MassAtLMO	MassOrbiter	Eff mass	CruiseXe	SpirXe	XeMassTotal	C3	DV Cruise	DVspiral	DVtot
1	3922	3035	2689	777	476	1253	2.5	4.178	2.939	7.166
2	3864	2977	2635	752	470	1221	3.1	4.073	2.922	6.995
3	3779	2892	2555	708	460	1168	4.0	3.897	2.899	6.796
4	3555	2668	2338	661	435	1096	5.9	3.831	2.882	6.713
5	3334	2447	2125	616	409	1025	7.8	3.771	2.866	6.637
6	3988	3101	2722	745	446	1191	2.5	4.199	2.866	7.065
7	3900	3013	2679	843	501	1343	2.1	4.365	3.009	7.374
8	3709	2821	2520	855	554	1409	2.9	4.040	3.075	7.114

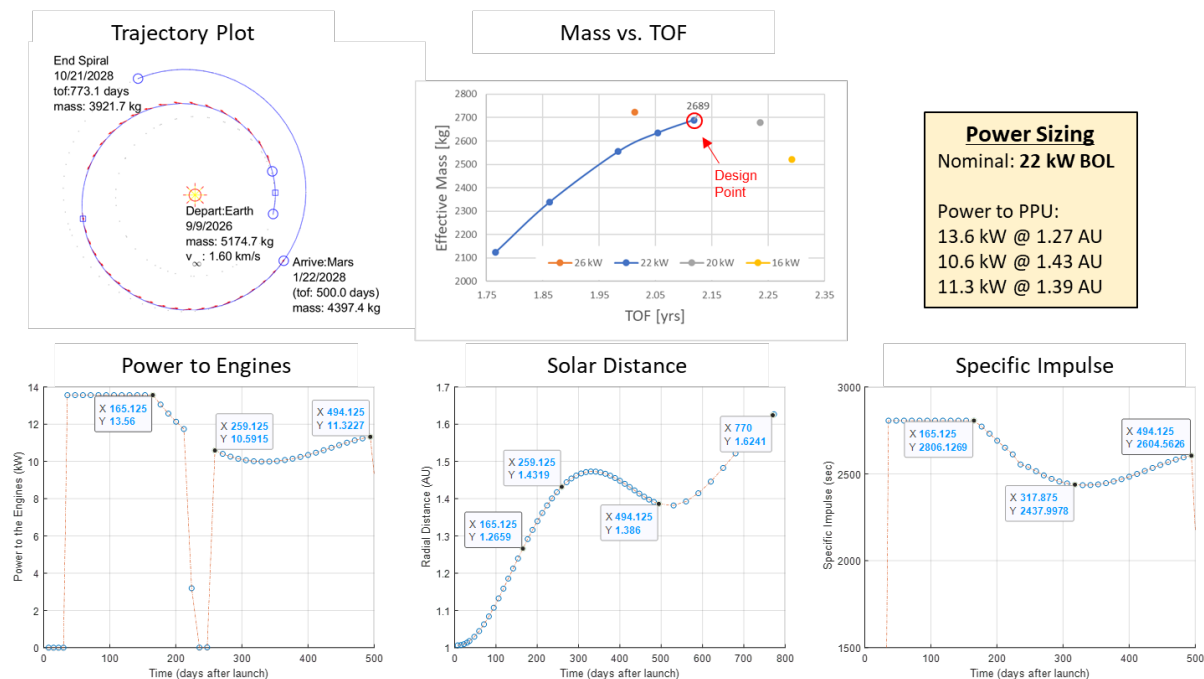

Figure C-3. Selected trajectory information.

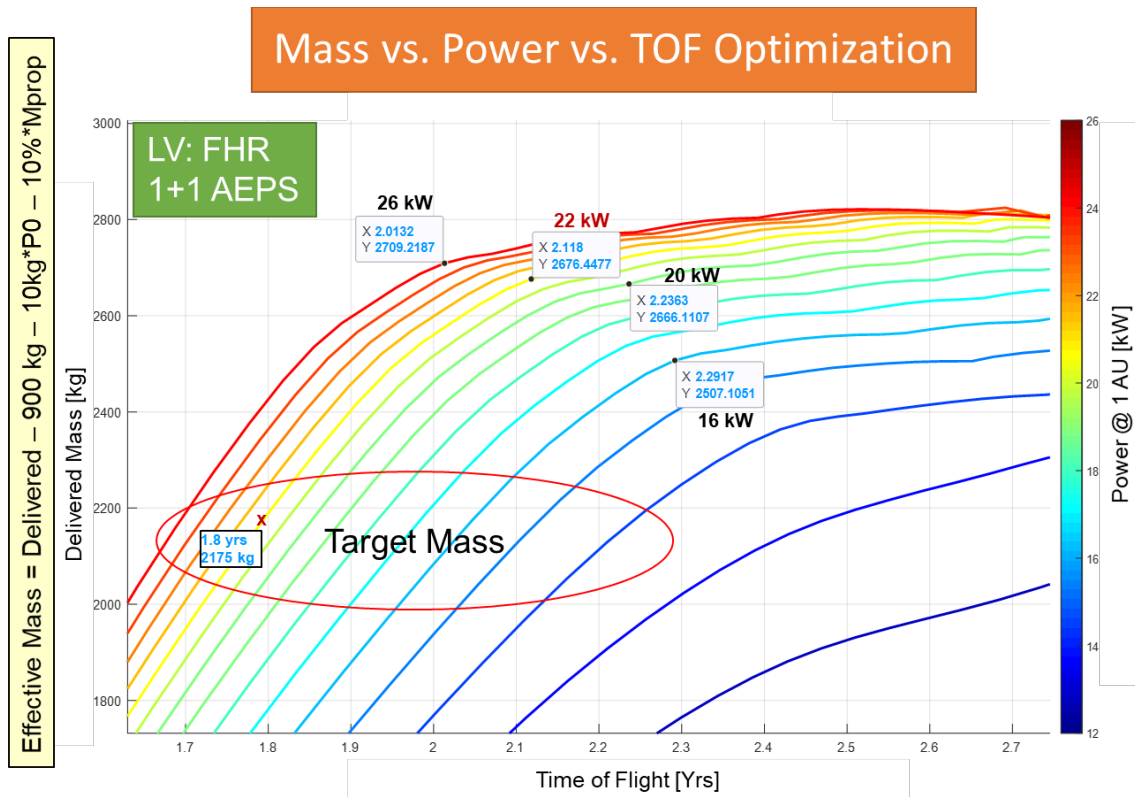

Figure C.4. Delivered mass optimization with expendable falcon heavy.

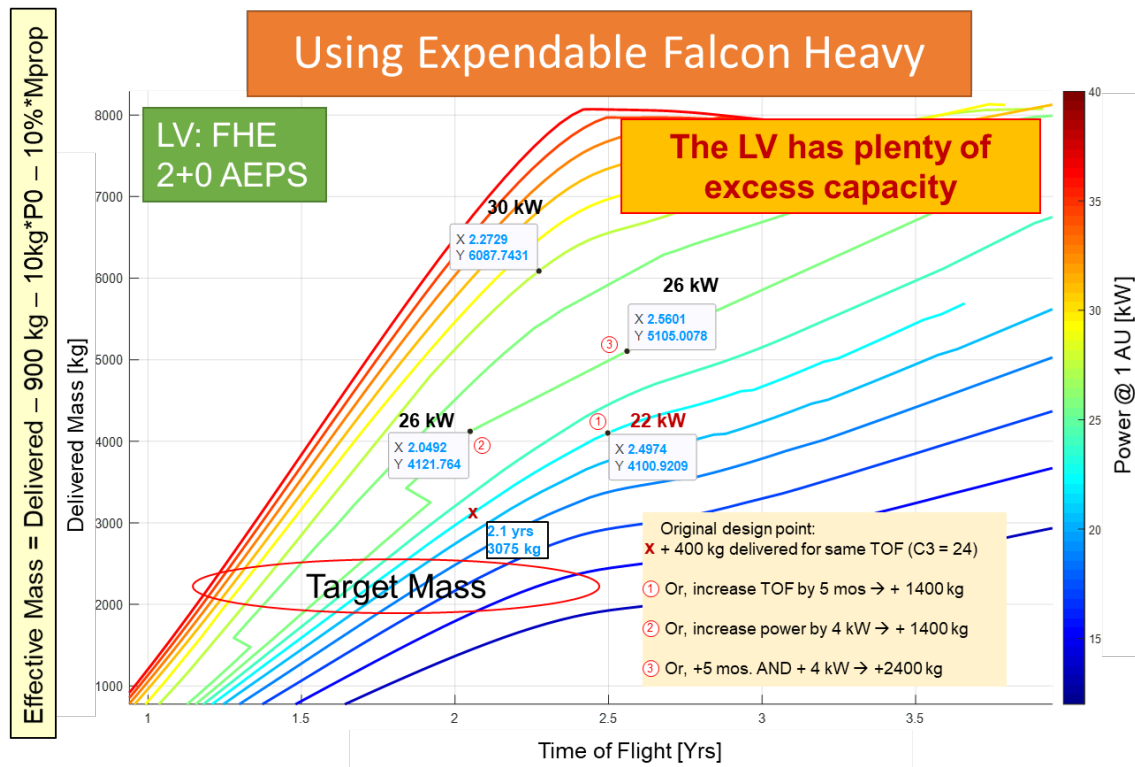

Figure C-5. Optimizing effective delivered mass versus power and TOF.

C.1.3 SEP Thrusters

There are many large SEP thrusters that could be considered for a mission to Mars. These include both Hall-effect (AEPS, SPT-140, XR-5) and ion (Radio-Frequency Ion Thruster (RIT), Xenon Ion Propulsion System (XIPS), and NASA Evolutionary Xenon Thruster (NEXT)) (see Table C-2). Suitable thrusters would be able to operate at 2-12 kW and have a lifetime more than 200 kg of xenon in total throughput. Multiple thrusters would be required for redundancy, throttling, and throughput.

Table C-2. Thruster options and parameters.

Thruster	Type	Thrust*	Specific Impulse*	Power*
-	-	[mN]	[s]	[kW]
AEPS	Hall	600	2900	13.3
SPT-140	Hall	260	1720	5.5
XR-5	Hall	280	2000	4.8
NEXT-C	Ion	220	4000	6.8
RIT 2X	Ion	250	4100	8.5
XIPS	Ion	175	3500	5

*Representative numbers, consult manufacturers for current specs.

For the MOSAIC mothership, the AEPS thruster was chosen, which has its heritage from the Asteroid Robotic Redirect Mission (ARRM). It is a large, 14 kW Hall-effect thruster with magnetic shielding leading to a very long lifetime (Figure C-6). Its high thrust, Isp, and throughput make it well suited to deliver a constellation of spacecraft with a wet mass over 5,000 kg.

ARM/PPE Based System:

- 1+1 AEPS (1 or 2 active)
- Max throughput: > 3000 kg
- Masses [kg]:
 - ◆ Thruster [x2] - 43
 - ◆ PPU [x2] - 42
 - ◆ Gimbal [x2]- 9.5
 - ◆ XFC [x2] – 2.5

Advanced Electric Propulsion System
14 kW Hall Thruster

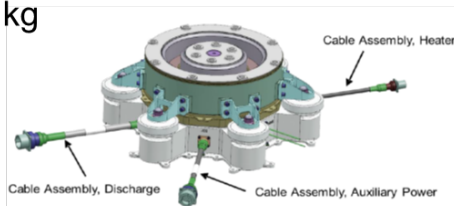

Lunar PPE (Maxar)
will use 4 x AEPS
engines and 60 kW
ROSA arrays

Figure C-6. Information on AEPS thruster.

C.1.4 Alternate Architecture

The MOSAIC constellation can naturally be broken in to three main components: the mothership, the low-Mars orbit smallsats (polar and elliptical), and the areostationary spacecraft. The baseline architecture outlined in this document meets the full baseline requirements of each investigation and delivers all spacecraft using just two SEP propulsion systems, one on the mothership and the other on the areostationary carrier. Other architectures were also outlined and considered for study.

In Figure C-7, the first alternative architecture considered was to reduce the scope of the Mothership by removing the ice and wind investigations, leading to a much smaller mothership (3700 kg → 2500 kg). The constellation delivery was otherwise the same with two SEP propulsion systems. An alternative this is to have the smallsats be delivered by a chemical-powered propulsive

element (Alternate 1a and 1b), which provides the Mars Orbit Insertion (MOI) burn with aerobraking down to the final orbits. The mothership SEP system is then only responsible for itself, which allowed it to be much smaller, especially for the descoped mini-mothership in Alternate 1b. The launch masses were similar to the baseline method, but total mission cost could be reduced if a suitable commercial propulsive ESPA could be adapted.

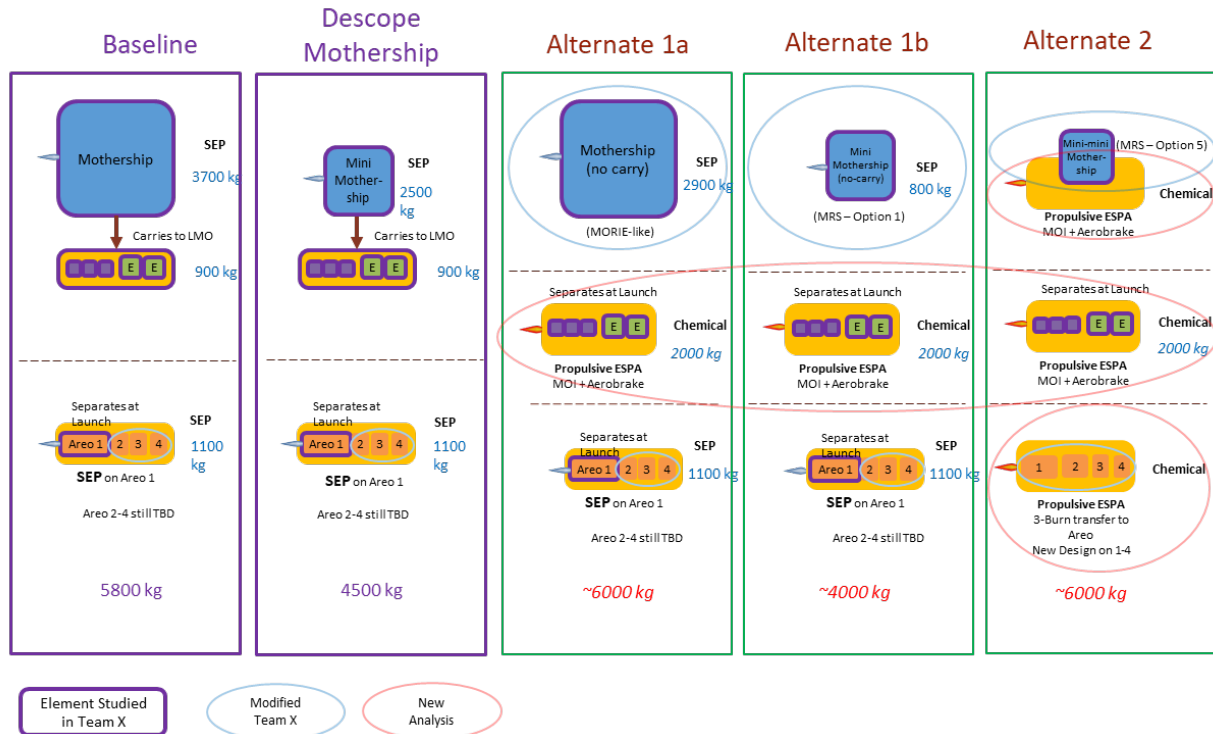
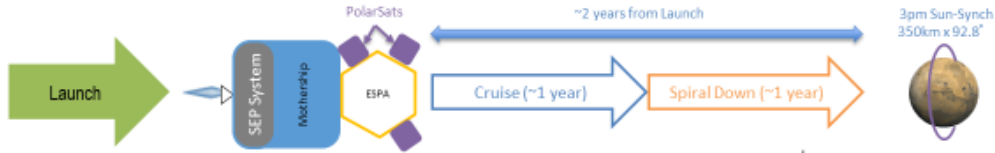

Figure C.7. Some possible alternative architectures to deliver the MOSAIC constellation.

The final architecture (Alternate 2) delivers the full constellation (with reduced mothership) using chemical propulsion. The launch mass is increased significantly vs. Alternate 1b, but this may not be an issue if a large launch vehicle is selected. Significant cost savings could be realized if a similar propulsive element could be designed to deliver all three portions of the constellation. Of course, and all chemical architecture would lose the benefits and flexibility of SEP, and carries some large technical and mission risks.

C.2 Platform Specific Mission Design

C.2.1 Polar Mission Design



- ❖ From 3pm orbit each PolarSat will:
 - Change inclination by $\pm 1.7^\circ$ (100 m/s)
 - Drift in LST for 5 or 10 months
 - Change inc. back to 92.8° (100 m/s)
- ❖ LST drift due to J2 is $\sim 1/3^\circ$ /day
 - Polar 1 – Inc. $+1.7^\circ$, drift 5 mos. to 12pm
 - Polar 2 – Inc. -1.7° , drift 5 mos. to 6pm
 - Polar 3 – Inc. -1.7° , drift 10 mos. to 9pm
- ❖ Science possible during drift
- ❖ 25 m/s for orbit maintenance

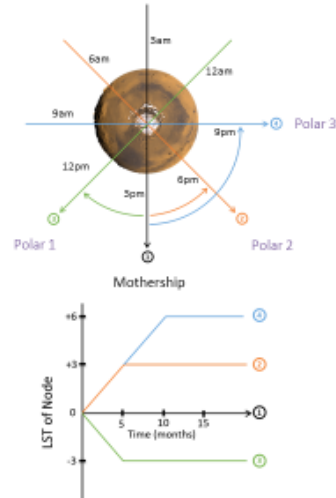

C.2.2 Elliptical Mission Design

TEAM Polar Node Drift Analysis JPL

Inclination Change for $\Delta\Omega$ (For Polar LST change)



- Spending ΔV to change inclination in order to get a node rate is universally more efficient than using altitude change
 - Even with altitude raise “free”
 - Even vs. combined alt/inc maneuvers
- Allows ΔLST in both directions
- Continuous measurements while drifting LST’s
- Process from 320 km - change inclination by 1-2 degrees, wait a few months, change back

$$\dot{\Omega} = - \left[\frac{3 \sqrt{\mu} J_2 R^2}{2(1-e^2)^2 a^3} \right] \cos i$$

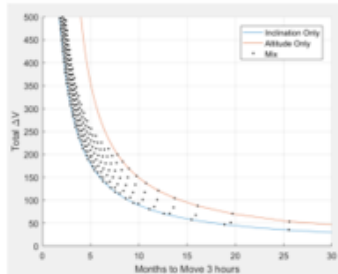

Δ inc deg	DV m/s	Mprop kg	Prop% mos.	Sun Synchronous		
				Δ RAAN deg/day	Δ LST day/deg	Δ S hrs
0.2	24	0.2	1%	0.04	25.2	37.8
0.4	47	0.4	2%	0.08	12.6	18.9
0.6	71	0.6	4%	0.12	8.4	12.6
0.8	94.6	0.7	5%	0.16	6.3	9.4
1	118	0.9	6%	0.20	5.0	7.6
1.2	142	1.1	7%	0.24	4.2	6.3
1.4	166	1.3	8%	0.28	3.6	5.4
1.6	189	1.5	9%	0.32	3.2	4.7
1.8	213	1.7	10%	0.36	2.8	4.2
2	236	1.9	11%	0.40	2.5	3.8
2.2	260.1	2.1	12%	0.44	2.3	3.4

TEAM Elliptical Constellation Delivery JPL

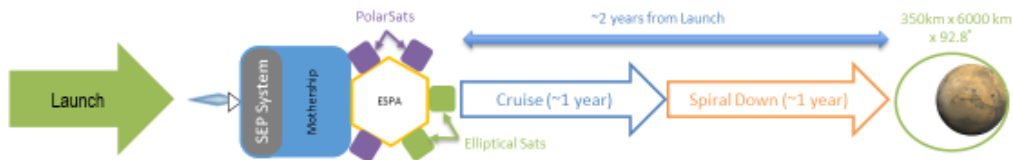

- ❖ Mothership spirals to 350 x 6000 km x 92.8°
- ❖ Ellipticals Separate from ESPA
- ❖ Maneuver Sequence
 - Plane Change 92.8° → 75°
 - Drop periapsis to 150 km
 - Separate true anomaly by 30° “Pearls on a String”
- ❖ Sequence ΔV : 500 m/s
- ❖ Orbit ΔV : 50 m/s
- ❖ **Total ΔV : 550 m/s (600 m/s allocated)**

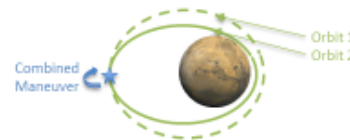

	Orbit 1	Orbit 2	
Periapsis	350	150	km
Apoapsis	6000	6000	km
i	92.8	75	deg
rp	3746.19	3546.19	km
ra	9296.19	9296.19	km
a	8571.19	8471.19	km
e	0.4299069	0.452003	
Vp	4.0431957	4.187633	km/s
Va	1.6119916	1.580443	km/s
P	4.4923918	4.390236	hrs
P sol	0.1821748	0.178032	sol

DV1	494.9
DV2	0.0
Total DV	494.9

C.2.3 Areostationary Mission Design

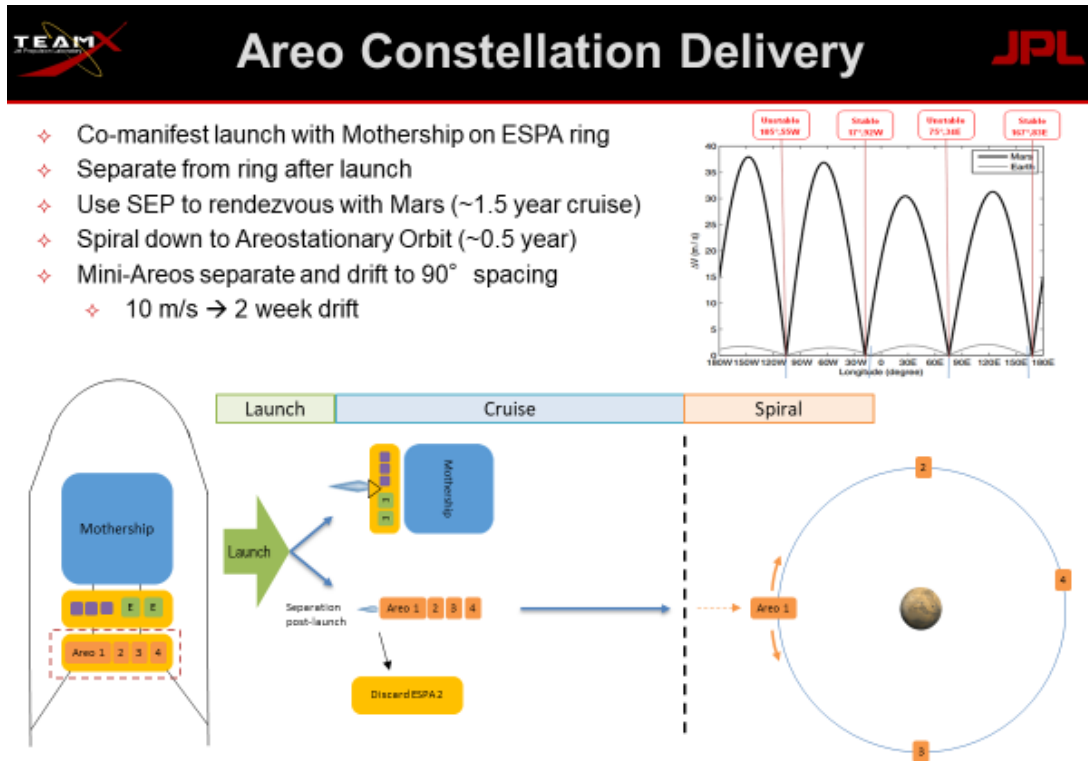

Areo Mission Design

- ◆ 2 MaSMi Thrusters
- ◆ 3.3 kW BOL arrays

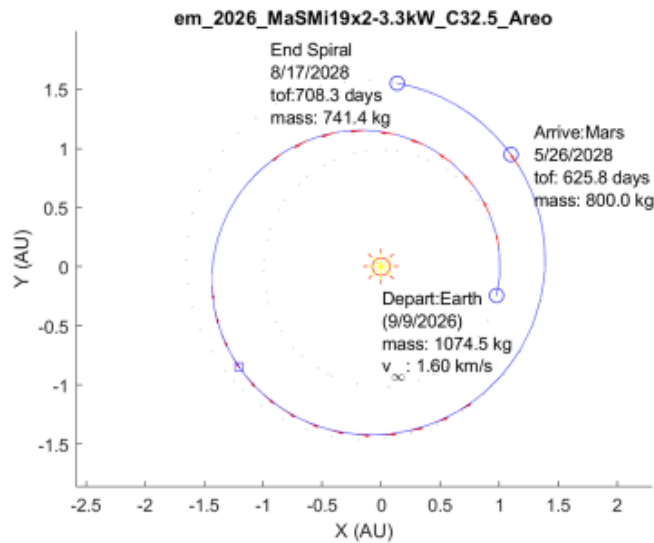

C.3 Constellation Risk Assessment

The following pages provide the MOSAIC constellation probability of success detailed analysis.

MOSAIC Constellation Probability of Success Detailed Analysis

Outline

- A) Summary
- B) Launch, Cruise, Spiral, and Deployment
- C) Constellation Elements in Science Orbits

A) Summary

- The probability of success that the entire constellation will return baseline science varies from close to 90% to almost 100% (see slide 33, “Risk Sensitivity (20/20)”)
- The probability of success needs further study for the solar electric propulsion and deployment success
- The largest increase in probability of success is dependent upon the mothership radar/sounder, and selected redundant electronics likely yields the greatest increase
- Further study of the constellation, and constellation replenishment is important for future technical and cost decisions

- This high-level constellation probability of success analysis is included so that future studies can build upon the methodology and results
- The results of the constellation probability of success analysis did not influence the selection of baseline and threshold. Those constellation architectures were established early in the study towards ensuring the greatest science data return of the emplaced, functioning spacecraft
- The results discussed in this appendix are to be considered very preliminary and included for informational purposes only

Connections between science and architectures

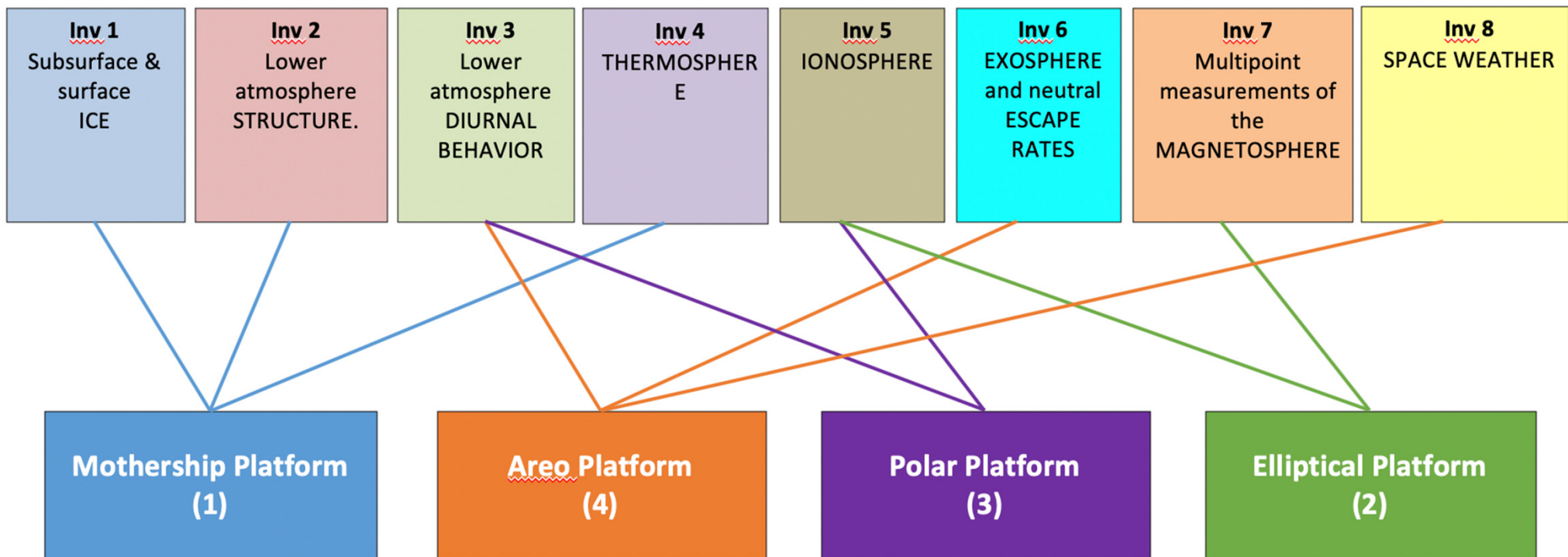

Science Success Criteria

Baseline Success Criteria					
Investigation	Mothership Platform (1)	Areo Carrier (1)	Small Areo Platform (3)	Polar Platform (3)	Elliptical Platform (2)
1 – Ice Distribution	1/1				
2 – Atmosphere Structure	1/1				
3 – Atm. Diurnal Behavior		1/1	3/3	3/3	
4 - Thermosphere	1/1				
5 - Ionosphere				3/3	2/2
6- Exosphere, Neutral Escape		1/1	3/3		
7 – Plasma and Ion Escape					2/2
8 – Space Weather		3/3	3/3		
Threshold Success Criteria					
Investigation	Mothership Platform (1)	Areo Carrier (1)	Small Areo Platform (3)	Polar Platform (3)	Elliptical Platform (2)
1 – Ice Distribution	1/1				
2 – Atmosphere Structure	1/1				
3 – Atm. Diurnal Behavior			1/4	1/3	
4 - Thermosphere	1/1				
5 - Ionosphere				1/3	1/2
6- Exosphere, Neutral Escape			1/4		
7 – Plasma and Ion Escape					1/2
8 – Space Weather			1/4		

Communication Success Criteria

- The Mothership and Areo 1 through 4 communicate directly with Earth.
- The 3 Polar platforms and 2 Elliptical platforms communicate with Earth through the Mothership.
- Loss of the Mothership will limit science return to just those Areo platforms still functional.

Mission End State Definitions

- End state, OK \Rightarrow baseline success criteria for all investigations are achieved.
- End state, Min \Rightarrow all platforms meet or exceed their threshold success criteria, but at least one platform fails to satisfy its baseline success criteria.
- End state, LOM \Rightarrow at least one platform fails to satisfy its threshold success criteria.

Constellation Delivery (Example Option)

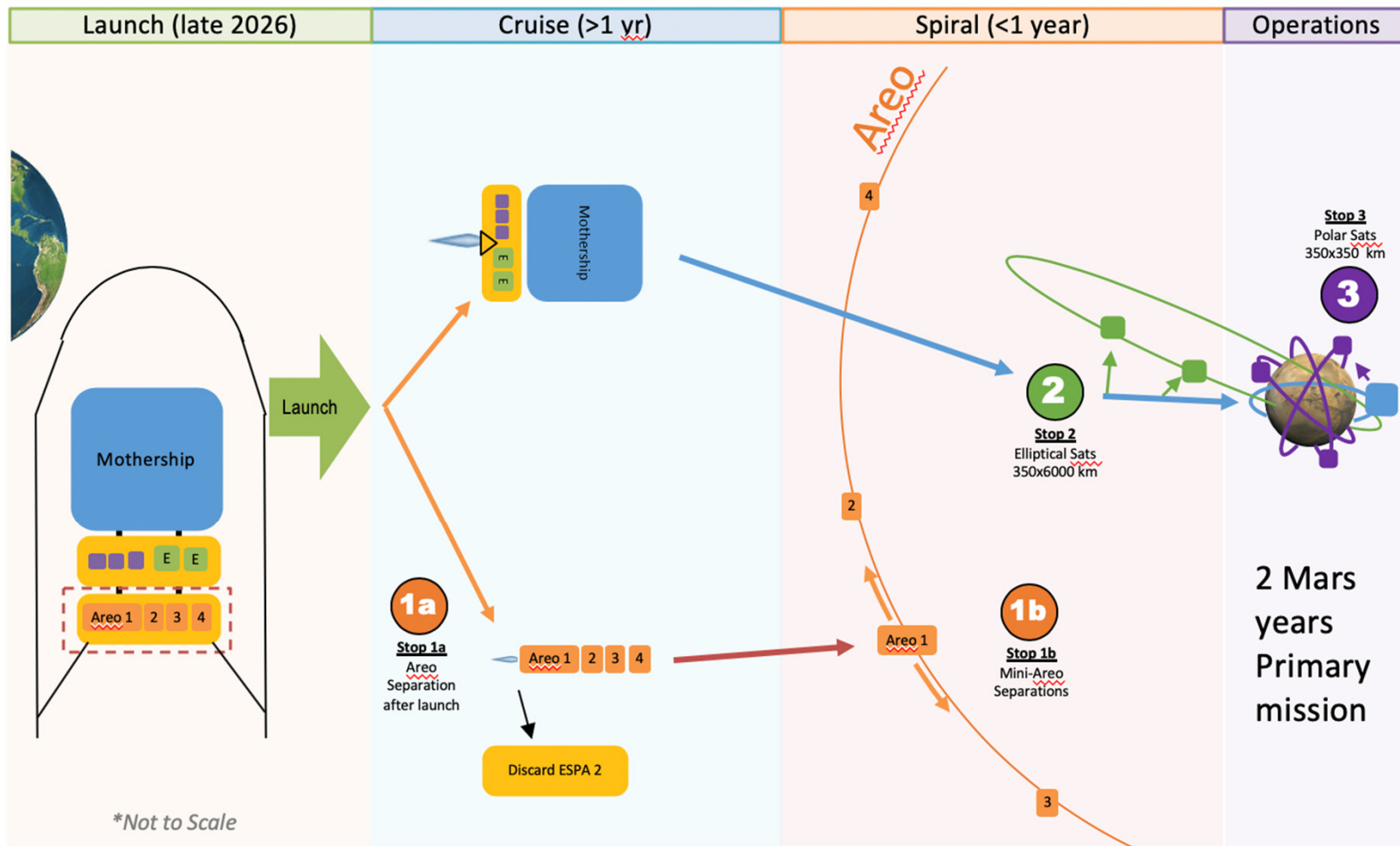

End State Models (1/2)

$$\Pr(\text{OK}) = \Pr(\text{L})\Pr(\text{C}|\text{L})\Pr(\text{S}|\text{L} \cap \text{C})\Pr(\text{OK}|\text{L} \cap \text{C} \cap \text{S})$$

- $\Pr(\text{OK}) \Rightarrow$ probability end state OK occurs
- $\Pr(\text{L}) \Rightarrow$ probability launch is successful = 1.0
- $\Pr(\text{C}|\text{L}) \Rightarrow$ conditional probability cruise is successful, given a successful launch = 1.0
- $\Pr(\text{S}|\text{L} \cap \text{C}) \Rightarrow$ conditional probability spiral is successful, given successful launch and cruise = 1.0
- $\Pr(\text{OK}|\text{L} \cap \text{C} \cap \text{S}) \Rightarrow$ conditional probability end state OK occurs, given successful launch, cruise, and spiral

End State Models (2/2)

$$\Pr(\text{Min}) = \Pr(L)\Pr(C|L)\Pr(S|L \cap C)\Pr(\text{Min}|L \cap C \cap S)$$

- $\Pr(\text{Min}) \Rightarrow$ probability end state Min occurs
 - $\Pr(\text{Min}|L \cap C \cap S) \Rightarrow$ conditional probability end state Min occurs, given successful launch, cruise, and spiral
-

$$\Pr(\text{LOM}) = 1 - \Pr(\text{OK}) - \Pr(\text{Min})$$

- $\Pr(\text{LOM}) \Rightarrow$ probability end state LOM occurs

B) Launch, Cruise, Spiral, and Deployment

- More analysis is needed on the launch, cruise, spiral to low Mars orbit, and deployment probabilities of success for Class B and smallsats
- It is assumed in this study that the probability of success of these mission phases and events is 100% (or 1.0)

Model Quantification (1/2)

- Building risk models for mission concepts is relatively easy.
- One merely combines fundamental reliability models in a manner that aligns with the mission concept. This is an exercise in applied mathematics.
- Quantifying the model is challenging because for every model input parameter (e.g., a failure rate or probability) the available literature will typically offer a plethora of sometimes disparate data, or virtually no data.
- Mathematical models are human creations which can easily be changed by humans.

Model Quantification (2/2)

- Failure rates and probabilities are metrics for how system elements have performed in reality, and deciding which will be representative of a concept if it is eventually built and flown is very hard.
- Hence, the challenge with model quantification is not with *getting numbers*, but with:
 - obtaining *representative* numbers;
 - understanding the sensitivity of predicted risk to those numbers; and
 - offering an approach for ensuring that the as-flown mission will achieve the risk predicted with the numbers.

Risk Sensitivity (1/20)

Going through the model, if a leaf element had perfect reliability it would increase Pr(OK). Therefore, an instructive sensitivity study is to assess how much Pr(OK) increases if each leaf element failure probability is set to zero.

Definitions:

Perfect Mothership Radar: Radar has probability of success of 1.0 during mission

Enhanced Mothership Radar: Radar has selected redundancy in the electronics

Perfect Cameras: Cameras have probability of success of 1.0 during mission

Perfect MRO strings: Mothership spacecraft has dual strings, much like MRO, that function perfectly

Perfect Asset Deployment: All deployments are successful

Perfect propulsion: Solar Electric Propulsion and Spacecraft on-board hydrazine propulsion work perfectly

Perfect launch: Launch works perfectly

Flawless side swaps: MRO-like dual redundant mothership spacecraft works perfectly if side swaps occur

Reference mission: Original calculation in model.

Included only for relative reference here

- Five suppositions are imposed to illustrate this quantification.
- 1) Electric propulsion is not needed during the operations phase.
 - 2) Except for the Mothership, each constellation asset has a single string MRO bus coupled to a science payload.
 - 3) Except for the Mothership, each constellation asset has a single science instrument with a reliability resembling that of a camera. This simplifying assumption can be modified to capture any science payload configuration.
 - 4) The Mothership has a redundant MRO bus operated in a cold spare configuration. The science payload is comprised of a camera and radar. Both are needed to achieve requires science.
 - 5) Payload duty cycles are close to 100% for each asset.

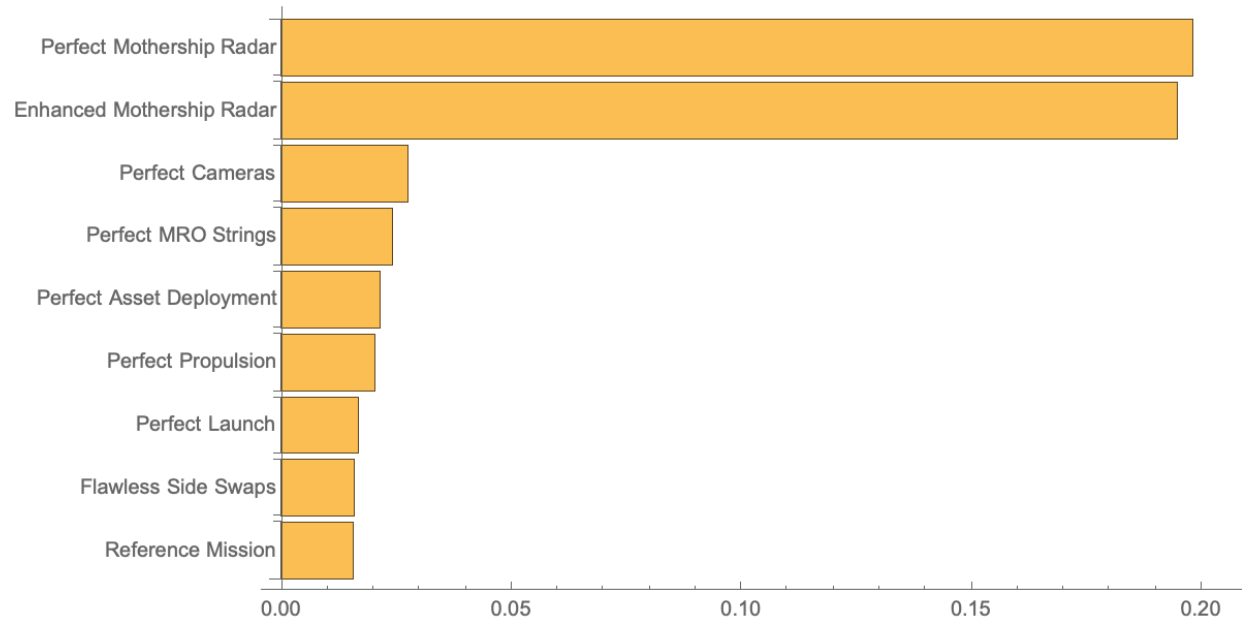

Risk Sensitivity (2/20)

- The dominant risk driver, by far, is the radar in the Mothership payload using this high level model.
- Reviewing Ref. 11 reveals that the failure rate is for naval radar used by the military. This could be a very harsh environment compared to a Mars science mission.
- References 13 and 14 report radar failure rates on the order of 10^{-6} per hour, about two orders of magnitude lower than the value of λ_R from Ref. 11.
- According to the bar chart on Slide 14, using this enhanced value for the Mothership radar increases the mission success probability almost as much as the assumption of perfect radar reliability.

Risk Sensitivity (3/20)

- However, before adopting this enhanced value radar subject matter experts should be consulted to ensure its applicability.
 - Perhaps the two order of magnitude difference is due to technology advances in the almost three decade interval between publication of Ref. 11 and Refs. 13 and 14.
 - Perhaps it primarily results from a conservative bias in Ref. 11, along with optimistic calculations in Refs. 13 and 14.
 - Ideally, one should examine flight telemetry from candidate heritage missions to furnish a more defensible estimate for λ_R .
- To further illustrate the risk assessment process, hypothesize that 10^{-6} per hour is an applicable value for λ_R .

Risk Sensitivity (4/20)

- Then the bar chart for mission success probability sensitivity becomes:

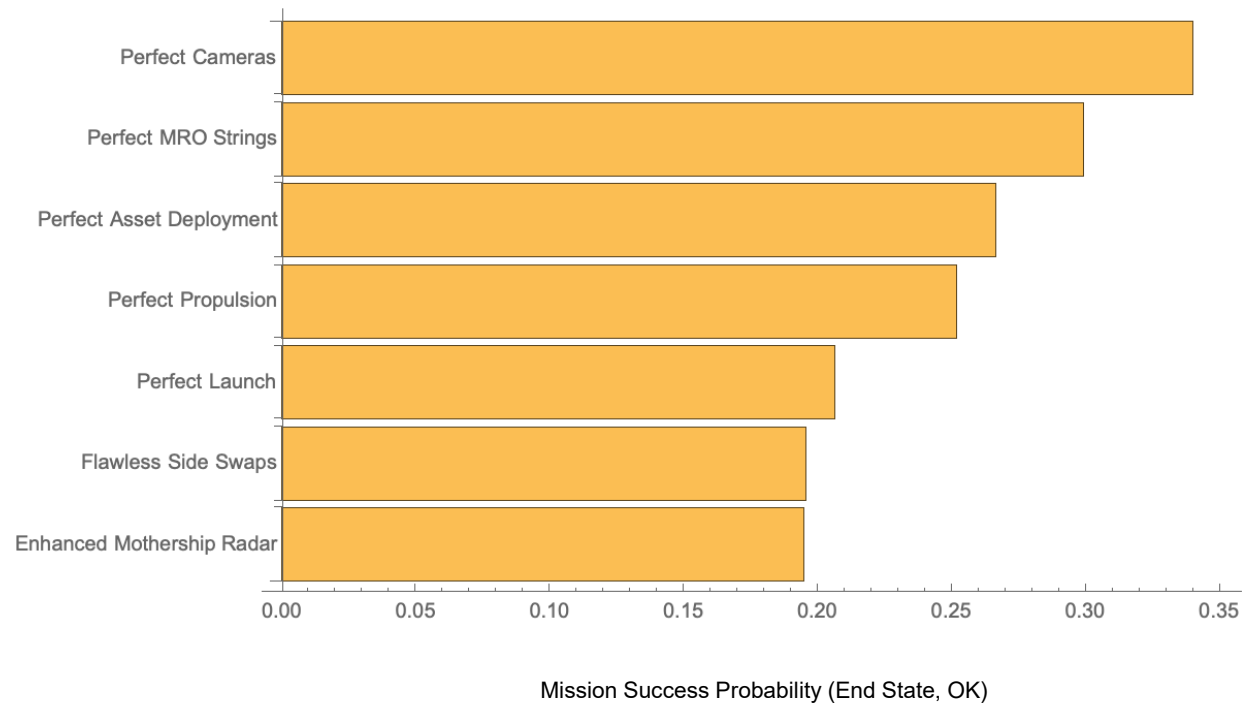

Risk Sensitivity (5/20)

- Now the payload cameras and MRO strings become the risk drivers.
- The sensitivity of $\text{Pr}(\text{OK})$ to λ_C and λ_{CS} is:

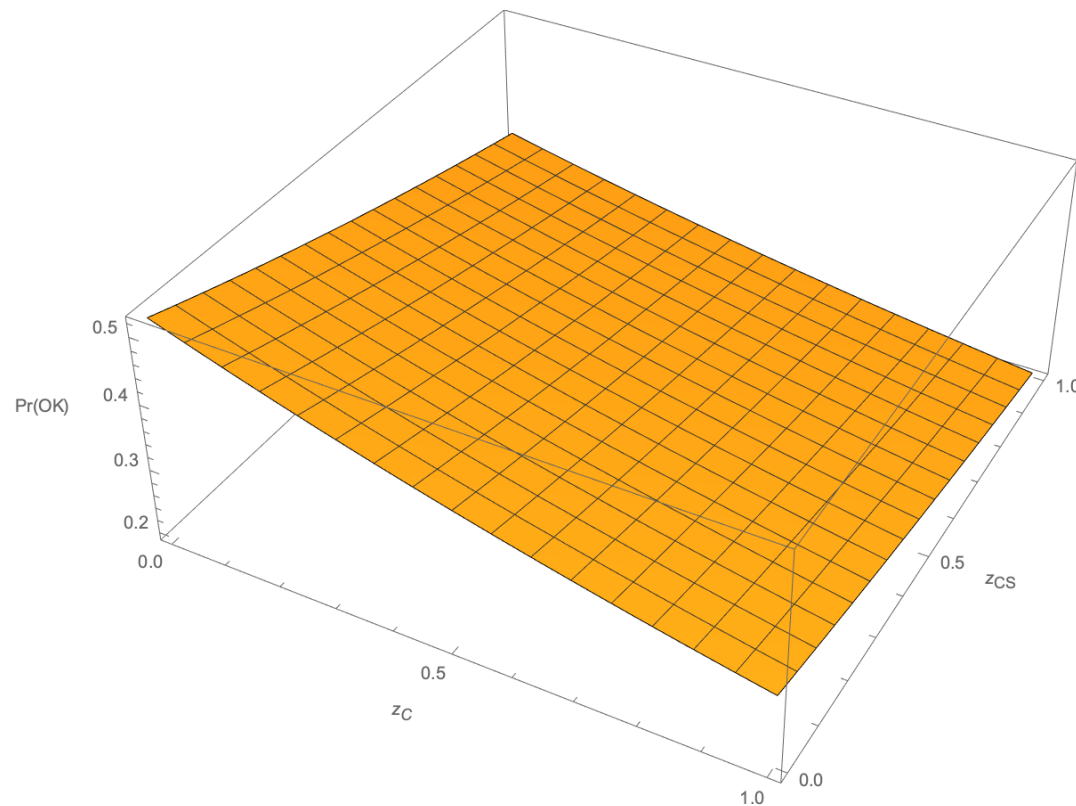

Risk Sensitivity (6/20)

- Here z_C and z_{CS} are scaling factors which multiply λ_C and λ_{CS} in the model for $\text{Pr}(\text{OK})$. When a scaling factor is zero the associated failure rate becomes zero. If a scaling factor is unity the associated failure rate has its original value.
- One could continue identifying risk drivers and adjusting their values to produce a more positive view of mission risk.
- However such an activity, without technical justification, is an exercise in numerology instead of risk assessment.
- Ultimately, all values used in a risk assessment require a defensible basis.

Risk Sensitivity (7/20)

- If that basis comes from reports such as Refs. 11, 13, and 14, then subject matter experts must supply a rationale as to why the values in those reports are applicable to the concept being proposed.
- Unless the reports include sufficient provenance for their sources of information, the applicability of their data to the concept being proposed becomes suspect.
- If input data come from heritage flight data or flight-like testing, then information needed to ascertain data applicability becomes available.

Risk Sensitivity (8/20)

- For hardware designed, fabricated, tested, and flown in accordance with JPL Design Principals and Flight Project Practices, or the principals and practices of approved vendors, convincing stakeholders that comparable reliability will be achieved on a proposed mission becomes easier.
- Because of limitations in applicable data relating to new technology, there is always a risk associated with that limited knowledge.
- When such data limitations exist, plausible ranges for the data should be established and risk sensitivity to variations in those data demonstrated.

Risk Sensitivity (9/20)

- The sensitivity of $\Pr(\text{Min})$ to the failure rates and probabilities used in the risk model is:

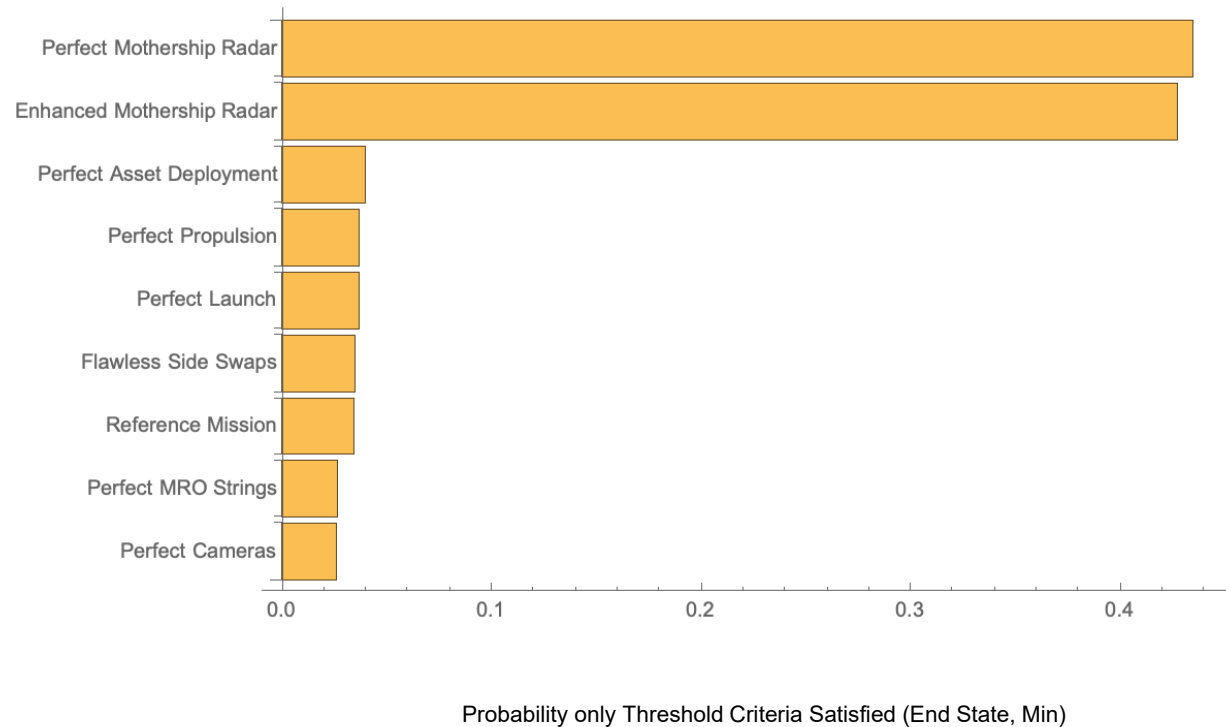

Risk Sensitivity (10/20)

- The reference mission is the mission depicted in Slide 8, subject to the success criteria in Slide 5 and 6.
- Recall that $\text{Pr}(\text{Min})$ is defined as all platforms meeting or exceed their threshold success criteria, but at least one platform failing to satisfy its baseline success criteria. Thus OK, Min, and LOM are mutually exclusive.
- Note that $\text{Pr}(\text{Min})$ for the reference mission decreases if the MRO strings or payload cameras have perfect reliability.

Risk Sensitivity (1 1/20)

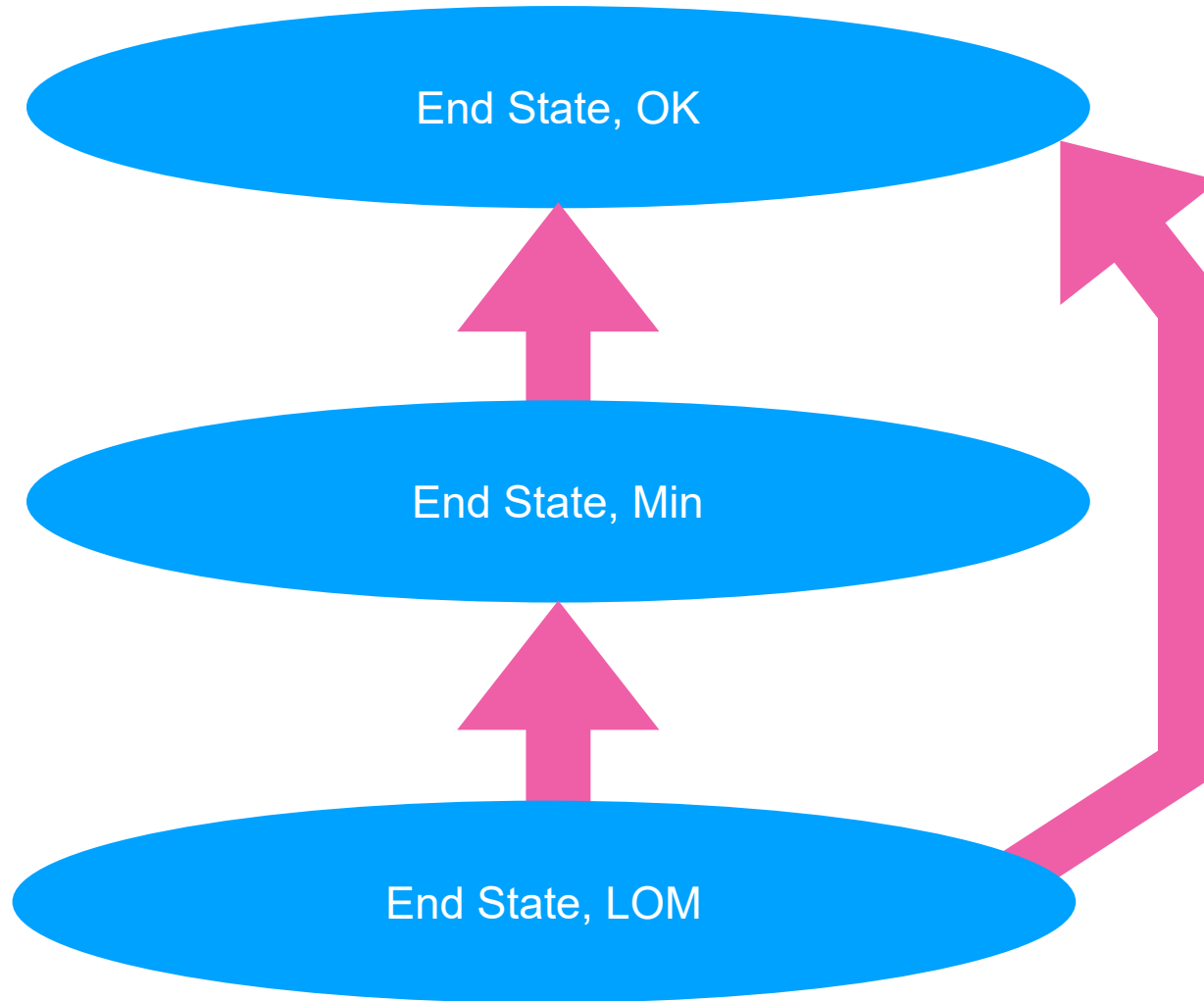

Risk Sensitivity (12/20)

- Assigning perfect reliability to a model leaf element will reduce $\text{Pr}(\text{LOM})$.
- Some scenarios contributing to $\text{Pr}(\text{LOM})$ will become scenarios contributing to $\text{Pr}(\text{OK})$. For example, a LOM scenario which contains only a single failure (e.g., loss of the Mothership radar or camera) will become an OK scenario if that failure is removed (because the leaf element failing in the reference mission is assigned perfect reliability).

Risk Sensitivity (13/20)

- Some scenarios contributing to $\text{Pr}(\text{LOM})$ will become scenarios contributing to $\text{Pr}(\text{Min})$. For example, a LOM scenario which contains two failures (e.g., loss of the flight system in one Elliptical platform and loss of the camera in the other) will become a Min scenario if one of the failures does not occur.
- Furthermore, some scenarios contributing to $\text{Pr}(\text{Min})$ will become scenarios contributing to $\text{Pr}(\text{OK})$. For example, a Min scenario which contains two failures (e.g., loss of the flight system in one Elliptical platform and one Areo platform) will become an OK scenario if flight systems have perfect reliability.

Risk Sensitivity (14/20)

- The probabilities for each end state must sum to unity.
 - If the total probability of those scenarios transitioning from LOM to Min exceeds the total probability of those transitioning from Min to OK, $\Pr(\text{Min})$ increases.
 - If the total probability of those scenarios transitioning from Min to OK exceeds the total probability of those transitioning from LOM to Min, $\Pr(\text{Min})$ decreases.
- Rather than attempting to decipher the sensitivity of $\Pr(\text{Min})$ to changes in leaf element reliability, a less obtuse view focuses on the probability that either OK or Min occurs.
- This probability is designated, $\Pr(\text{OK} \cup \text{Min})$.

Risk Sensitivity (15/20)

- $\Pr(\text{OK} \cup \text{Min})$ for the original risk model

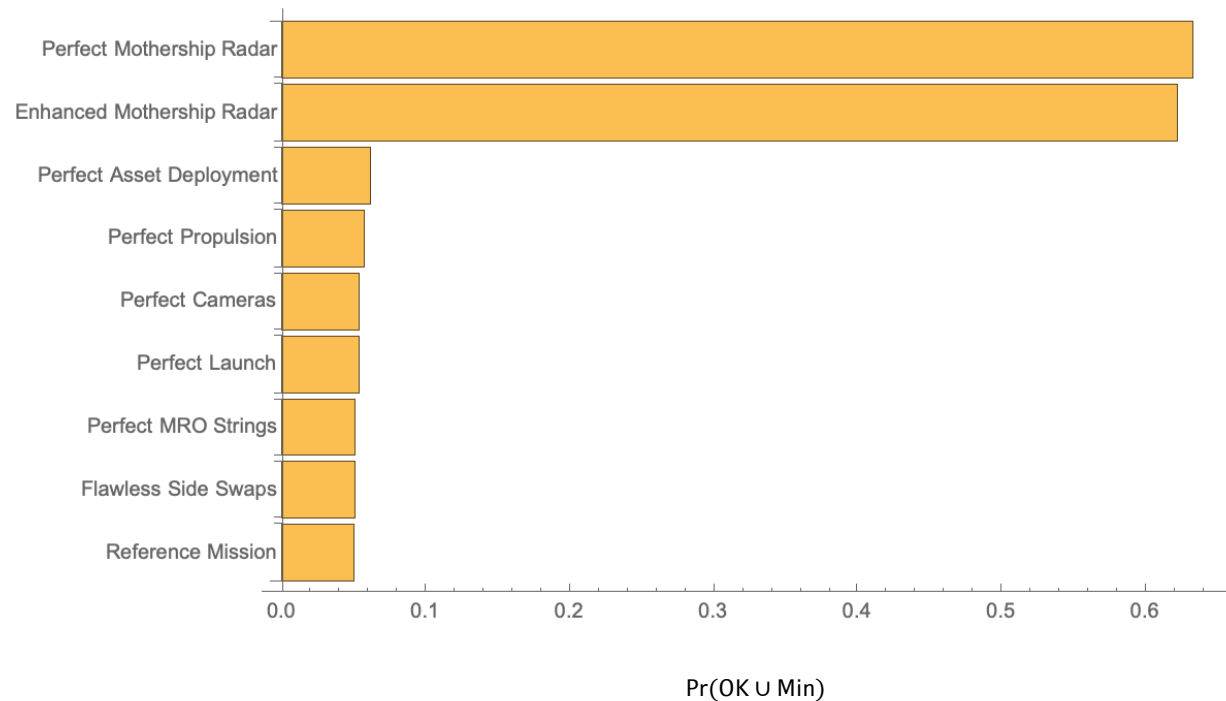

Risk Sensitivity (16/20)

- Enhancing Mothership radar reliability, or assigning it perfect reliability, has a drastic impact on $\Pr(\text{OK} \cup \text{Min})$.
- This is because loss of Mothership radar results in LOM according to the success criteria on Slide 5.

Risk Sensitivity (17/20)

- $\Pr(\text{OK} \cup \text{Min})$ when the Mothership has enhanced radar reliability

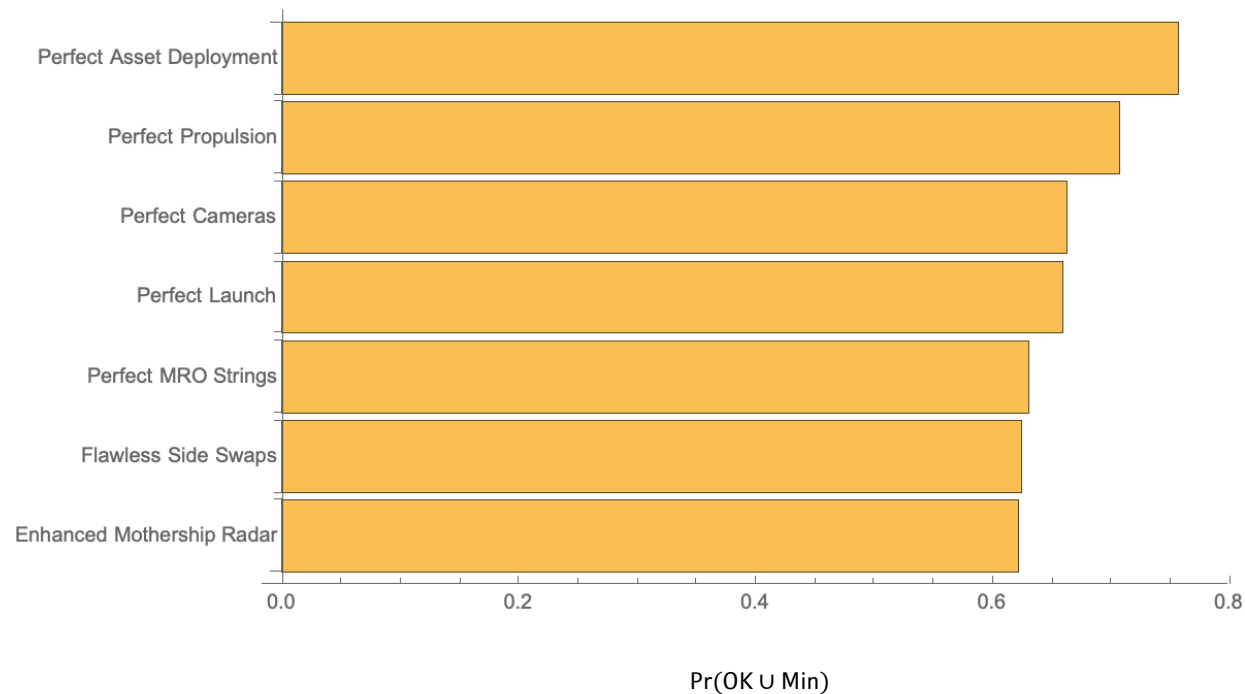

Risk Sensitivity (18/20)

- The previous slide's risk profile is fairly flat with respect to risk contributor ranking.
- Asset deployment and propulsion are the two most dominant risk contributors.
- If asset deployment and propulsion are each assigned perfect reliability, $\text{Pr}(\text{OK} \cup \text{Min})$ becomes 86.2% if the enhanced radar option is retained in the model.

Risk Sensitivity (19/20)

- The last sensitivity study examines $\Pr(\text{OK} \cup \text{Min})$ given perfect launch, cruise, and deployment. Perfect launch, cruise, and deployment means the operations phase begins with no model leaf element failed (e.g., one of the MRO strings in the Mothership flight system).
- This conditional probability is signified, $\Pr(\text{OK} \cup \text{Min} | \overline{F_0})$, where $\overline{F_0}$ denotes no model leaf element failure at the beginning of Mars operations.

Risk Sensitivity (20/20)

- $\Pr(\text{OK} \cup \text{Min}|\overline{F_0})$ when the Mothership has enhanced radar reliability
- This range of probability of success values (~ 0.9 to almost 1.0) is used in Section 3.4, constellation risk list

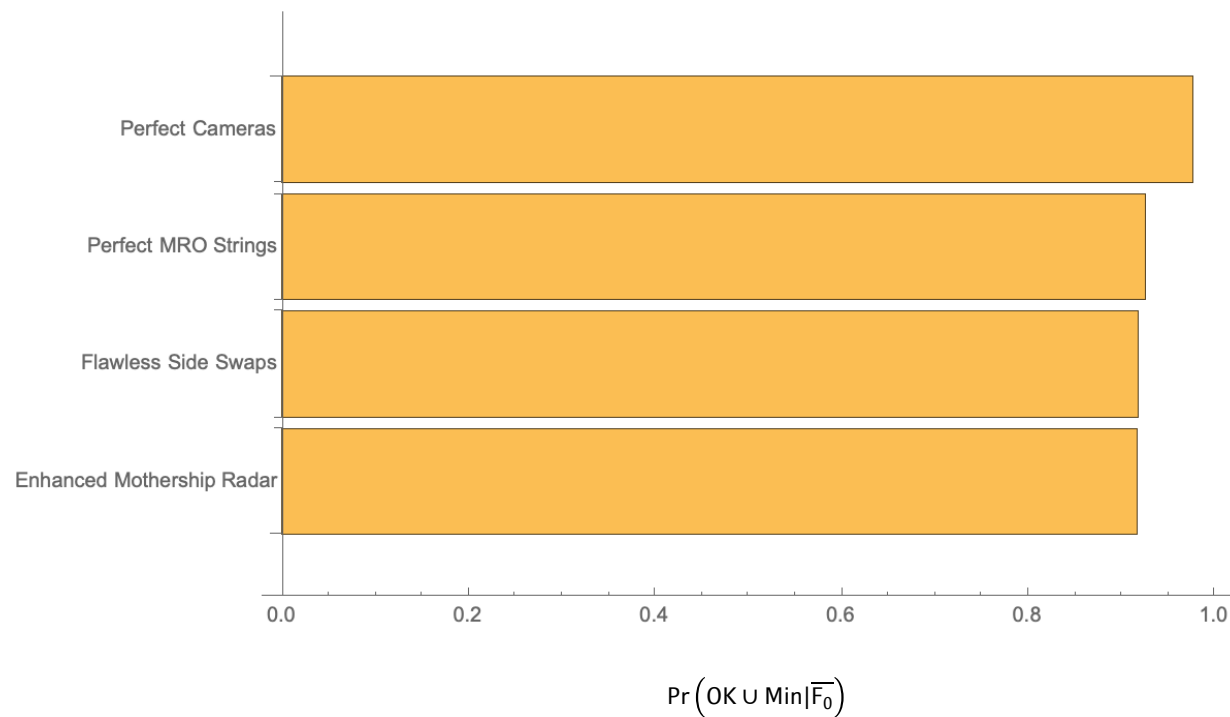

References (1/5)

1. https://en.wikipedia.org/wiki/Atlas_V (accessed June 9, 2020).
2. https://en.wikipedia.org/wiki/Delta_IV_Heavy (accessed June 9, 2020).
3. https://en.wikipedia.org/wiki/Falcon_9 (accessed June 9, 2020).
4. https://en.wikipedia.org/wiki/Beta_distribution#Bayesian_inference (accessed June 20, 2020).

References (2/5)

5. Saleh, J. H. et al, "Electric propulsion reliability: Statistical analysis of on-orbit anomalies and comparative analysis of electric versus chemical propulsion failure rates," *Acta Astronautica*, Vol. 139, October 2017, pp. 141-156.
6. [https://en.wikipedia.org/wiki/Dawn_\(spacecraft\)](https://en.wikipedia.org/wiki/Dawn_(spacecraft)) (accessed June 13, 2020).
7. <https://www.nasa.gov/centers/glenn/about/history/ds1opseq.html> (accessed June 13, 2020).

References (3/5)

8. Siu, N. O. and D. L. Kelly, “Bayesian parameter estimation in probabilistic risk assessment,” *Reliability Engineering and System Safety*, Vol. 62, Issues 1-2, 1998, pp. 89-116.
9. Box, G. E. P. and G. C. Tiao, Bayesian Inference in Statistical Analysis, John Wiley and Sons, Inc., New York, 1973.
10. Abelson, R. et al, *Juno Project Probabilistic Risk Assessment (PRA) Report*, (Redacted of Potential LM-Proprietary Information) July 2011.

References (4/5)

11. Denson, W. et al, *Nonelectronic Parts Reliability Data 1991*, Reliability Analysis Center, Rome, NY, NPRD-91, May 1991.
12. Unpublished notes from the ARRM down-select study PRA (circa. September 2014).
13. Chalupa, R., *Failure Modes, Effects and Diagnostic Analysis*, Report No. ROS 14-09-201 R001, Version V3, Revision R2, December 5, 2019.

References (5/5)

14. Yozallinas, J., *Failure Modes, Effects and Diagnostic Analysis*, Report No. ROS 13/06-005 R001, Version V2, Revision R0, June 2019.

Simplifying Assumptions for this Constellation Probability of Success High Level Analysis

- The mothership payload is simplified to a radar and a camera. This assumption is made since there is some relevant data about Earth-based radars, and some data about deep space cameras. Other payload instruments had no data to draw from.
- The mothership spacecraft is simplified to have two redundant strings of avionics. One is hot and the other is a cold backup. MRO data were used in this analysis.
- Launch, SEP cruise, SEP spiral down at Mars, and deployment were all assumed to work perfectly. Further analysis should be done in these areas in the future since it was beyond the scope of this study to analyze further.

C.4 Radio Occultation Simulations

The following pages provide the MOSAIC investigation radio science analysis.

MOSAIC



A PMCS study

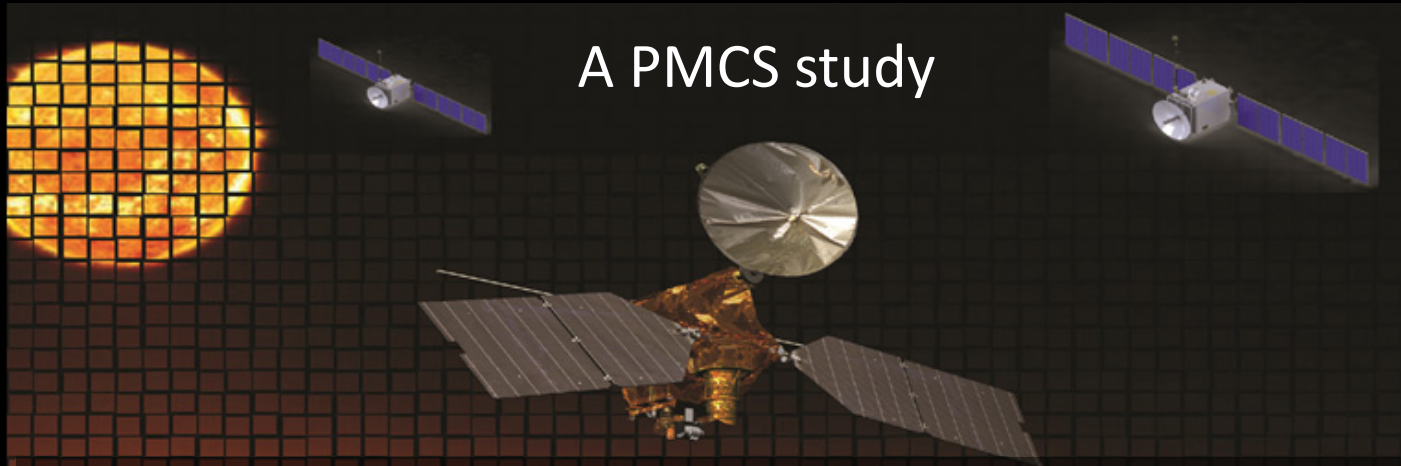

Radio Science (Supplementary Materials)

Chi O. Ao,
Sami Asmar, David Hinson, Paul Withers, ...

July 21, 2020

Introduction



- Radio links between the various MOSAIC orbiters provide great opportunities for observing the lower atmosphere and ionosphere via the technique of radio occultations, with unprecedented spatial and temporal coverages.

Earth-MRO, 14 days

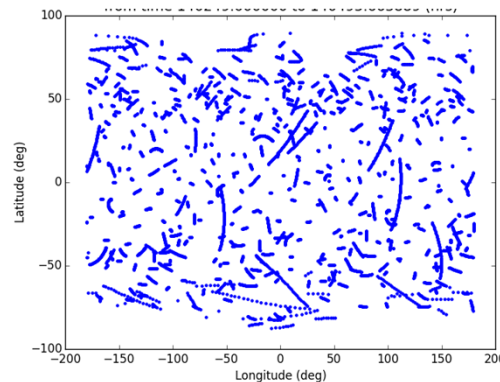
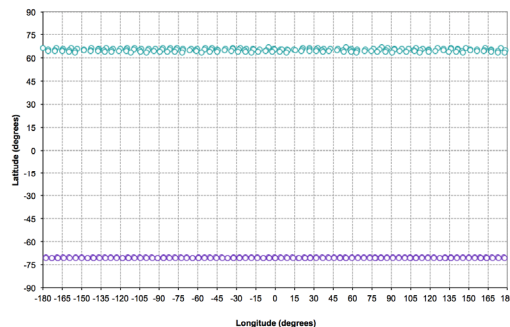

Simulated occultations
between Mars Orbiters
10 days

RO Measurement Characteristics (1)



- **Physical parameters:** RO measurements yield profiles of index of refraction with high vertical resolution
 - {density, T, P} vs geometric/geopotential height in the neutral atmosphere from 0 to 40 km (Inv 2, 3)
 - {electron density} vs height in the ionosphere from 100-250 km (Inv 5)
 - Also: ionospheric scintillation parameters from intensity and phase fluctuations (Inv 5)
- **What's being measured:** Time series of carrier phase (equivalently Doppler shifts of the carrier tone)
- **Resolution:**
 - High vertical resolution (~ 1 km, primarily noise limited)
 - Coarse horizontal resolution (~ 200 km due to limb sounding geometry)

RO Measurement Characteristics (2)



- **Unique features:**
 - self-calibrating (i.e., no external calibration needed)
 - Penetrates clouds, dust, aerosols
 - *simultaneous* sounding of the ionospheric and neutral atmosphere
- **Other needs:**
 - Ultra Stable clocks over 1-100 sec on both transmitter and receiver
 - Accurate reconstructed orbits (especially line-of-sight velocity) for retrievals
 - Orbit predicts needed to schedule occultations in advance
- **What frequencies?**
 - We need 2 frequencies to sense both neutral and ionosphere:
 - Neutral atmosphere is non-dispersive over radio frequencies so choice of frequency depends on instrumentation/accommodation (what gives the best phase precision), e.g., Ka or X-band.
 - Ionosphere is dispersive, refractivity $\sim n_e/f^2$ so there is an advantage for choosing lower frequencies, e.g., UHF or S-band.

Measurement Requirements



- Performance: main contributing factors
 - Thermal noise
 - Clock drifts (small with $1.e-13$ USO baseline)
 - Orbit accuracy (< 0.2 mm/s in velocity, 30 m in position)
- Coverage
 - Dependent on transmitter and receiver orbits (up to 24 possible between two orbiters for ~ 120 min orbit under favorable conditions)

Ultra-Stable Oscillators



- A USO is required on both ends of the link
 - DSN has H-maser for classical uplink or downlink
- Class of USO: $\sim 1 \times 10^{-13}$ Allan deviation (at 10 seconds) for best scientific results
- Common for deep space missions: MGS, Cassini, GRAIL, New Horizons, etc.
 - Voyager/Galileo era had one order of magnitude less stable; best at the time
- GRAIL/GRACE examples of spacecraft-to-spacecraft crosslinks
 - USO on each spacecraft
- Mass & power estimates: 1.5 kg, 3 W (steady-state)
- JPL is exploring miniaturization with manufacturers

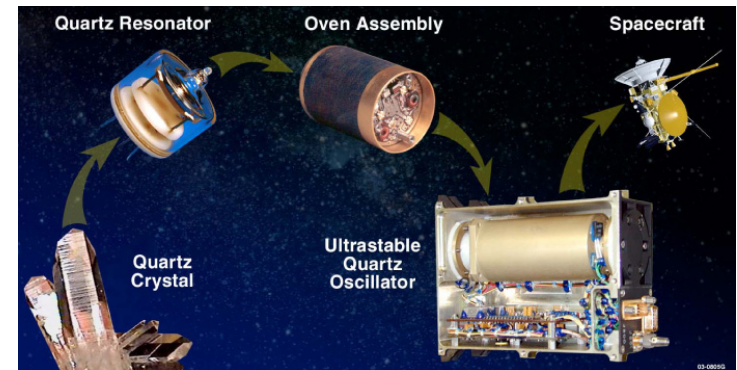

Observational Constraints



- The transmitter and receiver are in view of each other, with line-of-sight altitudes moving vertically from below the surface to the top of the atmosphere/ionosphere.
- The best RO observations are “in-plane” occultations where the LOS vector is within the orbital plane. This minimizes the horizontal drift of the tangent points across different altitudes.
- Thus the antennas are typically designed for maximum gains in the velocity and anti-velocity directions with an azimuth FOV $\sim \pm 60$ deg from boresight.

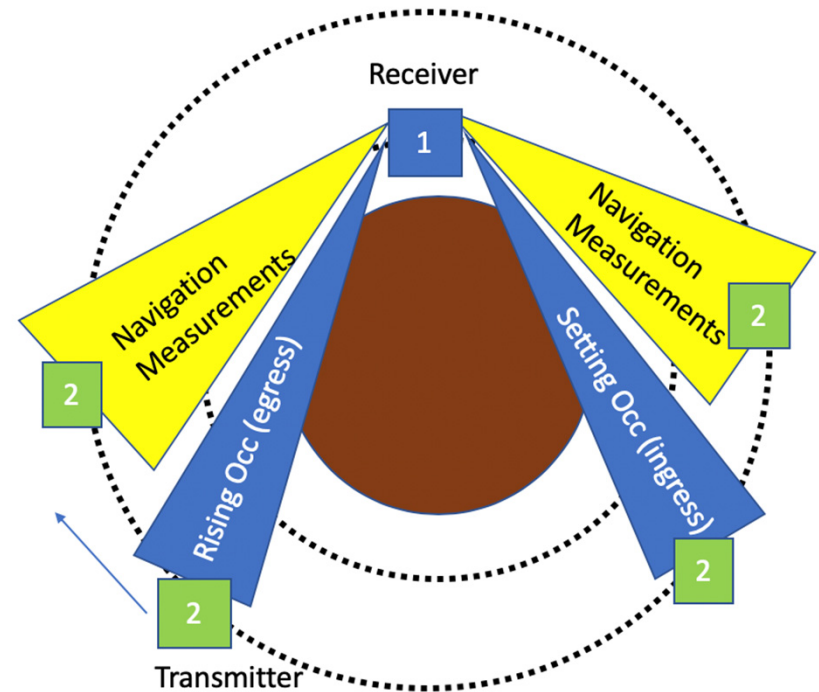

Coverage Simulations (Polar-Polar)



4 polar orbiters

93 deg inclination

350 km altitude

Ascending/descending nodes:

0, 6, 12, 18 am/pm

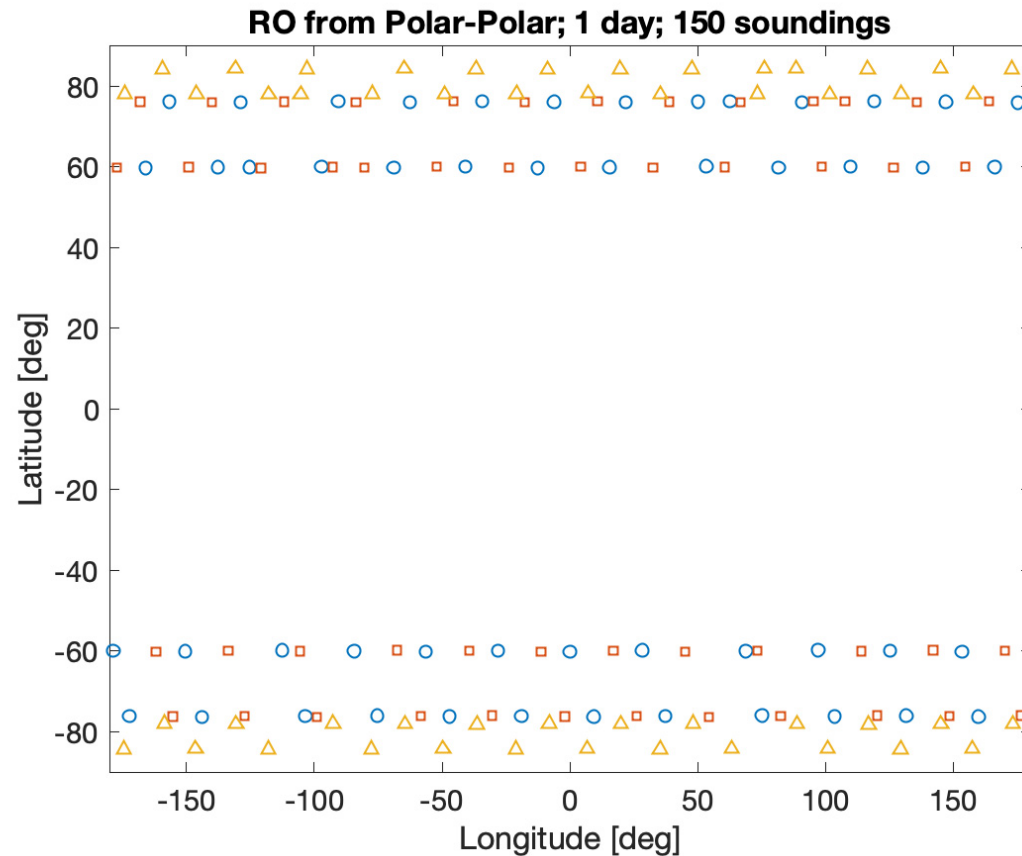

Coverage Simulations (Elliptical-Polar)



4 polar orbiters

93 deg inclination

350 km altitude

Ascending/descending nodes:

0, 6, 12, 18 am/pm

1 elliptical orbiter

75 deg inclination

150 km x 7000 km

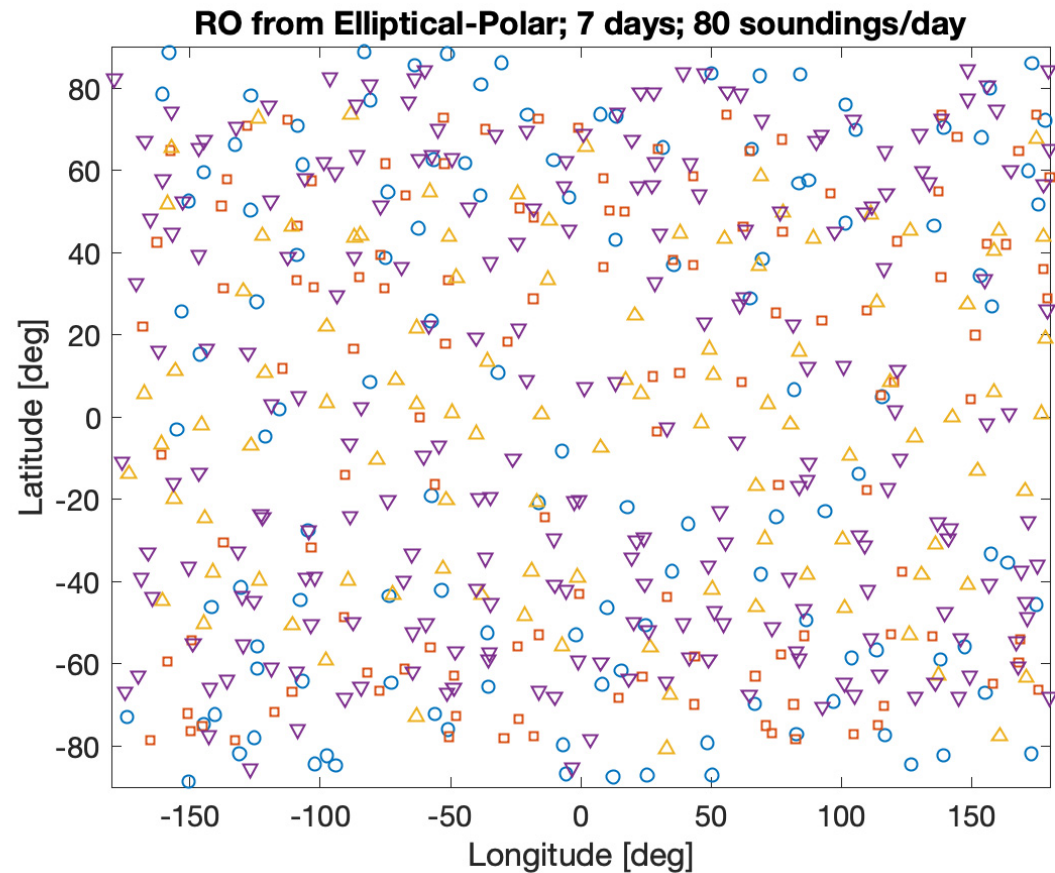

Data Volume/Rate



- 10 kHz (open loop), 8 bits per sample (I, Q), 10 min
 - > **96 Mb/occ (high end)**
 - Sample rate can be significantly reduced (< 1 kHz) with some knowledge of the orbits (modeling the doppler shift due to orbital motion) (NB: 50-100 Hz typically used in GPS-RO). Assuming 100 Hz is sufficient:
 - > **0.96 Mb/occ (low end)**
- Assume 150 occ/day (baseline requirement)
 - > **2–200 kb/s (choose 20 kb/s for mission design)**

ConOps



- RO instrument can be put in standby mode if needed when not occulting.
- RO instrument will be turned on ~ 5 min before ingress and 5 min after egress to collect low rate data (1 Hz) for orbit determination. ~10 min of occultation data collection (high rate).
- Pointing may or may not be required (depends on antenna).

Instrument Requirement



<u>RO Configuration</u>	<u>Link</u>	<u>Performance</u>	<u>Hardware</u>	<u>Status</u>
SmallSat-to-SmallSat	Ka-band & UHF	Carrier SNR > 40 dB	Transponder	JPL UST Lite
(Carrier Only)	<i>(assuming mass & power constraints allow)</i>	<i>Initial estimate</i>	Antenna (x2)	Commerical
		Allan Dev. $ee-13$	SSPA (x2)	Commerical
			USO	Commercial

SSPA: solid-state power amplifier



RO Link Budget Analysis at UHF and X Bands between Elliptical and Polar Orbiters in the MOSAIC Constellation

Ionospheric occultation at UHF

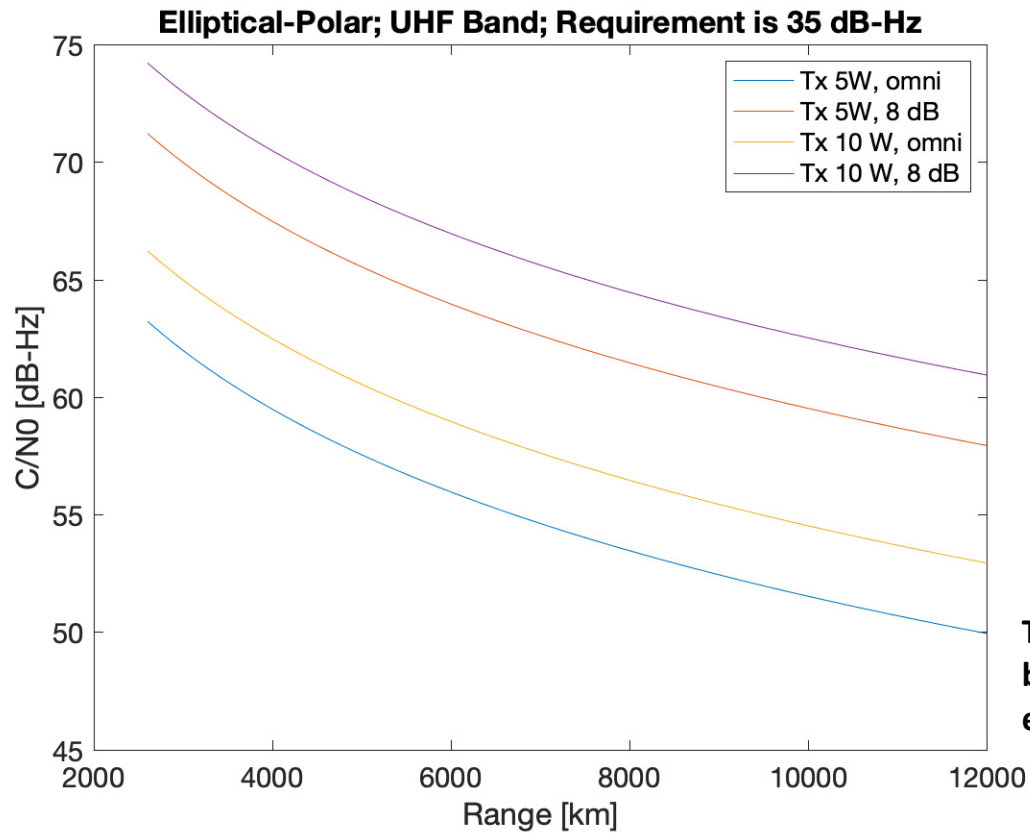

The requirement of 35 dB-Hz can be easily met over the entire elliptical orbit.

Atmospheric occultation at X

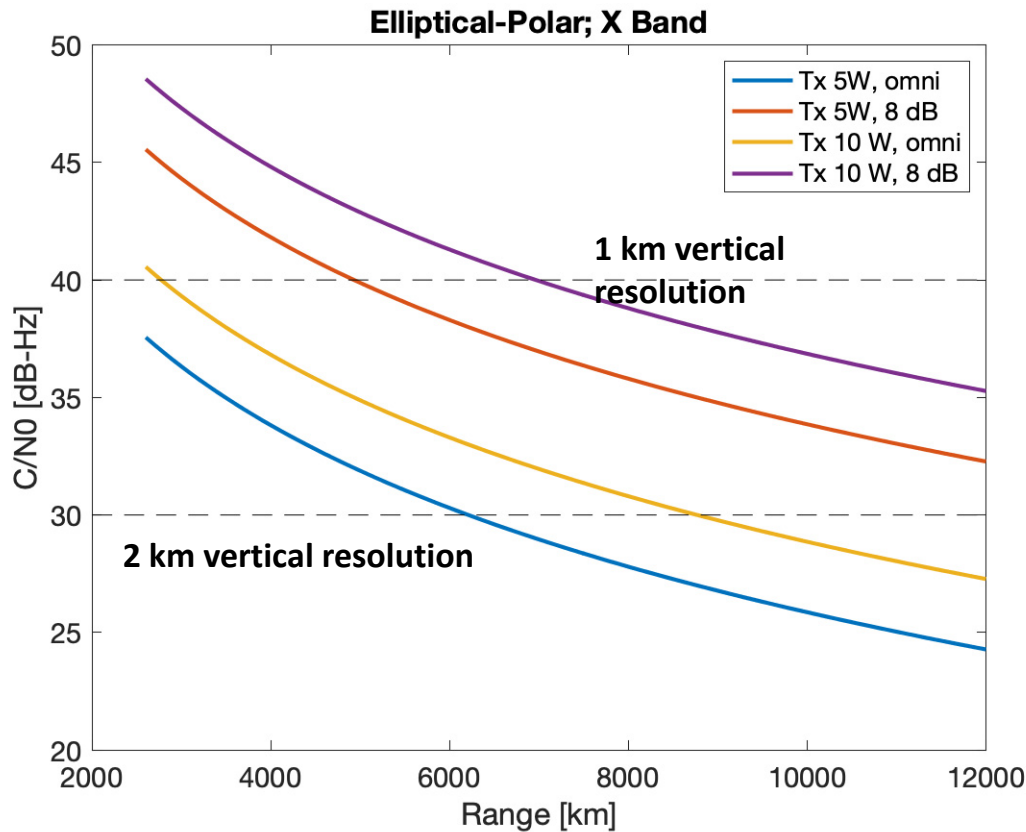

At 1 km vertical resolution, requirement is 40 dB-Hz.

This drops to 30 dB-Hz at a lower resolution of 2 km.

With omni transmit antenna from the elliptical orbiter at 5 (10) W, range must be less than 6000 (8500) km to meet the 2 km vertical resolution requirement.

This translates to 20 (40) occultations per day between 1 elliptical and 4 polar orbiters that meet the requirement.

Number of occ between 1 elliptical and 4 polar orbiters as a function of range

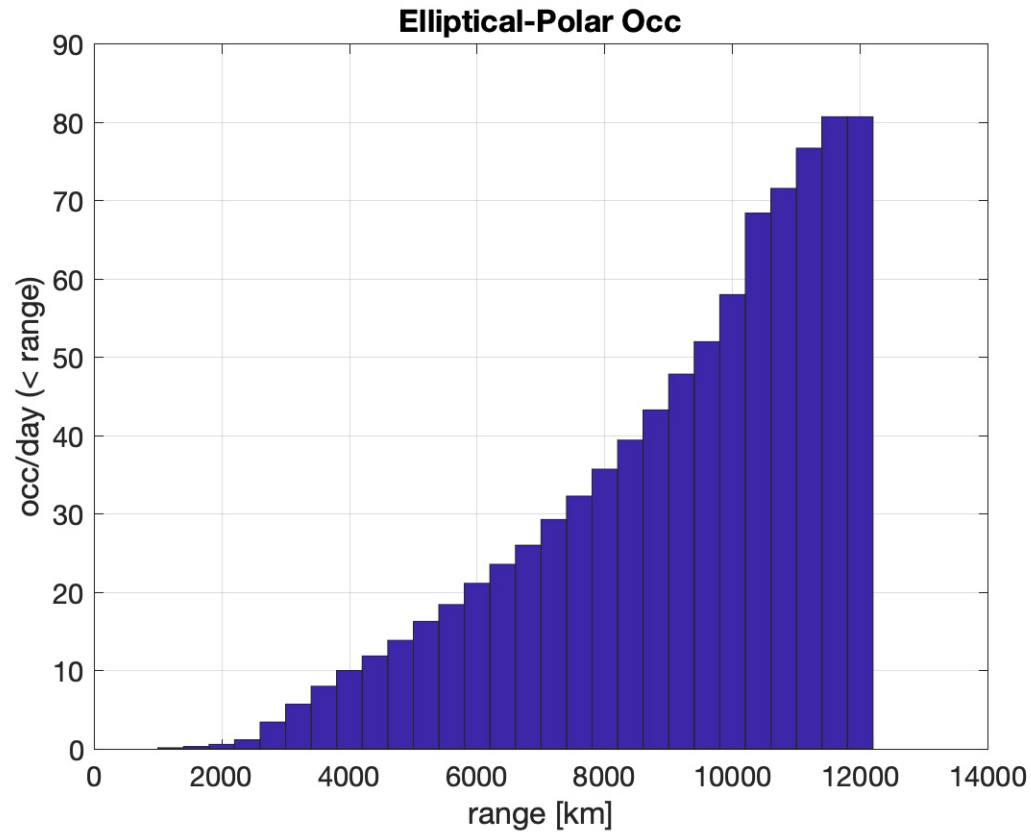



Analysis of How the Spinning Elliptical Configuration Would Impact Number of RO Soundings between Elliptical Spinner and Polar Orbiters

MOSAIC Radio Occultations from the Elliptical Orbiter (1) to the Polar Orbiters (4)

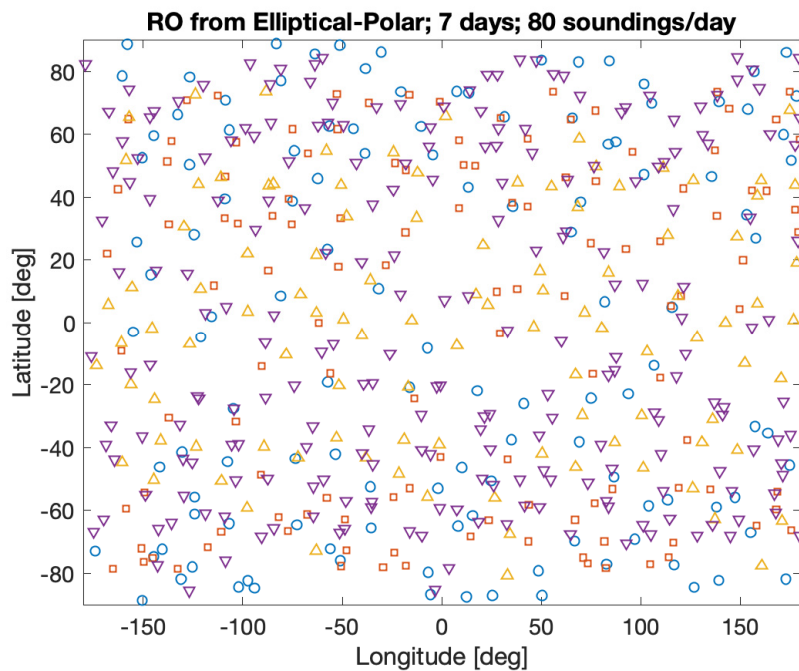

The coverage shown was obtained assuming omnidirectional transmission from the elliptical orbiter.

- Assuming 50 deg half angle cones in fore and aft directions reduce it by $\sim (1-\cos(50^\circ)) \sim 0.36$.
- For the spinners with antennas on both ends of the spin axis, occultations are possible only when the spin axis is sufficiently aligned with the spacecraft velocity vector. For a $\pm 45^\circ$ cutoff, the reduction is about 50%.

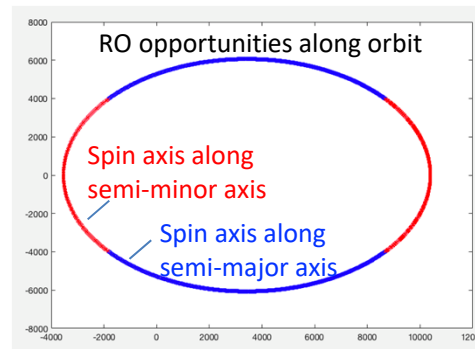

Thus we expect a total reduction of $0.36 \cdot 0.50 \sim 0.20$, i.e., from 80 soundings per day to **16 soundings per day**.

Appendix D Additional Information on Technologies and Techniques

Preface

- Payloads chosen for the Team X studies (Appendix B.3 to B.5) might differ from the ideal payloads envisioned by the MOSAIC science team. These differences are due to availability of necessary information for entrance into Team X as well as the fact that the MOSAIC study team continued to refine the notional payloads after the point design study. It is noted in the text where these differences arise. The payloads described in the Team X documents are intended as a roadmap to MOSAIC science, where other reasonable alternatives exist or are in development.
- The main body (Section 1-5) of the MOSAIC final report takes precedence over information in the Appendix where conflicts, omissions, or errors exist.
- See Table B-1 in Appendix B for clarification of MOSAIC Baseline Constellation, MOSAIC Descope 1 Constellation, MOSAIC Mothership, and MOSAIC Mini-Mothership with respect to JPL Team X design study options.

Contents

D.1 MOSAIC Quad Charts	D-3
D.2 MOSAIC Platform Summary.....	D-4
D.3 Spacecraft Technology	D-5
D.3.1 Delay Tolerant Network	D-5
D.3.2 Deep Space Optical Communication.....	D-7
D.4 Instrument Technology	D-9
D.4.1 Polar-SAR and Sounder Hybrid Instrument.....	D-9
Polar-SAR and Sounder Onboard Compression	D-10
D.5 Additional Cost Model Techniques Information.....	D-12
D.5.1 Wrap Factors.....	D-17
D.5.2 SEER-H.....	D-17
D.5.3 True Planning	D-21
D.5.4 Space Operations Cost Model (SOCM)	D-24
D.5.5 SSCM14	D-25
D.5.6 Elliptical SmallSats Additional Validation	D-27

Figures

Figure D-1. Solar System Internet Working with DTN.....	D-6
Figure D-2. NASA DTN technology roadmap.....	D-7
Figure D-3. Operational view of DSOC technology demonstration.....	D-8
Figure D-4. MOSAIC block diagram for hybrid SAR and sounder.	D-10
Figure D-5. Mars Missions vs MOSAIC \$/kg.	D-17
Figure D-6. SOCM Level 1 Cost Input for MOSAIC Phase E (MOSAIC Baseline Constellation).....	D-25

Tables

Table D-1. MOSAIC Mothership Platform. Key: B = Science Baseline, T = Science Threshold, Cost = \$FY20, QC = Quad Chart.....	D-4
--	-----

Table D-2. MOSAIC Areo Carrier Platform. Key: B = Science Baseline, T = Science Threshold, Cost = \$FY20, QC = Quad Chart.....D-4

Table D-3. MOSAIC Areo SmallSat A Platform. Key: B = Science Baseline, T = Science Threshold, Cost = \$FY20, QC = Quad Chart.....D-4

Table D-4. MOSAIC Areo SmallSat B Platform. Key: B = Science Baseline, T = Science Threshold, Cost = \$FY20, QC = Quad Chart.....D-5

Table D-5. MOSAIC Polar Platform. Key: B = Science Baseline, T = Science Threshold, Cost = \$FY20, QC = Quad Chart.....D-5

Table D-6. MOSAIC Elliptical Platform. Key: B = Science Baseline, T = Science Threshold, Cost = \$FY20, QC = Quad Chart.....D-5

Table D-7. DSOC technology roadmap.....D-9

Table D-8. MOSAIC Processed Image Data Rate for the Polar-SAR instrument at 30 m/pixel. .D-11

Table D-9. MOSAIC Processed Image Data Rate for the Polar-SAR instrument at 100 m/pixel. ...D-11

Table D-10. MOSAIC Processed Image Data Rate for the Sounder instrument.D-11

Table D-11. Cost model results for MOSAIC Mothership (FY25 \$M). Highlighted cells represent **Wrap** and **SOCM**.D-13

Table D-12. Cost model results for MOSAIC Mini-Mothership (FY25 \$M). Highlighted cells represent **Wrap** and **SOCM**.D-14

Table D-13. Cost model results for MOSAIC Baseline Constellation (FY25 \$M). Highlighted cells represent **Wrap**, **SSCM**, and **SOCM**.D-15

Table D-14. Cost model results for MOSAIC Descope 1 Constellation (FY25 \$M). Highlighted cells represent **Wrap**, **SSCM**, and **SOCM**.D-16

Table D-15. Historical wrap factors for WBS 04, 07 and 09D-17

Table D-16. MOSAIC SEER-H Setting and Model Inputs for Mothership and Mini-Mothership Spacecrafts.....D-18

Table D-17. MOSAIC TruePlanning high level setting for different mission classes.....D-21

Table D-18. MOSAIC TruePlanning Setting and Model Inputs for Mothership and Mini-Mothership Spacecrafts.....D-22

Table D-19. Model Inputs Settings for MOSAIC’s Areo/Polar/Elliptical SmallSats platforms....D-26

Table D-20. MOSAIC Elliptical vs THEMIS SmallSats Validation (FY25 \$M).....D-27

D.1 MOSAIC Quad Charts

The MOSAIC quad charts (on the following pages) provide the connection between Investigation 1–8 (Appendix B.1.3.1-Appendix B.1.3.8) and the instruments (Appendix B.1.4) (also see Instrument Requirements Definition in Appendix B.1.6). The instrument list provided in the MOSAIC quad charts contains instruments included in the MOSAIC Baseline Constellation payload (**green dot** at top left of quad chart) and instruments not included in the MOSAIC Baseline Constellation payload (**red dot** at top left of quad chart).

Investigation 1: Subsurface and Surface Ice



- included in baseline payload
- not included in baseline payload

1

P-band SAR + Sounder



Why measure ice content?

- Determine bulk ice content in upper 3-5 m of regolith for ISRU & investigate ice exchange with atmosphere

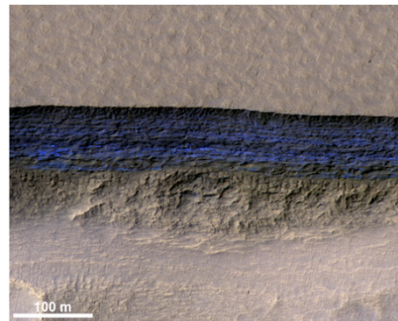

MOSAIC Objectives: IA, IIA

Resources/accommodations

Platform (order)	Mothership	
# platforms	Threshold: 1	Baseline: 1
Mass	90 kg	
Power (incl heat)	Max 500 W	
Data Rate	Threshold: 0.25-2.75 Mbps for SAR	Threshold: 2.3 Mbps for sounder
Swath width	25 km on the ground	
Keep out zones	N/A	
ConOps	Two measurement modes required: a high-rate mode for regions of interest (30-60° latitude, at all longitudes) at 30 m resolution, and a low-rate mode for other regions at 100 m. Threshold: Seasonal low-rate mosaic from 30° poleward in each hemisphere. Baseline: Full high-rate mosaic 2x/Mars year for 50° poleward at the beginning of spring and 80° poleward in mid-summer.	

Measurement Requirements

Physical Parameter/ Observable Quantity	Wavelength	Vertical Resolution
Surface backscatter + bulk dielectric permittivity (near-surface moisture content)	400 MHz	1.5 m in free space (0.85 m in pure water ice)

TRL story/development required

Current TRL	8-9
Heritage	ESA Biomass (SAR) + SHARAD (sounder)
\$ to TRL 5	N/A
Time to TRL 5	N/A
\$ TRL 5 to 6	N/A
Time TRL 5 to 6	N/A
Notes:	

Mars Atmos., Volatile and Resource Investigation Camera



Why monitor global weather?

- Monitor daily global weather and ice coverage
- Distinguish surface H₂O and CO₂ ice
- Limb-views possible for cloud heights

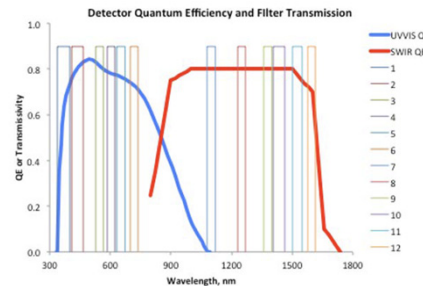

Resources/accommodations

Platform (order)	M	
# platforms	Threshold: 1	Baseline: 1
Mass	1 kg (camera), 2.4 kg (electronics)	
Power (incl heat)	2.1 W (camera), 8.2 W (electronics)	
Data Rate	Threshold: 102 kbps	Baseline: 127 kbps
FOV	150°	
Keep out zones	Don't point near Sun	
ConOps	Push-frame imaging, off/on as needed	

MOSAIC Objectives: I.A., II.A., I.B, I.C.a, II.B.

Measurement Requirements

Physical Parameter/ Observable Quantity	Water Ice Cloud Extent	Dust Cloud Extent
Altitude Range	0-90 km	0-90 km
Precision	SNR 7-85	SNR 7-85
Horizontal Resolution	<1 km at nadir	<1 km at nadir
Vertical Resolution	~3 km at the limb	~3 km at the limb

TRL story/development required

Current TRL	All components 7 except near-IR arrays (TRL 5)
Heritage	MARCI, Parker Solar Probe WISPR
\$ to TRL 5	N/A
Time to TRL 5	N/A
\$ TRL 5 to 6	TBD
Time TRL 5 to 6	~1 year, near-IR array needs space qualification
Notes:	Developed through JHUAPL IRADs

Investigation 2: Lower and Middle Atmosphere



- included in baseline payload
- not included in baseline payload

2

AMCS limb infrared radiometer



Objectives:

- Characterize volatile cycling
- Characterize structure and dynamics of lower-middle atmosphere
 - Meso- to global scales
 - Seasonal variability
- Characterize Martian weather for operational purposes



MOSAIC Objectives: I.A, I.B, I.C, II.B

Resources/accommodations

Platform (order)	M	
# platforms	Threshold: 1	Baseline: 1
Mass	9 kg	
Power (incl heat)	18 W avg	
Data Rate	Threshold: 4 kbps	Baseline: 4 kbps
FOV	FOV 70 mrad, IFOV 1.8 mrad	
Keep out zones	No Sun in FOV	
ConOps	Always on, self pointing on a nadir platform	

Measurement Requirements

Physical Parameter	Range, accuracy, resolution	Observable Quantity
Temperature profile	120-270 K, 2 K accuracy, 0-80 km altitude, 2-3 km vertical resolution	Radiance profiles around 15 μm (3 or 4 channels)
Dust, water ice, CO ₂ ice profile	10 ⁻⁵ -10 ⁻² km ⁻¹ , 0-80 km altitude, 2-3 km vert. res.	Radiance profile at 12, 22, 32 μm
Water vapor profile	10-1000 ppm, 10 ppm accuracy, 0-20 km altitude, 2-3 km vert. res.	Radiance profile at 42 μm , wide and narrow-band measurement
Surface temperature	100-300 K, 0.5 K accuracy	Surface radiance at 32 μm

TRL story/development required

Current TRL	9
Heritage	MRO MCS
\$ to TRL 5	N/A
Time to TRL 5	N/A
\$ TRL 5 to 6	N/A
Time TRL 5 to 6	N/A
Notes:	

Mars Lidar for Atmospheric Studies (MARLI)



Why measure atmospheric wind?

- Key to understanding atmospheric transport of dust/water/volatiles
- Direct measurement of atmospheric circulation
- Understand hazard to surface launch (MSR) and human exploration

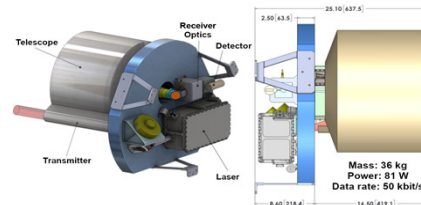

MOSAIC Objectives: I.A-C, II.B.

Resources/accommodations

Platform (order)	M	
# platforms	Threshold: 1	Baseline: 1
Mass	36 kg (fixed pointing), + ~9 kg with gimbal	
Power (incl heat)	81 W operating (fixed)	91 W operating (gimballed)
Data Rate	Threshold: 25 kbps	Baseline: 50 kbps
FOV	~60 μ rad, 30° off nadir (rotating if gimballed)	
Keep out zones	Keep telescopes out of direct Sun	
ConOps	90% on duty cycle, could be turned on/off as needed	

Measurement Requirements

Physical Parameter/ Observable Quantity	Wind (u,v)	Aerosol Opacity
Altitude Range*	0-40 km	0-40 km
Precision	~2 m/s	2-5% dust; 3-10% water ice
Horizontal Resolution	20 m x 3 km	20 m x 3 km
Vertical Resolution	~2 km	~2 km

* Variable based on aerosol conditions

TRL story/development required

Current TRL	6 by June 2020
Heritage	MOLA, LOLA. Developed with PICASSO and MATISSE
\$ to TRL 5	N/A
Time to TRL 5	N/A
\$ TRL 5 to 6	N/A
Time TRL 5 to 6	N/A
Notes:	Single-pointing is developed. Gimballed version desired.

Sub-mm sounder



Vertical Profiles of Wind, vapor, T, trace gases

- Wind profiles from 11-80+ km, with ~6-9 km vertical resolution; < 15 m/s for single profile
- Water vapor profiles from 0-80 km, with 3 km vertical resolution; < 9 ppm precision from 0-50 km; <20 ppm above that
- HDO (deuterated water) precision <0.1 ppm precision from 0-50 km; 3 km vertical resolution (allows 500 per mil precision averaged over $L_s = 15^\circ$)
- T profiles from 0-80 km with 4-10 km vertical resolution; <2 K precision for single profile
- Day and night measurements under high and low optical depth conditions

MOSAIC Objectives: I.A and I.B

Resources/accommodations

Platform (order)	M	
# platforms	Threshold: 1	Baseline: 1
Mass	35 kg (2 antenna system)	
Power (incl heat)	39 W avg	50 W peak
Data Rate	Threshold: 10 kbps	Baseline: 40 kbps
FOV	Two 0.1° beams (2.5 km at limb), each independently steerable over 180° in azimuth, and between 12° and 32° below the “horizontal” in elevation for 300 km orbit	
Keep out zones	No physical interference in FOV	
ConOps	Always on and scanning, 100 Gb onboard storage	

Measurement Requirements

Physical Parameter/ Observable Quantity	Thermal emission spectrum from limb, centered near 450 GHz
Spectral bandwidth	3 GHz
Spectral resolution	300 kHz near line centers
System noise temperature	1100 K
Cadence	Limb scan 0-150 km every 76 s, provides 4° sampling; adjustable
Assumptions	~300 km, near-polar orbit

TRL story/development required

Current TRL	5
Heritage	Aura MLS, HiFi, Rosetta, MIRO, 3 GHz CMOS spectrometers from cell phone industry
\$ to TRL 6	\$50 K (SEU testing on the ASIC chips)
Time to TRL 6	3-6 months
Notes:	

Sub-mm additional info



Below: Sub-mm instrument graphic.

Right: (Heavy curves) Precision and resolution. (Light curves) Assumed profiles. (Dots) Improved LOS wind speed when coarser vertical resolution is used.

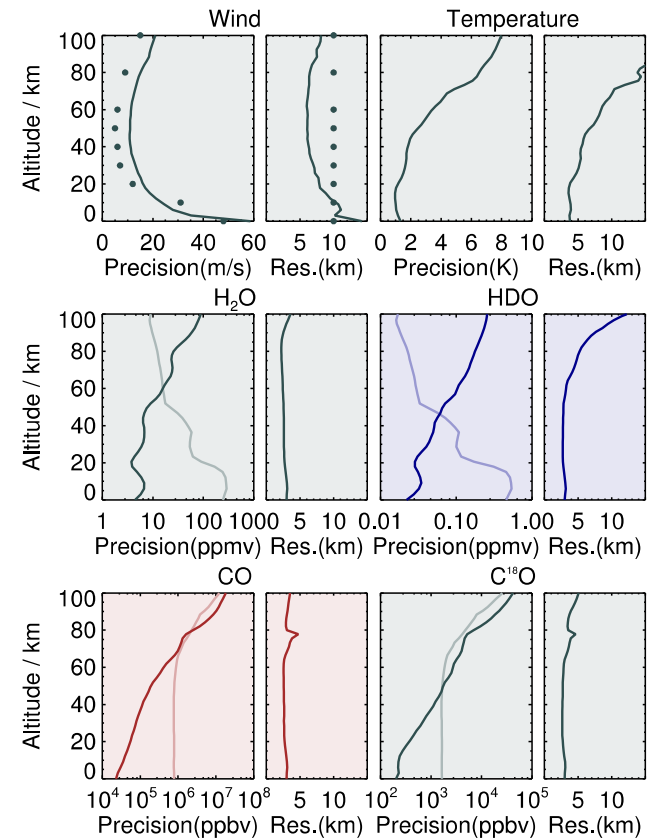
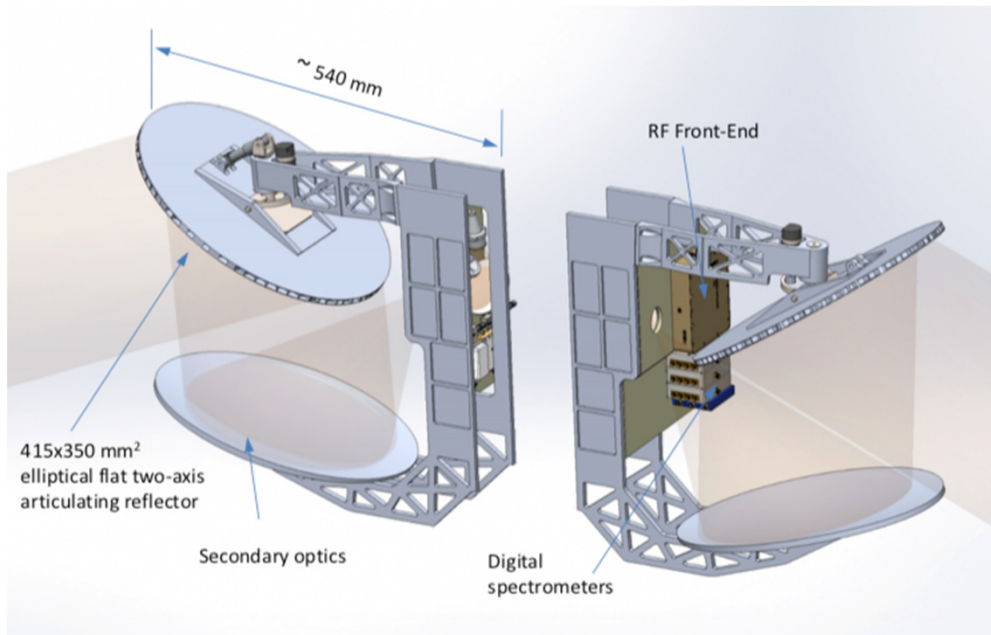

Orbiting Planetary Atmospheric Lidar (OPAL)



Why profile lower/middle atmosphere?

- Fundamental to study of lower atmospheric processes
- Constrain dust/volatile exchange between atmosphere and geosphere
- Dust storm, hazards, human EDL/surface ops

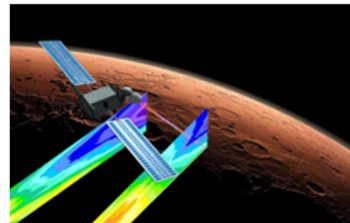

Figure 4. OPAL operation in orbit. OPAL beam is pointed to 2 fore and 2 aft directions making two sheets of measurements in the atmosphere.

MOSAIC Objectives: I.A-C, II.B.

Resources/accommodations

Platform (order)	M	
# platforms	Threshold: 1	Baseline: 1
Mass	40 kg	
Power (incl heat)	45 W min	55 W peak
Data Rate	Threshold: 5 kbps	Baseline: 139 kbps
FOV	~0.1 mrad, 30° off nadir, azimuth ($\pm 60^\circ$), fore/aft	
Keep out zones	None	
ConOps	Could be turned on and off as needed	

Measurement Requirements

Physical Parameter/ Observable Quantity	Wind (u,v,w)	Aerosol Opacity	Temperature	Density
Altitude Range*	0-50 km	0-50 km	0-50 km	0-50 km
Precision	1 m/s	1% up to 2.5/km	5 K	5%
Horizontal Resolution	10 km	10 km or less	10 km	10 km
Vertical Resolution	1-3 km	1-3 km	1-3 km	1-3 km

* Shifts higher in high aerosol conditions; 50-100 km column average T/density as well

TRL story/development required

Current TRL	3
Heritage	New Frontiers/ALHAT etc.
\$ to TRL 5	\$3 M
Time to TRL 5	3 years
\$ TRL 5 to 6	\$5 M
Time TRL 5 to 6	2 years
Notes:	Laser pulse amplifier and non-mech beam steering, lowest TRL (3). Alternative to MARLI.

Investigation 3: Diurnal Lower Atmosphere



- included in baseline payload
- not included in baseline payload

3

Mini-MCS infrared radiometer: Polar Platform



Objectives:

- Characterize volatile cycling
- Characterize structure and dynamics of lower-middle atmosphere
 - Meso- to global scales
 - Diurnal and seasonal variability
- Characterize Martian weather for operational purposes

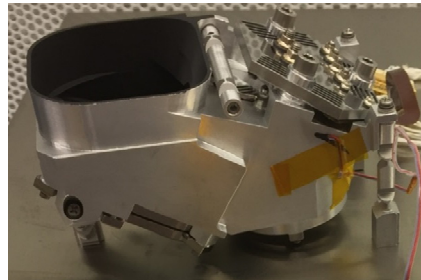

MOSAIC Objectives:
I.A, I.B, I.C, II.B

Resources/accommodations

Platform (order)	P	
# platforms	Threshold: 1	Baseline: 3
Mass	3.5 kg	
Power (incl heat)	8 W avg	
Data Rate	Threshold: 2 kbps	Baseline: 4 kbps
FOV	FOV 70 mrad, IFOV 1.8 mrad	
Keep out zones	No Sun in FOV	
ConOps	Always on, platform provides pointing control	

Measurement Requirements

Physical Parameter	Range, accuracy, resolution	Observable Quantity
Temperature profile	120-270 K, 2 K accuracy, 0-80 km altitude, 2-3 km vertical resolution	Radiance profiles around 15 μm (3 channels)
Dust, water ice, CO ₂ ice profile	10 ⁻⁵ -10 ⁻² km ⁻¹ , 0-80 km altitude, 2-3 km vert. res.	Radiance profile at 12, 22, 32 μm
Water vapor profile	10-1000 ppm, 10 ppm accuracy, 0-20 km altitude, 2-3 km vertical resolution	Radiance profile at 42 μm , wide and narrow-band measurement
Surface temperature	100-300 K, 0.5 K accuracy	Surface radiance at 32 μm

TRL story/development required

Current TRL	6
Heritage	MRO MCS
\$ to TRL 5	N/A
Time to TRL 5	N/A
\$ TRL 5 to 6	N/A
Time TRL 5 to 6	N/A
Notes:	

Mini-MCS infrared radiometer: Areostationary



Objectives:

- Characterize volatile cycling
- Characterize structure and dynamics of lower-middle atmosphere
 - Meso- to global scales
 - Diurnal and seasonal variability
- Characterize Martian weather for operational purposes

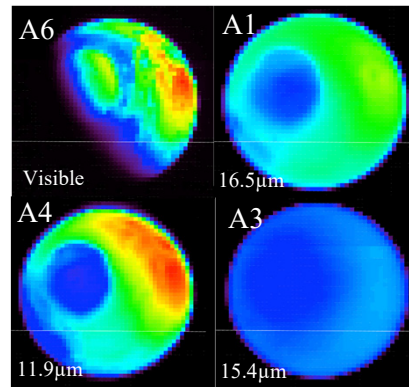

MOSAIC Objectives: I.A, I.B, I.C, II.B

Resources/accommodations

Platform (order)	A	
# platforms	Threshold: 3	Baseline: 4
Mass	3.5 kg (may be slightly higher depending on mirror)	
Power (incl heat)	8 W avg	
Data Rate	Threshold: 4 kbps	Baseline: 4 kbps
FOV	FOV 70 mrad, IFOV 1.8 mrad	
Keep out zones	No Sun in FOV	
ConOps	Always on, flip mirror(s) for disk raster scan	

Measurement Requirements

Physical Parameter	Range, accuracy, resolution	Observable Quantity
Temperature profile	120-270 K, 2 K accuracy, 0-40 km altitude, 10 km vert. res. (~1 scale height)	Radiance soundings around 15 μm (3 to 5 channels)
Column dust & water ice	τ at 1064 nm = 0 to 5 \pm 10-20%	Radiance soundings at 12, 22, 32 μm
Water vapor column	Column abundance from 5 to 400 $\text{pr-}\mu\text{m}$ \pm 10-20%	Radiance sounding at 42 μm , wide and narrow-band measurement
Surface temperature	100-300 K, 0.5 K accuracy	Surface radiance at 32 μm

TRL story/development required

Current TRL	6
Heritage	MRO MCS
\$ to TRL 5	N/A
Time to TRL 5	N/A
\$ TRL 5 to 6	N/A
Time TRL 5 to 6	N/A
Notes:	Could be identical to polar orbiter (P) mini-MCS, optimized spectral channel selection is preferable. may need more sophisticated pointing system

Argus 1000/2000 NIR Spectrometer



Why measure surface pressure?

- Identify synoptic weather
- Tides
- Bonus: Measure CO₂ and H₂O ice on surface at high cadence

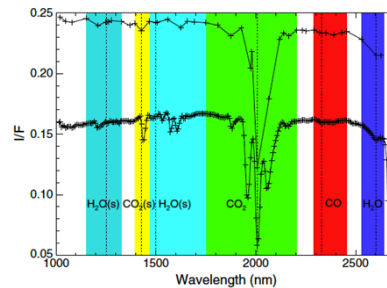

Toigo et al. (2013)

MOSAIC Objectives: I.B, I.C.a, II.B.

Resources/accommodations

Platform (order)	M, A, P	
# platforms	Threshold: 0	Baseline: 8
Mass	0.3 kg	
Power (incl heat)	< 2.5 W	2.5 W peak
Data Rate	Threshold: 1075 bps for A, 7873 bps for P and M	Baseline: ~30 kbps
FOV	0.15°	
Keep out zones	Keep out of direct Sun. Needs to operate under 40°C, will not survive >50°C	
ConOps	Can be turned off to operate in daylight, only as needed	

Measurement Requirements

Physical Parameter/ Observable Quantity	Surface Pressure/2000 nm reflected light
Range	100-1400 Pa
Precision	10 Pa
Horizontal Resolution	~40 km
Cadence	~1 hr, no full disk coverage, data only along lines of scan

*Note: bonus potential high resolution spectroscopy of ice cap
On-board processing to reduce data rates by retrieving surface pressure etc. possible*

TRL story/development required

Current TRL	6 (the non-extended version is 9)
Heritage	CanX-2
\$ to TRL 5	N/A
Time to TRL 5	N/A
\$ TRL 5 to 6	N/A
Time TRL 5 to 6	N/A
Notes:	Thoth Technology, Canada. Need version extended to 2200 nm. Need some way to slew it.

Chameleon Imager



Why weather context imagery?

- Track synoptic and mesoscale weather (incl. dust storms)
- Cloud-tracking to get winds
- Trapped gravity wave clouds

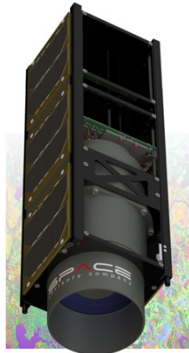

MOSAIC Objectives: I.A, I.B, I.C.1, II.B

Resources/accommodations

Platform (order)	A	
# platforms	Threshold: 3	Baseline: 4
Mass	1.6 kg	
Power (incl heat)	< 7 W imaging	< 5 W readout
Image File Size	~2 Gb uncompressed	
FOV	5.6° FOV; IFOV=0.012-0.024 mrad	
Keep out zones	Keep out of direct Sun. Needs to operate under 30°C, will not survive >70°C	
ConOps	Can operate in daylight only or when data downlink necessary	

Measurement Requirements

Physical Parameter/ Observable Quantity	Horizontal Resolution	Total Footprint
Weather context imagery in RGB-NIR (PAN+MS)	200-400 m	~1700 x 1700 km

TRL story/development required

Current TRL	6
Heritage	Gecko Imager: nSight-1
\$ to TRL 5	N/A
Time to TRL 5	N/A
\$ TRL 5 to 6	N/A
Time TRL 5 to 6	N/A
Notes:	SCS Space South Africa

Malin Space Science System infrared camera



Objectives:

- Characterize the structure and dynamics of the lower-middle atmosphere
 - Meso- to global scales
 - Diurnal and seasonal variability
- Characterize Martian weather for operational purposes

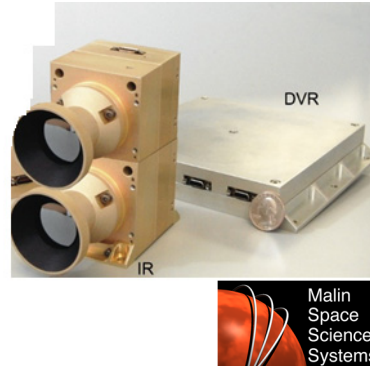

MOSAIC Objectives: I.B, I.C.a, II.B

Resources/accommodations

Platform (order)	A	
# platforms	Threshold: 3	Baseline: 4
Mass	1.4 kg each camera (of a set of two)	
Power (incl heat)	2 W idle (total of 2)	7 W peak (total of 2)
Data Rate	Threshold: 1.8 Mbit/s	Baseline: 7.2 Mbit/s
FOV	29° x 22°	
Keep out zones	No Sun in FOV	
ConOps	Always on	

Measurement Requirements

Physical Parameter	Range, accuracy, resolution	Observable Quantity
Atmospheric temperature	110-260 K, 1 K resolution, 0-40 km altitude, 10 km vertical resolution	Radiance around 15 micron
Surface temperature	130-320 K, 1 K resolution	Radiance at 7 micron
Dust column optical depth	0-2.5, 10-20% accuracy	Radiance at 9.3 micron
Water ice optical depth	0-0.5, 10-20% accuracy	Radiance at 11.8 micron

TRL story/development required

Current TRL	6
Heritage	ECAM-IR3A
\$ to TRL 5	N/A
Time to TRL 5	N/A
\$ TRL 5 to 6	N/A
Time TRL 5 to 6	N/A
Notes:	2 cameras are required for covering the full spectral range. Digital video recorder/data storage is needed.

● Malin Space Science System visible camera (ECAM-C50)



Objectives:

- Characterize dynamics of lower-middle atmosphere
 - Meso- to global scales
 - Diurnal and seasonal variability
- Characterize Martian weather for operational purposes



<http://www.msss.com/brochures/c50.pdf>

MOSAIC Objectives: I.B, I.C.a, II.B

Resources/accommodations

Platform (order)	A	
# platforms	Threshold: 3	Baseline: 4
Mass	500 g (margin not included)	
Power (incl heat)	1.75 W idle	2.5 W peak
Data Rate	Threshold: 7.4 Mbit/s	Baseline: 29.4 Mbit/s
FOV	29° x 22°	
Keep out zones.	No Sun in FOV	
ConOps	Always on	

Measurement Requirements

Physical Parameter	Range, accuracy, resolution	Observable Quantity
Extension of (dust/water ice) aerosol clouds	5 km to global, 5 km resolution	RGB values, only daytime
Duration of (dust/water ice) aerosol clouds	Fraction of the hour to tens of sols, 30 min resolution	RGB values, only daytime
U, V wind	0-200 m/s, 10 m/s accuracy	Cloud tracking from RGB values

TRL story/development required

Current TRL	9 (off-the-shelf camera)
Heritage	OSIRIX/REX and classified missions in Earth orbit
\$ to TRL 5	N/A
Time to TRL 5	N/A
\$ TRL 5 to 6	N/A
Time TRL 5 to 6	N/A
Notes:	This camera at the moment requires a digital video recorder/data storage

MSSS Visible camera + Thermal IR imager



- **One visible camera:** Off-the-shelf camera (ECAM-C50 from MSSS):

- Fixed-focus, narrow-angle lens
- 2592 x 1944 pixels
- 29° x 22° FOV (full disk and limb)
- 4 km resolution

- **Two thermal infrared camera** developed by MSSS:

- Fixed-focus, narrow-angle lens
- 640 x 480 pixels
- Same field of view as visible camera; 16 km resolution
- Filter wheel for selecting 6 spectral ranges
- Detectors responsive in the range 7.9-16 μm

- **Digital Video Recorder:** Off-the-shelf from MSSS (ECAM-DVR4)

- Buffer Size: 32 GB Non-Volatile / 128 MB Volatile

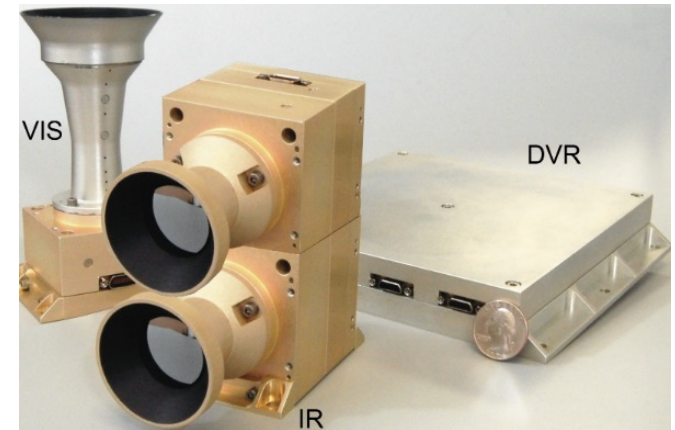

MSSS Visible camera + Thermal IR imager



Payload Component	Power (idle)	Power (imaging)
Thermal IR Cameras (Total)	2.0 W	7.0 W
1. Thermal IR Camera (each)	1.0 W	2.0 W
2. Filter Wheel	0.0 W (off)	3.0 W (operating)
VISIBLE Camera (ECAM-C50)	1.75 W	2.5 W
Digital Video Recorder(ECAM-DVR4)	9.75 W	13.5 W
TOTAL:	13.50 W	23.0 W

Table 5 Power requirements of payload components

Payload Component	Subsystem	TRL	Heritage
Visible Camera (ECAM-C50)	Electronics	9	Earth Orbiting missions, OSIRIS-REx
	Optics	6	Earth Orbiting missions, OSIRIS-REx
Infrared Camera (ECAM-IR3a)	Electronics	6	Earth Orbiting Missions
	Filter Wheel	6	Mars2020 Mastcam-Z
	Optics	6	Earth Orbiting Missions
Digital Video Recorder (ECAM-DVR4)	Electronics	9	Earth Orbiting missions, OSIRIS-REx

Table 6 TRL of payload components

Gecko Imager



Why weather context imagery?

- Track synoptic and mesoscale weather (incl. dust storms)
- Cloud-tracking to get winds
- Trapped gravity wave clouds



MOSAIC Objectives: I.A, I.B, I.C.1, II.B

Resources/accommodations

Platform (order)	A	
# platforms	Threshold: 3	Baseline: 4
Mass	0.39 kg	
Power (incl heat)	2.7 W imaging	1.4 W readout
Image File Size	3 MB uncompressed	450 kB compressed
FOV	9.2° FOV; IFOV=0.08 mrad	
Keep out zones	Keep out of direct Sun. Needs to operate under 30°C, will not survive >70°C	
ConOps	Must slew to get full disk	

Measurement Requirements

Physical Parameter/ Observable Quantity	Horizontal Resolution	Total Footprint
Weather context imagery in RGB (PAN + MS possible with higher res, higher mass/power)	1.3 km	~2700 x 2700 km

TRL story/development required

Current TRL	9
Heritage	nSight-1
\$ to TRL 5	N/A
Time to TRL 5	N/A
\$ TRL 5 to 6	N/A
Time TRL 5 to 6	N/A
Notes:	SCS Space South Africa

Thermal InfraRed imager (TIRI)



Objectives:

- Characterize structure and dynamics of lower-middle atmosphere
 - Meso- to global scales
 - Diurnal and seasonal variability
- Characterize Martian weather for operational purposes
- Characterize volatile cycling

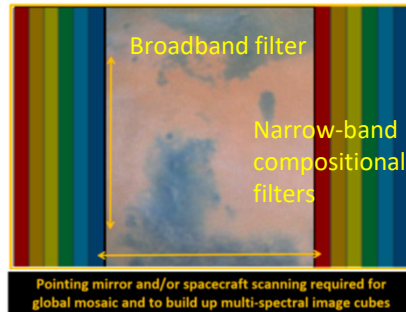

Image credit: NASA/ESA/HST

MOSAIC Objectives: I.A, I.B, I.C.a, II.B

Resources/accommodations

Platform (order)	A	
# platforms	Threshold: 3	Baseline: 4
Mass	4.6 kg (margin not included)	
Power (incl heat)	4.5 W avg	7.5 W peak
Data Rate	Threshold: <73.7 Mbit/s	Baseline: <295 Mbit/s
FOV	9° x 7° (requires 3 x 3 mosaicking for full disk picture)	
Keep out zones	No Sun in FOV	
ConOps	Always on	

Measurement Requirements

Physical Parameter	Range, accuracy, resolution	Observable Quantity
Temperature profile	110-260 K, 1 K accuracy, 0-40 km altitude, 10 km vert. res. (~1 scale height)	Radiance soundings around 15 μm
Column dust & water ice	τ at 1064 nm = 0 to 5 \pm 10-20%	Radiance soundings at 9, 12, 22 (possibly 32) μm
Water vapor column abundance	Column abundance from 5 pr- μm to 400 pr- μm \pm 10-20%	Possibly radiance sounding at 42 μm
Surface temperature	130-320 K, 1 K accuracy	Surface radiance at 7 μm (possibly 32 μm)

TRL story/development required

Current TRL	6
Heritage	MIRMIS/Comet Interceptor, LTM/Lunar Trailblazer
\$ to TRL 5	N/A
Time to TRL 5	N/A
\$ TRL 5 to 6	N/A
Time TRL 5 to 6	N/A
Notes:	Test programme in place to extend wavelength range from 6-25 microns to 100 microns

Thermal IR Imager (University of Oxford)



TIRI is the thermal-IR part of MIRMIS for ESA's Comet Interceptor. The optical concept is very similar to the Lunar Thermal Mapper for Lunar Trailblazer. University of Oxford/RAL Space.

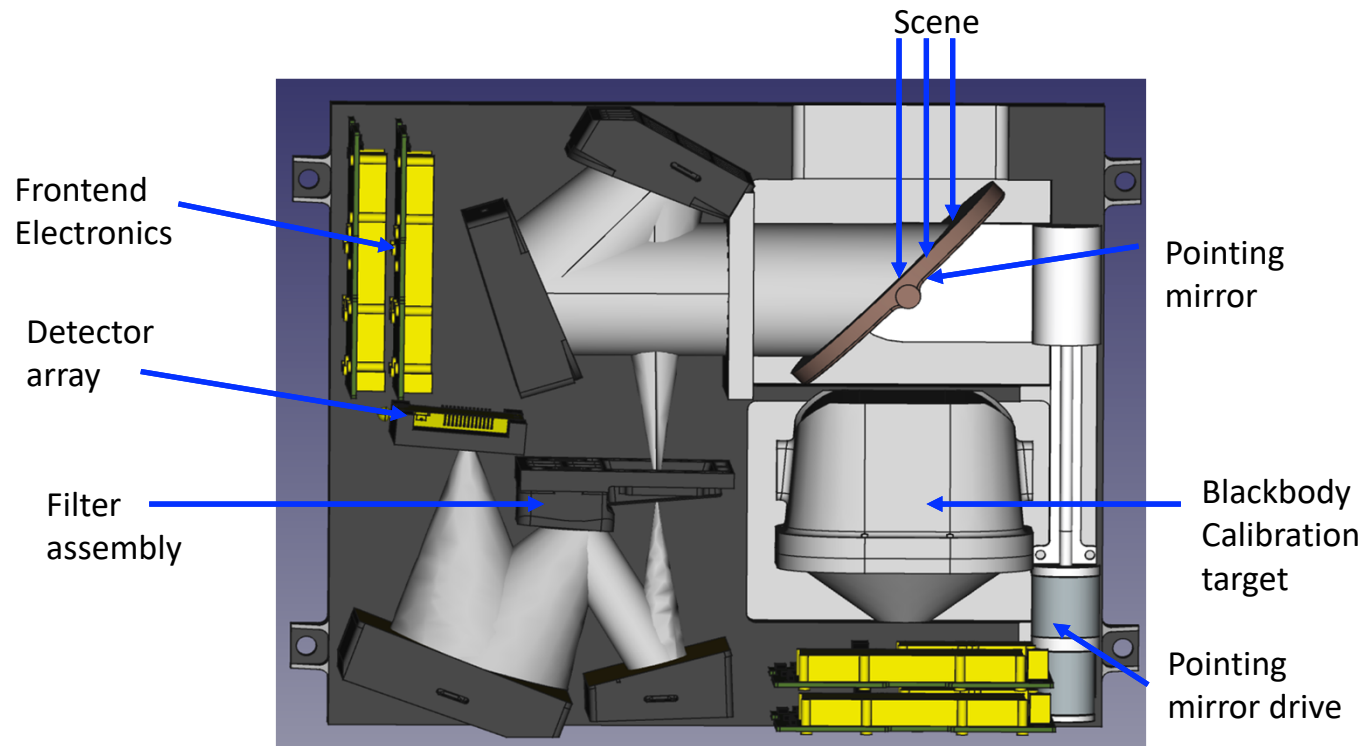

Size: 4U
Mass: 4.6 kg
Power: 4.5 W avg,
7.5 W peak

TRL: 6
ROM cost: ~\$8M

Thermal IR Imager (University of Oxford)



- **FoV:** 9° x 7°
- **IFoV:** 0.26 mrad
- **Baseline detector:** ULIS 640 x 480 microbolometer array with alternative options under consideration, 17 micron pixels
- **Optics:** 5 mirror system with diamond turned mirrors
- **Spectral range** = 6-25 microns with test programme in place to extent to 100 microns
- **Spectral channels** = multi-channel radiometer with up to 12 spectral channels, typical spectral channel width 0.3 microns but adjustable. Could include MCS channels or channels more optimized for nadir
- **Mass:** 4.6 kg (5.6 kg with margin)
- **Power:** 2.2 W standby, 4.5 W avg, 7.5 W peak
- **Volume:** 250 x 21 x 105 mm²
- **CDHU:** derived from the CMS instrument on UK TechDemoSat-1, supplied by RAL Space
- **Other:** 1 mechanism, pointing mirror for calibration, scene and space target views. Integrated blackbody calibration target

531 Mbits for the visible disk image without compression and assuming each channels is swept equally

Thermal IR Imager (University of Oxford)



Broadband filter

Narrow band compositional filters

Pointing mirror and/or spacecraft scanning required for global mosaic and to build up multi-spectral image cubes

Image credit:
NASA/ESA/HST

Wide Angle Imager (MARCI)



Why measure surface ice distribution?

- Determine changes in seasonal extent of surface ice over time, continuing monitoring record from MGS + MRO

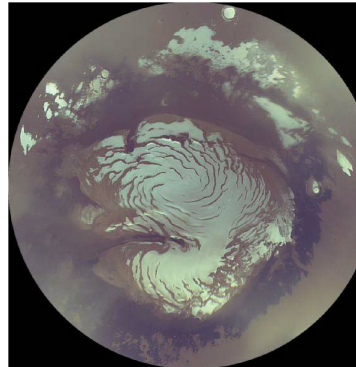

MOSAIC Objectives: IA, IIA

Resources/accommodations

Platform (order)	M only	
# platforms	Threshold: 1	Baseline: 1
Mass	481 g	
Power (incl heat)	7 W (when imaging)	<4 W (when idle)
Data Rate	Max: 6.2 Gbps/day for global full-res coverage	Min: 150 kbps for VIS or UV only
FOV	180°	
Keep out zones	N/A	
ConOps	Daily global daytime mapping (as downlink permits)	

Measurement Requirements

Physical Parameter/ Observable Quantity	Spatial Resolution	Spectral Range
VIS + UV Imaging	1-10 km	260-725 nm

TRL story/development required

Current TRL	9
Heritage	MARCI
\$ to TRL 5	N/A
Time to TRL 5	N/A
\$ TRL 5 to 6	N/A
Time TRL 5 to 6	N/A
Notes:	

Investigation 4: Thermosphere



- included in baseline payload
- not included in baseline payload

4

NIR, Visible Doppler Interferometer



Middle-Upper Atmosphere Winds

- Knowledge gap in dynamics – especially between homopause and near exobase
- Winds reveal global-scale dynamics, large-scale waves, provides inputs to models

MOSAIC Objectives: I.C, II.C

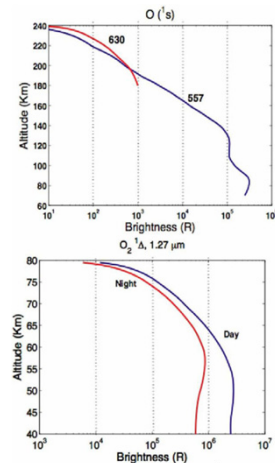

Resources/accommodations

Platform (order)	M	
# platforms	Threshold: 1	Baseline: 1
Mass	40 kg (for both channels)	
Power (incl. heat)	20 W avg (heat est.)	
Data Rate	Baseline: 14 kbps (number accounts for duty cycling of 2 images per 3 min)	
FOV	3°H x 5°V x 2 channels, 45° and 135° to Ram	
Limb Pointing (deg)	Control: 0.1, Know: 0.05, Jitter: 0.06 over 30s	
Keep out zones	No Sun in FOV while on. Baffle scatter below ~50km	
ConOps	Always on, two 30-s exposures ever 3 minutes	

Measurement Requirements

Physical Parameter/ Observable Quantity	Doppler shift of O(1S) (557.7 nm)	Doppler shift of O ₂ 1Δ (1.27 μm)
Altitude range	80-150 km ⁺	60-80 km
Altitude resolution	5 km ⁺⁺	2.5 km ⁺⁺
Precision - f(alt)	10-20 m/s	5-10 m/s
Cadence	3 minutes	3 minutes

⁺Daytime only

⁺⁺Must be 1/2 scale height or better

TRL story/development required

Current TRL	5 recent flight, 1 channel needs different wavelengths, vastly different radiation, thermal
Heritage	ICON MIGHTI
\$ to TRL 6	\$3 M
Time to TRL 6	9 months
Notes:	Thermal control, pointing stability, knowledge are drivers

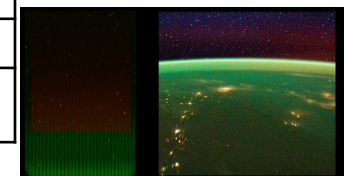

FUV/MUV Spectrograph



Thermospheric/Mesospheric Airglow

Vertical information:

- Composition
- Temperature
- Transport
- Energy deposition

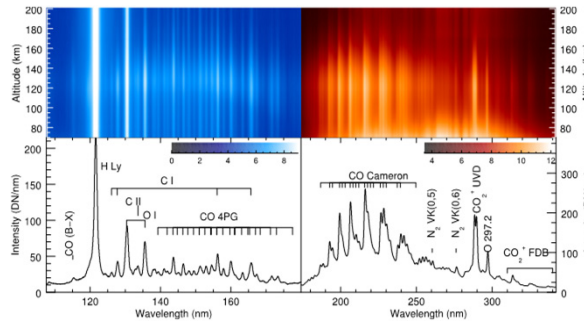

MOSAIC Objectives: I.C, II.C

Resources/accommodations

Platform (order)	M	
# platforms	Threshold: 1	Baseline: 1
Mass	27 kg	
Power (incl heat)	28 W avg	
Data Rate	Threshold: 5 kbps	Baseline: 8 kbps
FOV	<2° slit length, 5° vertical scan range	
Keep out zones.	Avoid Sun in FOV, scan mirror stow capability	
ConOps	Vertical limb scans	

Measurement Requirements

Physical Parameter/ Observable Quantity	FUV Channel	MUV Channel
Wavelength Range	134-165 nm	190-300 nm
Spectral Resolution	1.5 nm	2 nm
Brightness precision	10% relative	10% relative
Profile Cadence	3 minutes	3 minutes

TRL story/development required

Current TRL	9
Heritage	MAVEN/IUVS
\$ to TRL 5	N/A
Time to TRL 5	N/A
\$ TRL 5 to 6	N/A
Time TRL 5 to 6	N/A
Notes:	Improve baffling, remove echelle, revisit 1st order MUV

Investigation 5: Ionosphere



- included in baseline payload
- not included in baseline payload

5

ELP



Why measure ionospheric density?

- Ionosphere is the interface between Mars and space
- Effects of crustal fields
- Reservoir for escape
- What is the spatial structure of the ionosphere?
- How does space weather affect the ionosphere?

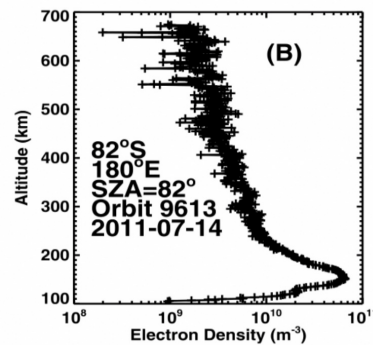

MOSAIC Objectives: I.C.2

Resources/accommodations

Platform (order)	Elliptical	
# platforms	Threshold: 2	Baseline: 2
Mass	0.5 kg (electronics + sensor) + TBD (harness + boom)	
Power (incl heat)	1.5 W avg	1.5 W peak
Data Rate	Threshold: ~20 bps (orbit avg)	Baseline: ~20 bps (orbit avg)
FOV	NA	
ConOps	Operational below 800 km altitude	
Other	Measurements within spacecraft plasma wake are unreliable	

Measurement Requirements

Physical Parameters	Ion and electron density, spacecraft potential
Density range	200-1E4 cm ⁻³
Density resolution	200 cm ⁻³
Altitude range	200-800 km
Altitude resolution	5 km
Cadence	20 measurements per sol for 1 Mars year, dispersed in MSO coordinates

TRL story/development required

Current TRL	6
Heritage	NASA ESCAPEDE, NSF DICE, WADIS I+II, MTeX, NASA LLITED
\$ to TRL 5	N/A
Time to TRL 5	N/A
\$ TRL 5 to 6	N/A
Time TRL 5 to 6	N/A
Notes:	

Radio Science Instrument (Radio transponder + SSPA + antennas)



Satellite-to-satellite radio occultations

- High vertical resolution sounding of the atmosphere from the surface to the ionosphere
- Dense coverage spatially and diurnally compared to Spacecraft-Earth occultations

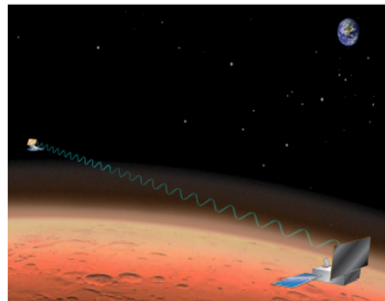

MOSAIC Objectives: I.B, I.C, II.B, II.C, II.D

Resources/accommodations

Platform (order)	P, M, E, A	
# platforms	Threshold: P (3), M (1), E (1)	Baseline: P (3), M (1), E (2)
Mass	3 kg (1.5 kg radio/Iris + 1.5 kg USO) [not incl. antennas]	
Power (incl heat)	15 W avg	35 W peak
Data Rate	Threshold: 10 kbps	Baseline: 20 kbps
FOV	$\pm 10^\circ$ in elevation, $\pm 60^\circ$ in azimuth, fore & aft	
Keep out zones	Clear FOV. Minimize EMI and multipath	
ConOps	On 5 minutes before and after an occultation event	

Measurement Requirements

Physical Parameter/ Observable Quantity	Temperature, pressure, geopotential height	Electron density in ionosphere
Altitude range	0-40 km	80-250 km
Precision	1 K, 2 Pa (near surface)	2×10^3 per cm^3
Vertical resolution	1 (2) km baseline (threshold)	1 (2) km baseline (threshold)
Number of observations	150 (75) profiles/day baseline (threshold)	150 (75) profiles/day baseline (threshold)
Sampling distribution	Global, all local times	Global, all local times
Operating frequencies	X or Ka	UHF or S

TRL story/development required

Current TRL	5
Heritage	MarCO (Iris)
\$ to TRL 5	N/A
Time to TRL 5	N/A
\$ TRL 5 to 6	\$3 M
Time TRL 5 to 6	3 years
Notes:	Iris \rightarrow UST-Lite; miniaturized USO under development

Investigation 6: Exosphere and Neutral Escape



- included in baseline payload
- not included in baseline payload

6

EUV/FUV Spectrograph



Why measure EUV/FUV emission?

- Infer H and O abundance and escape rate
- Correlate escape with lower/middle atmosphere and solar drivers

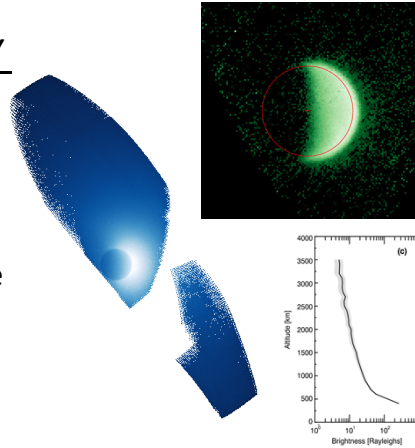

MOSAIC Objectives: I.C

Resources/accommodations

Platform (order)	A	
# platforms	Threshold: 1	Baseline: 1
Mass	21 kg	
Power (incl heat)	12 W avg	17 W peak
Data Rate	Threshold: 550 Mbit/week	Baseline: ~2 Gbit/week
FOV	0.7 x 11° slit	
ConOps	Requires spacecraft pointing for images and limb scans	

Measurement Requirements

Physical Parameter/ Observable Quantity	Hydrogen brightness	Oxygen Brightness
Wavelength	121.6 nm, 102.6 nm	130.4 nm
Brightness	SNR10 @250 R, SNR 3 @ 10 R	SNR 3 @ 0.1 R
Altitude Range	disk – 6+rM	disk – 6+rM
Cadence	10 minutes	10 minutes

TRL story/development required

Current TRL	9
Heritage	EMM/EMUS, GOLD
\$ to TRL 5	N/A
Time to TRL 5	N/A
\$ TRL 5 to 6	N/A
Time TRL 5 to 6	N/A
Notes:	

Investigations 7 (Magnetosphere and Ion Escape) and 8 (Space Weather)



- included in baseline payload
- not included in baseline payload

7,8

Ion Energy/Angle/Mass Spectrometer



Why measure ions?

- Planetary ion density, composition, flows
- Ion accel., loss, precipitation
- Ion velocity distribution functions and conics
- Deflection, slowing of solar wind

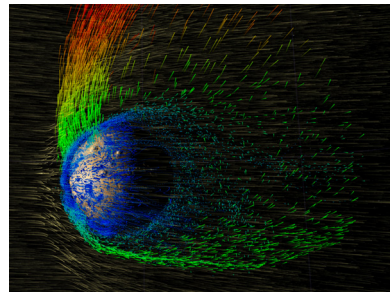

MOSAIC Objectives: I.C.a, I.D

Resources/accommodations

Platform (order)	Elliptical	
# platforms	Threshold: 2	Baseline: 2
Mass	~2 kg (half of THEMIS ESA + TOF section)	
Power	~3 W (half of THEMIS ESA + TOF section)	
Data Rate	Threshold: 1 kbps	Baseline: 2 kbps
FOV	180° x 6° (spacecraft spin sweeps 4π ster)	
Accommodation	Electrostatic cleanliness, magnetometer necessary	
ConOps	Always on	

Measurement Requirements

Parameter	Value
Energy Range	~1 eV to 20 keV
Energy Resolution	$\Delta E/E \sim 25\%$
Flux Range	$10^4 - 10^{10}$ eV/[cm ² sec ster eV]
Field of View	180° x 6° (s/c spin sweeps 4π)
Angular Resolution	22.5° x 11.25°
Cadence	16 sec

TRL / development required

Current TRL	6	
Heritage	ESA: THEMIS Plasma	TOF: MAVEN STATIC

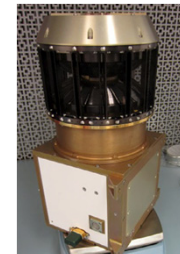
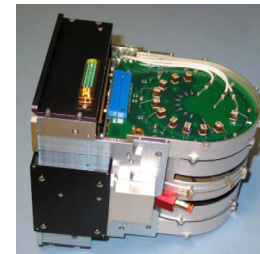

Ion Energy/Angle Spectrometer



Why measure ions?

- Solar wind and magnetosheath density, temperature, flow
- Charge exchange rate
- Plasma processes throughout Mars system

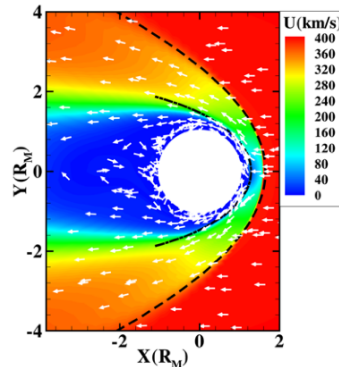

MOSAIC Objectives: I.C.a, I.D

Resources/accommodations

Platform (order)	Areostationary	
# platforms	Threshold: 2	Baseline: 2
Mass	2.6 kg	
Power	2.1 W	
Data Rate	Threshold: 0.5 kbps	Baseline: 1 kbps
FOV	360° x 80°	
Accommodation	Sun near center of FOV	
ConOps	Always on	

Measurement Requirements

Parameter	Value
Energy Range	50 eV to 10 keV
Energy Resolution	$\Delta E/E \sim 15\%$
Flux Range	$10^7 - 10^{10}$ eV/[cm ² sec ster eV]
Field of View	180° x 40°
Angular Resolution	30° (10° in Sun direction)
Cadence	16 sec

TRL / development required

Current TRL	9
Heritage	MAVEN SWIA

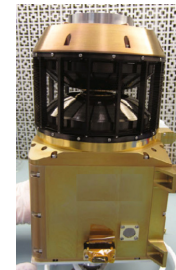

Electron Spectrometer (Areostationary)



Why measure electrons?

- Infer magnetic topology
- Infer magnetic reconnection
- Infer field-aligned and shock potentials
- Cause ionization, patchy night-side ionosphere, discrete aurora

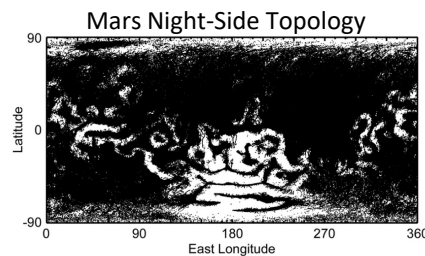

MOSAIC Objectives: I.C.b, I.D

Resources/accommodations

Platform (order)	Areostationary	
# platforms	Threshold: 0	Baseline: 2
Mass	1.8 kg	
Power	1.6 W	
Data Rate	Threshold: 0.5 kbps	Baseline: 1 kbps
FOV	360° x 120° (boom highly desirable)	
Accommodation	Electrostatic cleanliness, magnetometer necessary	
ConOps	Always on	

Measurement Requirements

Parameter	Value
Energy Range	1 eV to 10 keV
Energy Resolution	$\Delta E/E \sim 25\%$
Flux Range	$10^4 - 10^{10} \text{ eV}/[\text{cm}^2 \text{ sec ster eV}]$
Field of View	> 50% of sky
Angular Resolution	30°
Cadence	16 sec

TRL / development required

Current TRL	9
Heritage	MAVEN SWEA

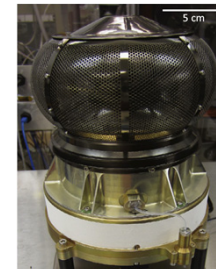

Electron Spectrometer (Elliptical)



Why measure electrons?

- Infer magnetic topology
- Infer magnetic reconnection
- Infer field-aligned and shock potentials
- Cause ionization, patchy night-side ionosphere, discrete aurora

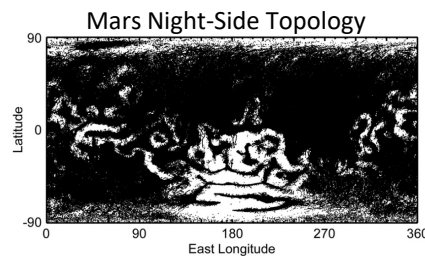

MOSAIC Objectives: I.C.a, I.D

Resources/accommodations

Platform (order)	Elliptical	
# platforms	Threshold: 2	Baseline: 2
Mass	~1.5 kg (half of THEMIS ESA)	
Power	~1 W (half of THEMIS ESA)	
Data Rate	Threshold: 0.5 kbps	Baseline: 1 kbps
FOV	360° x 6° (spacecraft spin sweeps 4π ster)	
Accommodation	Electrostatic cleanliness, magnetometer necessary	
ConOps	Always on	

Measurement Requirements

Parameter	Value
Energy Range	1 eV to 10 keV
Energy Resolution	$\Delta E/E \sim 25\%$
Flux Range	$10^4 - 10^{10}$ eV/[cm ² sec ster eV]
Field of View	> 50% of sky
Angular Resolution	30°
Cadence	16 sec

TRL / development required

Current TRL	9
Heritage	THEMIS ESA

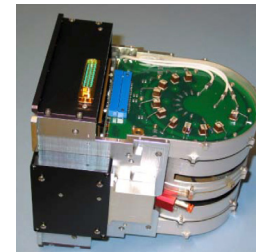

Energetic Particle Detector



Why measure SEPs?

- Cause atmospheric ionization and chemistry
- Spacecraft radiation hazard
- Astronaut radiation hazard
- Cause diffuse aurora

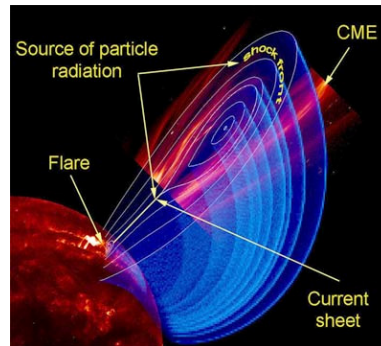

MOSAIC Objectives: I.C.a, I.D

Resources/accommodations

Platform (order)	Areostationary only	
# platforms	Threshold: 2	Baseline: 2
Mass	0.9 kg	
Power (incl heat)	5.5 W avg	22 W peak
Data Rate	Threshold: 20 bps	Baseline: 100 bps
FOV	30° x 40° x 2 ends, ideally centered 45° to the Sun line	
Keep out zones	No Sun in FOV for > 5 minutes	
ConOps	Always on (aperture doors for protection)	

Measurement Requirements

Physical Parameter/ Observable Quantity	Electron Flux	Ion Flux
Energy Range	20 keV to 1 MeV	20 keV to 10 MeV
Flux Range	10 - 10 ⁶ eV/[cm ² sec ster eV]	
Flux precision	30%	
Cadence	10 minutes	

TRL story/development required

Current TRL	9
Heritage	THEMIS SST, MAVEN SEP

Extreme Ultraviolet Monitor



Why measure EUV?

- Maintains dayside ionosphere, which sources nightside
- Drives thermospheric chemistry, atmospheric loss
- Observe solar activity at Mars
- Solar occultations

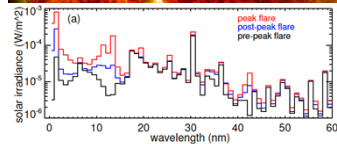
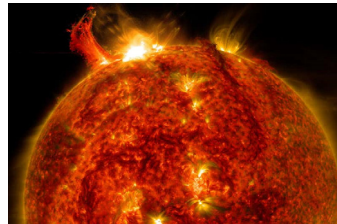

MOSAIC Objectives: I.C.a, I.D

Resources/accommodations

Platform (order)	Areostationary only	
# platforms	Threshold: 2	Baseline: 2
Mass	1.1 kg	
Power (incl heat)	0.73 W	
Data Rate	Threshold: 20 bps	Baseline: 200 bps
FOV	-3 to +3°, centered on Sun	
Accommodation	Sun pointed to within 3°	
ConOps	Always on	

Measurement Requirements

Parameter	Value
Spectra irradiance	10 ⁻⁶ to 3 x 10 ⁻² W/m ² /nm
Irradiance precision	15% (dl/l)
Wavelength range	3 band passes: 0.1-7, 17-22, 121-122 nm
Cadence	16 sec

TRL story/development required

Current TRL	4
Heritage	MAVEN EUVM
Time to TRL 5	3 months
\$ to TRL 5	\$60 K
Time to TRL 6	3 months
\$ to TRL 6	\$40 K

Fluxgate Magnetometer



Why measure magnetic field?

- Controls charged particle motion above exobase
- Plays central role in hybrid Mars-solar wind interaction
- Mechanism for storing and releasing energy into system

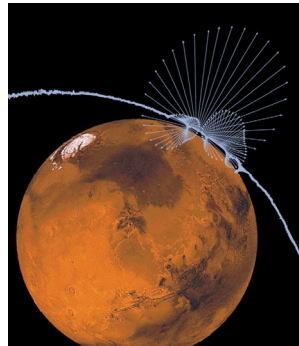

MOSAIC Objectives: I.C.a, I.D

Measurement Requirements

Parameter	Value
Field strength range	0.3 to 1000 nT
Field strength precision	0.3 nT or 10% (whichever is larger)
Cadence	1 sec

Resources/accommodations

Platform (order)	Elliptical, Areostationary	
# platforms	Threshold: 4	Baseline: 4
Mass	1.3 kg (incl. boom)	
Power (incl heat)	4.9 W avg (incl. heaters)	
Data Rate	Threshold: 200 bps	Baseline: 800 bps
FOV	Omnidirectional	
Accommodation	Magnetic cleanliness (static and dynamic)	
Accommodation	Boom with gradiometer configuration highly desired	
ConOps	Always on	

TRL story/development required

Current TRL	9
Heritage	MAVEN MAG, THEMIS MAG, many other missions

Search Coil Magnetometer



Why measure magnetic waves?

- Identify plasma wave modes in the Mars environment
- Probe reconnection and current sheet instabilities
- Investigate energy transport in the magnetosphere

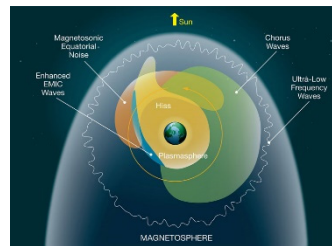

MOSAIC Objectives: I.C.a, I.D

Measurement Requirements

Parameter	Value
Dynamic range	10^{-4} to 1 nT/sqrt(Hz)
Frequency range	1 Hz to 4 kHz
Sensitivity	2 pT/sqrt(Hz) @ 10 Hz
Cadence	100 samp/s (burst mode, 1-5% orb avg duty cycle)

Resources/accommodations

Platform (order)	Elliptical only	
# platforms	Threshold: 0	Baseline: 2
Mass	1.8 kg	
Power (incl heat)	0.075 W (no heater required)	
Data Rate	Threshold: 200 bps	Baseline: 800 bps
FOV	Omnidirectional	
Accommodation	Magnetic cleanliness (dynamic)	
Accommodation	Boom highly desired	
ConOps	Always on	

TRL story/development required

Current TRL	9
Heritage	THEMIS SCM

Electric Fields



Why measure electric fields?

- Direct measure of **E**:
 - Flows and shears
 - Reconnection and shock fields
- Measure Poynting flux (**E x B**)
- Characterize wave modes:
 - Energization and scattering of e^-
 - Current sheet instabilities

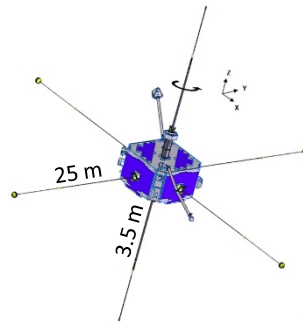

MOSAIC Objectives: I.C.a, I.D

Resources/accommodations

Platform (order)	Elliptical only	
# platforms	Threshold: 0	Baseline: 2
Mass	12 kg (4 wire booms, 2 stacer booms, bias + sig proc)	
Power	0.24 W	
Data Rate	Threshold: 0.5 kbps	Baseline: 1 kbps
FOV	Omnidirectional	
Accommodation	Electrostatic cleanliness, spinning spacecraft	
ConOps	Always on	

Measurement Requirements

Parameter	Value
Electric field	-300 to +300 mV/m (DC) -100 to +100 mV/m (AC)
Wave power	10^{-4} to 10^2 mV/m/sqrt(Hz)
Frequency range	DC to 300 kHz
Cadence	1/spin (~3 sec on THEMIS) (burst mode, 1-5% orb avg duty cycle)

TRL story/development required

Current TRL	9
Heritage	THEMIS EFI

D.2 MOSAIC Platform Summary

Tables D-1 to D-6 contain a payload platform summary, also shown in Section 3 FO 3-1.

Table D-1. MOSAIC Mothership Platform. Key: B = Science Baseline, T = Science Threshold, Cost = \$FY20, QC = Quad Chart.

Instrument	Investigation	Priority		Mass	Power	Cost	QC
P-band SAR + Sounder	1	T : 1	B : 1	90 kg	200 W	\$170 M	2
Wide Angle Imager (MAVRIC)	1	T : 1	B : 1	3.4 kg	10.3 W	\$5 M	3
Thermal IR radiometer (AMCS)	2	T : 1	B : 1	9 kg	18 W	\$25 M	5
Wind LIDAR (MARLI)	2	T : 1	B : 1	45 kg	91 W	\$40 M	6
Sub-mm sounder	2	T : 1	B : 1	35 kg	39 W	\$35 M	7,8
Near IR spectrometer (Argus)	3	T : 0	B : 1	0.3 kg	2.5 W	\$0.34 M	13
Wind doppler interferometer	4	T : 1	B : 1	40 kg	20 W	\$40 M	26
FUV/MUV spectrograph	4	T : 1	B : 1	27 kg	28 W	\$30 M	27
Radio occultation (USO)	3,5	T : 1	B : 1	1.5 kg	3 W	\$2 M	30
Total				251 kg	412 W	\$347 M	

Table D-2. MOSAIC Aro Carrier Platform. Key: B = Science Baseline, T = Science Threshold, Cost = \$FY20, QC = Quad Chart.

Instrument	Investigation	Priority		Mass	Power	Cost	QC
Visible camera (Chameleon)	3	T : 1	B : 1	1.6 kg	7 W	\$0.5 M	14
TIR radiometer (mini-MCS)	3	T : 1	B : 1	3.5 kg	8 W	\$10 M	12
NIR spectrometer (Argus)	3	T : 0	B : 1	0.3 kg	2.5 W	\$0.34 M	13
FUV/EUV spectrograph	6	T : 1	B : 1	21 kg	12 W	\$20 M	32
Fluxgate magnetometer	8	T : 1	B : 1	1.3 kg	4.9 W	\$4 M	40
Ion energy/angle	8	T : 1	B : 1	2.6 kg	2.1 W	\$3 M	35
Electron energy/angle	8	T : 0	B : 1	1.8 kg	1.6 W	\$3 M	36
Energetic ion/electron	8	T : 1	B : 1	0.9 kg	5.5 W	\$0.8 M	38
Extreme UV monitor	8	T : 1	B : 1	1.1 kg	0.7 W	\$2 M	39
Total				34.1 kg	44.3 W	\$45.8 M	

Table D-3. MOSAIC Aro SmallSat A Platform. Key: B = Science Baseline, T = Science Threshold, Cost = \$FY20, QC = Quad Chart.

Instrument	Investigation	Priority		Mass	Power	Cost	QC
Visible camera (Chameleon)	3	T : 1	B : 1	1.6 kg	7 W	\$0.5 M	14
TIR radiometer (mini-MCS)	3	T : 1	B : 1	3.5 kg	8 W	\$10 M	12
NIR spectrometer (Argus)	3	T : 0	B : 1	0.3 kg	2.5 W	\$0.34 M	13
Fluxgate magnetometer	8	T : 1	B : 1	1.3 kg	4.9 W	\$4 M	40
Ion energy/angle	8	T : 1	B : 1	2.6 kg	2.1 W	\$3 M	35
Electron energy/angle	8	T : 0	B : 1	1.8 kg	1.6 W	\$3 M	36
Energetic ion/electron	8	T : 1	B : 1	0.9 kg	5.5 W	\$3 M	38
Extreme UV monitor	8	T : 1	B : 1	1.1 kg	0.7 W	\$2 M	39
Total				13.1 kg	32.3 W	\$28.8 M	

Table D-4. MOSAIC Arco SmallSat B Platform. Key: B = Science Baseline, T = Science Threshold, Cost = \$FY20, QC = Quad Chart.

Instrument	Investigation	Priority		Mass	Power	Cost	QC
Visible camera (Chameleon)	3	T : 1	B : 2	1.6 kg	7 W	\$0.5 M	14
TIR radiometer (mini-MCS)	3	T : 1	B : 2	3.5 kg	8 W	\$10 M	12
NIR spectrometer (Argus)	3	T : 0	B : 2	0.3 kg	2.5 W	\$0.34 M	13
Total (per satellite)				5.4 kg	17.5 W	\$10.8 M	

Table D-5. MOSAIC Polar Platform. Key: B = Science Baseline, T = Science Threshold, Cost = \$FY20, QC = Quad Chart.

Instrument	Investigation	Priority		Mass	Power	Cost	QC
TIR radiometer (mini-MCS)	3	T : 1	B : 3	3.5 kg	8 W	\$10 M	11
NIR spectrometer (Argus)	3	T : 0	B : 3	0.3 kg	2.5 W	\$0.34 M	13
Radio occultation (USO)	3,5	T : 1	B : 3	3 kg	3 W	\$2 M	31
Total (per satellite)				6.8 kg	13.5 W	\$12.3 M	

Table D-6. MOSAIC Elliptical Platform. Key: B = Science Baseline, T = Science Threshold, Cost = \$FY20, QC = Quad Chart.

Instrument	Investigation	Priority		Mass	Power	Cost	QC
Fluxgate magnetometer	7	T : 2	B : 2	1.3 kg	4.9 W	\$4 M	40
Ion energy/angle/mass	7	T : 2	B : 2	3.3 kg	4.2 W	\$4 M	34
Electron energy/angle	7	T : 2	B : 2	1.8 kg	1.6 W	\$3 M	37
Electric fields	7	T : 0	B : 2	12 kg	0.24 W	\$2 M	42
Search coil magnetometer	7	T : 0	B : 2	1.8 kg	0.1 W	\$3 M	41
Langmuir probe	5	T : 2	B : 2	0.5 kg	1.5 W	\$1 M	29
Radio occultation (USO)	3,5	T : 2	B : 2	1.5 kg	3 W	\$2 M	30
Total (per satellite)				22.2 kg	15.5 W	\$19 M	

D.3 Spacecraft Technology

D.3.1 Delay Tolerant Network

A robust Delay Tolerant Network (DTN) between spacecraft and as part of direct-to-Earth communications is essential to support human exploration. Deep Space Optical Communications (DSOC) and DTN are synergistic and enhancing of all of MOSAIC's exploration- and science-related contributions.

DTN is a networking-layer software capable of “overlaying” existing communication links to provide semi-autonomous management of the communication between spacecraft or to Earth. It is intended to improve existing methods and communication architectures, not replace them. DTN implementations provide security, reliability, and high throughput over single or multi-hop communications architectures with reduced operational overhead. An overview of a Solar system internet works with DTN is shown in Figure D-1.

Delay Tolerant Networking has reached a high maturity (planned or operational on ISS, Gateway, EM-1, EO-1, DRTS, LADEE/LLCD, ECOSTRESS, and 38 other experiment packages, including a high TRL FPGA implementation for high-data-rate missions).

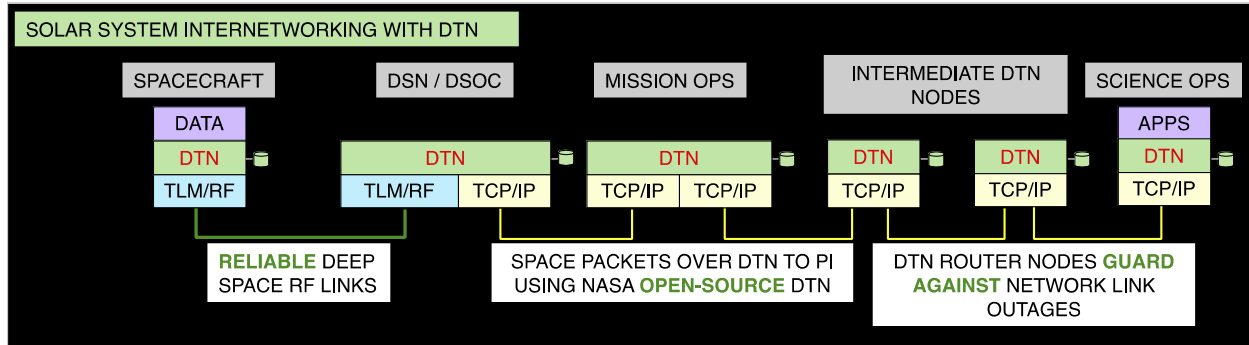

Figure D-1. Solar System Internet Working with DTN.

DTN’s “autonomous management” of relay and multi-hop communications can significantly reduce operational costs, especially for a mission architecture like MOSAIC that includes many nodes which are not intended to communicate direct to Earth as part of their primary science operation. DTN can allow easy use of any orbiter as a relay node, provided it has an existing communication link capability. That is, DTN seamlessly “overlays” existing communications networks or communications link technology, meaning it poses a minimal cost and tiny risk posture for addition to a mission architecture. Convergence layers, encryption modules, and robust software implementations in all popular programming languages are available. DTN link-to-link communications can be equipped with existing end-to-end encryption, error correction, automatic retransmission, or multipath (redundant channel) communication to enhance robustness and security. DTN integrates seamlessly with ground networks that use traditional internet architectures, again reducing integration costs for ground data systems, and providing an end-to-end solution.

DTN supports high speed communications with robust software and hardware-accelerated implementations, and can increase total throughput vs bent-pipe relays by leveraging “store and forward” and contact-graph-planned message relay architectures. Throughput is increased because data is automatically enqueued and forwarded when intermediate links become active, so a complete end-to-end link (e.g., from Mars surface to Earth) is not required, increasing the amount of time available for transmission at each link.

DTN is standards-based, with several open source implementations, tools, protocols, and convergence layers available. The NASA technology roadmap includes DTN, in particular JPL’s ION implementation as a key technology for deep space exploration and science activities, see Figure D-2.

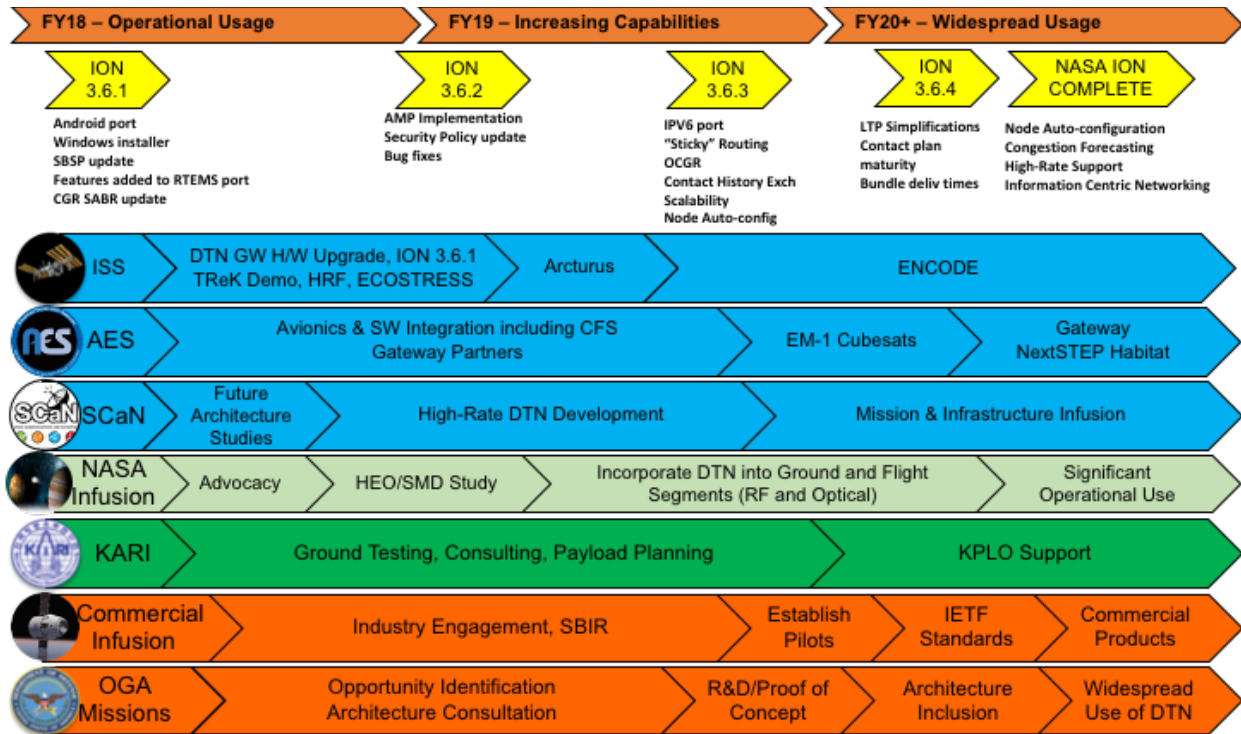

Figure D-2. NASA DTN technology roadmap.

D.3.2 Deep Space Optical Communication

A robust DTN between spacecraft and as part of direct-to-Earth communications is essential to support human exploration. Deep Space Optical Communications (DSOC) and DTN are synergistic and enhancing of all of MOSAIC’s exploration- and science-related contributions.

DSOC is an emerging NASA capability with the first technology demonstration planned in 2022-2023. The Psyche Mission spacecraft plans to host a Flight Laser Transceiver (FLT) developed by the DSOC Project at JPL. The Optical Communication Telescope Laboratory (OCTL) at JPL’s Table Mountain Facility will serve as the Ground Laser Transmitter (GLT) capable of transmitting a 5 kW average power beacon with low rate uplink data. The Hale telescope at Palomar Mountain will be rented to serve as the Ground Laser Receiver (GLR); it will be retrofitted with a photon counting receiver. The DSOC demonstration will cover spacecraft to Earth distances of 0.1-2.6 AU and include optical links prior to and immediately after a Mars flyby of the Psyche spacecraft at a range of 2 AU.

The demonstration objectives will be to validate link acquisition, tracking and pointing, and a high rate data return using an emerging CCSDS High Photon Efficiency (HPE) standard operating at approximately 1 bit per photon. Extending optical communications to an operational capability will require further development. For the flight transceiver, enhanced reliability, operational lifetime, and spacecraft accommodation will be required. On the ground, large aperture (5-10 m diameter) collectors that can operate day and night will be required.

Free space optical communication (FSOC) with unregulated optical bandwidths and increased power density in narrow laser beams supports 10-100 enhanced data rates from space-to-ground and for inter-satellite links. Modern lasers, photonics, and space optics will save size, weight and power with development. Additional functions like precision laser ranging, optometrics, quantum techniques, and light science are forthcoming. Weather and atmospheric constraints can be largely overcome with ground receiver site diversity and DTN techniques.

Technology infusion across international space agencies, defense and commercial service providers, for Lower Earth Orbit (LEO) to lunar distances, is advancing rapidly. The Lunar Laser Communication Demonstration (LLCD) from the LADEE spacecraft and the Optical Payload for Lasercomm Science (OPALS) from the ISS are recent NASA demonstrations. The Laser Communication Relay Demonstration (LCRD) and the Optical-to-Orion on ARTEMIS II are upcoming NASA programs. ESA and JAXA have advanced FSOC to operational use on both LEO-to-GEO and near-Earth-to-ground links. The SpaceX Starlink constellation is implementing FSOC for intersatellite links with several others to follow. The technological advances made through completed and upcoming near-Earth FSOC demonstrations readily lend themselves to the MOSAIC architecture for inter-spacecraft and/or Mars-surface-to-orbiter high-rate (100's of Mb/s to Gbit-class) optical links.

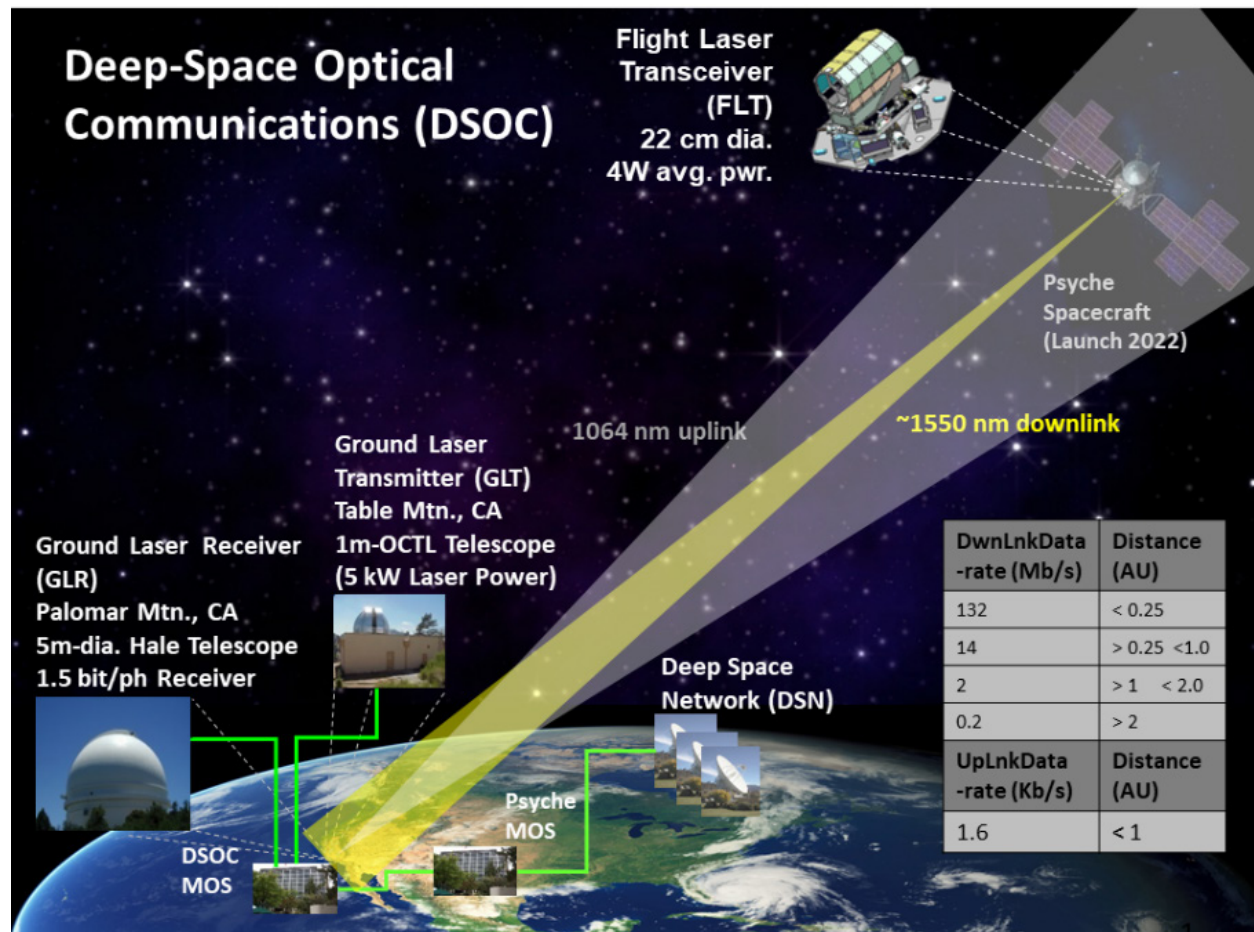

Figure D-3. Operational view of DSOC technology demonstration.

Higher photon efficiency technologies needed for longer haul deep space applications for Mars and beyond, are the next FSOC frontier. The DSOC Project is developing (i) a FLT; (ii) a GLT and (iii) a GLR shown in the operational view of Figure D-3. The uplink laser beacon assisted optical link acquisition with subsequent line-of-sight stabilization to enable downlink laser pointing will be a key demonstration objective. Downlink laser signaling using the emerging CCSDS HPE modulation and

coding scheme, for achieving approximately 1 bit per photon link performance, is another important objective of DSOC.

An optical operational capability for optical DTE from a low Mars orbiting spacecraft will require technology enhancement for both the flight and ground systems.

The DSOC FLT can transmit a maximum data-rate of 200 Mb/s from Mars at near range to an 8 m diameter collector on the ground. At Mars at its farthest range, 2-3 Mb/s is achievable. Reliability and extending lifetime will be a major thrust for operational deployment. Spacecraft accommodation and data interfaces needs attention since this will have mission planning impacts. Optionally, doubling the flight laser transmitter power and FLT aperture diameter can be targeted to improve Mars farthest range data-rates for human missions.

Foremost among ground system technology development is making large aperture diameter light collectors. While these do not require image quality, they need to be better than solar collectors for operating in the presence of atmospheric turbulence. Fortunately, in recognition of this critical need, NASA/Human Exploration and Operations Mission Directorate (HEOMD) is funding a hybrid RF-Optical Hybrid that will be capable of providing 8 m of aperture and operate in the day time as required for Mars missions. Adaptive optics techniques for reducing the atmospheric turbulence penalty on both downlink and uplink also need to be explored. Fast rise time, high power ground laser transmitters will enable both high precision ranging and high rate uplink. This is a compelling future technology area into which inroads have been made. Additionally, increasing the size of photon-counting detector arrays with corresponding high-speed signal processing development, already underway, will need to be ruggedized for operational use.

NASA’s 2020 Technology Taxonomy serves as a technology roadmap with which JPL is involved as indicated in Table D-7.

Table D-7. DSOC technology roadmap.

TYX05.1 Optical Comm	5.11 Detector Development	5.12 Large Aperture	5.1.3 Laser	5.1.4 Positioning Acquisition and Tracking (PAT)	5.1.5 Atmospheric Mitigation	5.1.6 Optimetrics	5.1.7 Innovative Signal Modulation
	JPL in partnership with NIST, LL-MIT and industry has pioneered photon counting detector	JPL is studying deployment of 8 m equivalent diameter apertures on Goldstone DSN antennae by 2025	Development of DSOC flight and ground lasers will be following with power scaling and reliability	JPL is preparing to demonstrate deep space PAT on DSOC technology demo	NASA’s LCRD Program has developed Adaptive Optics systems to be tested in the next few years, one implementation is at JPL’s OCTL telescope	JPL is doing signal processing development on the O2O AREMIS II	The CCSDS HPE standard to be instantiated on DSOC was originated at JPL in the early 2000’s

D.4 Instrument Technology

D.4.1 Polar-SAR and Sounder Hybrid Instrument

The Polar-SAR and Sounder Hybrid Instrument is based on prior JPL radar studies with additional electronics that enable the dual-frequency sounder mode. The block diagram for the hybrid instrument encompassing the Polar-SAR and the Sounder is shown in Figure D-4.

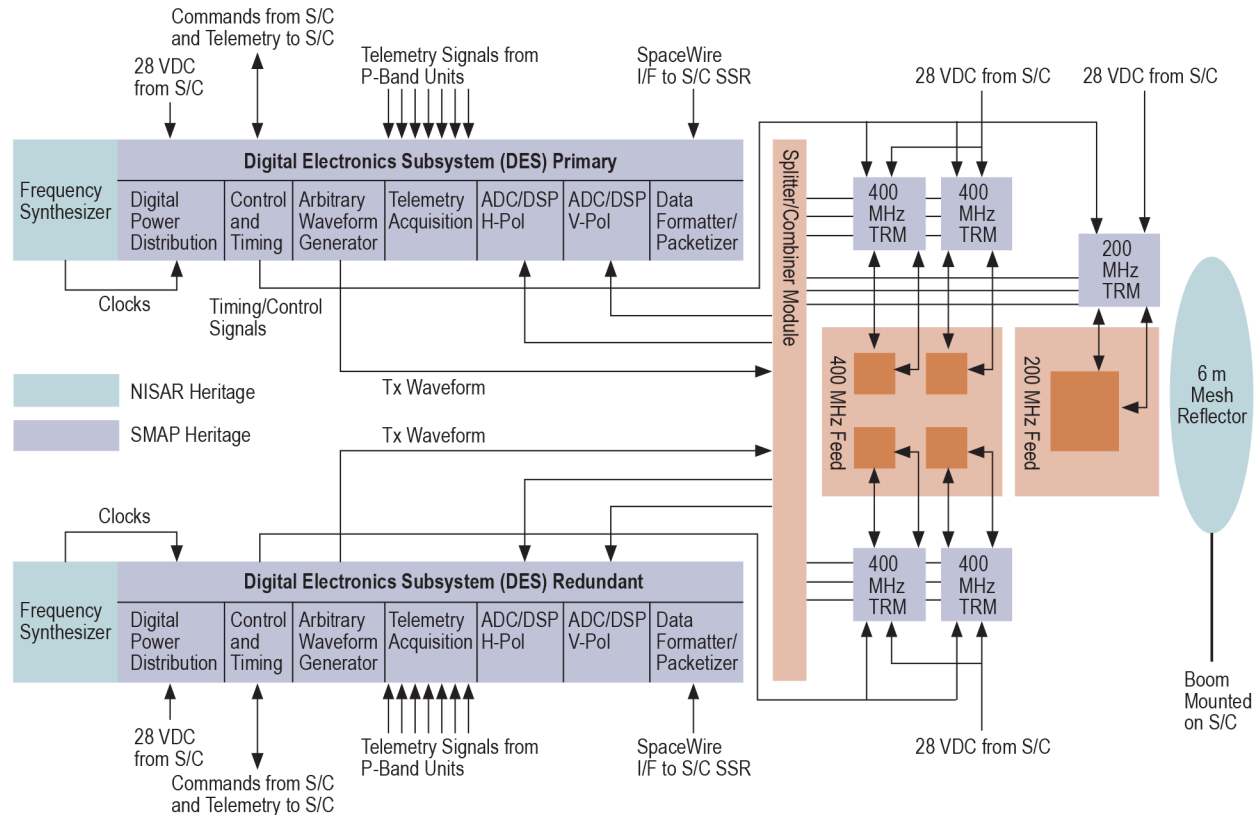

Figure D-4. MOSAIC block diagram for hybrid SAR and sounder.

Polar-SAR and Sounder Onboard Compression

To reduce the data rate due to the radar payload, the combined Polar-SAR and Sounder instrument will include an onboard processor (OBP) for the radar data. Range compression, azimuth compression, and multi-look processing will be completed onboard and only the processed radar images and radargrams will be downlinked to Earth in the nominal case. For performance analysis, calibration, and detailed science investigations, the option to send full data products will remain open. The OBP is similar to the OBP proposed on VERITAS (Freeman et al. 2016), and the compression algorithms have already successfully been employed on other radar missions (UAVSAR, SMAP, SWOT, etc.).

All onboard processing will employ the standard radar imaging algorithms. The azimuth and range compression describe SAR image formation. Range compression is a correlation of the transmitted signal with the returned signal to increase signal-to-noise and range resolution. Azimuth compression, or synthetic aperture processing, coherently sums all returns from a given point within the scene over the target illumination time (which is determined by the radar beam width). The result of azimuth and range compression is a two-dimensional radar image of the planetary surface. Multi-look processing then combines the returns of multiple resolution cells into one pixel, trading resolution for improved signal-to-noise ratio and reduced data rates.

An additional feature of the OBP (derived from VERITAS) is that the processing parameters may be changed during the mission. If inflight validation finds that an updated set of processing parameters would improve SAR data quality, they may be uploaded to the OBP.

There are two main data products for the Polar-SAR: high data rate (HDR, 30 m/pixel) and low data rate (LDR, 100 m/pixel) modes. The LDR mode is the nominal mode, and the HDR mode will be

used in “postage-stamp” fashion over features of interest. Tables D-8 and D-9 provide information on the downlinked processed image data rate for Polar-SAR for the two main data products. Table D-10 provides information on the data rate for the Sounder.

Table D-8. MOSAIC Processed Image Data Rate for the Polar-SAR instrument at 30 m/pixel.

Processed Image Data Rate for SAR, 30 m/pixel	
Downlinked Ground Projected Cross-Track Pixel Size (m)	30
Downlinked Azimuth Pixel Size (m)	30
Number of Range Looks	2
Number of Azimuth Looks	8
Total Number of Looks	19
Bits per Complex Sample	16
Strip Length for 1 Second (m)	3093
Number of Image Pixels Per Second	85918
Downlinked Processed Image Data Rate (Dual pol, Mbs)	1.37
Downlinked Processed Image Data Rate (Quad pol, Mbs)	2.75

Table D-9. MOSAIC Processed Image Data Rate for the Polar-SAR instrument at 100 m/pixel.

Processed Image Data Rate for SAR, 100 m/pixel	
Downlinked Ground Projected Cross-Track Pixel Size (m)	100
Downlinked Azimuth Pixel Size (m)	100
Number of Range Looks	8
Number of Azimuth Looks	38
Total Number of Looks	213
Bits per Complex Sample	16
Strip Length for 1 Second (m)	3093
Number of Image Pixels Per Second	7733
Downlinked Processed Image Data Rate (Dual pol, Mbs)	0.12
Downlinked Processed Image Data Rate (Quad pol, Mbs)	0.25

Table D-10. MOSAIC Processed Image Data Rate for the Sounder instrument.

Processed Image Data Rate for Sounder	
Expected along-track resolution: Fresnel zone radius [meters]	362
Number of integration time [seconds]	0.1
Number of pulses to average (PRF = 2800 Hz)	150
Number of additional bits to carry [bits]	2
Data bits in I/Q domain	10
Number of complex FFT data points	4096
Number of bits for each look [kbits per frame per look]	81.92
Number of looks	3
Frame update rate	9
Data rate (per second) [Mbps]	2.3

D.5 Additional Cost Model Techniques Information

JPL's business organization assessed the MOSAIC pre-decadal study using several techniques to ensure completeness:

1. Historical wrap factors for level-of-effort activities such as science, mission operations system, and ground data system that are level of effort, based on previous Mars missions (MRO, MER, Phoenix, MSL, Insight).
2. SEER-H and TruePlanning for the spacecraft system.
3. SSCM model for SmallSats constellation includes Areo Mothership, Areo Smallsat, Polar and Elliptical platforms. For each additional unit, the estimate account only for RE cost (40% of 1st unit value).
4. The Space Operations Cost Model (SOCM) for Phases E-F mission operations and data analysis costs.
5. LV Services estimate based on NASA guidance stated on document "GROUND RULES FOR MISSION CONCEPT STUDIES IN SUPPORT OF PLANETARY DECADAL SURVEY" released Nov. 2019. Assumed as a Launch Services Option 4 with high performance range valued at \$240M in FY20 which equal to \$274.6M in FY25.

MOSAIC Instruments are included in the assessment as pass-through from TeamX's NICM results. Phase A costs were added to the cost model estimates. As a gauge for the amount to apply, the previous New Frontiers 4 AO from 2016 was used as the basis. New Frontiers had a value of \$4M RY for Phase A with a start date in FY2018. Taking this same value of \$4M and inflating it to FY2025 dollars using the NASA New Start Inflation Index, the cost rounds up to \$5M.

Phase B-D validations were performed by first estimating the spacecraft system, then combining it with independent payload estimates and historical wrap factors.

Phase E-F are validated using SOCM (in combination with SEER and TruePlanning models).

The cost results from these parametric estimates are summarized in Table D-11, D-12, D-13, and D-14 for four different combinations:

- MOSAIC Mothership
- MOSAIC Mini-Mothership
- MOSAIC Baseline Constellation
- MOSAIC Descope 1 Constellation

Table D-11. Cost model results for MOSAIC Mothership (FY25 \$M). Highlighted cells represent **Wrap** and **SOCM**.

MOSAIC Mothership WBS	Team X	Method 1 (SEER-H)	Method 2 (True-Planning)	Delta Team X vs. Method 1 (%)	Delta Team X vs. Method 2 (%)
Phase A	1,805.7	5.0	5.0		
Phase B–D		1,833.2	1,935.8		
01.0 Project Management	41.5	217.3	193.2	-12%	-1%
02.0 PSE/MD	83.8				
03.0 Mission Assurance	66.3				
04.0 Science	68.4	40.49	43.15	69%	59%
05.0 Payload System	489.1	550.8	525.0	-11%	-7%
06.0 Flight System	665.6	533.4	712.0	25%	-7%
07.0 Mission Operations Preparation	36.4	114.61	122.15	-34%	-38%
09.0 Ground Data Systems	39.5	Incl. in MOS	Incl. in MOS		
08 LV Services	274.6	274.6	274.6		
10.0 ATLO	40.5	102.1	65.8	-60%	-38%
Phases A/D subtotal	1,805.7	1,838.2	1,940.8	-2%	-7%
01.0 Project Management	11.7	14.5	14.5		
02.0 Project Systems Engineering	0.2	Incl. in PM	Incl. in PM		
03.0 Mission Assurance	4.1	Incl. in PM	Incl. in PM		
04.0 Science	114.5	23.2	23.2		
07.0 Mission Operations	95.4	78.2	78.2		
09.0 Ground Data Systems	22.7	57.1	57.1		
Phases E–F subtotal	248.6	173.0	173.0	44%	44%
Total Cost (w/o reserves)	2,054.3	2,011.3	2,113.8	2%	-3%
Phases A/D excl. LV @ 50% reserves	765.6	781.8	833.1	-2%	-8%
Phases E/F @ 25% reserves	62.1	43.3	43.3	44%	44%
Total Cost + Reserves (A/D: 50%, E/F: 25%)	2,882.0	2,836.4	2,990.2	2%	-4%
Phases A/D excl. LV @ 30% reserves	459.3	469.1	499.9	-2%	-8%
Phases E/F @ 15% reserves	37.3	26.0	26.0	44%	44%
Total Cost + Reserves (A/D: 30%, E/F: 15%)	2,550.9	2,506.3	2,639.7	2%	-3%

Table D-12. Cost model results for MOSAIC Mini-Mothership (FY25 \$M). Highlighted cells represent Wrap and SOCM.

MOSAIC Mini-Mothership WBS	Team X	Method 1 (SEER-H/ SSCM)	Method 2 (True-Planning/ SSCM)	Delta Team X vs. Method 1 (%)	Delta Team X vs. Method 2 (%)
Phase A	1,067.6	5.0	5.0		
Phase B-D		1,078.2	1,148.2		
01.0 Project Management	21.0				
02.0 PSE/MD	46.2	116.7	77.9	-14%	28%
03.0 Mission Assurance	32.7				
04.0 Science	21.0	20.88	22.69	1%	-7%
05.0 Payload System	121.1	134.2	127.9	-10%	-5%
06.0 Flight System	470.4	420.7	551.5	12%	-15%
07.0 Mission Operations Preparation	28.1	59.09	64.24	-12%	-19%
09.0 Ground Data Systems	23.6	incl. in MOS	incl. in MOS		
08 LV Services	274.6	274.6	274.6		
10.0 ATLO	28.9	52.1	29.4	-45%	-2%
Phases A/D subtotal	1,067.6	1,083.2	1,153.2	-1%	-7%
01.0 Project Management	7.3	11.4	11.4		
02.0 Project Systems Engineering	0.2	Incl. in PM	Incl. in PM		
03.0 Mission Assurance	4.1	Incl. in PM	Incl. in PM		
04.0 Science	52.7	18.2	18.2		
07.0 Mission Operations	94.7	61.4	61.4		
09.0 Ground Data Systems	15.4	44.9	44.9		
Phases E-F subtotal	174.4	135.9	135.9	28%	28%
Total Cost (w/o reserves)	1,241.9	1,219.1	1,289.1	2%	-4%
Phases A/D excl. LV @ 50% reserves	396.5	404.3	439.3	-2%	-10%
Phases E/F @ 25% reserves	43.6	34.0	4.0	28%	28%
Total Cost + Reserves (A/D: 50%, E/F: 25%)	1,682.0	1,657.4	1,762.4	1%	-5%
Phases A/D excl. LV @ 30% reserves	237.9	242.6	263.6	-2%	-10%
Phases E/F @ 15% reserves	26.2	20.4	20.4	28%	28%
Total Cost + Reserves (A/D: 30%, E/F: 15%)	1,506.0	1,482.1	1,573.1	2%	-4%

Table D-13. Cost model results for MOSAIC Baseline Constellation (FY25 \$M). Highlighted cells represent **Wrap**, **SSCM**, and **SOCM**.

MOSAIC Baseline Constellation WBS	Team X	Method 1 (SEER-H/ SSCM)	Method 2 (True-Planning/ SSCM/)	Delta Team X vs. Method 1 (%)	Delta Team X vs. Method 2 (%)
Phase A	2,590.1	5.0	5.0		
Phase B–D		2,479.2	2,804.1		
01.0 Project Management	41.5			13%	28%
02.0 PSE/MD	191.7	293.7	259.5		
03.0 Mission Assurance	99.1				
04.0 Science	80.7	57.27	65.71	41%	23%
05.0 Payload System	686.8	684.0	643.1	0%	7%
06.0 Flight System	981.4	866.5	1,238.8	13%	-21%
6.01 Flight System Management	22.3	60.2	246.4		
6.02 Flight System System Engineering	73.7	Incl. in FS Mgmt	Incl. in FS Mgmt		
Mothership Bus	586.8	445.7	515.2	32%	14%
Polar Bus	57.9	47.0	47.0	23%	23%
Elliptical Bus	53.0	85.1	85.1	-38%	-38%
Areo Mothership Bus	121.2	121.3	121.3	0%	0%
Areo Smallsats Bus	51.5	49.4	49.4	4%	4%
6.14 Spacecraft I&T	15.0	58.0	174.5	-74%	-91%
07.0 Mission Operations Preparation	77.1	162.10	186.00	-2%	-15%
09.0 Ground Data Systems	81.8	Incl. in MOS	Incl. in MOS		
08 LV Services	274.6	274.6	274.6		
10.0 ATLO	75.4	141.0	136.4	-47%	-45%
Phases A/D subtotal	2,590.1	2,484.2	2,809.1	4%	-8%
01.0 Project Management	11.7	27.5	27.5		
02.0 Project Systems Engineering	0.2	Incl. in PM	Incl. in PM		
03.0 Mission Assurance	-	Incl. in PM	Incl. in PM		
04.0 Science	119.7	22.1	22.1		
07.0 Mission Operations	193.1	195.8	195.8		
09.0 Ground Data Systems	52.8	81.9	81.9		
Phases E–F subtotal	377.5	327.5	327.5	15%	15%
Total Cost (w/o reserves)	2,967.6	2,811.6	3,136.6	6%	-5%
Phases A/D excl. LV @ 50% reserves	1,157.8	1,104.8	1,267.3	5%	-9%
Phases E/F @ 25% reserves	94.4	81.9	81.9	15%	15%
Total Cost + Reserves (A/D: 50%, E/F: 25%)	4,219.7	3,998.3	4,485.7	6%	-6%
Phases A/D excl. LV @ 30% reserves	694.7	662.9	760.4	5%	-9%
Phases E/F @ 15% reserves	56.6	49.1	49.1	15%	15%
Total Cost + Reserves (A/D: 30%, E/F: 15%)	3,718.8	3,523.6	3,946.1	6%	-6%

Table D-14. Cost model results for MOSAIC Descope 1 Constellation (FY25 \$M). Highlighted cells represent **Wrap**, **SSCM**, and **SOCM**.

MOSAIC Descope 1 Constellation WBS	Team X	Method 1 (SEER-H/ SSCM)	Method 2 (True-Planning/ SSCM/)	Delta Team X vs. Method 1 (%)	Delta Team X vs. Method 2 (%)
Phase A		5.0	5.0		
Phase B–D	1,866.8	1,759.4	1,981.7		
01.0 Project Management	30.4			29%	61%
02.0 PSE/MD	160.0	197.6	159.0		
03.0 Mission Assurance	65.0				
04.0 Science	33.3	38.57	44.34	-14%	-25%
05.0 Payload System	294.1	267.3	246.0	10%	20%
06.0 Flight System	789.8	779.4	1,025.3	1%	-23%
6.01 Flight System Management	20.1	53.0	163.3		
6.02 Flight System Engineering	55.6	Incl. in FS Mgmt	Incl. in FS Mgmt		
Mothership Bus	419.6	372.3	444.0	13%	-6%
Polar Bus	57.9	47.0	47.0	23%	23%
Elliptical Bus	53.0	85.1	85.1	-38%	-38%
Areo Mothership Bus	121.2	121.3	121.3	0%	0%
Areo Smallsats Bus	51.5	49.4	49.4	4%	4%
6.14 Spacecraft I&T	11.0	51.2	115.2	-79%	-90%
07.0 Mission Operations Preparation	72.4	109.18	125.53	35%	17%
09.0 Ground Data Systems	75.0	Incl. in MOS	Incl. in MOS		
08 LV Services	274.6	274.6	274.6		
10.0 ATLO	72.2	92.8	107.0	-22%	-33%
Phases A/D subtotal	1,866.8	1,764.4	1,986.7	6%	-6%
01.0 Project Management	11.7	24.5	24.5		
02.0 Project Systems Engineering	0.2	Incl. in PM	Incl. in PM		
03.0 Mission Assurance	-	Incl. in PM	Incl. in PM		
04.0 Science	58.0	19.6	19.6		
07.0 Mission Operations	208.3	173.4	173.4		
09.0 Ground Data Systems	49.9	72.6	72.6		
Phases E–F subtotal	328.0	290.1	290.1	13%	13%
Total Cost (w/o reserves)	2,194.9	2,054.5	2,276.8	7%	-4%
Phases A/D excl. LV @ 50% reserves	796.1	744.9	856.1	7%	-7%
Phases E/F @ 25% reserves	82.0	72.5	72.5	13%	13%
Total Cost + Reserves (A/D: 50%, E/F: 25%)	3,073.0	2,872.0	3,205.4	7%	-4%
Phases A/D excl. LV @ 30% reserves	477.7	447.0	513.7	7%	-7%
Phases E/F @ 15% reserves	49.2	43.5	43.5	13%	13%
Total Cost + Reserves (A/D: 30%, E/F: 15%)	2,721.8	2,545.0	2,834.0	7%	-4%

In addition to parametric model validations, a top-level crosscheck of spacecraft/System I&T (WBS 06&10) is shown in Figure D-5, comparing mass vs. cost (\$/kg). The two MOSAIC combinations are shown to be below the trendline of both set of comparable missions: Mars missions only (MRO, Maven, MSL, InSight, and Phoenix) and the selected planetary historical missions.

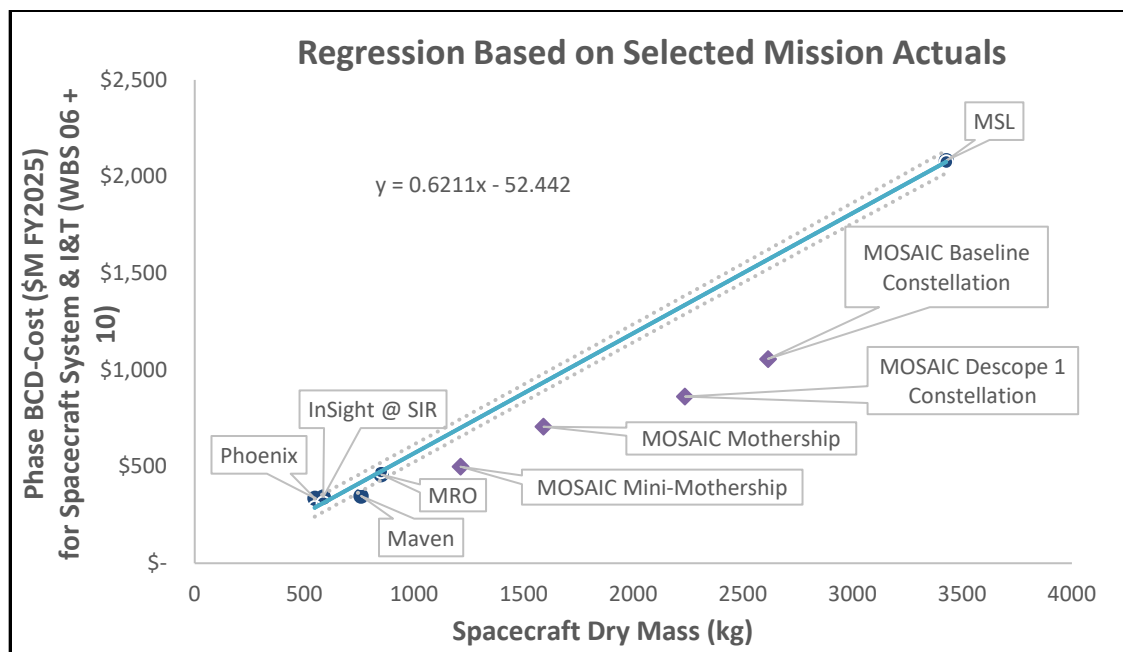

Figure D-5. Mars Missions vs MOSAIC \$/kg.

D.5.1 Wrap Factors

Wrap factors were developed from historical costs of selected JPL missions. Historical cost data comes from the NASA Cost Analysis Data Requirement (CADRe) for Launch or End of Mission. Wrap factors for WBS 04, 07, and 09 are computed as a percentage of total Phase B/C/D cost without LV or Reserves. Table D-15 shows the calculated historical wrap factor for each WBS that was applied to the SEER and TruePlanning models which do not estimate these costs.

Table D-15. Historical wrap factors for WBS 04, 07 and 09

	Juno	MER	InSight	Averages
WBS 04 Science	3.3%	2.1%	2.4%	2.6%
WBS 07 MOS	3.3%	3.2%	4.7%	3.7%
WBS 09 GDS	2.2%	3.4%	3.4%	3.0%

D.5.2 SEER-H

SEER-H (version 7.4.13) is a component level cost tool that is recognized for its built-in Knowledge Bases (KBases) that pre-populate most inputs with appropriate industry values and optional calibration adjustments. SEER’s built-in capabilities along with recommendations in the SEER-H Space Guidance v.3.1 were used to estimate the separate electrical and mechanical costs of each subsystem/assembly. SEER-H Space Guidance recommends that Class A should set certification level

to (Hi+/Hi+/VHi-), Class A/B to (Hi, Hi+, Hi+), and Class B to (Hi, Hi, Hi+) for mechanical/electronic components. The guidance also recommends the design complexity should set at (Hi-, Hi, Hi+) for Power and Propulsion subsystems. See Table D-16 for details.

Table D-16. MOSAIC SEER-H Setting and Model Inputs for Mothership and Mini-Mothership Spacecrafts.

Work Element Name	Application	Acquisition Category	Prototype Qty	Production Qty Yr 1	Mothership		Mini-Mothership	
					# Circuit Boards	Weight	# Circuit Boards	Weight
GN&C								
Sun Sensors	Sun Sensor - Space	Modification - Average	0.65	8	0	0.14	0	0.14
Star Trackers	Star Tracker - Standard, Space	Modification - Average	0.65	2	0	4.73	0	4.73
IMUs	Inertial Measurement Unit - Space	Modification - Average	0.65	2	0	4.4	0	4.4
RWAs	Reaction Wheel - Space	Modification - Average	0.65	4	0	9.9	0	9.9
Gimbal Drive Electronics	Controller - Electro-Mechanical Control	Modification - Average	0.65	1	2	0	2	0
Command & Data								
Processor: Main box	Processor - Central Processing Unit	Modification - Average	3.25	1	2	0	2	0
Memory: NVMCAM	Memory	Modification - Average	5.85	1	2	0	2	0
Telecom_I_F: MTIF	!~Communication s General	Modification - Average	3.25	2	4	0	4	0
General_I_F: MSIA	Processor - Data Processor	Modification - Major	3.25	1	2	0	2	0
Custom_Board: CRC	Processor - Data Processor	Modification - Average	3.25	1	2	0	2	0
General_I_F: LEU-D	Processor - Data Processor	Modification - Average	3.25	1	2	0	2	0
Analog_I_F: LEU-A	Processor - Data Processor	Modification - Average	3.25	1	2	0	2	0
Analog_I_F: physically located in Power subsystem; bookkept here	Power Supply	Modification - Average	3.25	1	2	0	2	0
Power: CEPCU	Power Supply	Modification - Average	3.25	1	2	0	2	0
General_I_F: MCIC	!~Communication s General	Modification - Major	3.25	1	2	0	2	0
Backplane: CPCI backplane (6 slots)	Interconnect - Backplane	Modification - Major	5.85	1	2	0	2	0
Chassis: CDH chassis (6 slot)	Electronic Enclosure - Space	Modification - Major	5.85	3	0	3.71	0	3.71
Backplane: CPCI backplane (4 slots)	Interconnect - Backplane	Modification - Major	5.85	1	2	0	2	0
Chassis: CDH chassis (4 slot)	Electronic Enclosure - Space	Modification - Major	5.85	3	0	2.47	0	2.47

Table D-16. MOSAIC SEER-H Setting and Model Inputs for Mothership and Mini-Mothership Spacecrafts.

Work Element Name	Application	Acquisition Category	Prototype Qty	Production Qty Yr 1	Mothership		Mini-Mothership	
					# Circuit Boards	Weight	# Circuit Boards	Weight
Power								
Solar Array, Roll Out Solar Array (ROSA), Two Deployable Wings,	Solar Array - Panel, Space	Modification - Major	1.5	0	0	148.46	0	148.46
High Voltage Down Converter (aka High Voltage Electronics Assy)	Power Supply - Electrical	Modification - Average	0.65	2	0	26	0	26
Battery, Secondary BatteryLi-ION	Battery - Lithium, Space	Modification - Major	0.65	1	0	25.45	0	25.45
EC INSPIRED Power Switch Slice - 32 H/L channels	Power Supply	Modification - Average	1.3	6	2	0	2	0
EC INSPIRED VALVE DRIVER Slice - 32 drivers	Power Supply	Modification - Average	0.65	1	2	0	2	0
EC INSPIRED THRUSTER DRIVER Slice - 32 drivers	Power Supply	Modification - Average	0.65	1	2	0	2	0
PSYCHE INSPIRED Housekeeping Power Converter Unit (HPCU)	Power Supply	Modification - Average	1.3	3	2	0	2	0
Diodes Assembly	Power Supply	Modification - Major	1.3	1	1	0	1	0
3-slot power chassis	Electronic Enclosure - Space	Modification - Major	1.3	1	0	1.24	0	1.24
CPCI backplane (4 slots)	Interconnect - Interconnect Board	Modification - Major	1.3	1	1	0	1	0
Propulsion								
System 1: SEP								
EP Xenon Feedsystem	Propulsion Components - Electric, Space	Make	0.65	3	0	4.32	0	4.32
PPU	Power Supply - Electrical	Make	0.65	3	0	55	0	55
Thruster Gimbals	Propulsion Thruster - Electric, Space	Modification - Major	0.65	3	0	4.8	0	4.8
EP Main Engine	Propulsion Thruster - Electric, Space	Modification - Average	0.65	3	0	51.7	0	51.7
Pressurant Tanks	Propulsion Tankage - Electric, Space	Modification - Major	0.65	2	0	40.1	0	40.1
System 2: Monoprop	0	0	0.65	1	0	0	0	0
Valves/Sensors/Transducers/Filters	Propulsion Components - Single Mode, Space	Make	0.65	1	0	2.59	0	2.59
Lines, Fittings, Misc.	Propulsion Components - Single Mode, Space	Make	1.5	0	0	2.7	0	2.7

Table D-16. MOSAIC SEER-H Setting and Model Inputs for Mothership and Mini-Mothership Spacecrafts.

Work Element Name	Application	Acquisition Category	Prototype Qty	Production Qty Yr 1	Mothership		Mini-Mothership	
					# Circuit Boards	Weight	# Circuit Boards	Weight
Monoprop Main Engine	Propulsion Thruster - Single Mode, Space	Modification - Average	1.5	8	0	0.17	0	0.17
Fuel Tanks	Propulsion Tankage - Single Mode, Space	Modification - Major	1.5	1	0	4.84	0	4.84
Mechanical & Structure								
Primary Structure	Primary Structure	Modification - Major	1.5	0	0	258.04	0	258.04
Secondary Structure	Secondary Structure	Modification - Major	1.5	0	0	52.71	0	52.71
Power/Telecom Mechanism	Precision Mechanism	Modification - Major	1.5	0	0	19.24	0	19.24
Balance/Ballast	Secondary Structure	Modification - Major	1.5	0	0	75.79	0	75.79
Adapter, Spacecraft side	Adapter	Modification - Major	1.5	0	0	21.41	0	21.41
Harness								
Harness	Harness - Space	Make	1.5	0	0	74.36	0	74.36
Telecom								
Ka-band HGA, Reflector Only, 3m	Antenna - Dish, Space	Modification - Average	1.5	0	0	8.9	0	8.9
Dual Band X-Ka Band HGA Feed	Antenna - Dish, Space	Modification - Average	1.5	0	0	1.76	0	1.76
X-band LGA, JUNO Toroidal	Antenna - Conical/Horn, Space	Modification - Average	1.5	2	0	2.15	0	2.15
UHF-LGA, MSL Helix	Antenna - Conical/Horn, Space	Modification - Average	1.5	2	0	0.9	0	0.9
UST Dual RX, Triple TX	Transponder - X-Band, Deep Space	Modification - Average	1.5	2	5	0	5	0
UST UHF Amp/Duplexer	RF Components - Space	Make	1.5	2	0	2.7	0	2.7
Ka-band TWTA RF=100-200W	Traveling Wave Tube Amplifier	Modification - Average	0.65	3	0	5.98	0	5.98
X-band TWTA, RF=25W	Traveling Wave Tube Amplifier	Modification - Average	1.5	1	0	3.3	0	3.3
X-band Diplexer, high isolation	RF Components - Space	Make	1.5	3	0	0.92	0	0.92
Ka-Band Filters Tx / Rx	RF Components - Space	Make	1.5	3	0	0.69	0	0.69
Ka-band Isolator	RF Components - Space	Make	1.5	3	0	0.58	0	0.58
Ka-Band Waveguide Transfer Switch	RF Components - Space	Make	1.5	5	0	0.17	0	0.17
X-Band Waveguide Transfer Switch	RF Components - Space	Make	1.5	11	0	0.52	0	0.52
X-band Isolator	RF Components - Space	Make	1.5	3	0	0.58	0	0.58
Coax Cable, flex (190)	Harness - Space	Make	1.5	23	0	0.08	0	0.08
WR-112 WG, rigid (Al)	Waveguide	Make	1.5	19	0	0.29	0	0.29

Table D-16. MOSAIC SEER-H Setting and Model Inputs for Mothership and Mini-Mothership Spacecrafts.

Work Element Name	Application	Acquisition Category	Prototype Qty	Production Qty Yr 1	Mothership		Mini-Mothership	
					# Circuit Boards	Weight	# Circuit Boards	Weight
WR-34 WG, rigid (Al)	Waveguide	Make	1.5	15	0	0.11	0	0.11
Thermal								
Multilayer Insulation (MLI)	Thermal Control - MLI/Paint/Coating	Modification - Major	1.5	54	0	0.49	0	0.49
Thermal Surfaces	Thermal Control - MLI/Paint/Coating	Modification - Major	1.5	1	0	6.82	0	6.82
Thermal Conduction Control	Thermal Control - Active	Modification - Major	1.5	0	0	1.59	0	1.59
Heaters	Thermal Control - Active	Modification - Major	1.5	1	0	7.57	0	7.57
Temperature Sensors	Thermal Control - Active	Modification - Major	1.5	259	0	0.01	0	0.01
Thermostats	Thermal Control - Active	Modification - Major	1.5	103	0	0.03	0	0.03
Heat Pipes	Radiator/Heat Pipe - Space	Modification - Major	1.5	46	0	0.2	0	0.2
Application KB abide with Acquisition Category settings in SEER's Space Guidance v3.1 Table 7.2								

D.5.3 True Planning

TruePlanning (version 16.1 SR1) was chosen as an additional validation of the MOSAIC project LCC. JPL has validated the TruePlanning framework against actuals for past missions and, as a result, uses the following settings: Operating Specification is 2.2 for planetary missions, and Table D-17 shows other settings for different mission classes.

Like SEER-H, TruePlanning is a mass-based model with additional inputs for operational environment, component functions, quantities, heritage, and a few other element unique parameters. Table D-18 shows the model inputs used for each component in the MEL include Function, Equipment types, heritage and unit mass (kg) for the mothership spacecraft.

Table D-17. MOSAIC TruePlanning high level setting for different mission classes.

Mission Class	Project Complexity			System Complexity		
	Top Level	SC	PL	Top Level	SC	PL
A (MOSAIC Mothership)	75	50	50	40	25	25
A (MOSAIC Baseline Constellation)	75	75	50	55	55	25
A/B	60	60	50	55	40	25
B	40	25	25	25	25	25

Table D-18. MOSAIC TruePlanning Setting and Model Inputs for Mothership and Mini-Mothership Spacecrafts.

Work Element Name	Function	Equipment Type	Heritage	Mothership	Mini-Mothership
				Mass (kg)	Mass (kg)
GN&C					
Sun Sensors	Spacecraft Attitude Control	Sun Sensor	Copy/Build to Print	0.14	0.14
Star Trackers		Star Tracker		4.73	4.73
IMUs		IMU/IRU		4.40	4.40
RWAs		Momentum/Reaction Wheel		13.20	9.90
Gimbal Drive Electronics		ACS Control Electronics		1.09	1.09
Command & Data					
Processor: Main box	Communications and Telemetry Tracking and Control	Spacecraft Control Processor	Minimal Mod	0.58	0.58
Memory: NVMCAM		Memory(Space)		0.75	
Telecom_I_F: MTIF		Data Interface		0.77	0.77
General_I_F: MSIA		Data Interface		0.75	0.75
Custom_Board: CRC		Data Handling(Space)	Significant Mod	0.27	0.27
General_I_F: LEU-D		Premodulator Processor	Minimal Mod	0.70	0.70
Analog_I_F: LEU-A		Premodulator Processor		0.58	0.58
Analog_I_F: physically located in Power subsystem; bookkept here		Demodulator(Space)		0.86	0.86
Power: CEPCU		Power Conditioner/Controller		1.21	1.21
General_I_F: MCIC		Premodulator Processor		0.77	0.77
Backplane: CPCI backplane (6 slots)		Data Interface	Significant Mod	0.78	0.78
Chassis: CDH chassis (6 slot)		Electronic Chassis/Housing		3.71	3.71
Backplane: CPCI backplane (4 slots)		Data Interface		0.52	
Chassis: CDH chassis (4 slot)		Electronic Chassis/Housing		2.47	
Power					
Solar Array, Roll Out Solar Array (ROSA), Two Deployable Wings,	Electrical Power	Solar Array	Significant Mod	221.98	148.46
High Voltage Down Converter (aka High Voltage Electronics Assy)		Power Converter(Space)		26.00	26.00
Battery, Secondary BatteryLi-ION		Battery		37.13	25.45
EC INSPIRED Power Switch Slice - 32 H/L channels		Switching Unit	Minimal Mod	1.94	1.94
EC INSPIRED VALVE DRIVER Slice - 32 drivers		Valve Driver		1.94	1.94
EC INSPIRED THRUSTER DRIVER Slice - 32 drivers		Power Supply Electronics(Space Electrics)		1.94	1.94
PSYCHE INSPIRED Housekeeping Power Converter Unit (HPCU)		Power Converter(Space)		1.26	1.26
Diodes Assembly		Power Supply Electronics(Space Electrics)	Significant Mod	0.26	0.26
3-slot power chassis		Electronic Chassis/Housing	New	1.24	1.24
CPCI backplane (4 slots)		Data Interface	Significant Mod	0.54	0.54
Propulsion					
System 1: SEP					
EP Xenon Feedsystem	Space Ion Thruster	Thruster	Minimal Mod	4.32	4.32
PPU	Space Electric Propulsion	Power Processing Unit		55.00	55.00

Table D-18. MOSAIC TruePlanning Setting and Model Inputs for Mothership and Mini-Mothership Spacecrafts.

Work Element Name	Function	Equipment Type	Heritage	Mothership	Mini-Mothership
				Mass (kg)	Mass (kg)
Thruster Gimbals	Structures and Mechanisms	Mechanisms		4.80	4.80
EP Main Engine		Thruster, XIPS		51.70	51.70
Pressurant Tanks		Tank, Pressurant		64.89	40.10
System 2: Monoprop					
Valves/Sensors/Transducers/ Filters	Propulsion	Squib Valve, Fill/Drain Valve	Minimal Mod	2.59	2.59
Lines, Fittings, Misc.		Lines/Fittings, Latch/Isolation Valves	New	2.70	2.70
Monoprop Main Engine		Thruster: 1 LB. - 110 LB.	Minimal Mod	0.17	0.17
Fuel Tanks		Tank, Propellant/Propulsion	Significant Mod	12.39	4.84
Mechanical & Structure					
Primary Structure	Structures and Mechanisms	Structure, Primary	Significant Mod	380.78	258.04
Secondary Structure		Structure, Panel		80.82	52.71
Power/Telecom Mechanism		Mechanisms		23.92	19.24
Balance/Ballast		Structure, Panel		102.95	75.79
Adapter, Spacecraft side		Structure, Panel		26.49	21.41
Harness					
Harness	Electrical Power	Cabling/Wiring Harness		106.10	74.36
Telecom					
Ka-band HGA, Reflector Only, 3m	Communications and Telemetry Tracking and Control	Antenna, Hi-Gain	Minimal Mod	21.96	8.90
Dual Band X-Ka Band HGA Feed		Antenna, Horn		1.76	1.76
X-band LGA, JUNO Toroidal		Antenna, Low/Medium Gain		2.15	2.15
UHF-LGA, MSL Helix		Antenna, VHF		0.90	0.90
UST Dual RX, Triple TX		Transponder(Space)		6.33	6.33
UST UHF Amp/Diplexer		Diplexer(Space)		2.70	2.70
Ka-band TWTA RF=100-200W		TWTA		5.98	5.98
X-band TWTA, RF=25W		TWTA		3.30	3.30
X-band Diplexer, high isolation		Diplexer(Space)		0.92	0.92
Ka-Band Filters Tx / Rx		RF Plumbing		0.69	0.69
Ka-band Isolator		Harness/Cabling/Waveguide		0.58	0.58
Ka-Band Waveguide Transfer Switch		Harness/Cabling/Waveguide		0.17	0.17
X-Band Waveguide Transfer Switch		Harness/Cabling/Waveguide		0.52	0.52
X-band Isolator		RF Plumbing		0.58	0.58
Coax Cable, flex (190)		Harness/Cabling/Waveguide		0.08	0.08
WR-112 WG, rigid (Al)		Harness/Cabling/Waveguide	New	0.29	0.29
WR-34 WG, rigid (Al)	Harness/Cabling/Waveguide		0.11	0.11	
Thermal					
Multilayer Insulation (MLI)	Thermal Control	MLI Blanket/Insulation/Paint/ Shroud	Significant Mod	0.49	0.49
Thermal Surfaces		MLI Blanket/Insulation/Paint/ Shroud		9.30	6.82
Thermal Conduction Control		MLI Blanket/Insulation/Paint/ Shroud		2.04	1.59
Heaters		Heater/Thermister/ Thermostat		7.96	7.57

Table D-18. MOSAIC TruePlanning Setting and Model Inputs for Mothership and Mini-Mothership Spacecrafts.

Work Element Name	Function	Equipment Type	Heritage	Mothership	Mini-Mothership
				Mass (kg)	Mass (kg)
Temperature Sensors		Heater/Thermister/ Thermostat		0.01	0.01
Thermostats		Heater/Thermister/ Thermostat		0.03	0.03
Heat Pipes		Heat Pipes		0.20	0.20

D.5.4 Space Operations Cost Model (SOCM)

The SOCM was used for the validation of Phase E/F. SOCM estimates the costs and staffing for space operations projects using high-level project characteristics that are typically known at the early stages of a project’s lifecycle. Running the cost model at Level 1 generates an estimate with an accuracy of $\pm 30\%$. The Level 1 Planetary inputs selected to reflect the MOSAIC mission are identified in Figure D-6. The only different input between the four combinations is the size of the Mothership and the number of instruments in each combination (MOSAIC Mothership, MOSAIC Mini-Mothership, MOSAIC Baseline Constellation, and MOSAIC Descope 1 Constellation). The SOCM results are summarized in Tables D-11, D-12, D-13, and D-14.

PLANETARY - LEVEL 1 INPUTS							
	Value ->	1	2	3	4	5	6
MISSION CHARACTERIZATION							
Mission Type	6	Planet Flyby	Atmospheric Probe	Satellite Flyby	Planet Flyby with Atmos Prb	Satellite Flyby with Atmos Prb	Orbiter
Target	3	Inner Planets (M,V)	Small Bodies	Mars	Outer Planets (J,S,U,N,P)		
# of Identical Flight Systems	1	1	2	3	4	5	6
Cruise Mission Duration (mo)	24						
Encounter Mission Duration (mo)	33						
Post-Flight Data Analysis Duration (mo)	4						
PROGRAMMATICS CHARACTERIZATION							
Mission Risk Class	4	Technology Demo (tech > sci)	Discovery, moderate risk	Medium, low risk	Major, minimum risk		
Development Schedule	3	Fast (< 2.5 yrs)	Moderate (2.5-4 yrs)	Long (> 4 yrs)			
GDS/MOS CHARACTERIZATION							
Lead Organization Level of Experience	3	Low	Average	Extensive			
MOS S/W Maturity/Heritage	2	Low	Average	Extensive			
# of Supporting Organizations	1	1	2	3	4	5	
PAYLOAD CHARACTERIZATION							
<i>Enter # of Instruments by Type:</i>							
Heat Probes	4		Science Instrument	160			
Accelerometers							
Lightning & Radio Emis Det.							
Atmospheric Structures Instr.							
Dust Detectors							
Magnetometers							
In Situ Mass Spectrometers							
Point Spectrometers							
Laser Altimeters							
Alpha Proton X-Ray Spectr.							
Radio Experiments							
Radar Altimeters							
Gamma Ray Spectrometers							
X-Ray Spectrometers							
Sample Acquisition Devices							
Imaging X-Ray Spectr.	3						
Electron Ion Mass Spectr.	8						
Multi-Spectral Imaging Systems							
Mapping Spectro. Systems							
Synthetic Aperture Radar	2						
S/C DESIGN CHARACTERIZATION							
S/C Design Implementation	3	High Heritage	Cost-Capped	Requirements-Driven			
Design Complexity	3	Low (minimal # of flight rules)	Medium	High (several unique engng reqs)			

Figure D-6. SOCM Level 1 Cost Input for MOSAIC Phase E (MOSAIC Baseline Constellation).

D.5.5 SSCM14

Small Satellite Cost Model version 2014 (SSCM14) is a parametric cost model, a series of mathematical relationships that relate spacecraft cost to physical, technical, and performance parameters that are known or believed to strongly influence spacecraft costs.

SSCM generates an estimate for Phases C and D of spacecraft development, and all cost are not included award fees. The funding profile is meant for the whole spacecraft development (Phases B, C, and D), the SSCM estimates add additional 10% of the development costs to account for Phase B cost and 17.5% to account for JPL subcontract fee.

Table D-19. Model Inputs Settings for MOSAIC’s Areo/Polar/Elliptical SmallSats platforms.

Technical Parameter	Units	Polar	Elliptical	Areo Mothership	Areo SmallSats
		Value	Value	Value	Value
Programmatic					
Fiscal Year for Estimate	YYYY	2025	2025	2025	2025
Inflation Methodology	---	1	1	1	1
Development Time	months	60.0	60.0	60.0	60.0
Calendar Year for Phase B Start	YYYY	2021	2021	2021	2021
Design Life	months	36.0	36.0	36.0	36.0
System					
Destination	---	2	2	2	2
Satellite Wet Mass	kg	73.1	183.8	664.7	93.0
Spacecraft Bus Dry Mass	kg	64.3	119.3	377.7	77.3
Number of Instruments	#	2	6	9	3
Power					
Solar Array Mounting Type	---	1	1	1	1
Solar Cell Type	---	1	1	1	1
Battery Type	---	2	2	2	2
Power Subsystem Mass	kg	3.7	9.4	42.1	14.5
BOL Power	W	140	282	150	100
Solar Array Area	m^2	3.00	1.80	12.54	1.20
Structure					
Primary Structure Material	---	1	1	1	1
Structure Subsystem Mass	kg	35.8	76.6	183.9	40.0
ADCS					
Star Tracker?	---	2	1	2	2
ADCS Subsystem Mass	kg	12.6	2.7	35.0	16.2
Pointing Control	deg	0.4	0.1	0.9	0.8
Propulsion					
Monopropellant or Bipropellant?	---	1	1	SEP	1
Propulsion Subsystem Dry Mass	kg	6.12	22.5	85.1	12.6
TT&C/C&DH					
Communications Band	---	1	1	1	1
TT&C/C&DH Subsystem Mass	kg	3.7	4.9	29.4	4.1
Transmit Power	W	8	6	8	5
Data Storage Capacity	MB	1024000	1024000	10000	7000
Thermal					
Thermal Subsystem Mass	kg	2.3	3.3	2.2	1.6

D.5.6 Elliptical SmallSats Additional Validation

The MOSAIC Elliptical SmallSats cost is very similar to the cost of the THEMIS bus. The MOSAIC and THEMIS instrumentation are identical except that MOSAIC ion analyzer is more complex, but there is no solid state telescope. See Table D-20 for further information.

Table D-20. MOSAIC Elliptical vs THEMIS SmallSats Validation (FY25 \$M).

Description	Team X	THEMIS (actuals)
MOSAIC Elliptical (2)	53.0	54.4

Appendix E References

- Abelson, R. et al., 2011, Juno Project Probabilistic Risk Assessment (PRA) Report, (Redacted of Potential LM-Proprietary Information)
- Adams, D, S Xu, DL Mitchell, RJ Lillis, M Fillingim, L Andersson, C Fowler, JEP Connerney, J Espley, and C Mazelle, 2018, Using magnetic topology to probe the sources of Mars' nightside ionosphere, *Geophysical Research Letters* 45, 22, 12,190-12,197.
- Akbari, H, L Andersson, WK Peterson, J Espley, M Benna, and R Ergun, 2019, Ambipolar electric field in the martian ionosphere: MAVEN measurements, *Journal of Geophysical Research: Space Physics* 124, 6, 4518-4524.
- Almatroushi, H., F. Lootah, G. Holsclaw, J. Deighan, M. Chaffin, EMUS Team, R. Lillis, M. Fillingim, and S. England, 2017, Scientific Payload of the Emirates Mars Mission: Emirates Mars Ultraviolet Spectrometer (EMUS) Overview, January 01, 2017, 4414. http://www-mars.lmd.jussieu.fr/granada2017/abstracts/almatroushi_granada2017_EMUS.pdf.
- Amiri, S, O Sharaf, S AlMheiri, A AlRais, M Wali, Z Al Shamsi, I Al Qasim, K Al Harmoodi, N Al Teneiji, and HR Almatroushi, 2017, Emirates Mars Mission (EMM) 2020 Overview, AGU Fall Meeting 2017, New Orleans, Louisiana, 2017, P34B-08.
- Anderson Jr, Donald E, and Charles W Hord, 1971, Mariner 6 and 7 ultraviolet spectrometer experiment: Analysis of hydrogen Lyman-alpha data, *Journal of Geophysical Research* 76, 28, 6666-6673.
- Andrews, David J, L Andersson, GT Delory, RE Ergun, Anders I Eriksson, CM Fowler, T McEnulty, MW Morooka, T Weber, and BM Jakosky, 2015, Ionospheric plasma density variations observed at Mars by MAVEN/LPW, *Geophysical Research Letters* 42, 21, 8862-8869.
- Angelopoulos, V, D Sibeck, CW Carlson, JP McFadden, D Larson, RP Lin, JW Bonnell, FS Mozer, R Ergun, and Christopher Cully, 2008, First results from the THEMIS mission, *Space Science Reviews* 141, 1-4, 453-476.
- ARRM. 2014. "down-select study PRA. Unpublished notes." circa. September 2014.
- Barabash, S, A Fedorov, JJ Sauvaud, R Lundin, CT Russell, Y Futaana, TL Zhang, H Andersson, K Brinkfeldt, and A Grigoriev, 2007, The loss of ions from Venus through the plasma wake, *Nature* 450, 7170, 650-653.
- Bass, Deborah S, Kenneth E Herkenhoff, and David A Paige, 2000, Variability of Mars' north polar water ice cap: I. Analysis of Mariner 9 and Viking Orbiter Imaging data, *Icarus* 144, 2, 382-396.
- Bayer, Todd J, 2008, In-Flight Anomalies and Lessons Learned from the Mars Reconnaissance Orbiter Mission, 2008 IEEE Aerospace Conference, IEEE Computer Society, IEEE, 1-13. doi:10.1109/AERO.2008.4526483.
- Beaty, D, M Carr, and et al., 2012, Analysis of strategic knowledge gaps associated with potential human missions to the Martian system: Final report of the Precursor Strategy Analysis Group (P-SAG). 72. https://mepag.jpl.nasa.gov/reports/P-SAG_final_report_06-30-12_main_v26.pdf.
- Benna, M., S. W. Bougher, Y. Lee, K. J. Roeten, and P. Mahaffy, 2019, MAVEN reveals the Global Circulation of the Upper-Atmosphere of Mars, *Geophysical Research Letters*, submitted.
- Benna, M, PR Mahaffy, JM Grebowsky, Jane L Fox, Roger V Yelle, and Bruce M Jakosky, 2015, First measurements of composition and dynamics of the Martian ionosphere by MAVEN's Neutral Gas and Ion Mass Spectrometer, *Geophysical Research Letters* 42, 21, 8958-8965.
- Benson, Jennifer L, and Philip B James, 2005, Yearly comparisons of the Martian polar caps: 1999–2003 Mars Orbiter Camera observations, *Icarus* 174, 2, 513-523.

- Bertrand, Tanguy, R John Wilson, Melinda A Kahre, Richard Urata, and Alex Kling, 2020, Simulation of the 2018 Global Dust Storm on Mars Using the NASA Ames Mars GCM: A Multitracer Approach, *Journal of Geophysical Research: Planets* 125, 7, e2019JE006122.
- Bhattacharyya, D, Jean-Yves Chaufray, M Mayyasi, JT Clarke, S Stone, RV Yelle, W Pryor, Jean-Loup Bertaux, J Deighan, and SK Jain, 2020, Two-dimensional model for the martian exosphere: Applications to hydrogen and deuterium Lyman α observations, *Icarus* 339, 113573.
- Bhattacharyya, D, JT Clarke, Jean-Yves Chaufray, M Mayyasi, Jean-Loup Bertaux, MS Chaffin, NM Schneider, and GL Villanueva, 2017, Seasonal changes in hydrogen escape from Mars through analysis of HST observations of the Martian exosphere near perihelion, *Journal of Geophysical Research: Space Physics* 122, 11, 11756-11764.
- Bhattacharyya, Dolon, John T Clarke, Jean-Loup Bertaux, Jean-Yves Chaufray, and Majd Mayyasi, 2015, A strong seasonal dependence in the Martian hydrogen exosphere, *Geophysical Research Letters* 42, 20, 8678-8685.
- Böttger, HM, SR Lewis, PL Read, and F Forget, 2004, The effect of a global dust storm on simulations of the Martian water cycle, *Geophysical research letters* 31, 22.
- Bougher, SW, D Pawlowski, JM Bell, S Nelli, T McDunn, JR Murphy, M Chizek, and A Ridley, 2015, Mars Global Ionosphere-Thermosphere Model: Solar cycle, seasonal, and diurnal variations of the Mars upper atmosphere, *Journal of Geophysical Research: Planets* 120, 2, 311-342.
- Bougher, Stephen W, Kali J Roeten, Kirk Olsen, Paul R Mahaffy, Mehdi Benna, Meredith Elrod, Sonal K Jain, Nicholas M Schneider, Justin Deighan, and Ed Thiemann, 2017, The structure and variability of Mars dayside thermosphere from MAVEN NGIMS and IUVS measurements: Seasonal and solar activity trends in scale heights and temperatures, *Journal of Geophysical Research: Space Physics* 122, 1, 1296-1313.
- Box, George EP, and George C Tiao, 1973, Bayesian inference in statistical analysis, Vol. 40, John Wiley & Sons, Inc., New York.
- Boynton, William V, WC Feldman, SW Squyres, TH Prettyman, J Brückner, LG Evans, RC Reedy, R Starr, JR Arnold, and DM Drake, 2002, Distribution of hydrogen in the near surface of Mars: Evidence for subsurface ice deposits, *science* 297, 5578, 81-85.
- Brain, David, James McFadden, Jasper Halekas, Jack Connerney, Frank Eparvier, Stephen Bougher, Charlie Bowers, Shannon Curry, Yaxue Dong, and Chuanfei Dong, 2016, Variability in the loss of ions from the Martian atmosphere, EGUGA, EPSC2016-11657.
- Brain, David A, JP McFadden, Jasper S Halekas, JEP Connerney, Stephen W Bougher, Shannon Curry, CF Dong, Y Dong, F Eparvier, and Xiaohua Fang, 2015, The spatial distribution of planetary ion fluxes near Mars observed by MAVEN, *Geophysical Research Letters* 42, 21, 9142-9148.
- Bramson, Ali M, Shane Byrne, Nathaniel E Putzig, Sarah Sutton, Jeffrey J Plaut, T Charles Brothers, and John W Holt, 2015, Widespread excess ice in Arcadia Planitia, Mars, *Geophysical Research Letters* 42, 16, 6566-6574.
- Brothers, TC, JW Holt, and A Spiga, 2015, Planum Boreum basal unit topography, Mars: Irregularities and insights from SHARAD, *Journal of Geophysical Research: Planets* 120, 7, 1357-1375.
- Byrne, Shane, Colin M Dundas, Megan R Kennedy, Michael T Mellon, Alfred S McEwen, Selby C Cull, Ingrid J Daubar, David E Shean, Kimberly D Seelos, and Scott L Murchie, 2009, Distribution of mid-latitude ground ice on Mars from new impact craters, *science* 325, 5948, 1674-1676.
- Calvin, WM, PB James, BA Cantor, and EM Dixon, 2015, Interannual and seasonal changes in the north polar ice deposits of Mars: Observations from MY 29–31 using MARCI, *Icarus* 251, 181-190.

- Campbell, Bruce A, John A Grant, Ted Maxwell, Jeffrey J Plaut, and Anthony Freeman, 2017, Exploring The Shallow Subsurface Of Mars With Imaging Radar: Scientific Promise And Technical Rationale.
<http://citeseerx.ist.psu.edu/viewdoc/download?doi=10.1.1.729.51&rep=rep1&type=pdf>.
- Cantor, Bruce A, 2007, MOC observations of the 2001 Mars planet-encircling dust storm, *Icarus* 186, 1, 60-96. doi:10.1016/j.icarus.2006.08.019.
- Center, Glenn Research. "About Glenn - History." accessed June 13, 2020.
<https://www.nasa.gov/centers/glenn/about/history/ds1opseq.html>.
- Chaffin, MS, Jean-Yves Chaufray, J Deighan, NM Schneider, M Mayyasi, JT Clarke, E Thiemann, SK Jain, MMJ Crismani, and Arnaud Stiepen, 2018, Mars H escape rates derived from MAVEN/IUVS Lyman alpha brightness measurements and their dependence on model assumptions, *Journal of Geophysical Research: Planets* 123, 8, 2192-2210.
- Chaffin, MS, J Deighan, NM Schneider, and AIF Stewart, 2017, Elevated atmospheric escape of atomic hydrogen from Mars induced by high-altitude water, *Nature Geoscience* 10, 3, 174-178.
- Chaffin, MS, DM Kass, S Aoki, AA Fedorova, J Deighan, J-Y Chaufray, K Connour, NG Heavens, A Kleinboehl, and SK Jain, 2019, Mars Climate Controls Atmospheric Escape: Dust-Driven Escape from Surface to Space with MRO/MCS, TGO/NOMAD, TGO/ACS, and MAVEN/IUVS, *LPI Contributions* 2089, 6312.
- Chaffin, Michael S, Jean-Yves Chaufray, Ian Stewart, Franck Montmessin, Nicholas M Schneider, and Jean-Loup Bertaux, 2014, Unexpected variability of Martian hydrogen escape, *Geophysical Research Letters* 41, 2, 314-320. doi:10.1002/2013GL058578.
- Chaffin, Michael S, Jean-Yves Chaufray, Justin Deighan, Nick M Schneider, William E McClintock, A Ian F Stewart, E Thiemann, John T Clarke, Greg M Holsclaw, and Sonal K Jain, 2015, Three-dimensional structure in the Mars H corona revealed by IUVS on MAVEN, *Geophysical Research Letters* 42, 21, 9001-9008.
- Chalupa, Rudolf, 2019, Failure Modes, Effects and Diagnostic Analysis, ROS 14-09-201 R001, 3, 2.
- Chaufray, J-Y, Francisco Gonzalez-Galindo, François Forget, Miguel A Lopez-Valverde, François Leblanc, Ronan Modolo, and Sebastien Hess, 2015, Variability of the hydrogen in the Martian upper atmosphere as simulated by a 3D atmosphere–exosphere coupling, *Icarus* 245, 282-294.
- Clancy, R. T., F. Montmessin, J. Benson, F. Daerden, A. Colaprete, and M. J. Wolff, 2017, Mars clouds, In *The atmosphere and climate of Mars*, edited by Robert M Haberle, R Todd Clancy, François Forget, Michael D Smith and Richard W Zurek, Cambridge University Press, 76-105.
- Clancy, R Todd, Michael J Wolff, Barbara A Whitney, Bruce A Cantor, Michael D Smith, and Timothy H McConnochie, 2010, Extension of atmospheric dust loading to high altitudes during the 2001 Mars dust storm: MGS TES limb observations, *Icarus* 207, 1, 98-109.
- Clarke, John T, J-L Bertaux, J-Y Chaufray, G Randall Gladstone, Eric Quémerais, JK Wilson, and Dolon Bhattacharyya, 2014, A rapid decrease of the hydrogen corona of Mars, *Geophysical Research Letters* 41, 22, 8013-8020.
- Clifford, Stephen M, 1993, A model for the hydrologic and climatic behavior of water on Mars, *Journal of Geophysical Research: Planets* 98, E6, 10973-11016.
- Clifford, Stephen M, and Daniel Hillel, 1983, The stability of ground ice in the equatorial region of Mars, *Journal of Geophysical Research: Solid Earth* 88, B3, 2456-2474.
- Colaprete, Anthony, Robert M Haberle, and Owen B Toon, 2003, Formation of convective carbon dioxide clouds near the south pole of Mars, *Journal of Geophysical Research: Planets* 108, E7.
- Colaprete, Anthony, and Owen B Toon, 2002, Carbon dioxide snow storms during the polar night on Mars, *Journal of Geophysical Research: Planets* 107, E7, 5-1-5-16.
- Collinson, Glyn, Lynn B Wilson III, Nick Omid, David Sibeck, Jared Espley, Christopher M Fowler, David Mitchell, Joseph Grebowsky, Christian Mazelle, and Suranga Ruhunusiri, 2018, Solar wind induced waves in the skies of Mars: Ionospheric compression, energization, and escape

- resulting from the impact of ultralow frequency magnetosonic waves generated upstream of the Martian bow shock, *Journal of Geophysical Research: Space Physics* 123, 9, 7241-7256.
- Conrath, Barney J, John C Pearl, Michael D Smith, William C Maguire, Philip R Christensen, Shymala Dason, and Monte S Kaelberer, 2000, Mars Global Surveyor Thermal Emission Spectrometer (TES) observations: Atmospheric temperatures during aerobraking and science phasing, *Journal of Geophysical Research: Planets* 105, E4, 9509-9519.
- Cravens, Thomas, Ali Rahmati, Robert J Lillis, Jane Lee Fox, Stephen W Bougher, and Bruce Martin Jakosky, 2016, Dependence of Photochemical Escape of Oxygen at Mars on Solar Radiation and Solar Wind Interaction, AGUFM, P12A-07.
- Cremons, Daniel R, James B Abshire, Xiaoli Sun, Graham Allan, Haris Riris, Michael D Smith, Scott Guzewich, Anthony Yu, and Floyd Hovis, 2020, Design of a direct-detection wind and aerosol lidar for mars orbit, *CEAS Space Journal*, 1-14. doi:10.1007/s12567-020-00301-z.
- Crooker, NU, SW Kahler, JT Gosling, DE Larson, RP Lepping, EJ Smith, and J De Keyser, 2001, Scales of heliospheric current sheet coherence between 1 and 5 AU, *Journal of Geophysical Research: Space Physics* 106, A8, 15963-15971. doi:10.1029/2000ja000109.
- Curry, Shannon, Janet Luhmann, Bruce M Jakosky, David Brain, Francis Leblanc, Ronan Modolo, Jasper S Halekas, Nicholas M Schneider, Justin Deighan, and James Mcfadden, 2016, MAVEN observations of atmospheric loss at Mars, *AAS* 228, 213.01.
- Decadal Survey, Committee on the Planetary Science, 2011, *Vision and Voyages: For Planetary Science in the Decade 2013-2022*.
- Deighan, Justin, MS Chaffin, J-Y Chaufray, A Ian F Stewart, NM Schneider, Sonal K Jain, Arnaud Stiepen, Matteo Crismani, William E McClintock, and John T Clarke, 2015, MAVEN IUUVS observation of the hot oxygen corona at Mars, *Geophysical Research Letters* 42, 21, 9009-9014.
- Deighan, Justin, SK Jain, MS Chaffin, Xiaohua Fang, Jasper S Halekas, John T Clarke, NM Schneider, AIF Stewart, J-Y Chaufray, and JS Evans, 2018, Discovery of a proton aurora at Mars, *Nature Astronomy* 2, 10, 802-807.
- Denson, William, Greg Chandler, William Crowell, and Rick Wanner, 1991, Nonelectronic parts reliability data 1991. NPRD-91.
- DiBraccio, Gina A, Julian Dann, Jared R Espley, Jacob R Gruesbeck, Yasir Soobiah, John EP Connerney, Jasper S Halekas, Yuki Harada, Charles F Bowers, and David A Brain, 2017, MAVEN observations of tail current sheet flapping at Mars, *Journal of Geophysical Research: Space Physics* 122, 4, 4308-4324. doi:10.1002/2016ja023488.
- Dong, Y, X Fang, DA Brain, JP McFadden, JS Halekas, JE Connerney, SM Curry, Y Harada, JG Luhmann, and BM Jakosky, 2015, Strong plume fluxes at Mars observed by MAVEN: An important planetary ion escape channel, *Geophysical Research Letters* 42, 21, 8942-8950.
- Dong, Y, X Fang, DA Brain, JP McFadden, JS Halekas, JEP Connerney, F Eparvier, L Andersson, D Mitchell, and BM Jakosky, 2017, Seasonal variability of Martian ion escape through the plume and tail from MAVEN observations, *Journal of Geophysical Research: Space Physics* 122, 4, 4009-4022. doi:10.1002/2016ja023517.
- Drouin, Brian, and Tristan S L'Ecuyer, 2018, Polar Radiant Energy in the Far-Infrared Experiment (prefire), *International Symposium on Molecular Spectroscopy*, Urbana Champaign, IL. <https://www.ideals.illinois.edu/handle/2142/100641>.
- Dubinin, E, G Chanteur, M Fraenz, R Modolo, J Woch, E Roussos, S Barabash, R Lundin, and JD Winningham, 2008, Asymmetry of plasma fluxes at Mars. ASPERA-3 observations and hybrid simulations, *Planetary and Space Science* 56, 6, 832-835. doi:10.1016/j.pss.2007.12.006.
- Dubinin, E, M Fraenz, M Pätzold, D Andrews, O Vaisberg, L Zelenyi, and S Barabash, 2017, Martian ionosphere observed by Mars Express. 2. Influence of solar irradiance on upper ionosphere and escape fluxes, *Planetary and Space Science* 145, 1-8.

- Dubinin, E, M Fraenz, M Pätzold, J McFadden, JS Halekas, GA DiBraccio, JEP Connerney, F Eparvier, D Brain, and BM Jakosky, 2017, The effect of solar wind variations on the escape of oxygen ions from Mars through different channels: MAVEN observations, *Journal of Geophysical Research: Space Physics* 122, 11, 11,285-11,301. doi:10.1002/2017ja024741.
- Dubinin, E, M Fraenz, M Pätzold, J McFadden, PR Mahaffy, F Eparvier, JS Halekas, JEP Connerney, D Brain, and BM Jakosky, 2017, Effects of solar irradiance on the upper ionosphere and oxygen ion escape at Mars: MAVEN observations, *Journal of Geophysical Research: Space Physics* 122, 7, 7142-7152.
- Dubinin, E, M Fraenz, J Woch, Ronan Modolo, Gérard Chanteur, F Duru, DA Gurnett, S Barabash, and R Lundin, 2012, Upper ionosphere of Mars is not axially symmetrical, *Earth, Planets and Space* 64, 2, 7. doi:10.5047/eps.2011.05.022.
- Dubinin, E, Markus Fränz, M Pätzold, J McFadden, JS Halekas, JEP Connerney, BM Jakosky, O Vaisberg, and L Zelenyi, 2018, Martian ionosphere observed by MAVEN. 3. Influence of solar wind and IMF on upper ionosphere, *Planetary and Space Science* 160, 56-65.
- Dundas, Colin M, and Shane Byrne, 2010, Modeling sublimation of ice exposed by new impacts in the martian mid-latitudes, *Icarus* 206, 2, 716-728.
- Duru, F, DA Gurnett, DD Morgan, R Modolo, AF Nagy, and D Najib, 2008, Electron densities in the upper ionosphere of Mars from the excitation of electron plasma oscillations, *Journal of Geophysical Research: Space Physics* 113, A7. doi:10.1029/2008ja013073.
- Edberg, NJT, DA Brain, M Lester, SWH Cowley, R Modolo, M Fränz, and S Barabash, 2009, Plasma boundary variability at Mars as observed by Mars Global Surveyor and Mars Express, *Annales Geophysicae: Atmospheres, Hydrospheres and Space Sciences*, 27, 3537.
- Edberg, NJT, H Nilsson, AO Williams, M Lester, SE Milan, SWH Cowley, M Fränz, S Barabash, and Y Futaana, 2010, Pumping out the atmosphere of Mars through solar wind pressure pulses, *Geophysical Research Letters* 37, 3. doi:10.1029/2009gl041814.
- Elrod, MK, Steven Bougher, Kali Roeten, R Sharrar, and J Murphy, 2019, Structural and Compositional Changes in the Upper Atmosphere Related to the PEDE-2018a Dust Event on Mars as Observed by MAVEN NGIMS, *LPICo* 2089, 6338.
- England, Scott L, Guiping Liu, Paul Withers, Erdal Yiğit, Daniel Lo, Sonal Jain, Nicholas M Schneider, Justin Deighan, William E McClintock, and Paul R Mahaffy, 2016, Simultaneous observations of atmospheric tides from combined in situ and remote observations at Mars from the MAVEN spacecraft, *Journal of Geophysical Research: Planets* 121, 4, 594-607.
- Englert, Christoph R, John M Harlander, Charles M Brown, Kenneth D Marr, Ian J Miller, J Eloise Stump, Jed Hancock, James Q Peterson, Jay Kumler, and William H Morrow, 2017, Michelson interferometer for global high-resolution thermospheric imaging (MIGHTI): instrument design and calibration, *Space science reviews* 212, 1-2, 553-584. doi:10.1007/s11214-017-0358-4.
- Fedorova, Anna, Jean-Loup Bertaux, Daria Betsis, Franck Montmessin, Oleg Korablev, Luca Maltagliati, and John Clarke, 2018, Water vapor in the middle atmosphere of Mars during the 2007 global dust storm, *Icarus* 300, 440-457.
- Feldman, William C, Michael T Mellon, Olivier Gasnault, B Diez, RC Elphic, Justin J Hagerty, DJ Lawrence, S Maurice, and TH Prettyman, 2007, Vertical distribution of hydrogen at high northern latitudes on Mars: The Mars Odyssey Neutron Spectrometer, *Geophysical research letters* 34, 5.
- Feldman, William C, Thomas H Prettyman, Sylvestre Maurice, JJ Plaut, DL Bish, DT Vaniman, MT Mellon, AE Metzger, SW Squyres, and S Karunatillake, 2004, Global distribution of near-surface hydrogen on Mars, *Journal of Geophysical Research: Planets* 109, E9.
- Flynn, Casey L, Marissa F Vogt, Paul Withers, Laila Andersson, Scott England, and Guiping Liu, 2017, MAVEN observations of the effects of crustal magnetic fields on electron density and

- temperature in the Martian dayside ionosphere, *Geophysical Research Letters* 44, 21, 10,812-10,821.
- Forget, François, Frédéric Hourdin, Richard Fournier, Christophe Hourdin, Olivier Talagrand, Matthew Collins, Stephen R Lewis, Peter L Read, and Jean-Paul Huot, 1999, Improved general circulation models of the Martian atmosphere from the surface to above 80 km, *Journal of Geophysical Research: Planets* 104, E10, 24155-24175.
- Fowler, CM, L Andersson, RE Ergun, Y Harada, T Hara, G Collinson, WK Peterson, J Espley, J Halekas, and J Mcfadden, 2018, MAVEN observations of solar wind-driven magnetosonic waves heating the Martian dayside ionosphere, *Journal of Geophysical Research: Space Physics* 123, 5, 4129-4149.
- Fowler, CM, L Andersson, J Halekas, JR Espley, C Mazelle, ER Coughlin, RE Ergun, David J Andrews, JEP Connerney, and B Jakosky, 2017, Electric and magnetic variations in the near-Mars environment, *Journal of Geophysical Research: Space Physics* 122, 8, 8536-8559.
- Fowler, CM, L Andersson, WK Peterson, J Halekas, AF Nagy, RE Ergun, J Espley, DL Mitchell, JEP Connerney, and C Mazelle, 2018, Correlations between enhanced electron temperatures and electric field wave power in the Martian ionosphere, *Geophysical Research Letters* 45, 2, 493-501.
- Franklin, Stephen F, JP Slonski, Stuart Kerridge, Gary Noreena, S Townes, E Schwartzbaum, S Synnott, M Deutsch, C Edwards, and A Devereaux, 2004, The 2009 Mars Telecom Orbiter Mission, 2004 IEEE Aerospace Conference Proceedings, IEEE Computer Society, IEEE, March 5-12, 2005, 1. doi:10.1109/AERO.2005.1559337.
- Freeman, Anthony, Suzanne E Smrekar, Scott Hensley, Mark Wallace, Christophe Sotin, Murray Darrach, Peter Xaypraseuth, Joern Helbert, and Erwan Mazarico, 2016, VERITAS: A Discovery-class Venus surface geology and geophysics mission. https://trs.jpl.nasa.gov/bitstream/handle/2014/45906/15-4648_A1b.pdf.
- Fuselier, SA, WS Lewis, C Schiff, R Ergun, JL Burch, SM Petrinec, and KJ Trattner, 2016, Magnetospheric multiscale science mission profile and operations, *Space Science Reviews* 199, 1-4, 77-103.
- Girazian, Z, P Mahaffy, RJ Lillis, M Benna, M Elrod, CM Fowler, and DL Mitchell, 2017, Ion densities in the nightside ionosphere of Mars: Effects of electron impact ionization, *Geophysical research letters* 44, 22, 11,248-11,256.
- Girazian, Z, PR Mahaffy, RJ Lillis, Mehdi Benna, M Elrod, and BM Jakosky, 2017, Nightside ionosphere of Mars: Composition, vertical structure, and variability, *Journal of Geophysical Research: Space Physics* 122, 4, 4712-4725.
- Girerd, Andre R., Leila Meshkat, Charles D. Edwards, Jr., and Charles H. Lee, 2006, A model to assess the mars telecommunications network relay robustness, *Journal of the British Interplanetary Society* 59, 12, 443-449.
- González-Galindo, F, J-Y Chaufray, MA López-Valverde, G Gilli, François Forget, François Leblanc, Ronan Modolo, Sebastien Hess, and M Yagi, 2013, Three-dimensional Martian ionosphere model: I. The photochemical ionosphere below 180 km, *Journal of Geophysical Research: Planets* 118, 10, 2105-2123.
- Graf, James E, Richard W Zurek, Howard J Eisen, Benhan Jai, MD Johnston, and Ramon DePaula, 2004, The Mars reconnaissance orbiter mission, *Infinite Possibilities Global Realities, Selected Proceedings of the 55th International Astronautical Federation Congress, Vancouver, Canada, October 4-8, 2004*, 57, 566-578. doi:10.1016/j.actaastro.2005.03.043.
- Gurnett, DA, RL Huff, DD Morgan, AM Persoon, TF Averkamp, DL Kirchner, F Duru, F Akalin, AJ Kopf, and E Nielsen, 2008, An overview of radar soundings of the Martian ionosphere from the Mars Express spacecraft, *Advances in Space Research* 41, 9, 1335-1346. doi:10.1016/j.asr.2007.01.062.

- Gustafsson, Georg, M André, T Carozzi, Anders I Eriksson, C-G Fälthammar, R Grard, G Holmgren, JA Holtet, N Ivchenko, and Tomas Karlsson, 2001, First results of electric field and density observations by Cluster EFW based on initial months of operation, *Annales Geophysicae* 19, 10/12, 1219-1240.
- Guzewich, Scott D, AD Toigo, and DW Waugh, 2016, The effect of dust on the martian polar vortices, *Icarus* 278, 100-118.
- Guzewich, Scott D, R John Wilson, Timothy H McConnochie, Anthony D Toigo, Donald J Banfield, and Michael D Smith, 2014, Thermal tides during the 2001 Martian global-scale dust storm, *Journal of Geophysical Research: Planets* 119, 3, 506-519.
- Haberle, Robert M, James B Pollack, Jeffrey R Barnes, Richard W Zurek, Conway B Leovy, James R Murphy, Hilda Lee, and James Schaeffer, 1993, Mars atmospheric dynamics as simulated by the NASA Ames General Circulation Model: 1. The zonal-mean circulation, *Journal of Geophysical Research: Planets* 98, E2, 3093-3123.
- Halekas, JS, 2017, Seasonal variability of the hydrogen exosphere of Mars, *Journal of Geophysical Research: Planets* 122, 5, 901-911.
- Halekas, JS, DA Brain, JG Luhmann, GA DiBraccio, S Ruhunusiri, Y Harada, CM Fowler, DL Mitchell, JEP Connerney, and JR Espley, 2017, Flows, fields, and forces in the Mars-solar wind interaction, *Journal of Geophysical Research: Space Physics* 122, 11, 11,320-11,341. doi:10.1002/2017ja024772.
- Halekas, JS, DA Brain, S Ruhunusiri, JP McFadden, DL Mitchell, C Mazelle, JEP Connerney, Y Harada, T Hara, and JR Espley, 2016, Plasma clouds and snowplows: Bulk plasma escape from Mars observed by MAVEN, *Geophysical Research Letters* 43, 4, 1426-1434.
- Halekas, JS, S Ruhunusiri, Y Harada, G Collinson, DL Mitchell, C Mazelle, JP McFadden, JEP Connerney, JR Espley, and F Eparvier, 2017, Structure, dynamics, and seasonal variability of the Mars-solar wind interaction: MAVEN Solar Wind Ion Analyzer in-flight performance and science results, *Journal of Geophysical Research: Space Physics* 122, 1, 547-578.
- Hara, Takuya, Janet G Luhmann, François Leblanc, Shannon M Curry, Kanako Seki, David A Brain, Jasper S Halekas, Yuki Harada, James P McFadden, and Roberto Livi, 2017, MAVEN observations on a hemispheric asymmetry of precipitating ions toward the Martian upper atmosphere according to the upstream solar wind electric field, *Journal of Geophysical Research: Space Physics* 122, 1, 1083-1101. doi:10.1002/2016JA023348.
- Harada, Y, DA Gurnett, AJ Kopf, JS Halekas, S Ruhunusiri, CO Lee, T Hara, J Espley, GA DiBraccio, and DL Mitchell, 2017, Dynamic response of the Martian ionosphere to an interplanetary shock: Mars Express and MAVEN observations, *Geophysical Research Letters* 44, 18, 9116-9123. doi:10.1002/2017gl074897.
- Harada, Y, JS Halekas, JP McFadden, J Espley, GA DiBraccio, DL Mitchell, C Mazelle, DA Brain, L Andersson, and YJ Ma, 2017, Survey of magnetic reconnection signatures in the Martian magnetotail with MAVEN, *Journal of Geophysical Research: Space Physics* 122, 5, 5114-5131. doi:10.1002/2017JA023952.
- Havens, Glen, 2007, Systems Engineering Challenges on Mars Reconnaissance Orbiter Mission, AIAA Space 2007 Conference & Exposition, 6091.
- Hayne, Paul O, David A Paige, and Nicholas G Heavens, 2014, The role of snowfall in forming the seasonal ice caps of Mars: Models and constraints from the Mars Climate Sounder, *Icarus* 231, 122-130.
- Hayne, Paul O, David A Paige, John T Schofield, David M Kass, Armin Kleinböhl, Nicholas G Heavens, and Daniel J McCleese, 2012, Carbon dioxide snow clouds on Mars: South polar winter observations by the Mars Climate Sounder, *Journal of Geophysical Research: Planets* 117, E8.

- Hays, Paul B, Vincent J Abreu, Michael E Dobbs, David A Gell, Heinz J Grassl, and Wilbert R Skinner, 1993, The high-resolution doppler imager on the Upper Atmosphere Research Satellite, *Journal of Geophysical Research: Atmospheres* 98, D6, 10713-10723. doi:10.1029/93JD00409.
- Heavens, NG, 2017, Textured dust storm activity in northeast Amazonis–southwest Arcadia, Mars: Phenomenology and dynamical interpretation, *Journal of the Atmospheric Sciences* 74, 4, 1011-1037.
- Heavens, NG, BA Cantor, PO Hayne, DM Kass, A Kleinböhl, DJ McCleese, S Piqueux, JT Schofield, and JH Shirley, 2015, Extreme detached dust layers near Martian volcanoes: Evidence for dust transport by mesoscale circulations forced by high topography, *Geophysical Research Letters* 42, 10, 3730-3738.
- Heavens, Nicholas G, Armin Kleinböhl, Michael S Chaffin, Jasper S Halekas, David M Kass, Paul O Hayne, Daniel J McCleese, Sylvain Piqueux, James H Shirley, and John T Schofield, 2018, Hydrogen escape from Mars enhanced by deep convection in dust storms, *Nature Astronomy* 2, 2, 126-132.
- Hollingsworth, JL, and MA Kahre, 2010, Extratropical cyclones, frontal waves, and Mars dust: Modeling and considerations, *Geophysical research letters* 37, 22.
- Hughes, Andréa, Michael Chaffin, Edwin Mierkiewicz, Justin Deighan, Sonal Jain, Nicholas Schneider, Majd Mayyasi, and Bruce Jakosky, 2019, Proton Aurora on Mars: A Dayside Phenomenon Pervasive in Southern Summer, *Journal of Geophysical Research: Space Physics* 124, 12, 10533-10548.
- Jagpal, Rajinder K, Brendan M Quine, Hugh Chesser, Sanjar Abrarov, and Regina Lee, 2010, Calibration and in-orbit performance of the Argus 1000 spectrometer-the Canadian pollution monitor, *Journal of Applied Remote Sensing* 4, 1, 049501. doi:10.1117/1.3302405.
- Jai, Ben, Daniel Wenkert, Tim Halbrook, and Wayne Sidney, 2006, The Mars Reconnaissance Orbiter Mission Operations: Architecture, Approach and Status, SpaceOps 2006 Conference, 9th International Conference on Space Operations, June 19-23, 2006, 5956.
- Jain, Sonal K, A Ian F Stewart, Nick M Schneider, Justin Deighan, Arnaud Stiepen, J Scott Evans, Michael H Stevens, Michael S Chaffin, Matteo Crismani, and William E McClintock, 2015, The structure and variability of Mars upper atmosphere as seen in MAVEN/IUVS dayglow observations, *Geophysical Research Letters* 42, 21, 9023-9030.
- Jakosky, B, 2018, MAVEN Project Status and Recent Science Results, 36th meeting of the Mars Exploration Program Analysis Group, Crystal City, Virginia, April 4, 2018. https://mepag.jpl.nasa.gov/meeting/2018-04/21_jakosky-mepag-4apr2018-v4.pdf.
- Jakosky, BM, David Brain, Michael Chaffin, S Curry, Justin Deighan, Joseph Grebowsky, Jasper Halekas, François Leblanc, Robert Lillis, and JG Luhmann, 2018, Loss of the Martian atmosphere to space: Present-day loss rates determined from MAVEN observations and integrated loss through time, *Icarus* 315, 146-157.
- Jakosky, Bruce M, and Robert M Haberle, 1990, Year-to-year instability of the Mars south polar cap, *Journal of Geophysical Research: Solid Earth* 95, B2, 1359-1365.
- Jakosky, Bruce M, RP Lin, JM Grebowsky, JG Luhmann, DF Mitchell, G Beutelschies, T Priser, M Acuna, L Andersson, and D Baird, 2015, The Mars atmosphere and volatile evolution (MAVEN) mission, *Space Science Reviews* 195, 1-4, 3-48.
- Johnston, MD Dan, James E Graf, Richard W Zurek, Howard J Eisen, and Benhan Jai, 2005, The Mars reconnaissance orbiter mission, 2005 IEEE Aerospace Conference, IEEE Computer Society, IEEE, March 5-12, 2005, 447-464. doi:10.1109/AERO.2005.1559336.
- Johnston, Martin D, James E Graf, Richard W Zurek, Howard J Eisen, and Benhan Jai, 2007, The Mars Reconnaissance Orbiter Mission: from launch to the primary science orbit, 2007 IEEE

- Aerospace Conference, Inst. of ELec. and Elec. Eng. Computer Society, IEEE, March 3-10, 2007, 1-19. doi:10.1109/AERO.2007.352746.
- Kahn, Ralph, 1984, The spatial and seasonal distribution of Martian clouds and some meteorological implications, *Journal of Geophysical Research: Space Physics* 89, A8, 6671-6688.
- Kahre, MA, JL Hollingsworth, RM Haberle, and RJ Wilson, 2015, Coupling the Mars dust and water cycles: the importance of radiative-dynamic feedbacks during northern hemisphere summer, *Icarus* 260, 477-480.
- Kleinböhl, A, JT Schofield, DM Kass, and DJ McCleese, 2016, The Advanced Mars Climate Sounder (AMCS)-A Proven Atmospheric Profiler for Future Mars Orbiters, 3rd International Workshop on Instrumentation for Planetary Missions, Pasadena, CA, October 24-27, 2016, 1980, 4066. <https://www.hou.usra.edu/meetings/ipm2016/pdf/4066.pdf>.
- Kleinböhl, Armin, JT Schofield, DM Kass, S Piqueux, DJ McCleese, A Spiga, SJ Greybush, and T Navarro, 2018, Mars Weather and Climate: An Orbital Constellation for Atmospheric Profiling and Surface Thermophysics. https://mepag.jpl.nasa.gov/meeting/2018-04/EPosters/15_Kleinbohl_mars_weather_climate_mepag_180419.pdf.
- Kleinböhl, Armin, John T Schofield, David M Kass, Wedad A Abdou, Charles R Backus, Bhaswar Sen, James H Shirley, W Gregory Lawson, Mark I Richardson, and Fredric W Taylor, 2009, Mars Climate Sounder limb profile retrieval of atmospheric temperature, pressure, and dust and water ice opacity, *Journal of Geophysical Research: Planets* 114, E10. doi:10.1029/2009JE003358.
- Kleinböhl, Armin, Aymeric Spiga, David M Kass, James H Shirley, Ehouarn Millour, Luca Montabone, and Francois Forget, 2020, Diurnal variations of dust during the 2018 global dust storm observed by the Mars Climate Sounder, *Journal of Geophysical Research: Planets* 125, 1, e2019JE006115.
- Korablev, Oleg, Franck Montmessin, A Trokhimovskiy, Anna A Fedorova, AV Shakun, AV Grigoriev, BE Moshkin, NI Ignatiev, François Forget, and Franck Lefèvre, 2018, The atmospheric chemistry suite (ACS) of three spectrometers for the ExoMars 2016 Trace Gas Orbiter, *Space Science Reviews* 214, 1, 7. doi:10.1007/s11214-017-0437-6.
- Kulowski, Laura, Huiqun Wang, and Anthony D Toigo, 2017, The seasonal and spatial distribution of textured dust storms observed by Mars Global Surveyor Mars Orbiter Camera, *Advances in Space Research* 59, 2, 715-721.
- Kuramoto, Kiyoshi, Yasuhiro Kawakatsu, and Masayuki Fujimoto, 2018, Martian Moons eXploration (MMX): an overview of its science, EPSC, EPSC2018-1036.
- Lanzerotti, Louis J, 2013, Van allen probes mission, *Space Weather* 11, 4, 133-133.
- Leblanc, François, Ronan Modolo, Shannon Curry, Janet Luhmann, Rob Lillis, Jean-Yves Chaufray, Takuya Hara, Jim Mcfadden, Jasper Halekas, and Frank Eparvier, 2015, Mars heavy ion precipitating flux as measured by Mars Atmosphere and Volatile Evolution, *Geophysical Research Letters* 42, 21, 9135-9141. doi:10.1002/2015GL066170.
- Lewis, SR, and PR Barker, 2005, Atmospheric tides in a Mars general circulation model with data assimilation, *Advances in Space Research* 36, 11, 2162-2168.
- Lillis, R, M Curry, J Parker, and D Curtis, 2019, ESCAPADE: the Escape and Plasma Acceleration and Dynamics Explorers, Planetary CubeSats Symposium, NASA Goddard Space Flight Center, Greenbelt, MD, June 27-28, 2019.
- Lillis, Robert J, Justin Deighan, Jane L Fox, Stephen W Bougher, Yuni Lee, Michael R Combi, Thomas E Cravens, Ali Rahmati, Paul R Mahaffy, and Mehdi Benna, 2017, Photochemical escape of oxygen from Mars: First results from MAVEN in situ data, *Journal of Geophysical Research: Space Physics* 122, 3, 3815-3836.

- Lillis, Robert J, David L Mitchell, Morgane Steckiewicz, David Brain, Shaosui Xu, Tristan Weber, Jasper Halekas, Jack Connerney, Jared Espley, and Mehdi Benna, 2018, Ionizing electrons on the Martian nightside: Structure and variability, *Journal of Geophysical Research: Space Physics* 123, 5, 4349-4363.
- Liu, Guiping, Scott England, Robert J Lillis, Paul R Mahaffy, Meredith Elrod, Mehdi Benna, and Bruce Jakosky, 2017, Longitudinal structures in Mars' upper atmosphere as observed by MAVEN/NGIMS, *Journal of Geophysical Research: Space Physics* 122, 1, 1258-1268.
- Lock, Robert E, Peter Xaypraseuth, M Daniel Johnston, C Allen Halsell, Angela L Bowes, Daniel T Lyons, Tung-Han You, Dolan E Highsmith, and Moriba Jah, 2004, The Mars reconnaissance orbiter mission plan, AAS/AIAA Space Flight Mechanics Meeting, February 8-12, 2004, 119, 2629-2647.
- Long, Stacia, Dan Lyons, Joe Guinn, and Rob, 2012, ExoMars/TGO Science Orbit Design, AIAA/AAS Astrodynamics Specialist Conference, August 13-16, 2012, 4881. doi:10.2514/6.2012-4881.
- Ma, YJ, X Fang, AF Nagy, CT Russell, and Gabor Toth, 2014, Martian ionospheric responses to dynamic pressure enhancements in the solar wind, *Journal of Geophysical Research: Space Physics* 119, 2, 1272-1286. doi:10.1002/2013JA019402.
- Madeleine, J-B, François Forget, E Millour, T Navarro, and Aymeric Spiga, 2012, The influence of radiatively active water ice clouds on the Martian climate, *Geophysical Research Letters* 39, 23.
- Mahaffy, Paul R, Mehdi Benna, M Elrod, Roger V Yelle, Stephen W Bougher, Shane Wesley Stone, and Bruce Martin Jakosky, 2015, Structure and composition of the neutral upper atmosphere of Mars from the MAVEN NGIMS investigation, *Geophysical research letters* 42, 21, 8951-8957.
- Mahaffy, Paul R, Mehdi Benna, Todd King, Daniel N Harpold, Robert Arvey, Michael Barciniak, Mirl Bendt, Daniel Carrigan, Therese Errigo, and Vincent Holmes, 2015, The neutral gas and ion mass spectrometer on the Mars atmosphere and volatile evolution mission, *Space Science Reviews* 195, 1-4, 49-73.
- Malana, Daniël F, Adrien Palunb, Bryan Deana, Jeroen Rotteveelb, and Duncan Stanton, 2018, Scalable CubeSat Earth Observation payloads, born from international collaboration, 69th International Astronautical Congress (IAC), Bremen, Germany, October 1-5, 2018.
- Malin, Michael C, Wendy M Calvin, Bruce A Cantor, R Todd Clancy, Robert M Haberle, Philip B James, Peter C Thomas, Michael J Wolff, James F Bell III, and Steven W Lee, 2008, Climate, weather, and north polar observations from the Mars Reconnaissance Orbiter Mars Color Imager, *Icarus* 194, 2, 501-512.
- Malin, Michael C, Michael A Caplinger, and Scott D Davis, 2001, Observational evidence for an active surface reservoir of solid carbon dioxide on Mars, *Science* 294, 5549, 2146-2148.
- Marquette, Melissa L, Robert J Lillis, JS Halekas, JG Luhmann, JR Gruesbeck, and JR Espley, 2018, Autocorrelation study of solar wind plasma and IMF properties as measured by the MAVEN spacecraft, *Journal of Geophysical Research: Space Physics* 123, 4, 2493-2512.
- Mayyasi, Majd, Dolon Bhattacharyya, John Clarke, Amy Catalano, Mehdi Benna, Paul Mahaffy, Edward Thiemann, Christina O Lee, Justin Deighan, and Sonal Jain, 2018, Significant space weather impact on the escape of hydrogen from Mars, *Geophysical Research Letters* 45, 17, 8844-8852.
- McCleese, DJ, NG Heavens, JT Schofield, WA Abdou, JL Bandfield, SB Calcutt, PGJ Irwin, DM Kass, A Kleinböhl, and SR Lewis, 2010, Structure and dynamics of the Martian lower and middle atmosphere as observed by the Mars Climate Sounder: Seasonal variations in zonal mean temperature, dust, and water ice aerosols, *Journal of Geophysical Research: Planets* 115, E12.

- McCleese, DJ, JT Schofield, FW Taylor, SB Calcutt, MC Foote, DM Kass, CB Leovy, DA Paige, PL Read, and RW Zurek, 2007, Mars Climate Sounder: An investigation of thermal and water vapor structure, dust and condensate distributions in the atmosphere, and energy balance of the polar regions, *Journal of Geophysical Research: Planets* 112, E5.
doi:10.1029/2006JE002790.
- McClintock, William E, Nicholas M Schneider, Gregory M Holsclaw, John T Clarke, Alan C Hoskins, Ian Stewart, Franck Montmessin, Roger V Yelle, and Justin Deighan, 2015, The imaging ultraviolet spectrograph (IUVS) for the MAVEN mission, *Space Science Reviews* 195, 1-4, 75-124. doi:10.1007/s11214-014-0098-7.
- Mellon, Michael T, and Bruce M Jakosky, 1993, Geographic variations in the thermal and diffusive stability of ground ice on Mars, *Journal of Geophysical Research: Planets* 98, E2, 3345-3364.
- Mellon, Michael T, Bruce M Jakosky, and Susan E Postawko, 1997, The persistence of equatorial ground ice on Mars, *Journal of Geophysical Research: Planets* 102, E8, 19357-19369.
- Mendillo, Michael, Xiaoqing Pi, Steven Smith, Carlos Martinis, Jody Wilson, and David Hinson, 2004, Ionospheric effects upon a satellite navigation system at Mars, *Radio Science* 39, 2, 1-11.
- MEPAG, 2015, Report from the Next Orbiter Science Analysis Group (NEX-SAG), Edited by B Campbell and R Zurek. https://mepag.jpl.nasa.gov/reports/NEX-SAG_draft_v29_FINAL.pdf.
- MEPAG, 2018, Goals Committee (Mars Exploration Program Analysis Group). Mars Science Goals, Objectives, Investigations, and Priorities: 2018 version, Edited by D. Banfield et al. 81. https://mepag.jpl.nasa.gov/reports/MEPAG%20Goals_Document_2018.pdf.
- MEPAG, 2019, Report from the Ice and Climate Evolution Science Analysis group (ICE-SAG), Edited by S Diniega and N E Putzig. https://mepag.jpl.nasa.gov/reports/Preprint_ICESAG_May28.pdf.
- Mhangara, Paidamwoyo, Willard Mapurisa, and Naledzani Mudau, 2020, Image Interpretability of nSight-1 Nanosatellite Imagery for Remote Sensing Applications, *Aerospace* 7, 2, 19.
doi:10.3390/aerospace7020019.
- Modolo, Ronan, Gérard M Chanteur, and Eduard Dubinin, 2012, Dynamic Martian magnetosphere: Transient twist induced by a rotation of the IMF, *Geophysical Research Letters* 39, 1.
doi:10.1029/2011gl049895.
- Montabone, L, F Forget, E Millour, RJ Wilson, SR Lewis, B Cantor, D Kass, A Kleinböhl, MT Lemmon, and MD Smith, 2015, Eight-year climatology of dust optical depth on Mars, *Icarus* 251, 65-95.
- Montabone, Luca, Stephen R Lewis, and Peter L Read, 2005, Interannual variability of Martian dust storms in assimilation of several years of Mars global surveyor observations, *Advances in Space Research* 36, 11, 2146-2155.
- Mulholland, David P, Stephen R Lewis, Peter L Read, Jean-Baptiste Madeleine, and Francois Forget, 2016, The solsticial pause on Mars: 2 modelling and investigation of causes, *Icarus* 264, 465-477.
- National Research Council, Division on Engineering and Physical Sciences, Space Studies Board, Committee on the Planetary Science Decadal Survey, 2011, *Vision and Voyages: For Planetary Science in the Decade 2013-2022*, National Academies Press, Washington, DC.
- Navarro, Thomas, J-B Madeleine, François Forget, Aymeric Spiga, Ehouarn Millour, Franck Montmessin, and Anni Määttänen, 2014, Global climate modeling of the Martian water cycle with improved microphysics and radiatively active water ice clouds, *Journal of Geophysical Research: Planets* 119, 7, 1479-1495.
- Neary, Lori, F Daerden, S Aoki, J Whiteway, RT Clancy, M Smith, S Viscardy, JT Erwin, IR Thomas, and G Villanueva, 2020, Explanation for the increase in high-altitude water on Mars observed

- by NOMAD during the 2018 global dust storm, *Geophysical Research Letters* 47, 7, e2019GL084354.
- Newman, Claire E, Javier Gómez-Elvira, Mercedes Marin, Sara Navarro, Josefina Torres, Mark I Richardson, J Michael Battalio, Scott D Guzewich, Robert Sullivan, and Manuel de la Torre, 2017, Winds measured by the Rover Environmental Monitoring Station (REMS) during the Mars Science Laboratory (MSL) rover's Bagnold Dunes Campaign and comparison with numerical modeling using MarsWRF, *Icarus* 291, 203-231.
- Newman, Claire E, Stephen R Lewis, Peter L Read, and François Forget, 2002, Modeling the Martian dust cycle 2. Multiannual radiatively active dust transport simulations, *Journal of Geophysical Research: Planets* 107, E12, 7-1-7-15.
- Newman, Claire E, and Mark I Richardson, 2015, The impact of surface dust source exhaustion on the martian dust cycle, dust storms and interannual variability, as simulated by the MarsWRF General Circulation Model, *Icarus* 257, 47-87.
- Nilsson, Hans, Ella Carlsson, David A Brain, Masatoshi Yamauchi, Mats Holmström, Stas Barabash, Rickard Lundin, and Yoshifumi Futaana, 2010, Ion escape from Mars as a function of solar wind conditions: A statistical study, *Icarus* 206, 1, 40-49. doi:10.1016/j.icarus.2009.03.006.
- Parker, Jeffrey S, Omar Hussain, Nathan Parrish, and Nathan Loucks, 2017, Mission design for the emirates mars mission, AAS/AIAA Astrodynamics Specialist Conference, August 20-24, 2017.
- Parker, Jeffrey S, Nathan Parrish, Rob Lillis, Shannon Curry, Dave Curtis, Janet Luhmann, Jordi Puig-Suari, Christopher Russell, and David Brain, 2018, Mars ion and sputtering escape network (MISEN) mission concept, AAS/AIAA Astrodynamics Specialist Conference, August 19-23, 2018.
- Paschmann, Götz, and Patrick W Daly, 1998, Analysis methods for multi-spacecraft data. issi scientific reports series sr-001, esa/issi, vol. 1. isbn 1608-280x, 1998, ISSIR 1.
- Petersen, Eric Ivan, John W Holt, and Joseph S Levy, 2018, High ice purity of Martian lobate debris aprons at the regional scale: evidence from an orbital radar sounding survey in Deuteronilus and Protonilus Mensae, *Geophysical Research Letters* 45, 21, 11,595-11,604.
- Phillips, Roger J, Maria T Zuber, Suzanne E Smrekar, Michael T Mellon, James W Head, Kenneth L Tanaka, Nathaniel E Putzig, Sarah M Milkovich, Bruce A Campbell, and Jeffrey J Plaut, 2008, Mars north polar deposits: Stratigraphy, age, and geodynamical response, *Science* 320, 5880, 1182-1185.
- Piqueux, Sylvain, Armin Kleinböhl, Paul O Hayne, Nicholas G Heavens, David M Kass, Daniel J McCleese, John T Schofield, and James H Shirley, 2016, Discovery of a widespread low-latitude diurnal CO₂ frost cycle on Mars, *Journal of Geophysical Research: Planets* 121, 7, 1174-1189. doi:10.1002/2016JE005034.
- Plaut, Jeffrey J, Giovanni Picardi, Ali Safaeinili, Anton B Ivanov, Sarah M Milkovich, Andrea Cicchetti, Wlodek Kofman, Jérémie Mouginot, William M Farrell, and Roger J Phillips, 2007, Subsurface radar sounding of the south polar layered deposits of Mars, *science* 316, 5821, 92-95.
- Potter, Robert, Ryan Woolley, Austin Nicholas, and James Longuski, 2017, Features and characteristics of earth-mars bacon plots, AAS/AIAA Astrodynamics Specialist Conference, August 20-24, 2017.
- Rafkin, Scot CR, 2009, A positive radiative-dynamic feedback mechanism for the maintenance and growth of Martian dust storms, *Journal of Geophysical Research: Planets* 114, E1.
- Rafkin, Scot CR, 2012, The potential importance of non-local, deep transport on the energetics, momentum, chemistry, and aerosol distributions in the atmospheres of Earth, Mars, and Titan, *Planetary and Space Science* 60, 1, 147-154.

- Rafkin, Scot CR, Magdalena RV Sta Maria, and Timothy I Michaels, 2002, Simulation of the atmospheric thermal circulation of a martian volcano using a mesoscale numerical model, *Nature* 419, 6908, 697-699.
- Read, PL, SR Lewis, and DP Mulholland, 2015, The physics of Martian weather and climate: a review, *Reports on Progress in Physics* 78, 12, 125901.
- Rennó, Nilton O, Brent J Bos, David Catling, Benton C Clark, Line Drube, David Fisher, Walter Goetz, Stubbe F Hviid, Horst Uwe Keller, and Jasper F Kok, 2009, Possible physical and thermodynamical evidence for liquid water at the Phoenix landing site, *Journal of Geophysical Research: Planets* 114, E1.
- Ritter, Birgit, J-C Gérard, Benoît Hubert, L Rodriguez, and Franck Montmessin, 2018, Observations of the proton aurora on Mars with SPICAM on board Mars Express, *Geophysical Research Letters* 45, 2, 612-619.
- Roeten, Kali J, Stephen W Bougher, Mehdi Benna, Paul R Mahaffy, Yuni Lee, Dave Pawlowski, Francisco González-Galindo, and Miguel Ángel López-Valverde, 2019, MAVEN/NGIMS Thermospheric Neutral Wind Observations: Interpretation Using the M-GITM General Circulation Model, *Journal of Geophysical Research: Planets* 124, 12, 3283-3303.
- Romanelli, Norberto, Christian Mazelle, Jean-Yves Chaufray, Karim Meziane, Lican Shan, Suranga Ruhunusiri, Jack EP Connerney, Jared R Espley, Francis Eparvier, and E Thiemann, 2016, Proton cyclotron waves occurrence rate upstream from Mars observed by MAVEN: Associated variability of the Martian upper atmosphere, *Journal of Geophysical Research: Space Physics* 121, 11, 11,113-11,128.
- Romero, P, B Pablos, and G Barderas, 2017, Analysis of orbit determination from Earth-based tracking for relay satellites in a perturbed areostationary orbit, *Acta Astronautica* 136, 434-442. doi:10.1016/j.actaastro.2017.04.002.
- Ruhunusiri, Suranga, JS Halekas, JEP Connerney, JR Espley, JP McFadden, C Mazelle, D Brain, G Collinson, Y Harada, and DE Larson, 2016, MAVEN observation of an obliquely propagating low-frequency wave upstream of Mars, *Journal of Geophysical Research: Space Physics* 121, 3, 2374-2389. doi:10.1002/2015ja022306.
- Ruhunusiri, Suranga, JS Halekas, JR Espley, C Mazelle, D Brain, Y Harada, GA DiBraccio, R Livi, DE Larson, and DL Mitchell, 2017, Characterization of turbulence in the Mars plasma environment with MAVEN observations, *Journal of Geophysical Research: Space Physics* 122, 1, 656-674. doi:10.1002/2016JA023456.
- Saleh, Joseph Homer, Fan Geng, Michelle Ku, and Mitchell LR Walker II, 2017, Electric propulsion reliability: Statistical analysis of on-orbit anomalies and comparative analysis of electric versus chemical propulsion failure rates, *Acta Astronautica* 139, 141-156.
- Shaposhnikov, Dmitry S, Alexander S Medvedev, Alexander V Rodin, and Paul Hartogh, 2019, Seasonal water “pump” in the atmosphere of Mars: Vertical transport to the thermosphere, *Geophysical Research Letters* 46, 8, 4161-4169.
- Shepherd, Gordon G, Gérard Thuillier, Y-M Cho, M-L Duboin, Wayne FJ Evans, WA Gault, Charles Hersom, DJW Kendall, Chantal Lathuillere, and RP Lowe, 2012, The wind imaging interferometer (WINDII) on the upper atmosphere research satellite: a 20 year perspective, *Reviews of Geophysics* 50, 2. doi:10.1029/2012RG000390.
- Siu, Nathan O, and Dana L Kelly, 1998, Bayesian parameter estimation in probabilistic risk assessment, *Reliability Engineering & System Safety* 62, 1-2, 89-116.
- Smoluchowski, R, 1968, Mars: Retention of ice, *Science* 159, 3821, 1348-1350.
- Solomon, Sean C, and James W Head, 1990, Heterogeneities in the thickness of the elastic lithosphere of Mars: Constraints on heat flow and internal dynamics, *Journal of Geophysical Research: Solid Earth* 95, B7, 11073-11083.

- Spiga, Aymeric, Julien Faure, Jean-Baptiste Madeleine, Anni Määttä, and François Forget, 2013, Rocket dust storms and detached dust layers in the Martian atmosphere, *Journal of Geophysical Research: Planets* 118, 4, 746-767.
- Spiga, Aymeric, David P Hinson, Jean-Baptiste Madeleine, Thomas Navarro, Ehouarn Millour, François Forget, and Franck Montmessin, 2017, Snow precipitation on Mars driven by cloud-induced night-time convection, *Nature Geoscience* 10, 9, 652-657.
- Steele, Liam J, Stephen R Lewis, Manish R Patel, Franck Montmessin, François Forget, and Michael D Smith, 2014, The seasonal cycle of water vapour on Mars from assimilation of Thermal Emission Spectrometer data, *Icarus* 237, 97-115.
- Stillman, David E, and Robert E Grimm, 2011, Radar penetrates only the youngest geological units on Mars, *Journal of Geophysical Research: Planets* 116, E3.
- Stuurman, CM, GR Osinski, JW Holt, JS Levy, TC Brothers, M Kerrigan, and BA Campbell, 2016, SHARAD detection and characterization of subsurface water ice deposits in Utopia Planitia, Mars, *Geophysical Research Letters* 43, 18, 9484-9491.
- Suzuki, Takeru K, 2013, Evolution of solar-type stellar winds, *Astronomische Nachrichten* 334, 1-2, 81-84. doi:10.1002/asna.201211751.
- Toigo, AD, DW Waugh, and SD Guzewich, 2017, What causes Mars' annular polar vortices?, *Geophysical Research Letters* 44, 1, 71-78.
- Toigo, Anthony D, Michael D Smith, Frank P Seelos, and Scott L Murchie, 2013, High spatial and temporal resolution sampling of Martian gas abundances from CRISM spectra, *Journal of Geophysical Research: Planets* 118, 1, 89-104. doi:10.1029/2012JE004147.
- Vandaele, Ann Carine, Oleg Koroblev, Frank Daerden, Shohei Aoki, Ian R Thomas, Francesca Altieri, Miguel López-Valverde, Geronimo Villanueva, Giuliano Liuzzi, and Michael D Smith, 2019, Martian dust storm impact on atmospheric H₂O and D/H observed by ExoMars Trace Gas Orbiter, *Nature* 568, 7753, 521-525.
- Vandaele, Ann Carine, J-J Lopez-Moreno, Manish R Patel, G Bellucci, F Daerden, B Ristic, Séverine Robert, IR Thomas, Valérie Wilquet, and M Allen, 2018, NOMAD, an integrated suite of three spectrometers for the ExoMars Trace Gas mission: technical description, science objectives and expected performance, *Space Science Reviews* 214, 5, 80. doi:10.1007/s11214-018-0517-2.
- Vogt, Marissa F, Paul Withers, Kathryn Fallows, Laila Andersson, Zachary Girazian, Paul R Mahaffy, Mehdi Benna, Meredith K Elrod, John EP Connerney, and Jared R Espley, 2017, MAVEN observations of dayside peak electron densities in the ionosphere of Mars, *Journal of Geophysical Research: Space Physics* 122, 1, 891-906.
- Wang, Chao, François Forget, Tanguy Bertrand, Aymeric Spiga, Ehouarn Millour, and Thomas Navarro, 2018, Parameterization of rocket dust storms on Mars in the LMD Martian GCM: modeling details and validation, *Journal of Geophysical Research: Planets* 123, 4, 982-1000.
- Wang, Huiqun, and Jenny A Fisher, 2009, North polar frontal clouds and dust storms on Mars during spring and summer, *Icarus* 204, 1, 103-113.
- Waters, Joe W, Lucien Froidevaux, Robert S Harwood, Robert F Jarnot, Herbert M Pickett, William G Read, Peter H Siegel, Richard E Cofield, Mark J Filipiak, and Dennis A Flower, 2006, The earth observing system microwave limb sounder (EOS MLS) on the Aura satellite, *IEEE Transactions on Geoscience and Remote Sensing* 44, 5, 1075-1092. doi:10.1109/TGRS.2006.873771.
- Weiss, David K, and James W Head, 2017, Evidence for stabilization of the ice-cemented cryosphere in earlier Martian history: Implications for the current abundance of groundwater at depth on Mars, *Icarus* 288, 120-147.
- Wenkert, Daniel, Nathan Bridges, William Eggemeyer, Amy Hale, Terry Martin, Stephen Noland, David Kass, Ali Safaeinili, and Suzanne Smrekar, 2006, Science Planning for the NASA Mars

- Reconnaissance Orbiter Mission, SpaceOps 2006 Conference, 9th International Conference on Space Operations, June 19-23, 2006, 5856.
- Wikipedia. "Atlas V." accessed June 9, 2020. https://en.wikipedia.org/wiki/Atlas_V
- Wikipedia. "Bayesian Inference (Beta distribution)." accessed June 20, 2020. https://en.wikipedia.org/wiki/Beta_distribution#Bayesian_inference.
- Wikipedia. "Dawn (spacecraft)." accessed June 13, 2020. [https://en.wikipedia.org/wiki/Dawn_\(spacecraft\)](https://en.wikipedia.org/wiki/Dawn_(spacecraft)).
- Wikipedia. "Delta IV Heavy." accessed June 9, 2020. https://en.wikipedia.org/wiki/Delta_IV_Heavy.
- Wikipedia. "Falcon 9." accessed June 9, 2020. https://en.wikipedia.org/wiki/Falcon_9.
- Wilson, RJ, RM Haberle, J Noble, AFC Bridger, J Schaeffer, JR Barnes, and BA Cantor, 2008, Simulation of the 2001 planet-encircling dust storm with the NASA/NOAA Mars general circulation model, LPICo 1447, 9023. <http://www.lpi.usra.edu/meetings/modeling2008/pdf/9023.pdf>.
- Wilson, R John, and Scott D Guzewich, 2014, Influence of water ice clouds on nighttime tropical temperature structure as seen by the Mars Climate Sounder, *Geophysical Research Letters* 41, 10, 3375-3381.
- Wilson, R John, Stephen R Lewis, Luca Montabone, and Michael D Smith, 2008, Influence of water ice clouds on Martian tropical atmospheric temperatures, *Geophysical Research Letters* 35, 7.
- Wilson, R John, Gregory A Neumann, and Michael D Smith, 2007, Diurnal variation and radiative influence of Martian water ice clouds, *Geophysical Research Letters* 34, 2.
- Wolff, Michael J, MIGUEL López-Valverde, JEAN-BAPTISTE Madeleine, R JOHN Wilson, MD Smith, T Fouchet, and GT Delory, 2017, Radiative process: Techniques and applications, *The atmosphere and climate of Mars* 18, 106.
- Woolley, R. C., F. Laipert, A. K. Nicholas, and Z. P. Olikara, 2019, Low-Thrust Trajectory Bacon Plots for Mars Mission Design, AAS 19-326AAS/AIAA Spaceflight Mechanics Meeting, Maui, HI, January 2019.
- Woolley, Ryan C, and Austin K Nicholas, 2015, SEP mission design space for Mars orbiters, AAS/AIAA Astrodynamics Specialist Conference, August 9-13, 2015.
- Wu, Zhaopeng, Tao Li, Xi Zhang, Jing Li, and Jun Cui, 2020, Dust tides and rapid meridional motions in the Martian atmosphere during major dust storms, *Nature Communications* 11, 1, 1-10.
- Xu, Shaosui, David Mitchell, Michael Liemohn, Xiaohua Fang, Yingjuan Ma, Janet Luhmann, David Brain, Morgane Steckiewicz, Christian Mazelle, and Jack Connerney, 2017, Martian low-altitude magnetic topology deduced from MAVEN/SWEA observations, *Journal of Geophysical Research: Space Physics* 122, 2, 1831-1852. doi:10.1002/2016JA023467.
- Xu, Shaosui, David L Mitchell, James P McFadden, Glyn Collinson, Yuki Harada, Robert Lillis, Christian Mazelle, and JEP Connerney, 2018, Field-aligned potentials at Mars from MAVEN observations, *Geophysical Research Letters* 45, 19, 10,119-10,127.
- Yiğit, Erdal, Scott L England, Guiping Liu, Alexander S Medvedev, Paul R Mahaffy, Takeshi Kuroda, and Bruce M Jakosky, 2015, High-altitude gravity waves in the Martian thermosphere observed by MAVEN/NGIMS and modeled by a gravity wave scheme, *Geophysical Research Letters* 42, 21, 8993-9000.
- Yozallinas, J., 2019, Failure Modes, Effects and Diagnostic Analysis, ROS 13/06-005 R001, 2, 0.
- Zeitlin, C, T Cleghorn, F Cucinotta, P Saganti, V Andersen, K Lee, L Pinsky, W Atwell, R Turner, and G Badhwar, 2004, Overview of the Martian radiation environment experiment, *Advances in Space Research* 33, 12, 2204-2210.