

National Aeronautics and
Space Administration

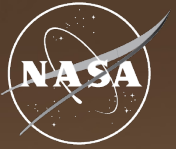

NASA/ESA
**MARS
SAMPLE
RETURN**

Mars Sample Return (MSR) Program

Planetary Advisory Committee
June 21, 2023

Jeff Gramling, Program Director
Michael Meyer, Mars Lead Scientist
Richard Cook, Program Manager (JPL)

The decision to implement Mars Sample Return will not be finalized until NASA's completion of the National Environmental Policy Act (NEPA) process. This presentation is being made available for information purposes only.

The Value of Mars Sample Return to National Goals

“The highest scientific priority of NASA’s robotic exploration efforts this decade should be completion of Mars Sample Return as soon as is practicably possible with no increase or decrease in its current scope”

Origins, Worlds, and Life- A Decadal Strategy for Planetary Science and Astrobiology 2023-2032

- MSR is our best near-term opportunity to answer the question “Are we alone in the universe?”
 - Mars may have the best record of the first billion years of planetary evolution and life’s beginning in the Solar System
- Discovery science - the returned samples will be analyzed in laboratories at universities/research institutes across the world, for decades to come
- The capabilities demonstrated and science returned by the first sample return from another planet will ensure American leadership and pave the way for eventual human exploration of Mars
- What we learn from the samples can significantly retire planetary protection concerns and reduce the costs of future Mars missions

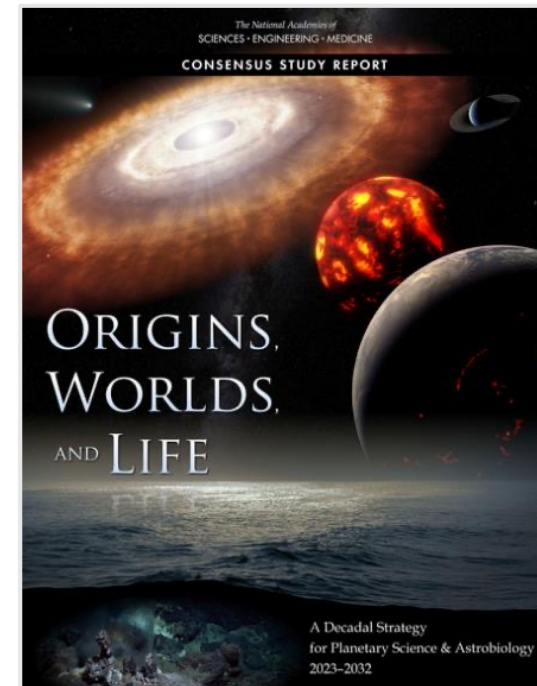



Current Status

- The Perseverance rover has selected and created a surface cache of scientifically-selected samples
- Project Preliminary Design Reviews (PDRs) in progress:
 - Capture, Containment, & Return System (CCRS) PDR Part 1 - Dec 2022
 - Mars Ascent Vehicle (MAV) PDR - April 2023
 - Sample Retrieval Lander (SRL) PDR - May 2023
 - CCRS PDR Part 2, TBD
- The MAV first and second stage solid rocket Development Motor-1 hot fire tests completed in April. Preliminary test results indicate that the thrust vector control supersonic splitline (SSSL) achieved TRL-6 (only technology readiness item for the Program). Final TRL-6 test report to be released by early August
- Sample Tubes contained in a test article undergoing Earth impact drop testing via tower at JPL; tests how the tubes respond to insults received within the containment vessels (beyond levels already tested during M2020)
- Agency Confirmation to proceed into Implementation Phase following System-Level PDR
- Given the complexity and cost of a mission such as MSR, a second Independent Review Board has been commissioned prior to Confirmation (kick-off briefings held May 23-25)

Campaign Science Update

- The NASA /ESA MSR Campaign Science Group (MCSG) is concerned with Campaign science, including sample integrity planning, developing ground-based infrastructure, and science community engagement.
 - Led a Science Community Workshop in assessing the initial depot as return worthy. All seven of the iMOST objectives can be addressed by the samples in this depot.
 - The SRF Contamination Panel has been established to define terrestrial biological, organic and inorganic contamination limits for the samples from Mars during residence of the samples inside the SRF.
 - Rock and gas teams have assessed procedures to open the returned sample tubes to maximize the head gas extraction and minimize rock/regolith disruption. Reports concluding this summer.
- There is an open call for membership on the Measurement Definition Team (MDT) that will develop a strawman set of instruments that would be needed within the high-containment facility to accomplish sample safety assessment, curation, and science.
 - MDT Terms of Reference has been signed, June 14, 2023
 - Over 850 people have registered to receive the announcement of the MDT membership call
 - Letter of Applications due July 17, 2023
 - After selection, the MDT will be commissioned for approximately six months



Three Forks Cache Status Green highlights tubes cached at Three Forks

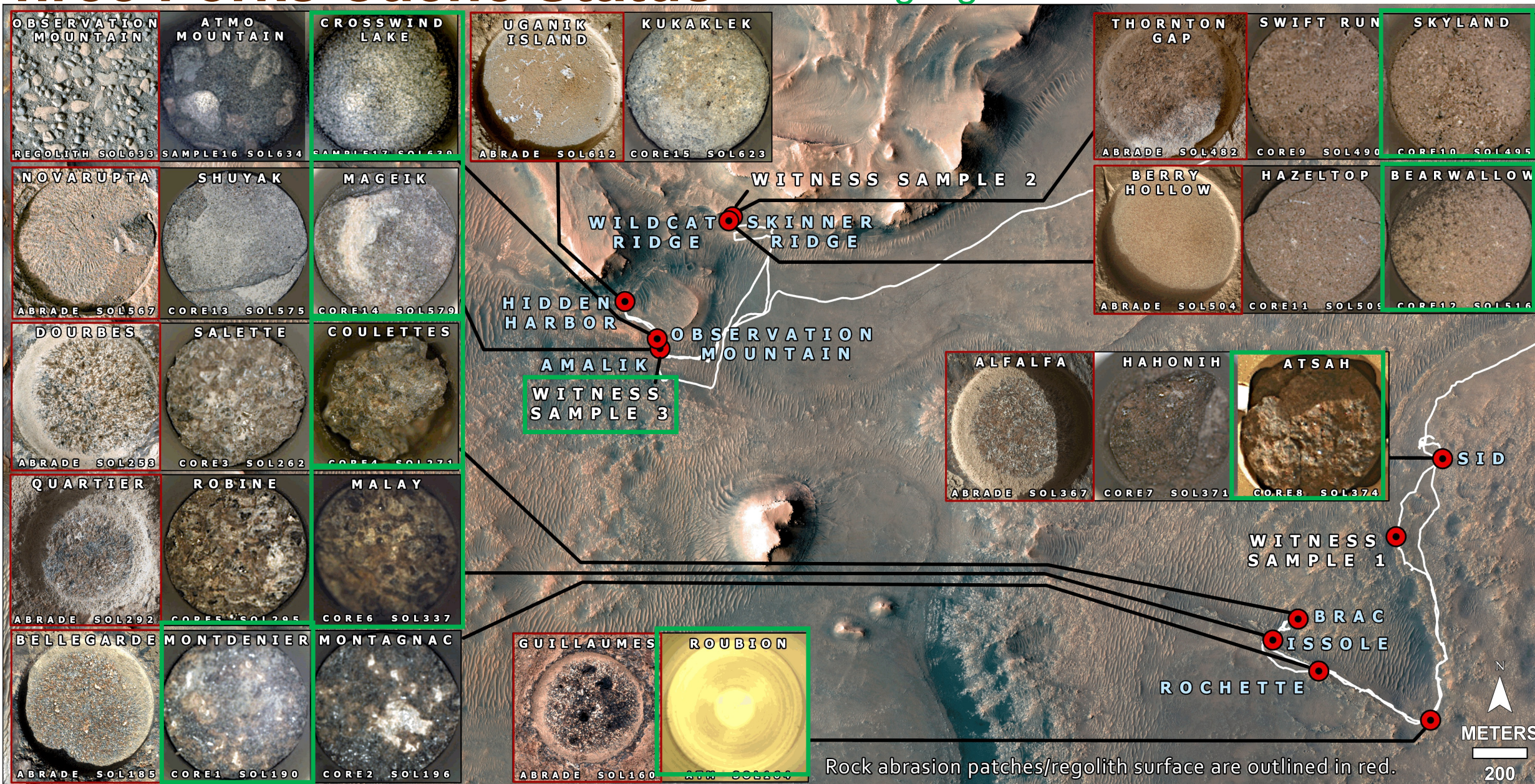

Rock abrasion patches/regolith surface are outlined in red.

Upper Fan Campaign (Sol 815): Tube 22+

- Sampling attempt at Ouzel Falls conglomerate not successful (rock very unconsolidated)
- Proceeding to investigate surrounding areas for potential next sampling attempts
- Critical event review will be conducted prior to leaving Jezero crater (~6 months)

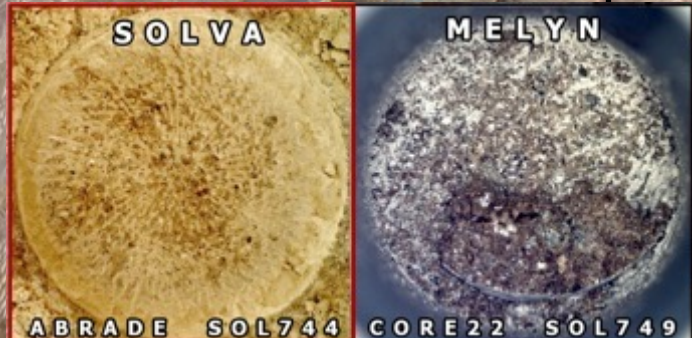
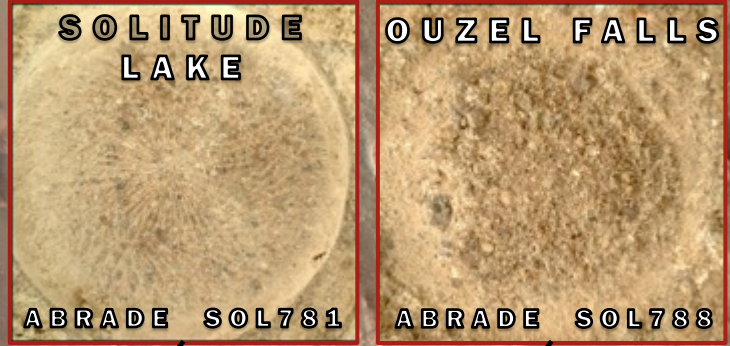

METERS
200

Backward Planetary Protection (BPP) Implementation

- MSR is the first mission to address challenging “break-the-chain” BPP requirement
- Employs redundancy for breaking the chain of contact with Mars
 - The system is tolerant to the failure of any one of three protective elements: a primary container, sterilization of the container exterior, and a secondary containment vessel
 - The samples (~500 g) collected by Perseverance would be further protected within hermetically sealed sample tubes, in addition to the primary and secondary containment vessels
- MSR approach to BPP to manage <40 mg of uncontained aeolian dust exterior to the Orbiting Sample (OS) container that:
 - Recognizes the very low potential hazard of subcellular entities to Earth’s biosphere
 - Uses an alternative sterilization process (UV) for cellular entities that reduces risk to sample integrity (vs. heat)
 - Less complex implementation should enhance reliability
- BPP approach is consistent with NASA and international BPP policies to achieve a very low risk of harm to Earth’s biosphere from sample return
- Independent review of this approach will be accomplished through:
 - 1) Independent panel review of MSR’s approach to subcellular entities and UV sterilization—commissioned by NASA Office of Chief Scientist
 - OCS study group is expected to release report summer 2023
 - 2) Testing of UV sterilization efficacy in CCRS environment
 - University of Florida independent testing of UV sterilization efficacy began June 2023

Backward Planetary Protection & Safe Operations With Mars Materials

Current MSR activities are:

- Building scientific consensus for assessing the safety of Martian dust on the Earth's biosphere
- Defining in-situ encapsulation and sterilization techniques
- Helping shape Governmental policy and process for future Mars returns

Returned samples (rock, regolith, dust & atmosphere) will be analyzed and evaluated for human safety





SRL Evolution

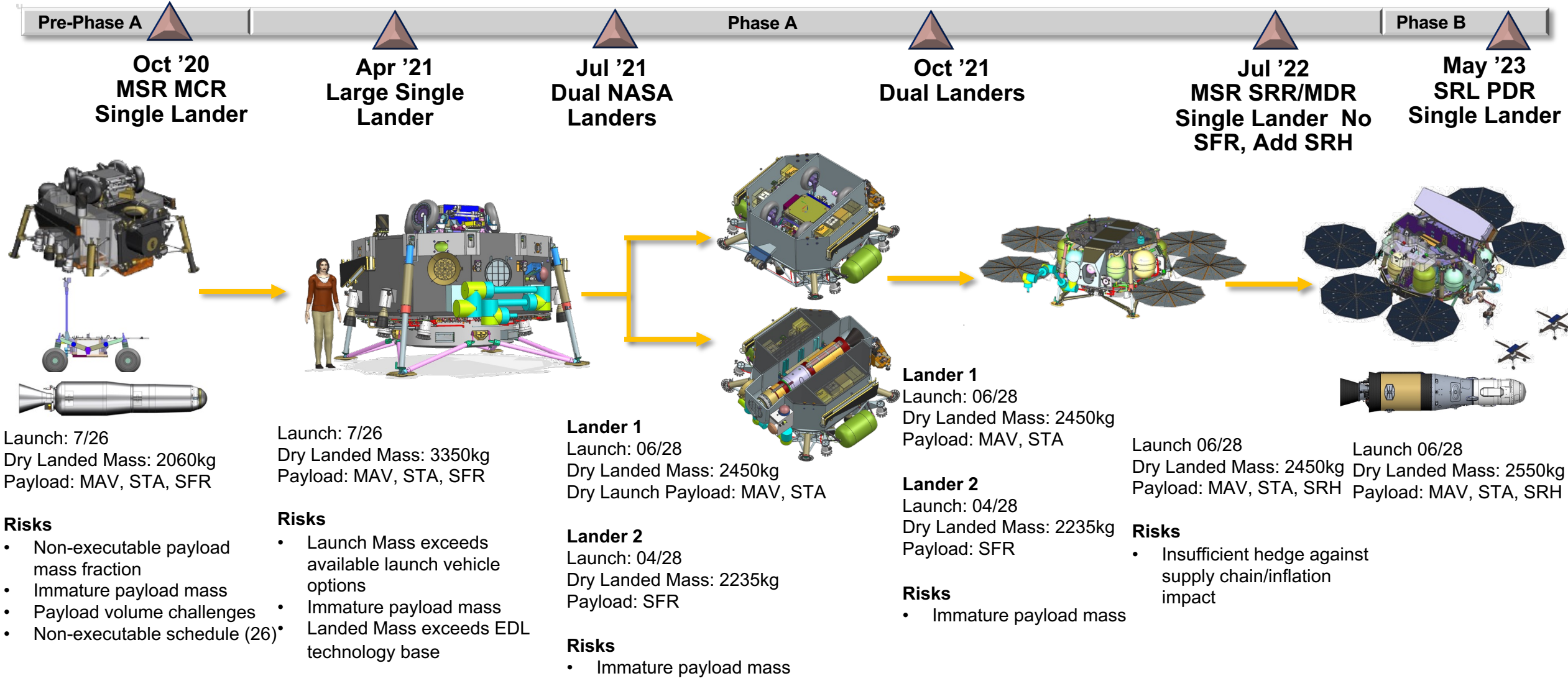



CCRS Evolution

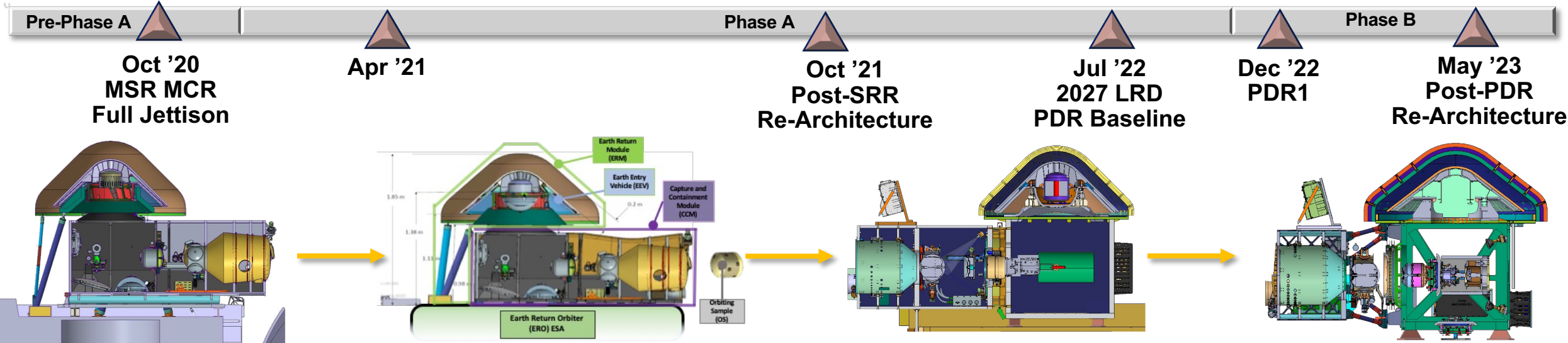

Risks

- Brazing technology
- Full jettison Architecture not viable
- Numerical containment assurance not viable

Addressed in New Design by:

- Different approach => Heated Shrink Fit (HSF)
- Partial jettison architecture

Risks

- Insufficient Robotic Assembly Force
- Numerical containment assurance not viable
- EES Mass Margin
- Kickstand I/F
- Mass Margin

Addressed in New Design by:

- Simplified robotics/containment configuration
- Subcellular descope/UV sterilization approach to BPP
- Dual containment/OS

Risks

- Kickstand I/F
- Shrink Fit/ATES Maturity
- Landing Impact Structural Margins
- Mass Margin

Addressed in New Design by:

- Removed kickstand I/F
- Removed ATES, now UV Syst.
- Deformable structure

Current Risks

- Mass Margin
- Subcellular descope/UV sterilization
- TPS Performance

Sample Recovery Helicopter (SRH)

- SRH was incorporated into the MSR campaign in mid-2022 replacing the ESA Sample Fetch Rover
 - Backup means for delivery of samples to the Lander
- SRH is derived from the successful Ingenuity technology demonstration on the M2020 mission
- Vacuum chamber testing of an engineering model completed end-February to demonstrate the SRH capability to retrieve samples cached on the surface by Perseverance
- Tested a range of parameters from within the design envelope (a combination of changes from Ingenuity heritage)
 - Design changes from Ingenuity include extension of rotor to 1.4m diameter, increased rotor speed, and higher angle of attack to support the 2.5kg mass requirement

Ingenuity-like rotorcraft with:

- Ground mobility
- Tube manipulator
- Stereo vision
- Inflight, absolute localization

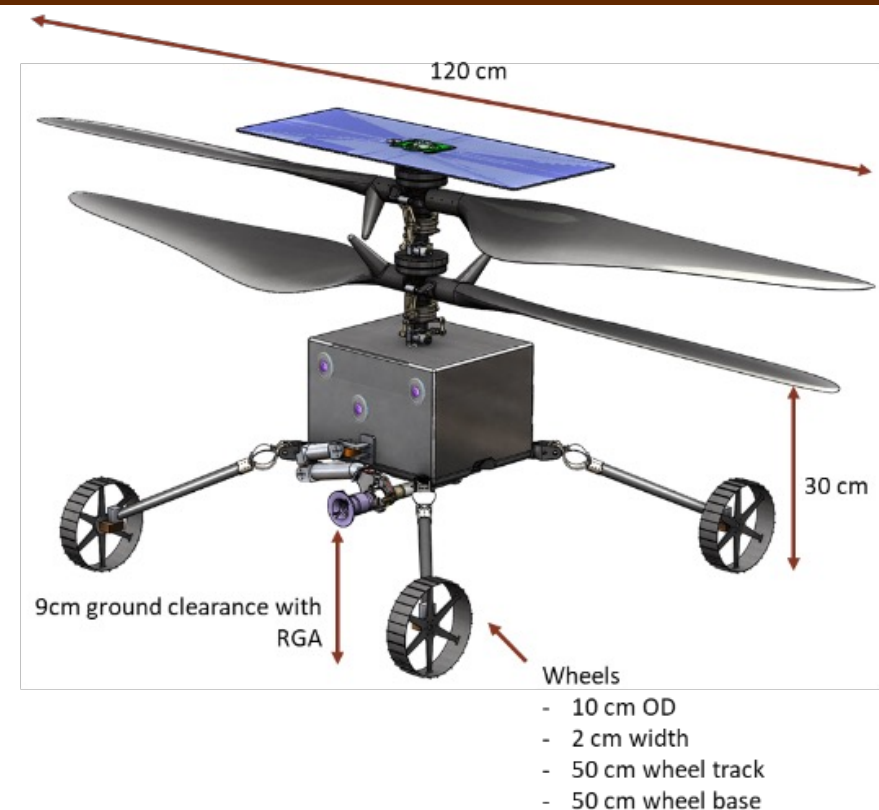

MAV Solid Rocket Motor Testing

- The MAV first and second stage solid rocket Development Motor-1 hot fire tests completed in April. Preliminary test results indicate that the thrust vector control supersonic splitline (SSSL) achieved TRL-6 (only technology readiness item for the Program)
 - The SSSL nozzle assembly provided expected thrust vectoring for the full duration of the motor burn
 - Post-test inspection and disassembly started 04/17/23
 - Final TRL-6 test report to be released by early August

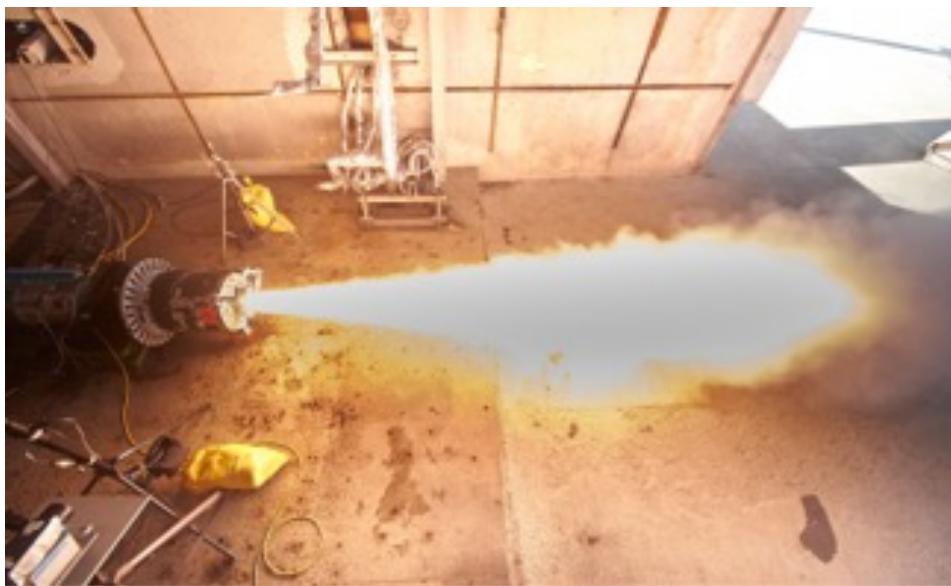

MAV SRM2 (2nd stage) assembly in full duration (20 sec) spinning static test conditioned to relevant Mars temperatures at Northrop Grumman's Elkton test facility on 3/29

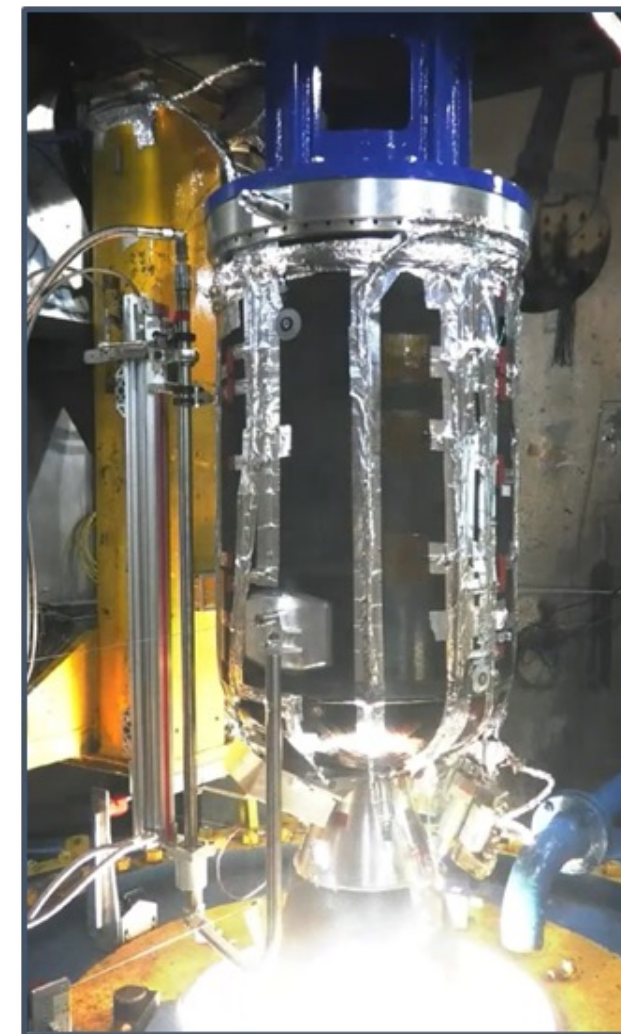

MAV SRM1 (1st stage) assembly in full duration (77 sec) static test conditioned to relevant temperatures and pressure in Air Force Research Lab's test cell on 4/7

NEPA Status and Key Milestones for MSR Campaign Programmatic Environmental Impact Statement (PEIS)

- Notice of Availability (NOA) for Final Tier I PEIS published in Federal Register on June 2
 - Signed by Office of Strategic Infrastructure AA Joel Carney
 - Initiates mandatory 30-day waiting period (2 June – 3 July 2023) before Record of Decision
- Record of Decision (ROD) – NET 3 July 2023 (interagency draft review June 8-23; route for signature at HQ early July)
 - ROD will acknowledge coordination with Dept. of Air Force (DAF) regarding “post-ROD” actions such as preparation activities between now and Earth Entry System (EES) landing / recovery at Utah Testing & Training Range (UTTR)
 - To be signed by SMD AA Nicola Fox
- Tier II effort for MEP's Sample Receiving Project to follow later to cover transportation from UTTR and sample receiving facility

NASA and Other Cooperating Federal Agencies Completed Study of Environmental Impact



FY24 President's Budget Request

- To maintain progress in FY24 towards earliest possible launch date, FY24 budget request is \$949.3M
 - SRL launch as early as 2028, ERO/CCRS launch as early as 2027, with sample return as early as 2033
 - Descope options cited include potentially one helicopter
 - Supply chain issues and inflation affecting all aspects of the campaign
- On June 3, President Biden signed H.R. 3746, the *Fiscal Responsibility Act of 2023*
 - Holds all non-defense discretionary spending for FY24 to no more than FY23 levels
 - Holds all non-defense discretionary spending for FY25 to no more than FY24 levels + 1%
- Congress has not yet passed a budget for FY24

MSR Independent Review Board-2

- Independent Review Board (IRB) will provide independent review of program's readiness for Confirmation
- SMD commissioned a second program IRB to review the Program to ensure that the program has completed Formulation with an executable technical baseline, and has developed realistic cost and schedule estimates to take forward to Agency Confirmation
 - Chaired by Orlando Figueroa
- Designed to perform IRB activities between the Program Element PDRs and the Program PDR, with completion targeted by the end of August
- The IRB's objectives and scope are derived from the MSR Pre-Phase A IRB convening memo, and updated to address focused questions bearing on Confirmation for a complex and distributed program such as MSR

MSR will be the most reviewed early mission concept, with the intent of ensuring the design has been thoroughly reviewed, increasing confidence in the associated cost and schedule estimates to inform the agency's Confirmation decision.

Summary

- MSR progress in Formulation
 - Mars Ascent Vehicle first and second stage solid rocket motors testing complete
 - Sample Recovery Helicopter on-track for PDR September
 - System-level PDR will be conducted following on-going Independent Review Board activity (IRB completion planned for end-August)
- MSR samples of ancient martian rocks will be the first scientifically-selected samples made available to the world's laboratories to answer fundamental questions about early evolution of a habitable world, and the origin of life in our solar system
- FY'24 budget is likely to be challenging

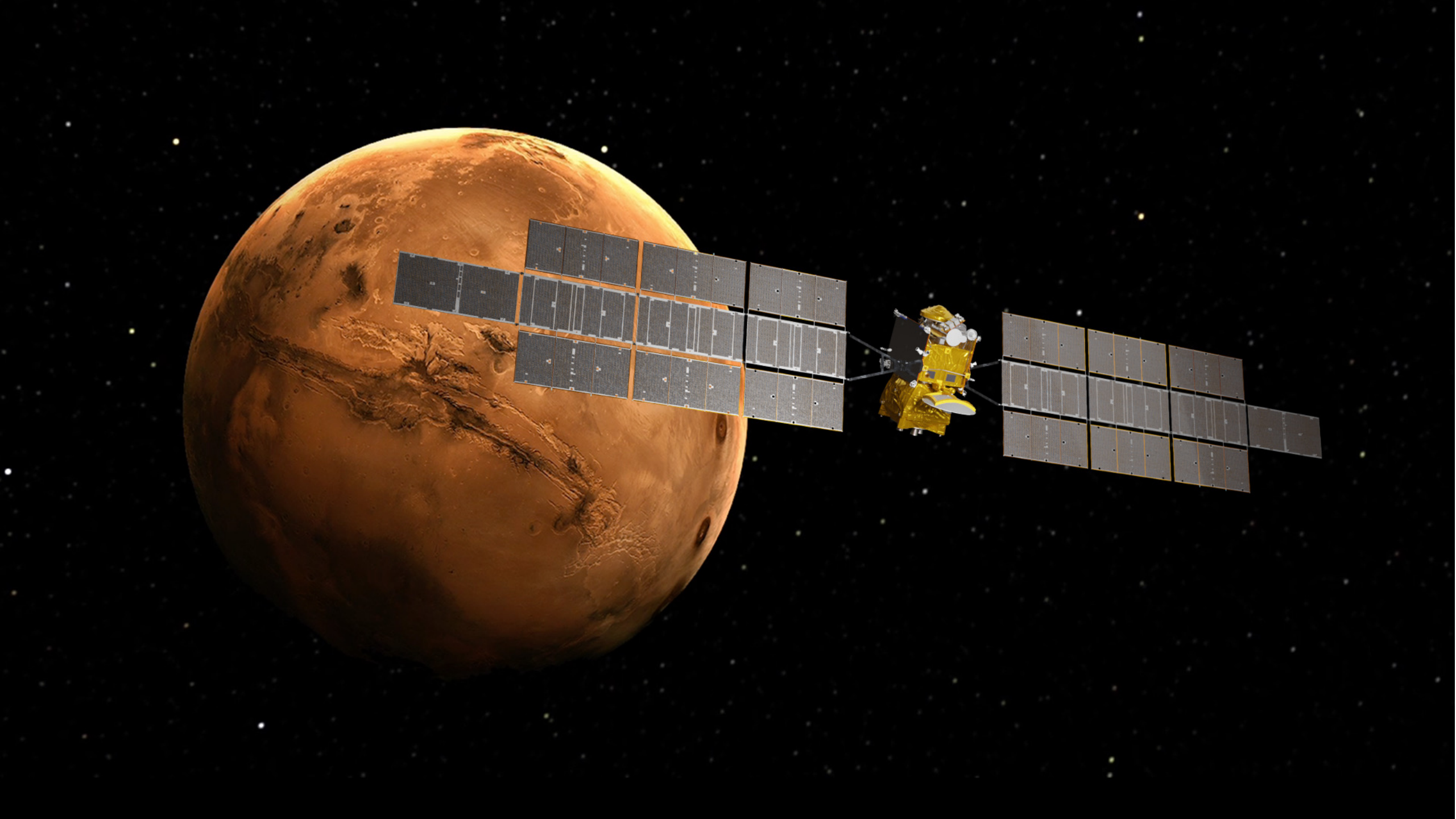



Acronyms

- CM: Containment Module
- CCRS: Capture Containment and Return System
- CONOPS: Concept of Operations
- CP: Chemical Propulsion
- CS: Cruise Stage
- DOF: Degree of Freedom
- DP9: JPL Design Principles, Revision 9
- EE: End Effector
- EES: Earth Entry System
- EP: Electric Propulsion
- ERO: Earth Return Orbiter
- GNC: Guidance, Navigation and Control
- HEEET: Heatshield for Extreme Entry Environments Technology
- IRD: Interface Requirements Document
- IDRA: Interface Definition and Requirements Agreement
- ITT: Invitation to Tender
- JMIP: Joint Management and Implementation Plan
- LMO: Low Mars Orbit
- LRD: Launch Readiness Date
- LV: Launch Vehicle
- MAPS: Mars Ascent Propulsion System
- MAV: Mars Ascent Vehicle
- MPA: MAV Payload Assembly
- MLS: Mars Launch System
- MEL: Mass Equipment List
- MEP: Mars Exploration Program
- MMOD: MicroMeteoroid and Orbital Debris
- MPA: MAV Payload Assembly
- MRSH: Mars Returned Sample Handling
- MSR: Mars Sample Return
- OS: Orbiting Sample
- PICA: Phenolic Infused Carbon Ablator
- PLV: Propulsive Landing Vehicle
- (B)PP: (Backwards) Planetary Protection
- PPO: Planetary Protection Officer
- QPM: Quarterly Progress Meeting
- RSTA: Returned Sample Tube Assembly
- RTAS: Robotics Transfer Assembly System
- SRL: Sample Retrieval Lander
- SRF: Sample Receiving Facility
- SRH: Sample Recovery Helicopter
- STA: Sample Transfer Arm
- STS: Sample Transfer System
- SOI: Statement of Intent
- TAA: Technology Assistance Agreement
- TGO: Trace Gas Orbiter
- TPS: Thermal Protection System
- TRN: Terrain-Relative Navigation
- VECTOR: Vertical Ejection, Controlled Tip-off Rate launch mechanism
- UTTR: Utah Test and Training Range