

Hand-Held Hubble: PVC Model Complete Instructions

Safety First!

Safety First!



This symbol, which appears throughout the instructions for building the model, reminds you to use caution when performing certain tasks and to have an adult present.

Before getting started, it's very important that you read and understand the following safety rules because you'll be using some tools (a saw and a drill) to build the model. While tools are easy and safe to use when used properly and with adult supervision, the improper use of tools — whether powered by hand or by electricity — can result in serious injury to yourself or others.

- Make sure you have an adult present before you begin using any of the tools.
- Have an adult inspect all tools before you use them. Do not use tools that appear damaged (frayed cords, cracks, dull cutting blades, etc.).
- Have an adult show you how to use each tool safely and supervise you while you use them.
- Keep your work area well-lighted and clear of clutter.
- Carry tools properly. All sharp-edged tools should be carried with the cutting edge down. Never carry sharp tools in a pocket!
- Do not wear loose or baggy clothing, ties, jewelry, or sandals. If you have long hair, tie it back or wear a cap — especially when drilling.
- Wear eye protection when sawing and drilling. Safety glasses or goggles are inexpensive and available at any hardware store.
- Do not hold your finger on the switch button while carrying a plugged-in tool — it may start accidentally.
- Grip all tools firmly.

- Keep your mind on your work. Avoid distractions such as loud music or conversation.
- When sawing or drilling, make sure you clamp the material you are working on securely to a table or other solid surface with a C-clamp or vise.
- When sawing, make sure to cut away from your body and to keep your hands away from the cutting zones.
- When drilling, pay attention to what is underneath the piece being drilled. Be sure that drilling is done into a secure block of scrap wood or into a clear space.
- Be careful when handling materials that have just been drilled or sawed — the edges may be sharp!
- Be sure to work at a safe distance from others.
- Do not use electric power tools in wet or damp locations.
- Never carry a power tool by its cord.
- Never leave a running power tool unattended.
- When unplugging a power tool, first be sure that it has stopped running. Then unplug it by grasping the plug — not the cord!

Start with a look the PVC Model: Materials List (See PDF)

Instructions



1. Measure and cut the PVC pipes. Clamp the pipe to a sturdy surface. From the 3" pipe, measure and cut a 2 3/4" length; from the 2" pipe, measure and cut a 6 3/4" length. (Figures A and B)

2. Sand any rough edges from the cut pipes. In addition, sand off any printing on the pipes to prevent it from

Cutting the dowel



Figure C

The easiest and safest way to cut the dowel is to “score” it first. To do this, make a deep groove around the dowel at the desired measurement with a sharp pair of scissors. Twist the scissors around the dowel a few times until you see the groove. Then gently snap the dowel along the groove.

showing through the paper wrapper later.

3. Wash the cut pipes with dish soap to get rid of any dirt, oil, or flakes left behind by the saw. Dry the pipes thoroughly.

4. Cut four 6 1/4" x 2" pieces out of the posterboard. Set aside the rest to use later.

5. Cut the black construction paper into one 5" x 6 1/2" sheet.

6.  Cut the wooden dowel into one 12" length and one 9" length. (Figure C)

7. Paint the dowels and the beads with the silver paint and allow them to dry.

8. Cut out the Aperture Door and Aft Bulkhead sections from Page 1 of the printed wrapper pages (you needn't be accurate because you'll be trimming them once they're glued to the poster board). Using white glue or a glue stick, attach each section to a piece of poster board (don't use the 6 1/4" x 2" pieces you cut out earlier). Allow them to dry, then cut them out carefully and set them aside.

9. Cut out the remaining sections of the wrapper. Be sure to cut along the heavy outlines.

Measuring and cutting PVC



Figure A

To line up each cut correctly, measure the length you need and mark it at four points around the pipe.



Figure B

You'll get a straighter cut if you use a miter box. Be sure it is secured to your work surface before you cut the pipes. An adult must be present for this step.

Aligning the Forward Shell wrapper

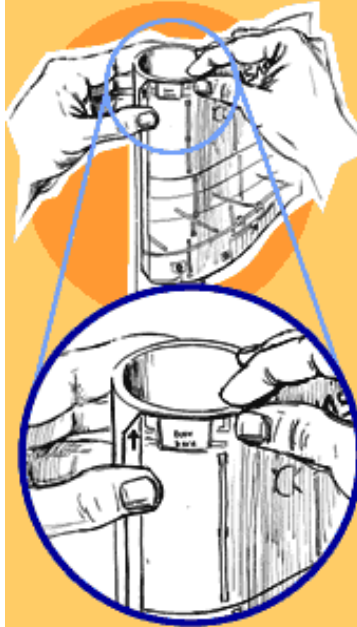





Figure D

When attaching the Forward Shell section of the wrapper, make sure that the edge marked “Attach door here” is lined up at one end of the pipe. There will be about 1/2" of pipe left bare at the other end.

10. Construct the Forward Shell. Tape the Forward Shell section of the wrapper securely to the 2" PVC pipe with cellophane tape. Be sure to first attach the end with the flap marked “Attach this end first.” Align the top of the Forward Shell wrapper with the edge of the pipe. (Figure D)

11. Prepare to drill holes in the Forward Shell. Determine the locations of the four holes to be drilled. They are marked with the symbol  in four places around the Forward Shell. Then clamp the Forward Shell securely to your work surface.

12.  Drill four holes in the Forward Shell using a drill with a 3/16" drill bit. Drill right through the four  symbols in the wrapped pipe. (Figure E) Be careful not to drill all the way through the other side of the pipe!

13. Insert the unwrapped end of the Forward Shell into the wide end of the bushing. It should fit securely. (Figure F)

Figure F

Into the bushing...

The widest end of the bushing is the only end into which the Forward Shell assembly will fit properly. It should be a tight fit.

Drilling the holes



Figure E

Make sure the Forward Shell is clamped securely to your work surface. Drill right through the four  symbols marked on the wrapper. An adult must be present while you use the drill.

Figure F



Constructing the mirror assembly

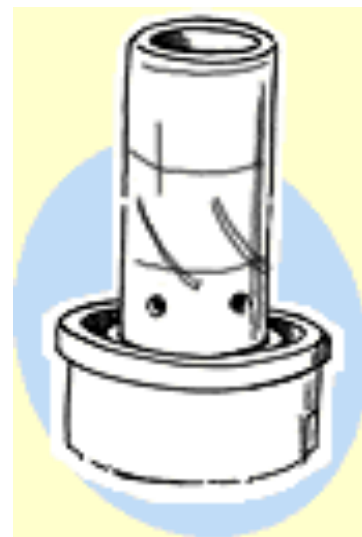

Figure G

Use a loop of duct tape to attach the mirror to the test cap (as shown). If you can't find a test cap, you can insert the mirror without it. Use plenty of tape to prevent the mirror from falling through the opening.

14. Attach the mirror to the test cap with a loop of duct tape. This is now the mirror assembly. (Figure G)

15. Insert the mirror-and-test cap assembly face-down into the open end of the bushing and secure it with cellophane tape. Make sure that the tape does not go outside the bushing. (Figure H)

Installing the mirror assembly

Figure H

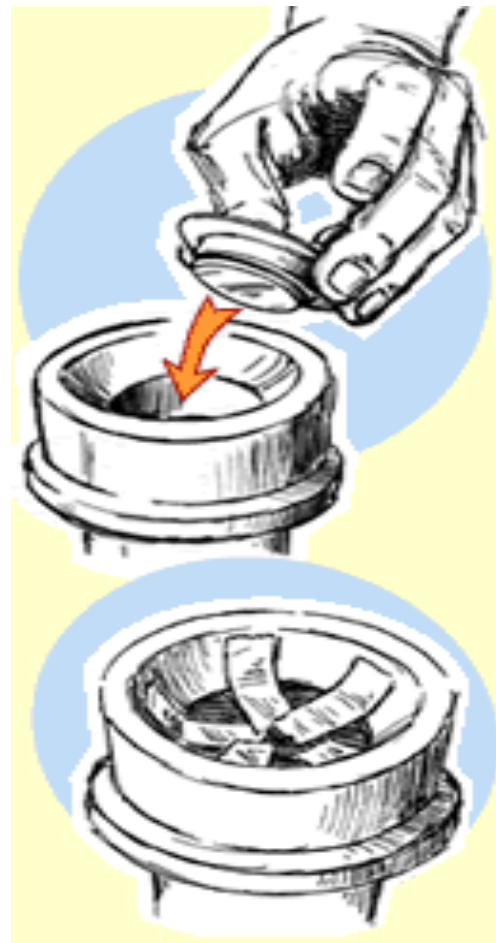

Install the mirror assembly into the open end of the bushing as shown. Once it's installed, you should be able to see your reflection in the mirror when you look down the barrel of the Forward Shell.

Constructing the Aft Shroud

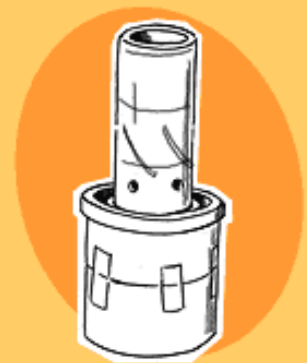

Figure I.

Several pieces of cellophane tape placed lengthwise across the seam will hold the two pieces that form the Aft Shroud — the bushing and the 3" PVC — securely.

Aft Shroud wrapper (Part A)

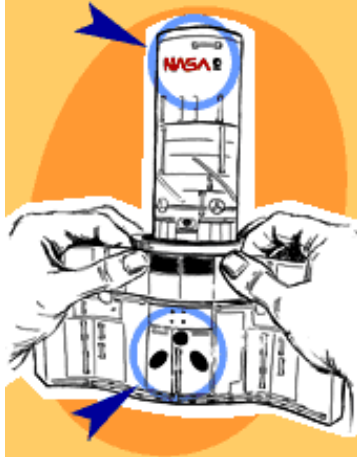

Figure J

When attaching Part A of the Aft Shroud wrapper, make sure that the NASA logo, the two rectangular vents, and the three circular shapes form a straight line.

16. Prepare to construct the Aft Shroud by securing the 3" PVC pipe to the wide end of the bushing with several pieces of cellophane tape. (Figure I)

17. Insert the drain cap in the open end of the 3" PVC and tape it together.

18. Attach the Aft Shroud wrapper (which comes in two parts) to the taped-together 3" PVC pipe. First, line up Part A of the wrapper so that the three circular shapes are directly below the NASA logo. Tape the wrapper in place with cellophane tape. (Figure J)

19. Line up Part B of the Aft Shroud wrapper along the dotted lines on Part A and secure it with cellophane tape. Check that the wrapper's features are lined up correctly. (Figure K)

Figure K



When attaching Part B of the Aft Shroud wrapper, note that the pattern continues underneath the overlap. Make sure everything is lined up correctly before you tape it down.

Snapshot:
How it fits together

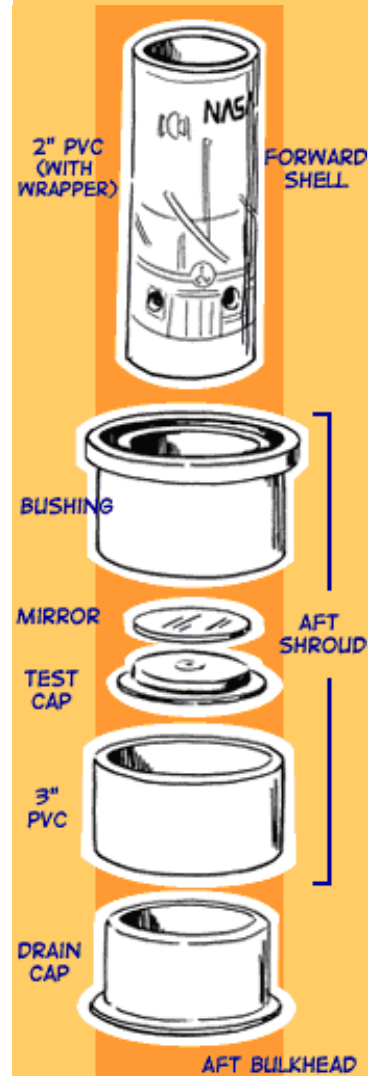

This is how the individual pieces of the Hubble model's body should be put together.

Assembling the Solar Panels

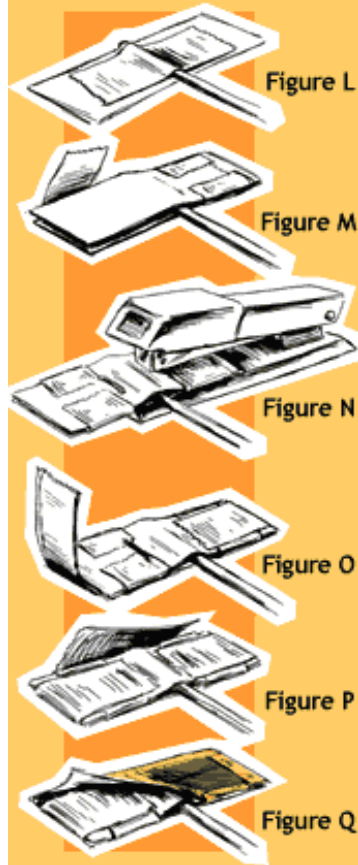

If you follow all of these steps, the layers of tape and paper will make your solar panels strong.

20. Begin assembling the Solar Panels. First, center one of the 6 1/2" x 2" poster board rectangles over the end of the 9" length of dowel. Tape it securely with duct tape. (Figure L)

21. Line up a second poster board rectangle on top of the first one, sandwiching the dowel between the two. Tape the pieces together with duct tape. (Figure M)

22. Staple once on either side of the dowel for extra stability. Staple as close to the dowel as possible. (Figure N)

23. Seal both ends of the panel with duct tape. (Figure O)

24. Seal the outside edge of the panel (where the dowel ends) with duct tape. (Figure P)

25. Attach the Solar Panel wrapper by wrapping it around the poster board "sandwich." First fold it along the dotted line — then secure it with cellophane tape. (Figure Q)

26. Insert the bare end of the dowel all the way through the set of drilled holes in the Forward Shell that are marked "Solar Panel."

27. Repeat steps 20–25 to construct the second Solar Panel on the bare end of the dowel you just inserted through the Forward Shell. Make sure both the panels have the same side facing up. Then center the completed Solar Panel assembly in the Forward Shell.

Snapshot: The Solar Panels

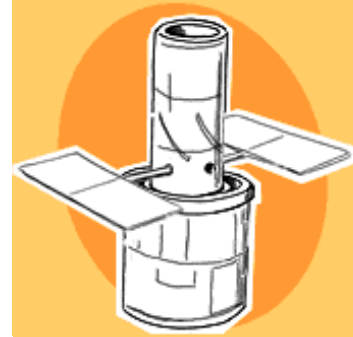

This is what your model should look like with the Solar Panels attached. Remember to put the dowel through the holes before attaching the second Solar Panel!

Attaching the Aperture Door

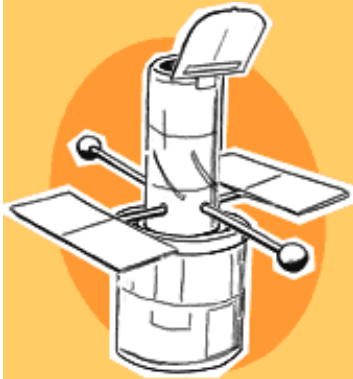

Figure R

Once you've attached the Aperture Door (as shown), you might want to leave it open. On the real Hubble Space Telescope, the Aperture Door is usually open to allow light to enter... although it can be closed to protect the mirror and instruments from space debris.

28. Insert the 12" length of dowel into the set of drilled holes marked "Antenna." Glue a bead onto each end of the dowel by applying a drop of white glue inside the bead's pre-drilled hole and then inserting the dowel. If the dowel is too big to fit into the bead's hole, sand it down to size with sandpaper.

29. Fold or lightly score the Aperture Door cutout on the dotted line so it will bend easily. Place a piece of cellophane tape across both sides of the fold to reinforce the "hinge." Then tape or glue the Aperture Door to the Forward Shell where marked with "Aperture door attaches here." (Figure R)

30. Tape the Aft Bulkhead cutout onto the bottom of the model (over the drain cap).

31. Construct the Light Baffle. Loosely roll the black construction paper (starting at the 5-inch side) and insert it into the front of the Forward Shell. The "roll" should be 5 inches tall. You may secure it with cellophane tape if you wish. (Figure S)

It's all done!

Inserting the Light Baffle

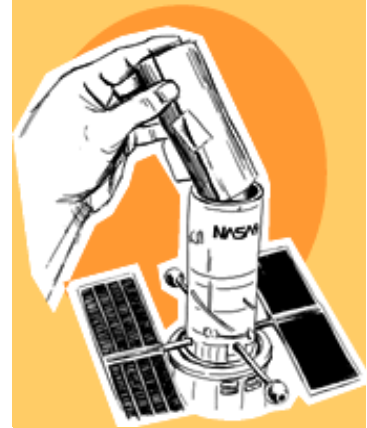

Figure S

Drop the rolled-up Light Baffle into the barrel of the Forward Shell (as shown). The dowel representing the Communications Antennae will stop it from going in too far. On the real Hubble Space Telescope, the Light Baffle keeps stray (unwanted) light from bouncing around the inside of the telescope.