

Hubble Space Telescope Expert Model — Exterior



Pattern Pieces: Print this document on 32lb paper

Complete assembly directions and more information
can be found online at www.hubblesite.org/go/model



Completed model (display suggestion)

About this model

This highly detailed model of the Hubble Space Telescope is intended for experienced model-builders. You have the option of also assembling the internal structure of the telescope, including the mirror and the instrument bay, which fits inside the external shell.

The details of this model are based on the telescope's configuration after Servicing Mission 3B in 2002.

This project is not appropriate for young children because of the high level of detail and the use of dangerously sharp tools. The estimated completion time is 30 hours.

Model design by Ton Noteboom

Distributed with permission
by Space Telescope Science Institute

www.hubblesite.org

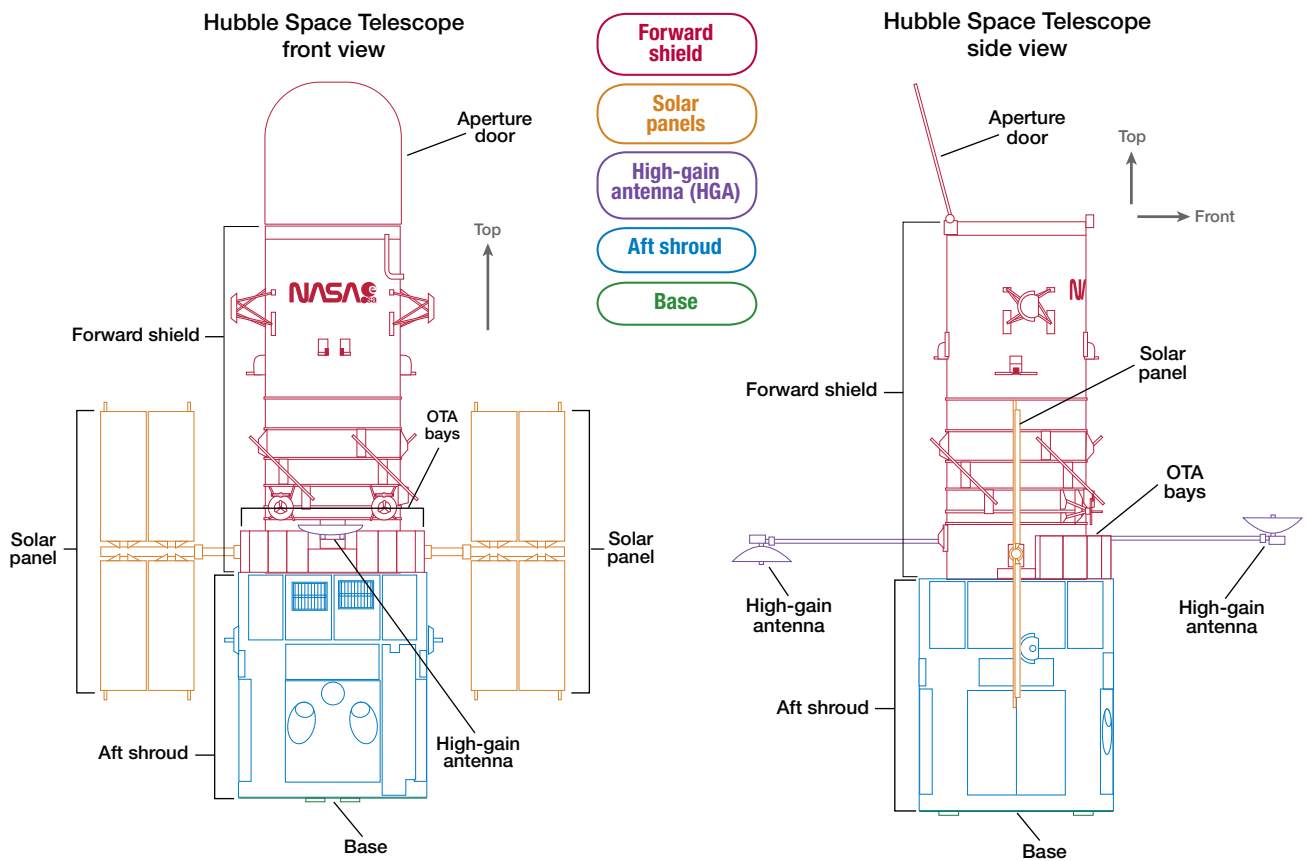

When assembling your model, keep track of which pieces are which by only cutting out the pieces you need for the particular part you are assembling, and lightly write the number of the piece in pencil on the back.

This document should be printed onto 32-lb (120g) paper, ideally in color. (You may want to have extra printouts handy in case you need them.) The directions (in a separate file) can be printed on regular paper in black-and-white.

The parts are in sections color-coded by the part of the telescope they belong to.

1 cm 1 inch

Pattern scale:

This model is designed to be at 1:48 scale relative to the real Hubble Space Telescope.

To ensure your model hasn't been resized during printing, measure this scale.

Pattern key:

This piece's number

Cut out along outlines

Fold along dashed lines (score before cutting out)

Light blue areas are where glue is applied.

Number of the piece that attaches here

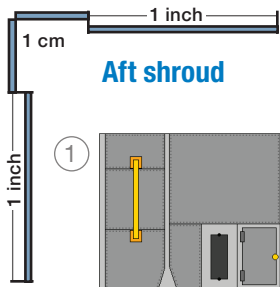

Aft shroud

①

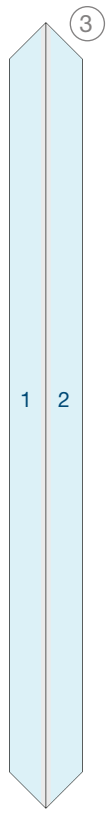
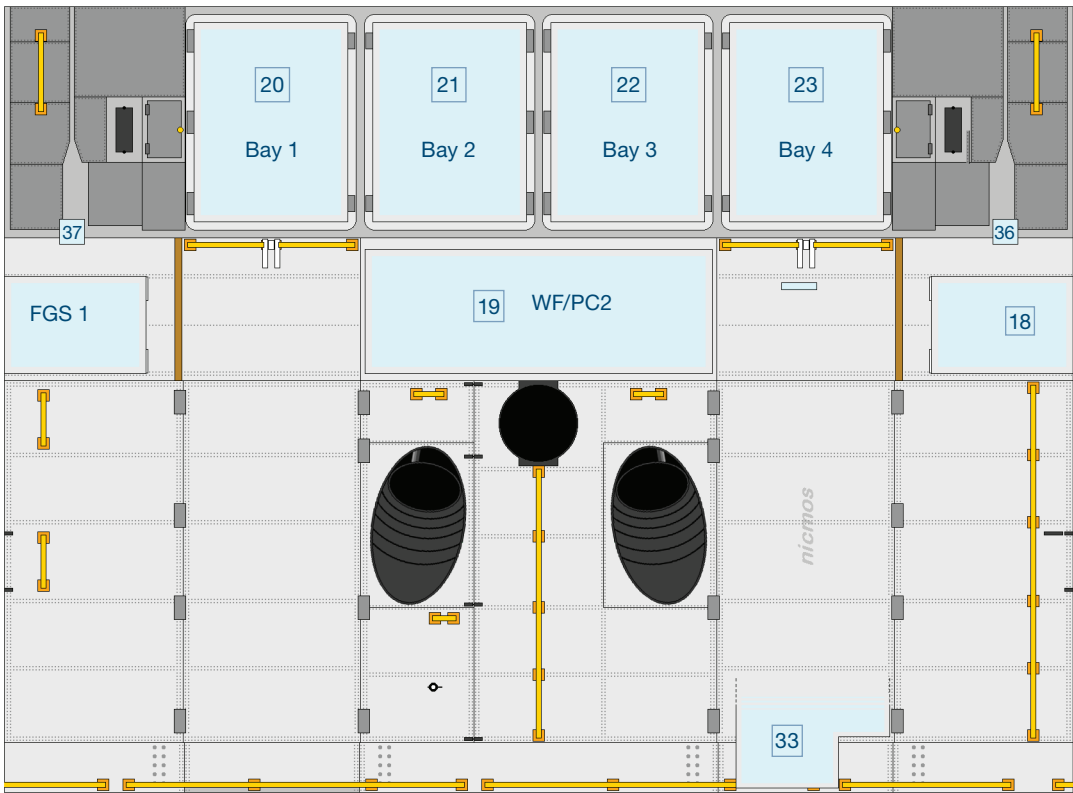

②

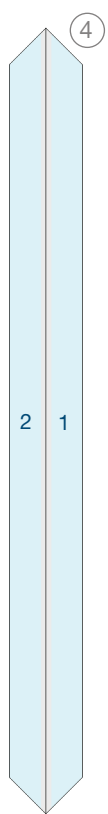
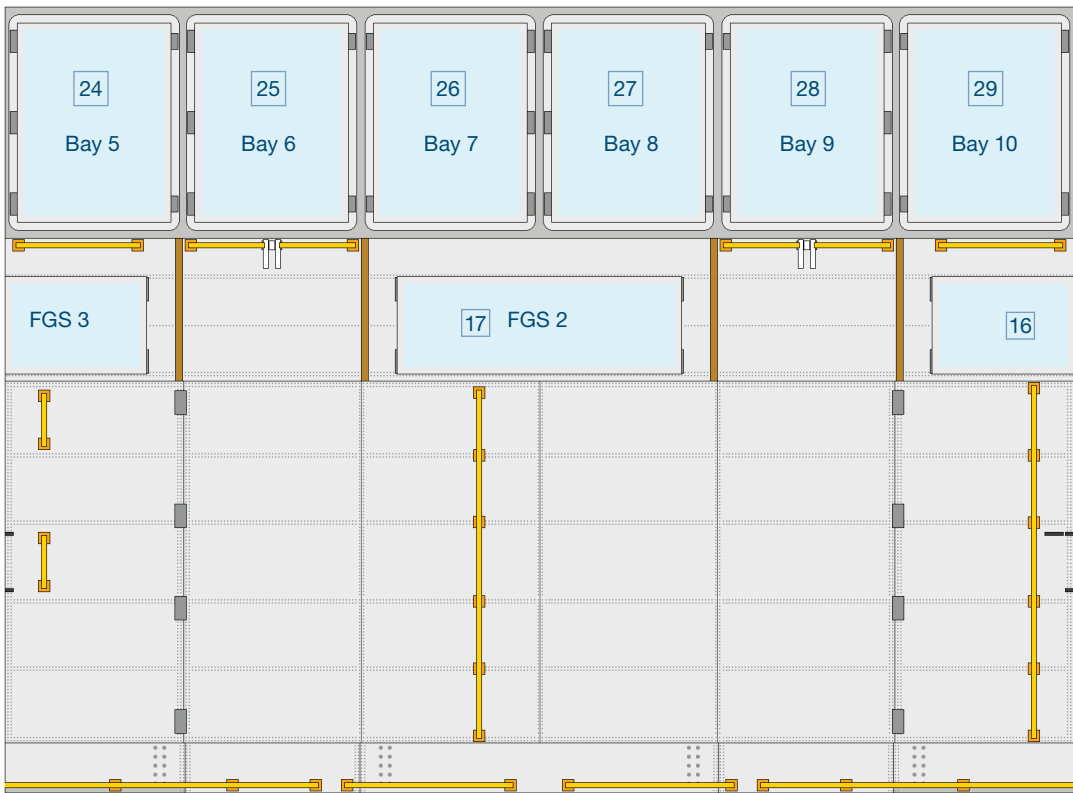

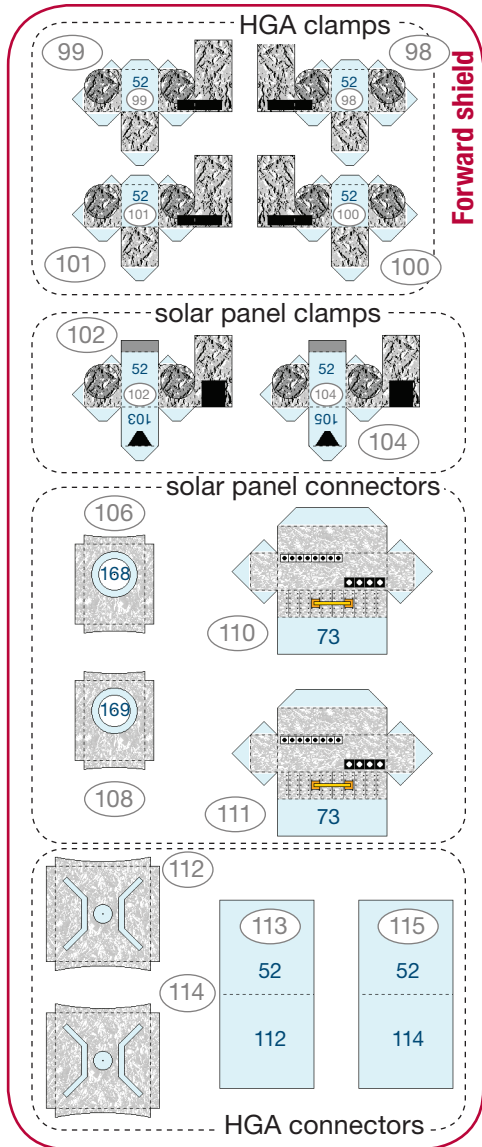
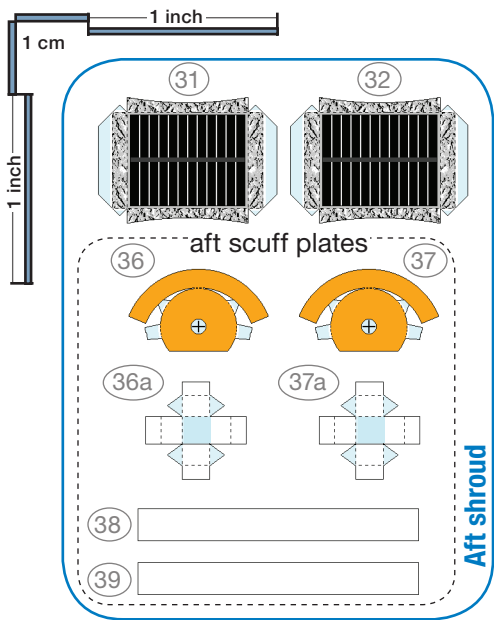

6

8

10

12

14

Aft shroud spacers Cut spacers all the way to the edge of the paper.

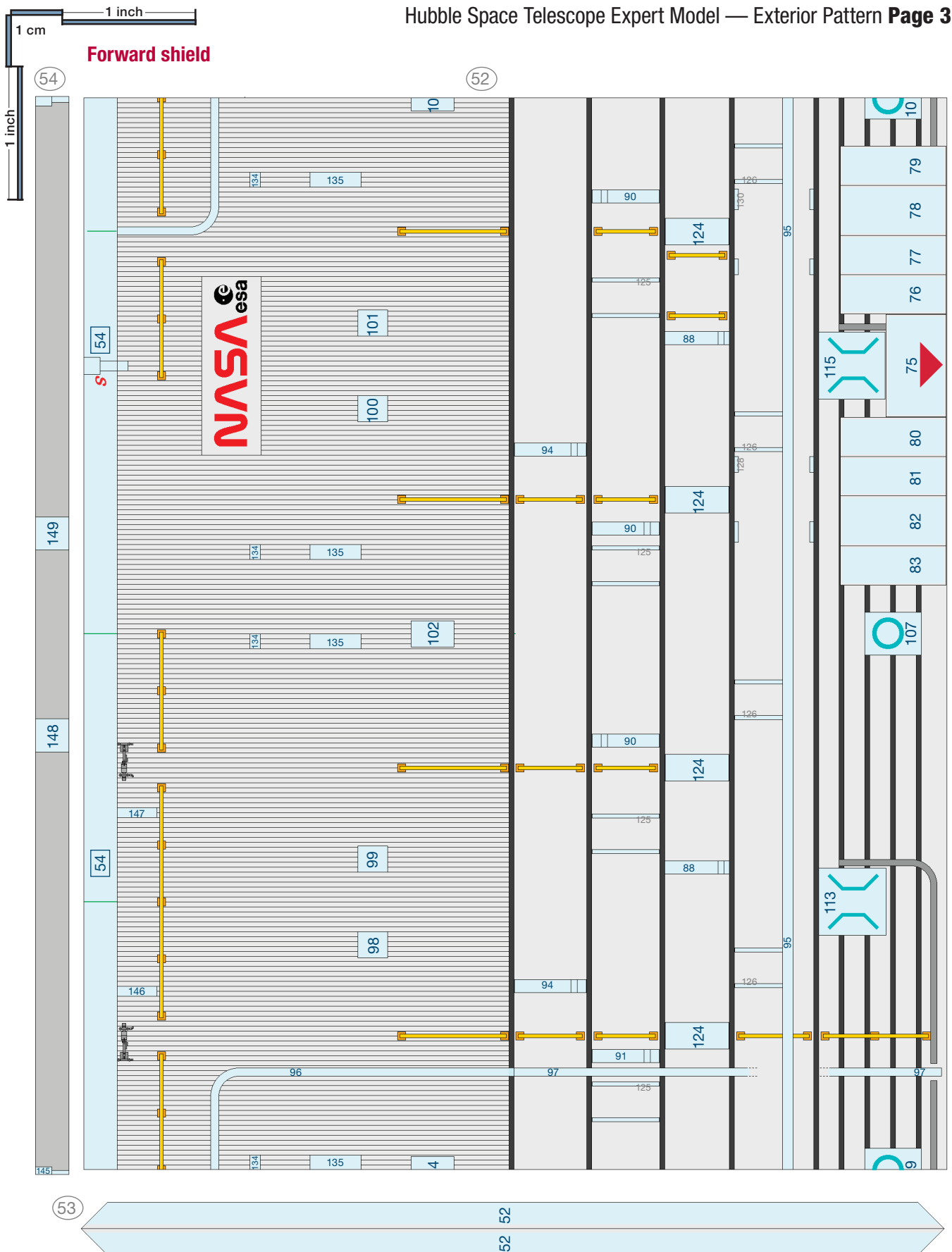

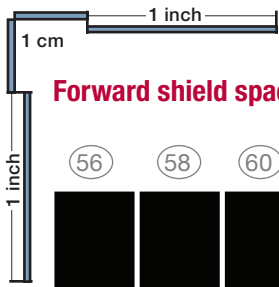

Forward shield spacers

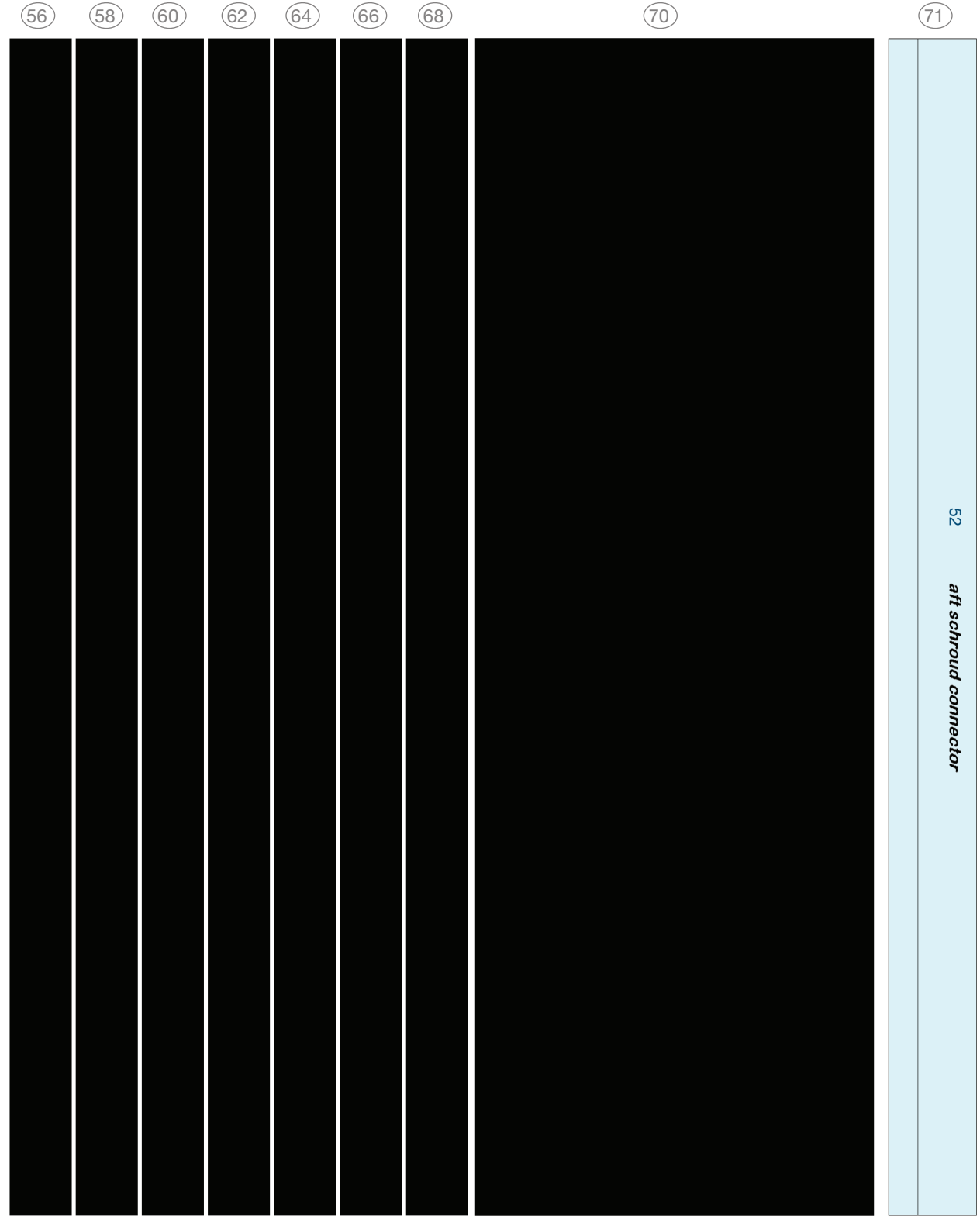

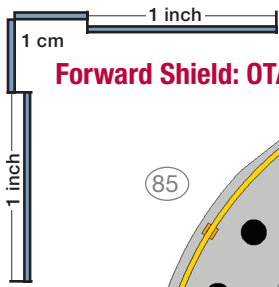

Forward Shield: OTA Bays

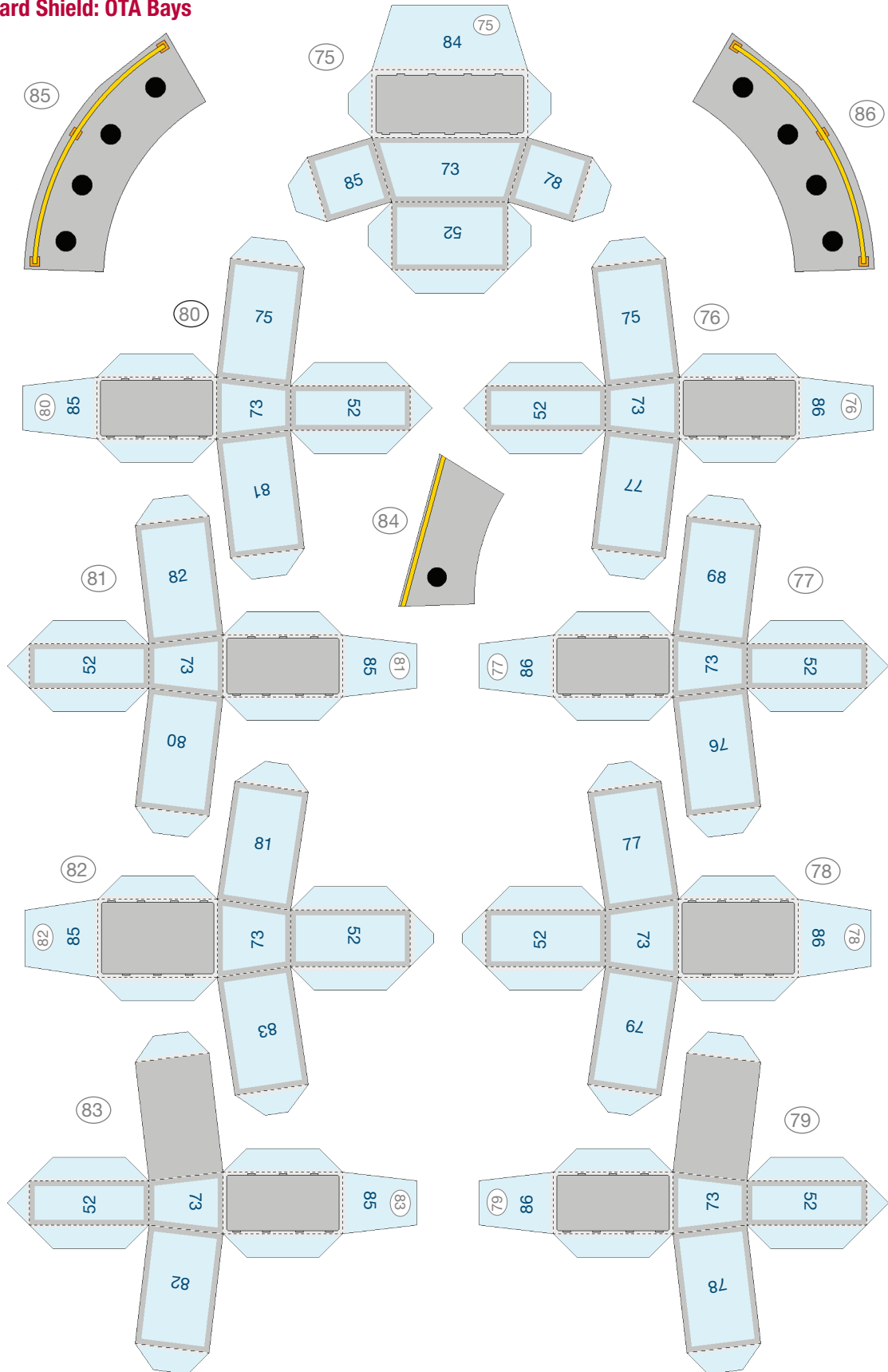

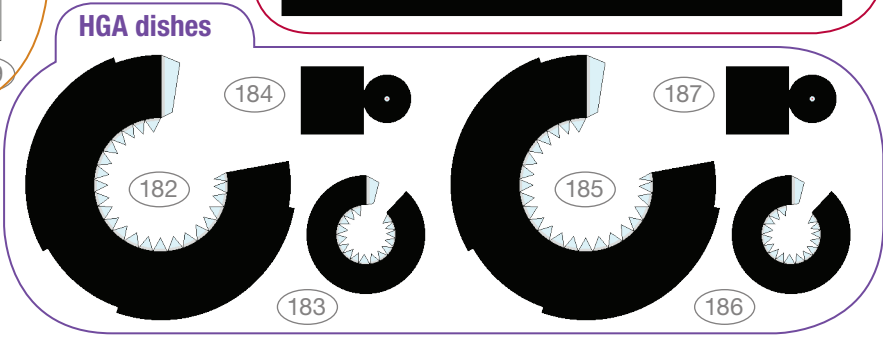
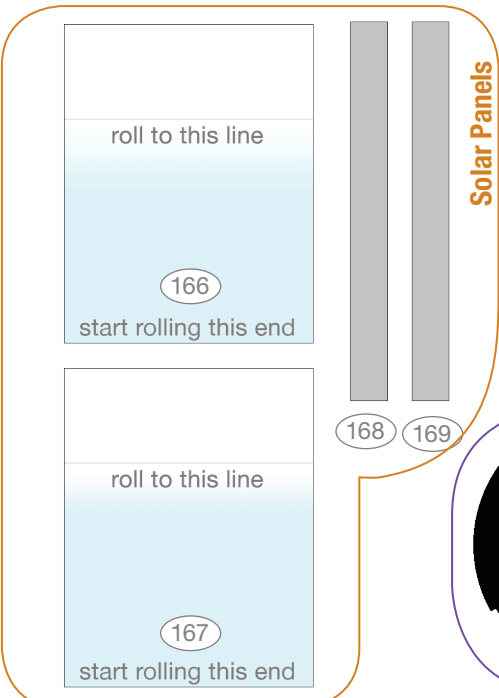
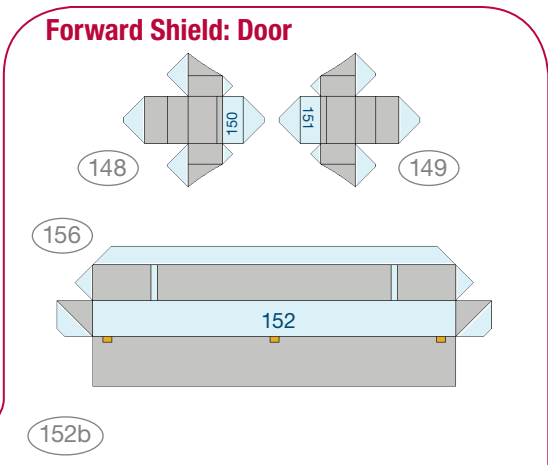
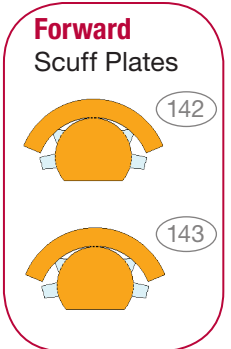
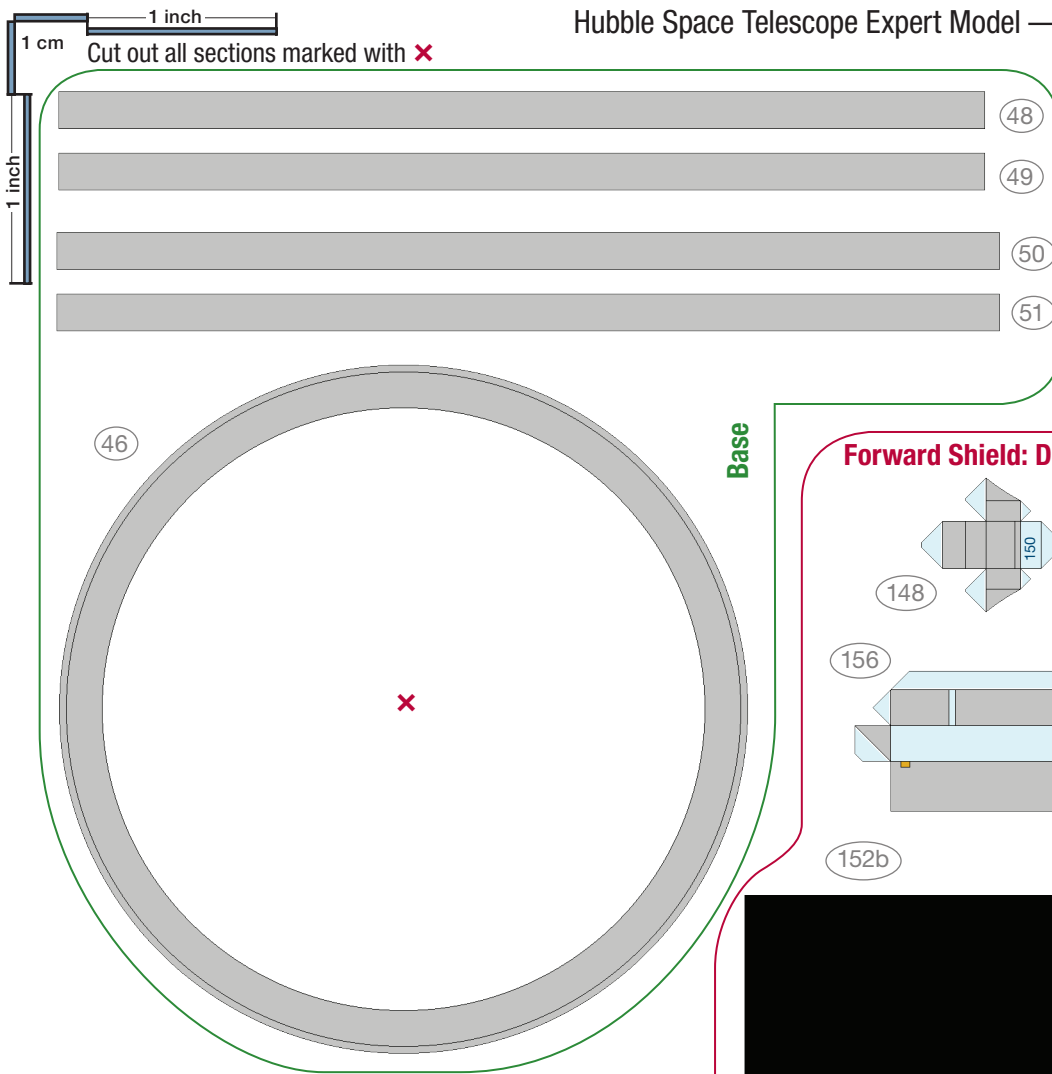

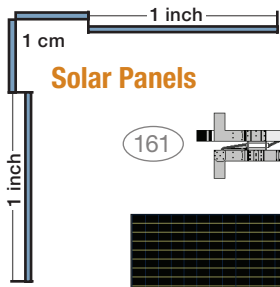

Solar Panels

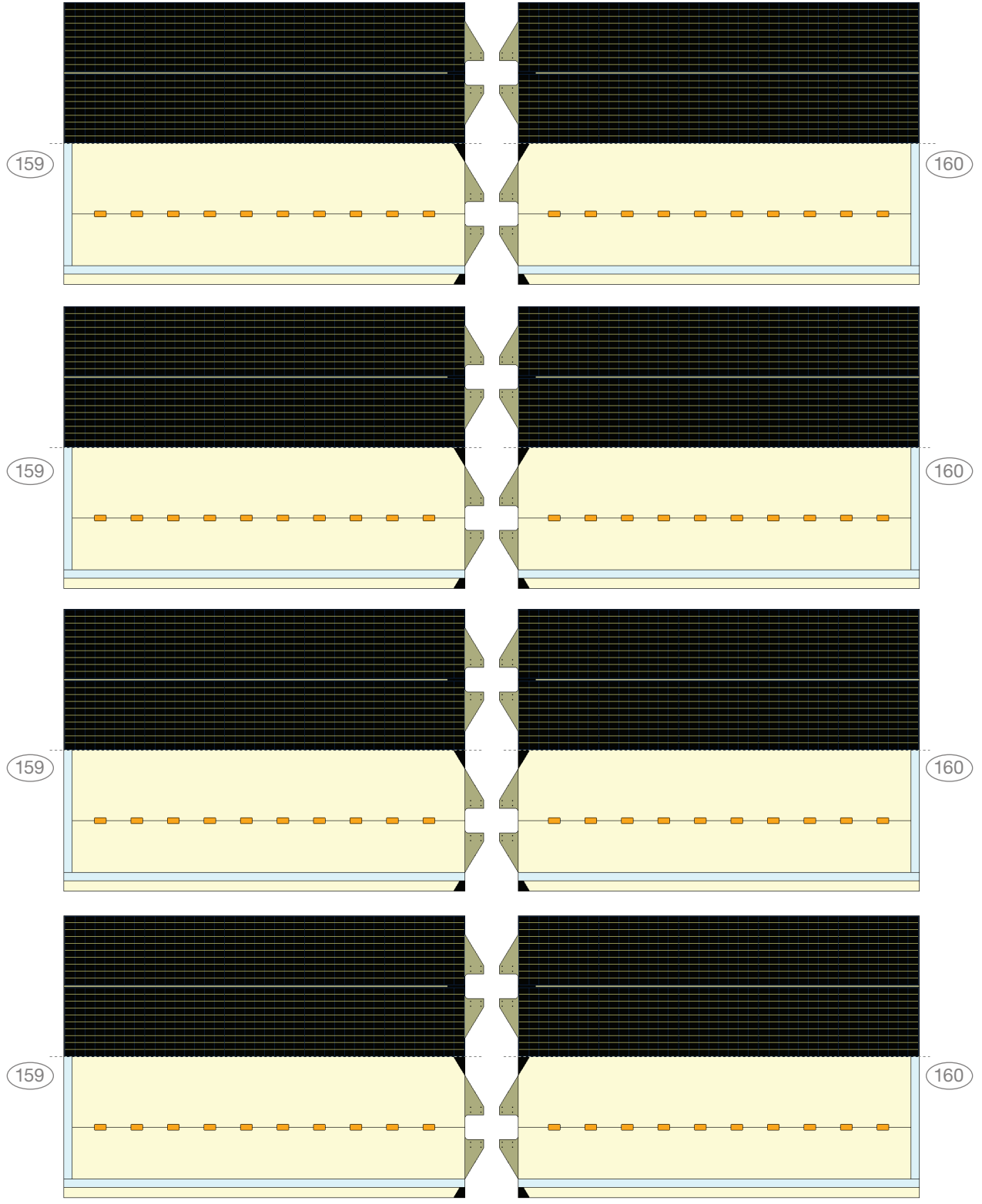

This page should be folded in half along the dotted line and glued together before cutting out the pieces.

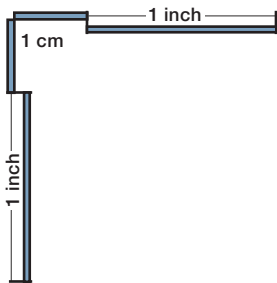
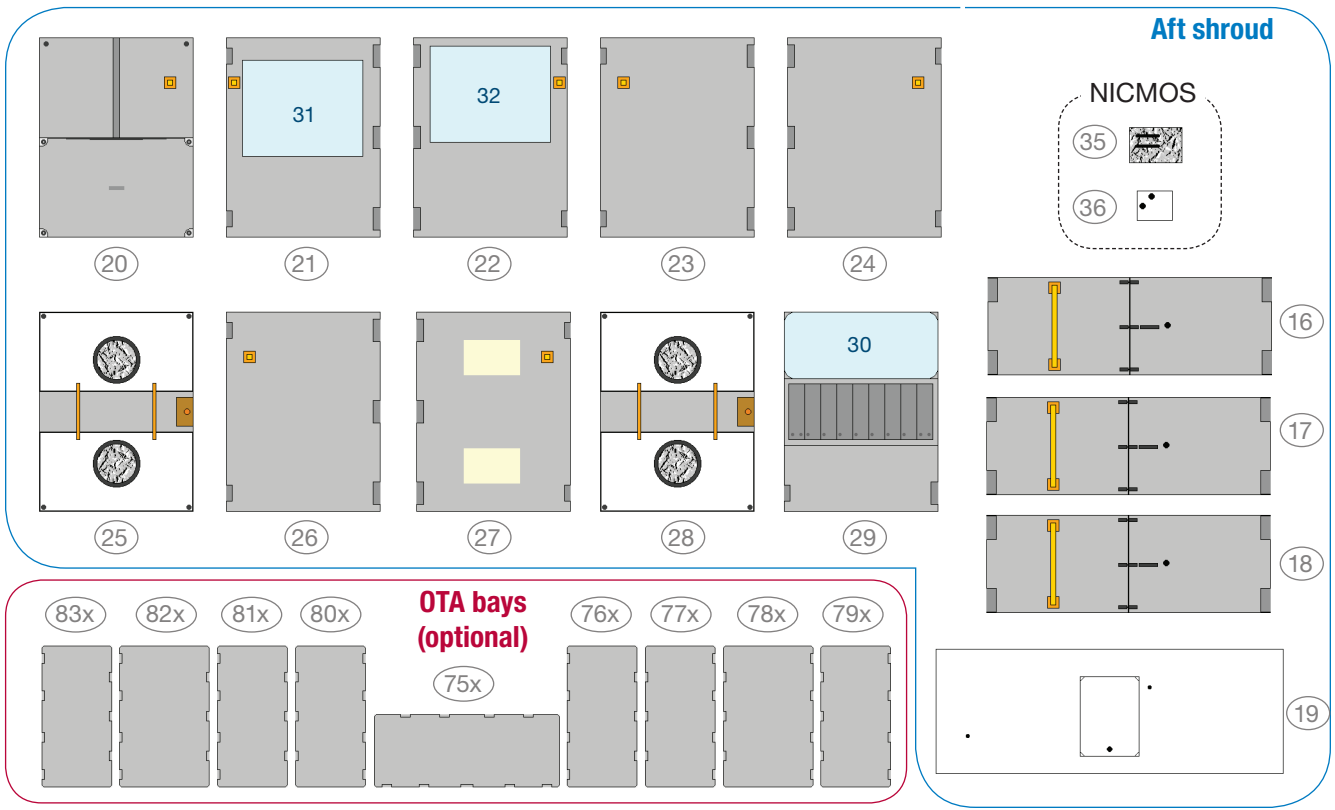

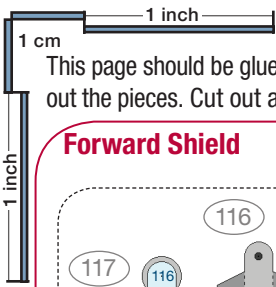

This page should be glued to cardboard before cutting out the pieces. Cut out all sections marked with ✕

Forward Shield

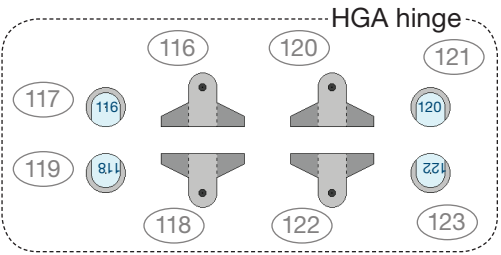

solar panel connectors



solar panel clamps

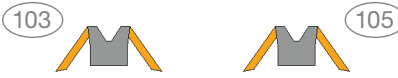

magnetic torquers

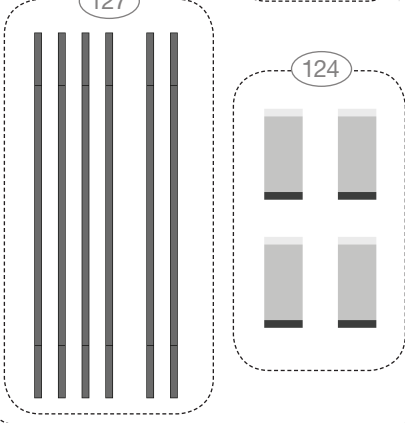
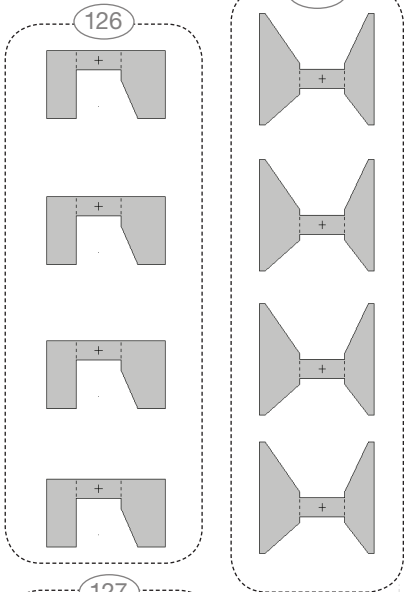

Aft Shroud

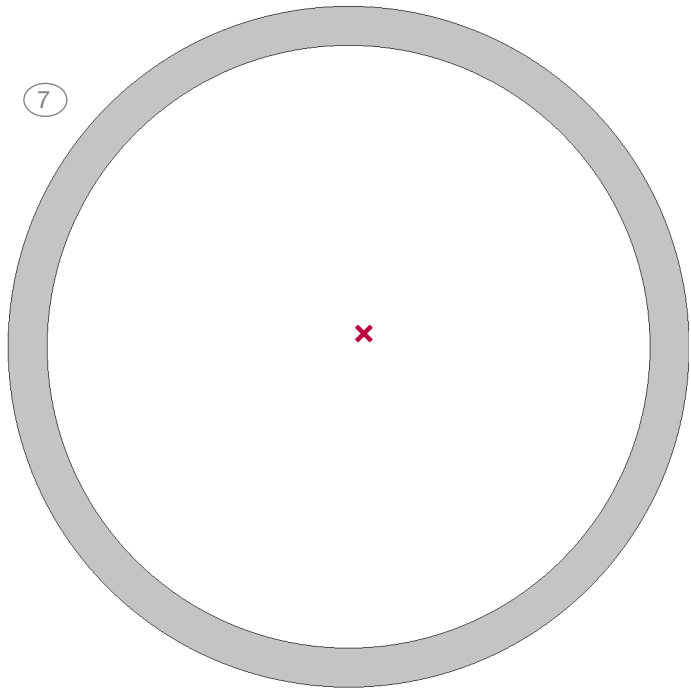
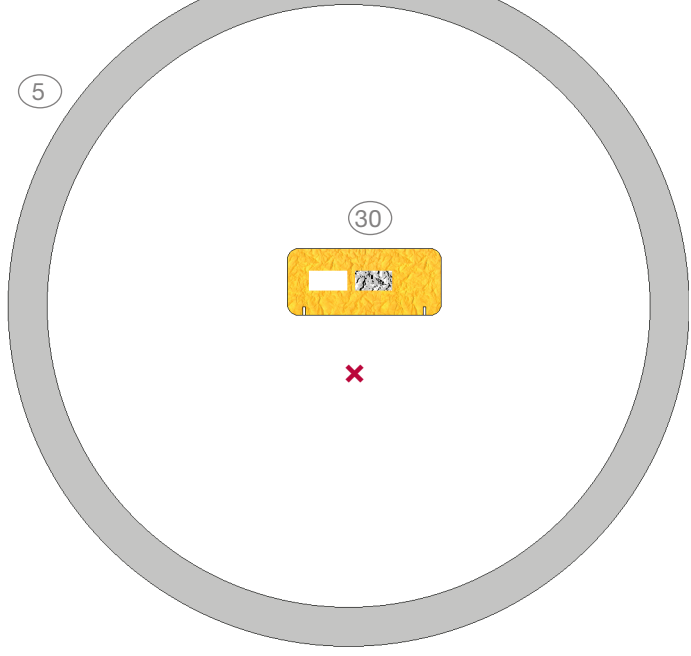

NICMOS

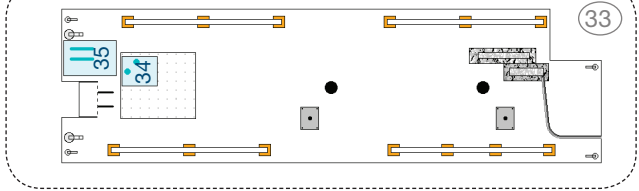

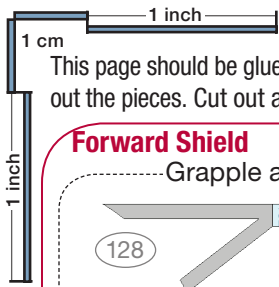

This page should be glued to cardboard before cutting out the pieces. Cut out all sections marked with ✕

Forward Shield

Grapple attachment

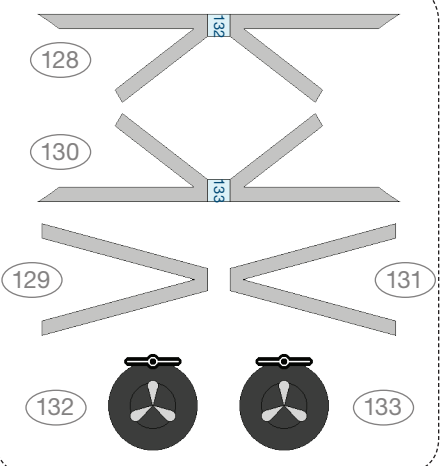

Forward scuff plates

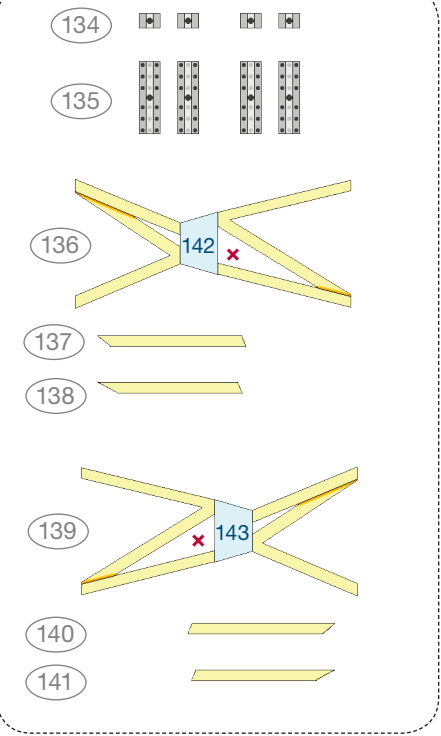

Handrails (optional)

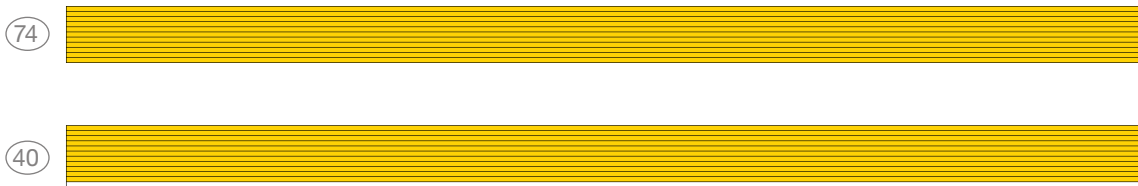

Aft Shroud

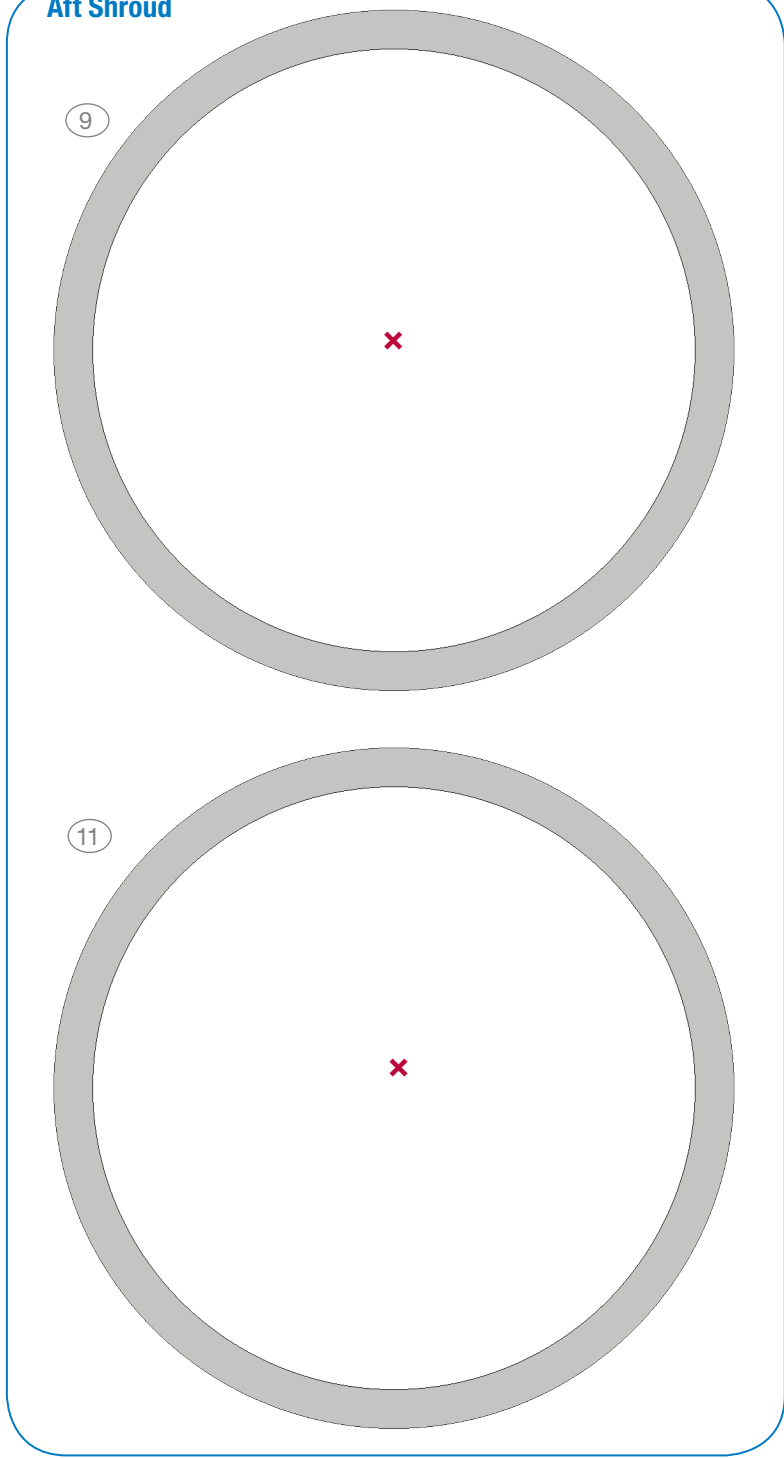

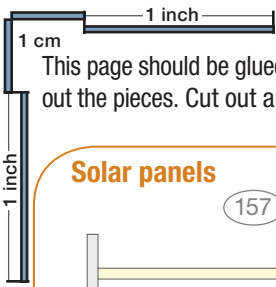

This page should be glued to cardboard before cutting out the pieces. Cut out all sections marked with ✕

Solar panels

(157)

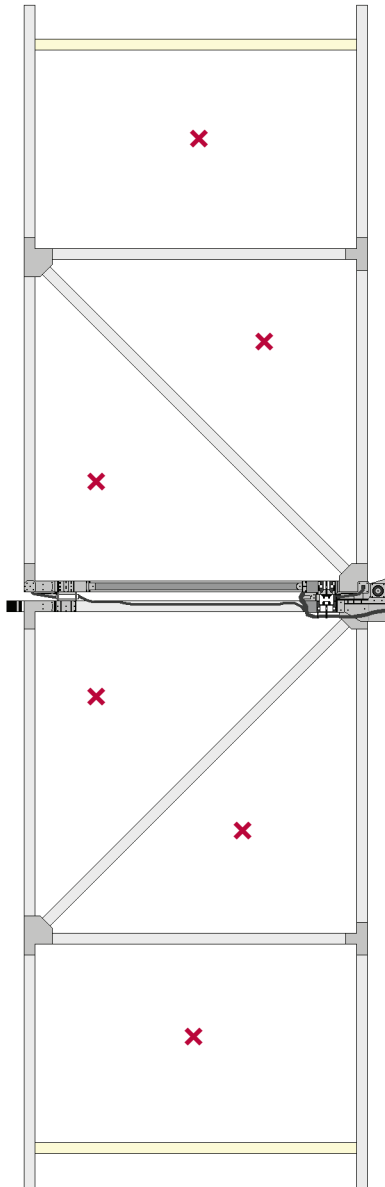

Aft Shroud

(13)

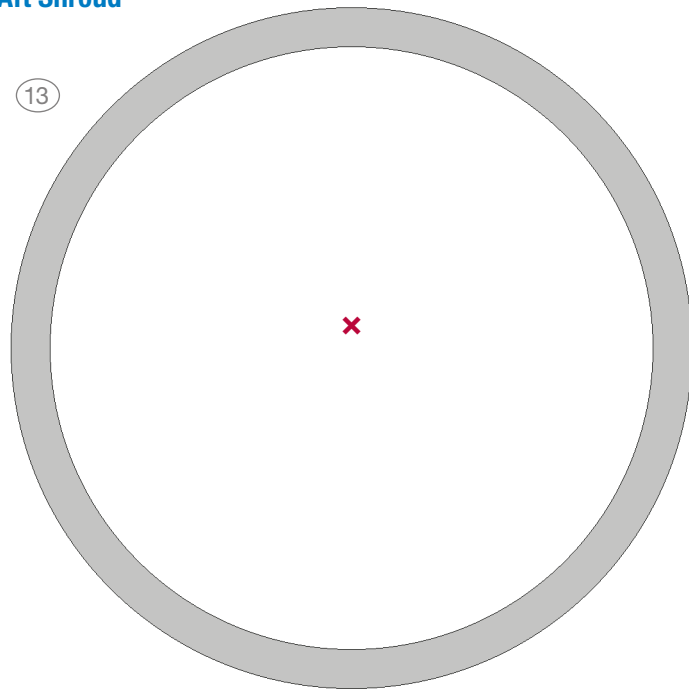

(15)

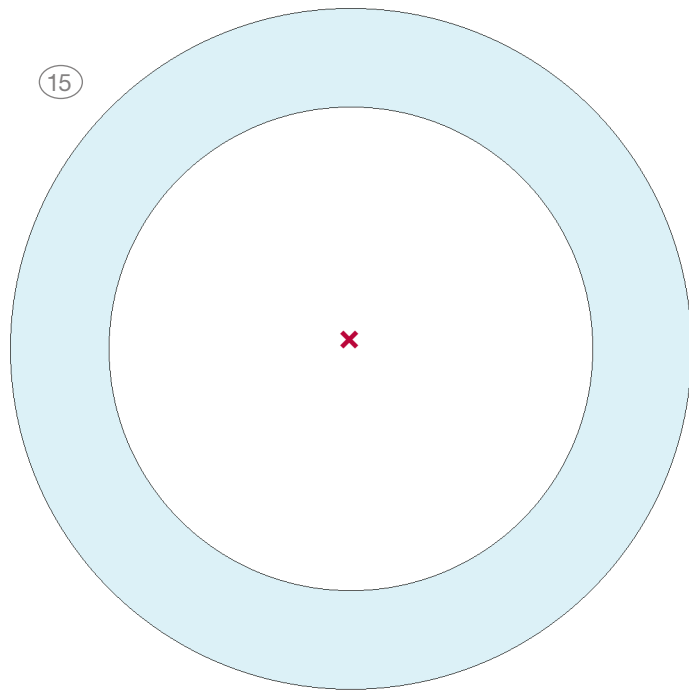

High Gain Antenna (HGA)

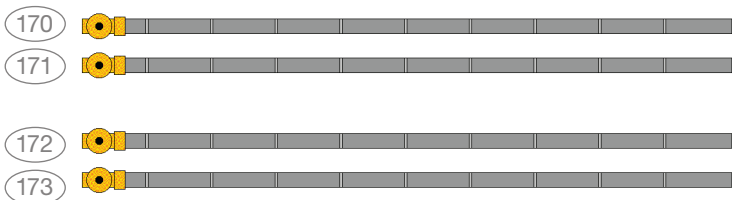
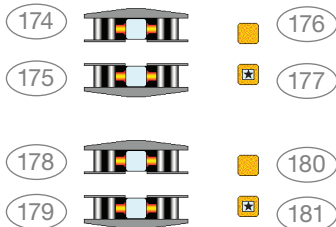

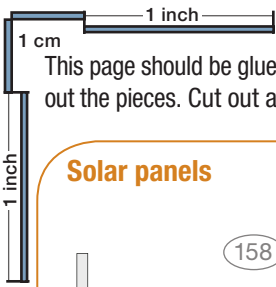

This page should be glued to cardboard before cutting out the pieces. Cut out all sections marked with ✕

Solar panels

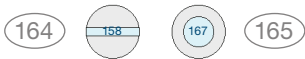
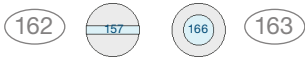
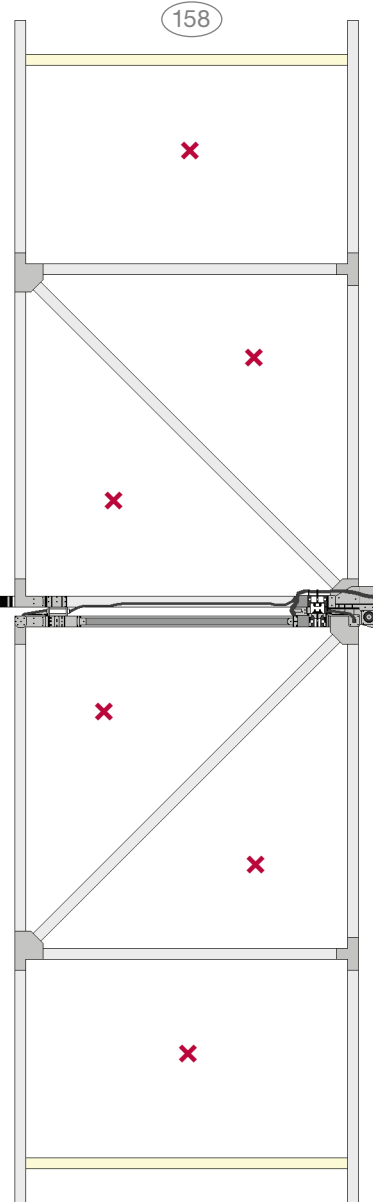

Forward shield: OTA bays

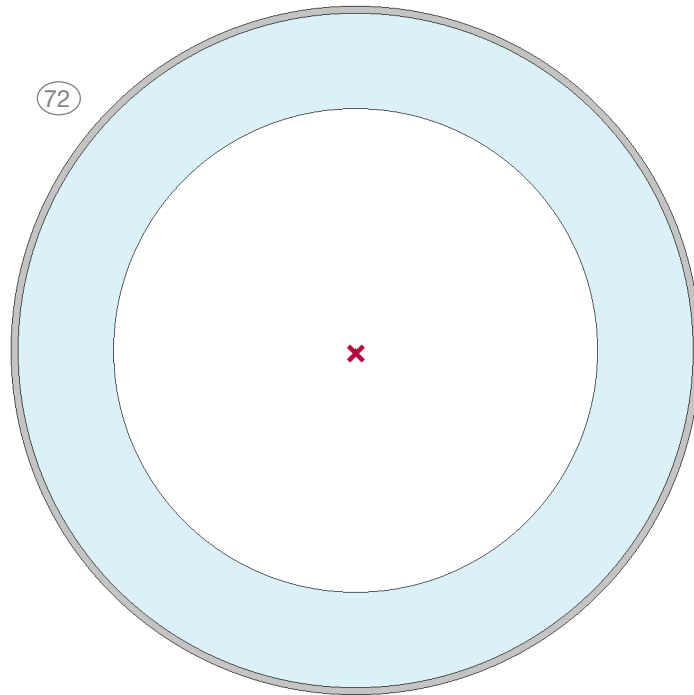
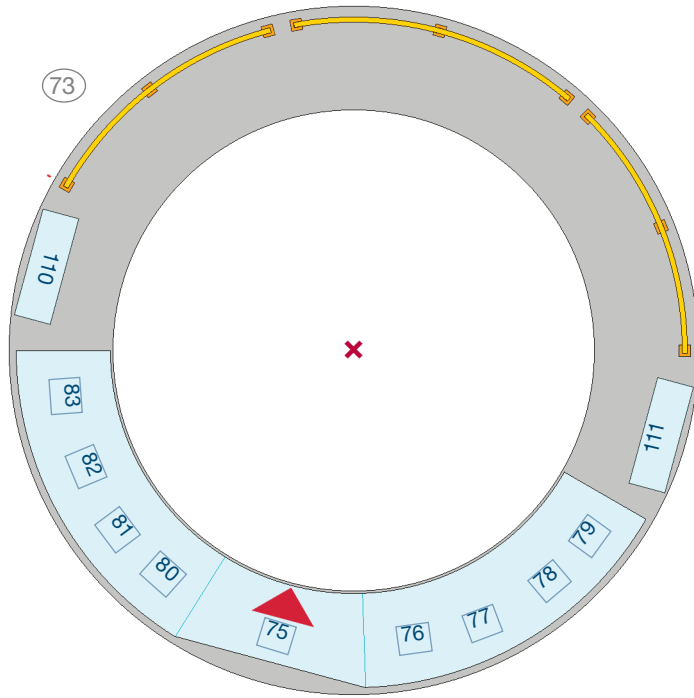

1 cm 1 inch

This page should be glued to cardboard before cutting out the pieces.

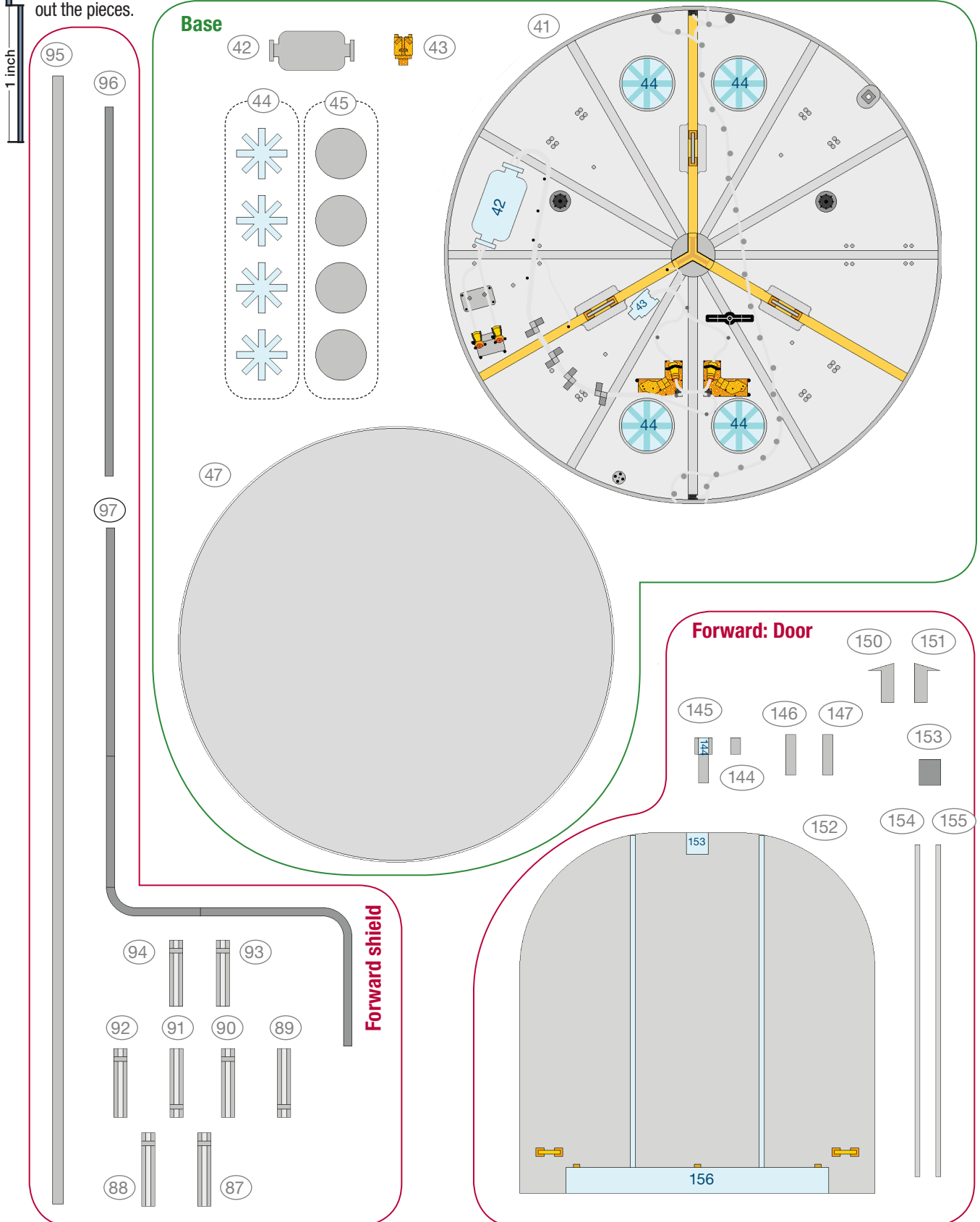

Forward shield

This page should be glued to cardboard before cutting out the pieces.

Cut out all sections marked with ✕

